

440182029

DEVELOPMENT DOCUMENT  
FOR FINAL  
EFFLUENT LIMITATIONS GUIDELINES,  
NEW SOURCE PERFORMANCE STANDARDS,  
AND  
PRETREATMENT STANDARDS  
FOR THE  
STEAM ELECTRIC  
POINT SOURCE CATEGORY

Anne M. Gorsuch  
Administrator

Jeffery Denit  
Director, Effluent Guidelines Division

Dennis Ruddy  
Project Officer

November 1982

Effluent Guidelines Division  
Office of Water and Waste Management  
U.S. Environmental Protection Agency  
Washington, D.C. 20460



TABLE OF CONTENTS

		<u>Page</u>
I	CONCLUSIONS.....	1
II	FINAL REGULATIONS.....	5
III	INTRODUCTION.....	29
	BACKGROUND.....	29
	PURPOSE.....	29
	INFORMATION AVAILABILITY, SOURCES AND COLLECTION.....	37
	INDUSTRY DESCRIPTION.....	41
	PROCESS DESCRIPTION.....	46
	ALTERNATE PROCESSES UNDER ACTIVE DEVELOPMENT....	54
	FUTURE GENERATING SYSTEMS.....	56
IV	INDUSTRY CATEGORIZATION.....	59
	STATISTICAL ANALYSIS.....	60
	ENGINEERING TECHNICAL ANALYSIS.....	63
V	WASTE CHARACTERIZATION.....	67
	INTRODUCTION.....	67
	DATA COLLECTION.....	67
	COOLING WATER.....	75
	ASH HANDLING.....	132
	LOW VOLUME WASTES.....	189
	METAL CLEANING WASTES.....	208
	COAL PILE RUNOFF.....	228
VI	SELECTION OF POLLUTANT PARAMETERS.....	249
	ONCE THROUGH COOLING WATER.....	261

TABLE OF CONTENTS (CONTINUED)

	<u>Page</u>
	COOLING TOWER BLOWDOWN..... 264
	COAL PILE RUNOFF..... 271
VII	TREATMENT AND CONTROL TECHNOLOGY..... 275
	INTRODUCTION..... 275
	ONCE-THROUGH COOLING WATER..... 275
	RECIRCULATING COOLING WATER..... 326
	ASH HANDLING..... 336
	LOW-VOLUME WASTES..... 438
	METAL CLEANING WASTES..... 441
	COAL PILE AND CHEMICAL HANDLING RUNOFF..... 455
VIII	COST, ENERGY, AND NON-WATER QUALITY ASPECTS..... 457
	COOLING WATER..... 457
	ASH HANDLING..... 464
	LOW VOLUME-WASTES..... 477
	COAL PILE RUNOFF..... 481
IX	BEST AVAILABLE TECHNOLOGY ECONOMICALLY ACHIEVABLE GUIDELINES AND LIMITATIONS, NEW SOURCE PERFORMANCE STANDARDS, AND PRETREATMENT STANDARDS..... 487
X	ACKNOWLEDGEMENTS..... 503
XI	REFERENCES..... 506
XII	GLOSSARY..... 518

TABLE OF CONTENTS (CONTINUED)

		<u>Page</u>
APPENDIX		
A	TVA RAW RIVER INTAKE AND ASH POND DISCHARGE DATA.....	A-1
B	CHLORINE MINIMIZATION PROGRAM FOR ONCE- THROUGH COOLING WATER.....	B-1
C	STATISTICAL EVALUATION OF CHLORINE MINIMIZA- TION AND DECHLORINATION.....	C-1
D	INDUSTRY COMPLIANCE WITH CHLORINATION OPTION....	D-1

LIST OF TABLES

<u>Number</u>		<u>Page</u>
II-1	TECHNOLOGIES EVALUATED AS CAPABLE OF ACHIEVING LIMITATIONS.....	6
III-1	LIST OF SIXTY-FIVE CLASSES OF POLLUTANTS CONTAINED IN SETTLEMENT AGREEMENT BETWEEN EPA AND NRDC.....	30
III-2	LIST OF 126 PRIORITY POLLUTANTS.....	32
III-3	DISTRIBUTION OF THE STEAM SECTION RELATIVE TO THE ENTIRE ELECTRIC UTILITY INDUSTRY AS OF 1978.	43
III-4	YEAR-END 1978 DISTRIBUTION OF STEAM ELECTRIC PLANTS BY SIZE CATEGORY.....	44
III-5	PRESENT AND FUTURE CAPACITY OF THE ELECTRIC UTILITY INDUSTRY.....	45
III-6	NUMBER OF EXISTING STEAM-ELECTRIC POWERPLANTS BY FUEL TYPE AND SIZE.....	47
III-7	CAPACITY OF EXISTING AND NEW STEAM-ELECTRIC POWERPLANTS BY FUEL TYPE AND SIZE.....	48
III-8	EXISTING AND PROJECTED DISTRIBUTION OF STEAM ELECTRIC POWERPLANTS BY FUEL TYPE.....	49
III-9	DISTRIBUTION OF STEAM-ELECTRIC CAPACITY BY PLANT SIZE AND IN-SERVICE YEAR.....	50
IV-1	VARIABLES FOUND TO HAVE A STATISTICALLY SIGNIFICANT INFLUENCE ON NORMALIZED FLOW DISCHARGES.....	61
IV-2	PERCENT OF THE VARIATION IN NORMALIZED DISCHARGE FLOWS THAT IS EXPLAINED BY THE INDEPENDENT VARIABLES.....	62

LIST OF TABLES (Continued)

<u>Number</u>		<u>Page</u>
V-1	CHARACTERISTICS OF PLANTS SAMPLED IN THE SCREEN SAMPLING PHASE OF THE SAMPLING PROGRAM...	70
V-2	CHARACTERISTICS OF PLANTS SAMPLED IN THE VERIFICATION PHASE.....	72
V-3	SUMMARY TABLE OF ALL PRIORITY POLLUTANTS DETECTED IN ANY OF THE WASTE STREAMS FROM STEAM ELECTRIC POWERPLANTS BASED ON THE ANALYSIS OF THE COMPLETE COMPUTERIZED DATA BASE.....	76
V-4	ONCE-THROUGH COOLING WATER FLOW RATES.....	78
V-5	COOLING TOWER BLOWDOWN.....	83
V-6	COPPER CORROSION DATA.....	95
V-7	ONE YEAR STEADY STATE CORROSION RATES FOR ALLOY 706 DETERMINED EXPERIMENTALLY.....	97
V-8	SELECTED PRIORITY POLLUTANT CONCENTRATIONS IN SEAWATER BEFORE AND AFTER PASSAGE THROUGH ONCE-THROUGH COOLING WATER SYSTEM.....	98
V-9	SOLUBLE COPPER CONCENTRATIONS IN RECIRCULATING COOLING WATER SYSTEMS.....	99
V-10	COMMONLY USED CORROSION AND SCALING CONTROL CHEMICALS.....	100
V-11	SOLVENT OR CARRIER COMPONENTS THAT MAY BE USED IN CONJUNCTION WITH SCALING AND CORROSION CONTROL AGENTS.....	104
V-12	POLLUTANTS REPORTED ON 308 FORMS IN COOLING TOWER BLOWDOWN.....	105
V-13	ASBESTOS IN COOLING TOWER WATERS.....	106
V-14	RESULTS OF SCREENING PROGRAM FOR ONCE-THROUGH COOLING WATER SYSTEMS.....	109
V-15	SUMMARY OF DATA FROM THE VERIFICATION PROGRAM AND EPA SURVEILLANCE AND ANALYSIS REPORTS FOR ONCE-THROUGH COOLING WATER SYSTEMS.....	110

LIST OF TABLES (Continued)

<u>Number</u>		<u>Page</u>
V-16	RESULTS OF THE SCREENING PHASE OF THE SAMPLING PROGRAM FOR COOLING TOWER BLOWDOWN.....	119
V-17	SUMMARY OF RESULTS OF VERIFICATION PROGRAM FOR RECIRCULATION COOLING WATER SYSTEMS.....	123
V-18	FLY ASH POND OVERFLOW.....	133
V-19	BOTTOM ASH POND OVERFLOW.....	134
V-20	VANADIUM, NICKEL, AND SODIUM CONTENT OF RESIDUAL FUEL OIL.....	136
V-21	AVERAGE PRODUCT YIELD OF A MODERN UNITED STATES REFINERY.....	137
V-22	SULFUR CONTENT IN FRACTIONS OF KUWAIT CRUDE OIL.....	138
V-23	MELTING POINTS OF SOME OIL/ASH CONSTITUENTS.....	140
V-24	MEGATONS OF COAL ASH COLLECTED IN THE UNITED STATES.....	142
V-25	VARIATIONS IN COAL ASH COMPOSITION WITH RANK.....	143
V-26	RANGE IN AMOUNT OF TRACE ELEMENTS PRESENT IN COAL ASHES.....	144
V-27	COMPARISON OF DISTRIBUTION BETWEEN BOTTOM ASH AND FLY ASH BY TYPE OF BOILERS AND METHOD OF FIRING.....	149
V-28	MAJOR CHEMICAL CONSTITUENTS OF FLY ASH AND BOTTOM ASH FROM THE SOUTHWESTERN PENNSYLVANIA REGIONS.....	150
V-29	COMPARISON OF FLY ASH AND BOTTOM ASH FROM VARIOUS UTILITY PLANTS.....	151
V-30	CONCENTRATIONS OF SELECTED TRACE ELEMENTS IN COAL AND ASH AT PLANT 4710.....	153



LIST OF TABLES (Continued)

<u>Number</u>		<u>Page</u>
V-31	ELEMENTS SHOWING PRONOUNCED CONCENTRATION TRENDS WITH DECREASING PARTICLE SIZE.....	156
V-32	CHARACTERISTICS OF ASH POND OVERFLOW WITH TOTAL SUSPENDED SOLIDS CONCENTRATIONS LESS THAN 30 ng/l.....	157
V-33	SUMMARY OF ASH POND OVERFLOW DATA FROM DISCHARGE MONITORING REPORTS.....	158
V-34	SUMMARY OF QUARTERLY TVA TRACE METAL DATA FOR ASH POND INTAKE AND EFFLUENT STREAMS.....	159
V-35	SUMMARY OF PLANT OPERATION CONDITIONS AND ASH CHARACTERISTICS OF TVA COAL-FIRED POWER PLANTS.....	165
V-36	NUMBER OF ASH PONDS IN WHICH AVERAGE EFFLUENT CONCENTRATIONS OF SELECTED TRACE ELEMENTS EXCEED THOSE OF THE INTAKE WATER.....	166
V-37	SUMMARY OF QUARTERLY TRACE METAL DATA FOR ASH POND INTAKE AND EFFLUENT STREAMS.....	167
V-38	SUMMARY OF PLANT OPERATING CONDITIONS AND ASH CHARACTERISTICS OF TVA COAL-FIRED POWERPLANTS....	170
V-39	ASH POND EFFLUENT TRACE ELEMENT CONCENTRATIONS.....	172
V-40	SCREENING DATA FOR ASH POND OVERFLOW.....	173
V-41	SUMMARY OF DATA FROM THE VERIFICATION PROGRAM AND EPA SURVEILLANCE AND ANALYSIS REPORTS FOR ASH POND OVERFLOW.....	176
V-42	CONDITIONS UNDER WHICH ARSENIC IN ASH POND OVERFLOW EXCEEDS 0.05 ng/l.....	187
V-43	ARSENIC CONCENTRATIONS IN ASH POND EFFLUENTS.....	188
V-44	RECOMMENDED LIMITS OF TOTAL SOLIDS IN BOILER WATER FOR DRUM BOILERS.....	190

LIST OF TABLES (Continued)

<u>Number</u>		<u>Page</u>
V-45	CHEMICAL ADDITIVES COMMONLY ASSOCIATED WITH INTERNAL BOILER TREATMENT.....	191
V-46	STATISTICAL ANALYSIS OF BOILER BLOWDOWN CHARACTERISTICS.....	192
V-47	BOILER BLOWDOWN FLOWRATES.....	194
V-48	SURVEILLANCE AND ANALYSIS DATA FOR BOILER BLOWDOWN.....	195
V-49	COAGULATING AND FLOCCULATING AGENT CHARACTERISTICS.....	198
V-50	CLARIFIER BLOWDOWN FLOWRATES.....	199
V-51	FILTER BACKWASH FLOWRATES.....	200
V-52	ION EXCHANGE MATERIAL TYPES AND REGENERANT REQUIREMENT.....	202
V-53	ION EXCHANGE SPENT REGENERANT CHARACTERISTICS....	203
V-54	ION EXCHANGE SOFTENER SPENT REGENERANT FLOWRATES.....	204
V-55	LIME SOFTENER BLOWDOWN FLOWRATES.....	205
V-56	EVAPORATOR BLOWDOWN CHARACTERISTICS.....	206
V-57	EVAPORATOR BLOWDOWN FLOWRATES.....	207
V-58	REVERSE OSMOSIS BRINE FLOWRATES.....	209
V-59	EQUIPMENT DRAINAGE AND LEAKAGE.....	210
V-60	SURVEILLANCE AND ANALYSIS DATA FOR DEMINERALIZER REGENERANT.....	211
V-61	ALLOYS AND CONSTITUENTS OF BOILER SYSTEMS.....	217
V-62	WASTE CONSTITUENTS OF AMMONIATED CITRIC ACID SOLUTIONS.....	219
V-63	WASTE CONSTITUENTS OF AMMONIATED EDTA SOLUTIONS.....	220

LIST OF TABLES (Continued)

<u>Number</u>		<u>Page</u>
V-64	WASTE CONSTITUENTS OF AMMONIACAL SODIUM BROMATE SOLUTIONS.....	221
V-65	WASTE CONSTITUENTS OF HYDROCHLORIC ACID WITHOUT COPPER COMPLEXER SOLUTIONS.....	223
V-66	WASTE CONSTITUENTS OF HYDROCHLORIC ACID WITH COPPER COMPLEXER SOLUTIONS.....	225
V-67	WASTE CONSTITUENTS OF HYDROXYACETIC/FORMIC ACID SOLUTIONS.....	226
V-68	AVERAGE AND MAXIMUM CONCENTRATIONS AND LOADING IN RAW WASTEWATER FROM FIRESIDE WASHES AT PLANT 3306.....	229
V-69	WASTE LOAD DATA FOR BOILER FIRESIDE WASH.....	230
V-70	FIRESIDE WASH WATER FLOWRATES.....	231
V-71	AIR PREHEATER WASH WATER.....	232
V-72	WASTE LOAD DATA FOR AIR PREHEATER WASH.....	233
V-73	AIR PREHEATER WASHWATER FLOWRATES.....	234
V-74	CHARACTERISTICS OF COAL PILE RUNOFF.....	237
V-75	CONCENTRATIONS OF METALS IN COAL PILE RUNOFF.....	238
V-76	SUMMARY OF NEW AND RETROFIT FGD SYSTEMS BY PROCESS.....	240
V-77	COMPOSITION OF EFFLUENT FROM ONCE-THROUGH MIST ELIMINATOR WASH UNIT AT WET LIMESTONE SCRUBBER SYSTEM.....	242
V-78	RANGE OF CONCENTRATIONS OF CHEMICAL CONSTITUENTS IN FGD SLUDGES FROM LIME/LIMESTONE, AND DOUBLE- ALKALI SYSTEMS.....	245
V-79	FLUE GAS SCRUBBER BLOWDOWN.....	246
V-80	FLUE GAS SCRUBBER SOLIDS POND OVERFLOW.....	247

LIST OF TABLES (Continued)

<u>Number</u>		<u>Page</u>
VI-1	PRIORITY POLLUTANTS DETECTED IN THE SAMPLING PROGRAM BY WASTE STREAM SOURCES.....	251
VI-2	NUMBER OF PLANTS REPORTING VARIOUS PRIORITY POLLUTANTS AS KNOWN OR SUSPECTED TO BE PRESENT IN VARIOUS WASTE STREAMS.....	256
VI-3	PRIORITY POLLUTANT CONTAINING PROPRIETARY CHEMICALS USED BY POWER PLANTS.....	259
VII-1	SUMMARY OF CHLORINE MINIMIZATION STUDIES AT POWER PLANTS USING ONCE-THROUGH COOLING SYSTEMS.....	297
VII-2	SULFUR DIOXIDE DECHLORINATION SYSTEMS IN USE OR UNDER CONSTRUCTION AT U.S. STEAM ELECTRIC PLANTS.....	310
VII-3	CHLORINATED CONDENSER OUTLET FIELD DATA FROM PLANT 0611.....	311
VII-4	UNCHLORINATED CONDENSER OUTLET FIELD DATA FROM PLANT 0611.....	312
VII-5	DECHLORINATED EFFLUENT DATA FIELD DATA FOR PLANT 0611.....	313
VII-6	DRY CHEMICAL DECHLORINATION SYSTEMS IN USE OR UNDER CONSTRUCTION AT U.S. STEAM ELECTRIC PLANTS.....	319
VII-7	CHLORINATION/DECHLORINATION PRACTICES.....	321
VII-8	EFFECT OF DRY CHEMICAL DECHLORINATION ON PH OF THE COOLING WATER.....	324
VII-9	EFFECT OF DRY CHEMICAL DECHLORINATION ON DISSOLVED OXYGEN IN COOLING WATER.....	325

LIST OF TABLES (Continued)

<u>Number</u>		<u>Page</u>
VII-10	CORROSION AND SCALING CONTROL MIXTURES KNOWN TO CONTAIN PRIORITY POLLUTANTS.....	330
VII-11	COMMONLY USED OXIDIZING BIOCIDES.....	332
VII-12	COMMONLY USED NON-OXIDIZING BIOCIDES.....	333
VII-13	ASH CONVEYING CAPACITIES OF VARIOUS SIZE PIPES...	346
VII-14	PLANTS WITH RETROFITTED DRY FLY ASH HANDLING SYSTEMS.....	368
VII-15	ARSENIC REMOVAL FROM MUNICIPAL WASTEWATERS.....	383
VII-16	SUMMARY OF NICKEL CONCENTRATIONS IN METAL PROCESSING AND PLATING WASTEWATERS.....	385
VII-17	SUMMARY OF EFFLUENT NICKEL CONCENTRATIONS AFTER PRECIPITATION TREATMENT.....	386
VII-18	CONCENTRATIONS OF ZINC IN PROCESS WASTEWATERS....	387
VII-19	SUMMARY OF PRECIPITATION TREATMENT RESULTS FOR ZINC.....	388
VII-20	COPPER CONCENTRATIONS IN WASTEWATER FROM METAL PLATING AND PROCESSING OPERATIONS.....	389
VII-21	COPPER REMOVAL BY FULL-SCALE INDUSTRIAL WASTEWATER TREATMENT SYSTEMS.....	392
VII-22	COMPARISON OF INITIAL TRACE METAL CONCENTRATIONS CITED IN STUDIES REPORTED IN THE LITERATURE AND TRACE METAL CONCENTRATIONS IN ASH POND DISCHARGES.....	394
VII-23	TRACE METAL REMOVAL EFFICIENCIES FOR LIME PRECIPITATION TREATMENT OF ASH POND EFFLUENTS....	395
VII-24	TRACE METAL REMOVAL EFFICIENCIES FOR LIME PLUS FERRIC SULFATE PRECIPITATION TREATMENT OF ASH POND EFFLUENTS.....	396

LIST OF TABLES (Continued)

<u>Number</u>		<u>Page</u>
VII-25	DATA SUMMARY OF PLANTS REPORTING ZERO DISCHARGE OF BOTTOM ASH TRANSPORT WATER.....	408
VII-26	TRACE ELEMENTS/PRIORITY POLLUTANTS CONCENTRATIONS AT PLANT 3203.....	419
VII-27	MAJOR SPECIES CONCENTRATION AT PLANT 3203.....	420
VII-28	TRACE ELEMENTS PRIORITY POLLUTANTS CONCENTRATIONS AT PLANT 0822.....	425
VII-29	MAJOR SPECIES CONCENTRATIONS AT PLANT 0822.....	426
VII-30	TRACE ELEMENTS PRIORITY POLLUTANTS CONCENTRATIONS AT PLANT 1811.....	431
VII-31	MAJOR SPECIES POLLUTANTS CONCENTRATIONS AT PLANT 1811.....	432
VII-32	TRACE ELEMENTS/PRIORITY POLLUTANTS CONCENTRATIONS AT PLANT 1809.....	436
VII-33	MAJOR SPECIES CONCENTRATIONS AT PLANT 1809.....	437
VII-34	TREATMENT OF ACID CLEANING WASTEWATER SUMMARY OF JAR TESTS.....	452
VII-35	EQUIVALENT TREATMENT OF INCINERATION TESTS.....	454
VII-36	PHYSICAL/CHEMICAL TREATMENT PROCESSES AND EFFICIENCIES.....	456
VIII-1	SUMMARY OF COST, ENERGY, AND LAND REQUIREMENTS FOR CHLORINE MINIMIZATION IN ONCE-THROUGH COOLING WATER SYSTEMS.....	458
VIII-2	SUMMARY OF COST, ENERGY, AND LAND REQUIREMENTS FOR DECHLORINATION IN ONCE-THROUGH COOLING WATER SYSTEMS.....	458

LIST OF TABLES (Continued)

<u>Number</u>		<u>Page</u>
VIII-3	SUMMARY COST, ENERGY AND LAND REQUIREMENTS FOR DECHLORINATION OF RECIRCULATING COOLING SYSTEM DISCHARGE (BLOWDOWN).....	460
VIII-4	SUMMARY COST, ENERGY AND LAND REQUIREMENTS FOR SWITCHING TO NON-PRIORITY POLLUTANT CONTAINING NON-OXIDIZING BIOCIDES.....	461
VIII-5	SUMMARY COST, ENERGY AND LAND REQUIREMENTS FOR SWITCHING TO NON-PRIORITY POLLUTANT CONTAINING CORROSION AND SCALE CONTROL CHEMICALS.....	461
VIII-6	COOLING TOWER FILL REPLACEMENT COSTS.....	463
VIII-7	ANNUALIZED COSTS, DRY VS. WET FLY ASH DISPOSAL...	465
VIII-8	CAPITAL COSTS FOR NEW SOURCE DRY FLY ASH HANDLING SYSTEMS.....	466
VIII-9	ENERGY REQUIREMENTS FOR NEW SOURCE DRY FLY ASH HANDLING SYSTEMS.....	468
VIII-10	LAND REQUIREMENTS FOR NEW SOURCE DRY FLY ASH HANDLING SYSTEMS.....	468
VIII-11	CAPITAL COSTS FOR CHEMICAL PRECIPITATION OF ONCE-THROUGH FLY ASH SLUICING SYSTEMS.....	470
VIII-12	ENERGY REQUIREMENTS FOR NEW SOURCE WET CHEMICAL PRECIPITATION OF ONCE-THROUGH FLY ASH SLUICING SYSTEMS.....	471
VIII-13	LAND REQUIREMENTS FOR NEW SOURCE CHEMICAL PRECIPITATION OF ONCE-THROUGH FLY ASH HANDLING SYSTEMS.....	471
VIII-14	CAPITAL COSTS FOR COMPLETE RECYCLE BOTTOM ASH HANDLING SYSTEM.....	473
VIII-15	OPERATING AND MAINTENANCE COSTS FOR COMPLETE RECYCLE BOTTOM ASH HANDLING SYSTEM.....	475

LIST OF TABLES (Continued)

<u>Number</u>		<u>Page</u>
VIII-16	ENERGY REQUIREMENTS FOR COMPLETE RECYCLE BOTTOM ASH HANDLING SYSTEM.....	475
VIII-17	LAND REQUIREMENTS FOR COMPLETE RECYCLE BOTTOM ASH HANDLING SYSTEM.....	476
VIII-18	CAPITAL COSTS FOR PARTIAL RECYCLE BOTTOM ASH HANDLING SYSTEM.....	476
VIII-19	OPERATING AND MAINTENANCE COSTS FOR PARTIAL RECYCLE BOTTOM ASH HANDLING SYSTEM.....	478
VIII-20	ANNUAL ENERGY REQUIREMENTS FOR PARTIAL RECYCLE BOTTOM ASH HANDLING SYSTEM.....	478
VIII-21	LAND REQUIREMENTS FOR PARTIAL RECYCLE BOTTOM ASH HANDLING SYSTEMS.....	479
VIII-22	IMPOUNDMENT COST.....	479
VIII-23	COST OF VAPOR COMPRESSION EVAPORATION SYSTEM.....	480
VIII-24	COST OF EVAPORATION PONDING.....	480
VIII-25	COST OF SPRAY DRYING SYSTEM.....	483
VIII-26	COST OF IMPOUNDMENT FOR COAL PILE RUNOFF.....	483
VIII-27	COST OF LIME FEED SYSTEM.....	484
VIII-28	COST OF MIXING EQUIPMENT.....	484
VIII-29	CLARIFICATION.....	485
VIII-30	COST FOR LIME FEED SYSTEM.....	485
VIII-31	COST OF POLYMER FEED SYSTEM.....	486
VIII-32	COST OF ACID FEED SYSTEM.....	486
A-1	TVA PLANT A RIVER WATER INTAKE AND FLY ASH POND DISCHARGE DATA.....	A-1
A-2	TVA PLANT A RIVER WATER INTAKE AND BOTTOM ASH POND DISCHARGE DATA.....	A-5



LIST OF TABLES (Continued)

<u>Number</u>		<u>Page</u>
A-3	TVA PLANT B RIVER WATER INTAKE AND FLY ASH POND DISCHARGE DATA.....	A-9
A-4	TVA PLANT B RIVER WATER INTAKE AND BOTTOM ASH POND DISCHARGE DATA.....	A-12
A-5	TVA PLANT C RIVER WATER INTAKE AND COMBINED ASH POND (EAST) DISCHARGE DATA.....	A-15
A-6	TVA PLANT C RIVER WATER INTAKE AND COMBINED ASH POND (WEST) DISCHARGE DATA.....	A-19
A-7	TVA PLANT D RIVER WATER INTAKE AND COMBINED ASH POND DISCHARGE DATA.....	A-23
A-8	TVA PLANT E RIVER WATER INTAKE AND COMBINED ASH POND DISCHARGE DATA.....	A-27
A-9	TVA PLANT F RIVER WATER INTAKE AND COMBINED ASH POND DISCHARGE DATA.....	A-31
A-10	TVA PLANT G RIVER WATER INTAKE AND COMBINED ASH POND DISCHARGE DATA.....	A-35
A-11	TVA PLANT H RIVER WATER INTAKE AND COMBINED ASH POND DISCHARGE DATA.....	A-39
A-12	TVA PLANT H RIVER WATER INTAKE AND FLY ASH POND DISCHARGE DATA.....	A-42
A-13	TVA PLANT H RIVER WATER INTAKE AND BOTTOM ASH POND DISCHARGE DATA.....	A-43
A-14	TVA PLANT I RIVER WATER INTAKE AND COMBINED ASH POND (SOUTH) DISCHARGE.....	A-44
A-15	TVA PLANT J RIVER WATER INTAKE AND COMBINED ASH POND DISCHARGE.....	A-48
A-16	TVA PLANT K RIVER WATER INTAKE AND COMBINED ASH POND DISCHARGE.....	A-52
A-17	TVA PLANT L RIVER WATER INTAKE AND COMBINED ASH POND DISCHARGE.....	A-56

LIST OF TABLES (Continued)

<u>Number</u>		<u>Page</u>
C-1	RECOMMENDED STANDARDS: TRC (mg/l).....	C-1
C-2	THE NUMBER OF OF CHLORINATION EVENTS.....	C-2
C-3	PERCENTAGE OF AVERAGE (X) AND MAXIMUM (MAX.) VALUES EQUALING ZERO.....	C-3
C-5	WEIGHTED MEAN: TRC (mg/l).....	C-7
C-6	STANDARD DEVIATION.....	C-11
C-7	WEIGHTED MEANS AND MEDIAN OF ESTIMATED STANDARD DEVIATION FOR TREATMENT TYPE (PLANT INDEPENDENT).....	C-12
C-8	COMPUTATION OF $.99^{n1}$ .....	C-13
C-9	99th PERCENTILE ESTIMATES FOR A DAILY MAXIMUM....	C-13
D-1	SUMMARY OF CHLORINE MINIMIZATION STUDIES AT POWER PLANTS USING ONCE-THROUGH COOLING SYSTEMS.....	D-2

## LIST OF FIGURES

<u>Figure</u>		<u>Page</u>
III-1	TYPICAL COAL-FIRED STEAM ELECTRIC PLANT.....	53
V-1	SOURCES OF WASTEWATER IN A FOSSIL-FUELED STEAM ELECTRIC POWER PLANT.....	68
V-2	SHELL AND TUBE CONDENSER.....	77
V-3	MECHANICAL DRAFT COOLING TOWERS.....	80
V-4	NATURAL DRAFT EVAPORATIVE COUNTERFLOW COOLING TOWER.....	81
V-5	EFFECT OF pH ON THE DISTRIBUTION OF HYPOCHLOROUS ACID AND HYPOCHLORITE ION IN WATER.....	85
V-6	EFFECT OF IMPURITIES IN WATER ON TOTAL AVAILABLE CHLORINE RESIDUAL.....	88
V-7	FREQUENCY DISTRIBUTION OF HALOGENATED ORGANICS IN RAW AND FINISHED DRINKING WATER.....	89
V-8	EFFECT OF WATER TEMPERATURE ON THE CHLOROFORM REACTION.....	91
V-9	EFFECT OF pH ON THE CHLOROFORM REACTION.....	92
V-10	EFFECT OF CONTACT TIME ON THE CHLOROFORM REACTION.....	93
V-11	PULVERIZED-COAL FIRING METHODS.....	148
V-12	GRAIN SIZE DISTRIBUTION CURVES FOR BOTTOM ASH AND FLY ASH.....	155
VII-1	SIMPLIFIED, SCHEMATIC DIAGRAM OF A CHLORINE DIOXIDE BIOFOULING CONTROL FACILITY BASED ON THE CHLORINE GAS METHOD.....	278
VII-2	SIMPLIFIED, SCHEMATIC DIAGRAM OF A CHLORINE DIOXIDE BIOFOULING CONTROL FACILITY BASED ON THE HYPOCHLORITE METHOD.....	280
VII-3	SCHEMATIC DIAGRAM OF CORONA CELL.....	282

LIST OF FIGURES (Continued)

<u>Figure</u>		<u>Page</u>
VII-4	EFFECT OF OZONATION OF FACILITY CAPACITY ON PROCESS CHOICE - OXYGEN VS. AIR.....	284
VII-5	OZONATION FACILITY USING AIR TO GENERATE OZONE... ..	285
VII-6	OZONATION FACILITY USING OXYGEN TO GENERATE OZONE.....	286
VII-7	LIQUID SUPPLY CHLORINATION SYSTEM.....	290
VII-8	SCHEMATIC DIAGRAM OF A TYPICAL CHLORINATOR.....	291
VII-9	PROCEDURE FOR CONDUCTING A SET OF SCREENING TRIALS TO CONVERGE ON THE MINIMUM VALUE FOR TRC LEVEL, DURATION OF CHLORINATION, AND CHLORINATION FREQUENCY.....	294
VII-10	DECHLORINATION BY NATURAL CHLORINE DEMAND IN A ONCE-THROUGH COOLING WATER SYSTEM.....	301
VII-11	SCHEMATIC ARRANGEMENT OF AMERTAP TUBE CLEANING SYSTEM.....	303
VII-12	SCHEMATIC OF M.A.N. SYSTEM REVERSE FLOW PIPING.....	304
VII-13	FLOW DIAGRAM FOR DECHLORINATION BY SULFUR DIOXIDE (SO <sub>2</sub> ) INJECTION.....	307
VII-14	FLOW DIAGRAM FOR DECHLORINATION BY DRY CHEMICAL INJECTION.....	318
VII-15	DRY FLY ASH HANDLING - VACUUM SYSTEM.....	339
VII-16	DIAGRAM OF A HYDRAULIC VACUUM PRODUCER.....	341
VII-17	TYPE "E" DUST VALVES.....	342
VII-18	SEGREGATING VALVES.....	343
VII-19	TYPICAL PIPES AND FITTINGS FOR ASH CONVEYING.....	344
VII-20	DRY FLY ASH HANDLING SYSTEM - PRESSURE SYSTEM.....	348
VII-21	TYPICAL AIR LOCK VALVE FOR PRESSURE FLY ASH CONVEYING SYSTEM.....	350

LIST OF FIGURES (Continued)

<u>Figure</u>		<u>Page</u>
VII-22	FLY ASH SILO AND HOPPERS/PLANT 1811.....	353
VII-23	FLOW DIAGRAM FOR PLANT 0822.....	355
VII-24	PRESSURE FLY ASH HANDLING SYSTEM FOR PLANT 3203..	357
VII-25	DISTRIBUTION OF FLY ASH HANDLING SYSTEMS BY MAJOR FUEL TYPES.....	359
VII-26	DISTRIBUTION OF FLY ASH HANDLING SYSTEMS BY COAL TYPE.....	360
VII-27	DISTRIBUTION OF FLY ASH HANDLING SYSTEMS BY MAJOR BOILER TYPES.....	362
VII-28	DISTRIBUTION OF FLY ASH HANDLING SYSTEMS BY EPA REGION.....	363
VII-29	EPA REGIONS.....	364
VII-30	DISTRIBUTION OF FLY ASH HANDLING SYSTEMS BY VARIOUS PLANT SIZES.....	366
VII-31	DISTRIBUTION OF FLY ASH HANDLING SYSTEMS AS A FUNCTION OF INTAKE WATER QUALITY.....	367
VII-32	GENERALIZED, SCHEMATIC DIAGRAM OF A PARTIAL RECIRCULATION FLY ASH HANDLING SYSTEM.....	369
VII-33	A TYPICAL METHOD OF SLUICING FLY ASH FROM COLLECTION POINTS.....	370
VII-34	TYPICAL AIR SEPARATOR IN A PARTIAL RECIRCULATING FLY ASH HANDLING SYSTEM.....	372
VII-35	ASH HANDLING SYSTEM FLOW DIAGRAM AND SAMPLING LOCATIONS FOR PLANT 1809.....	375
VII-36	FLOW DIAGRAM OF A TYPICAL PHYSICAL/CHEMICAL TREATMENT SYSTEM FOR METALS REMOVAL USING LIME...	377
VII-37	TYPICAL LIME FEED SYSTEM.....	378
VII-38	DEEP BED FILTER.....	380

LIST OF FIGURES (Continued)

<u>Figure</u>		<u>Page</u>
VII-39	LANDFILL METHODS.....	397
VII-40	VARIOUS STAGES OF A CLOSED-LOOP RECIRCULATING SYSTEM.....	399
VII-41	PONDING RECYCLE SYSTEM FOR BOTTOM ASH.....	405
VII-42	WATER FLOW DIAGRAM FOR PLANT 3203.....	414
VII-43	BOTTOM ASH RECYCLE SYSTEM AT PLANT 3203.....	416
VII-44	BOTTOM ASH HANDLING SYSTEM FOR PLANT 8022.....	422
VII-45	PLANT 1811 FLOW DIAGRAM FOR BOTTOM ASH HANDLING..	428
VII-46	SIMPLIFIED, SCHEMATIC DIAGRAM OF A VAPOR COMPRESSION EVAPORATION UNIT.....	440
VII-47	TYPICAL PIPING DIAGRAM AND LOCATION FOR INCINERATION OF BOILER CHEMICAL CLEANING WASTES.....	443
VII-48	COMPLEXING OF Fe(III).....	446
VII-49	THE CHELATE EFFECT ON COMPLEX FORMATION OF Cu-aq <sup>2+</sup> WITH MONODENTATE, BIDENTATE AND TETRADENTATE AMINES.....	448
VII-50	TREATMENT SCHEME FOR METALS REMOVAL BY PRECIPITATION FROM WASTE BOILER CLEANING SOLUTION.....	449
VII-51	THEORETICAL SOLUBILITIES OF METAL IONS AS A FUNCTION OF pH.....	451
C-1	HISTOGRAMS FOR PLANT 2608.....	C-4
C-2	HISTOGRAMS FOR PLANT 2607.....	C-5
C-3	HISTOGRAMS FOR PLANT 2603.....	C-6
C-4	EMPIRICAL DISTRIBUTION FUNCTIONS FOR PLANT 2608..	C-8
C-5	EMPIRICAL DISTRIBUTION FUNCTIONS FOR PLANT 2607..	C-9
C-6	EMPIRICAL DISTRIBUTION FUNCTIONS FOR PLANT 2603..	C-10

## SECTION I

### CONCLUSIONS

In revising effluent limitations guidelines, standards of performance for new sources, and pretreatment standards for the steam electric power generating industry, separate consideration has been given to heat and to chemical pollutants. In this regulation, only nonthermal-related pollutants were considered.

The analysis of pollutants and the technologies applicable to their control were based on specific waste streams of concern. These waste streams are primarily a function of fuels used, processes employed, plant site characteristics, and intake water quality. The major waste streams have been defined as direct or indirect products of the treatment system, power cycle system, ash handling system, air pollution control system, coal pile, yard and floor drainage, condenser cooling system and miscellaneous sources. Virtually all steam electric facilities have one or more waste streams associated with these systems and sources.

This review of effluent guidelines focused primarily on the 126 priority pollutants, although other pollutants were also considered. In general, very few of the organics in the list of 126 priority pollutants were detected in quantifiable amounts. Inorganic priority pollutants, however, are found in most waste streams. This review also disclosed that the chlorine (a non-conventional pollutant) limitations in the existing guidelines are not sufficiently stringent.

Treatment and control technologies currently in use by certain segments of the power industry could be applied to a greater number of power plants, reducing the discharge of pollutants. The best practicable control technology currently available (BPTCA) is not changed with exception to provisions relating to boiler blowdown and allowing concentration-based permit limitations to be established. The best available technology economically achievable (BATEA), new source performance standards (NSPS) and pretreatment standards for new (PSNS) and existing sources (PSES) are changed to reflect updated information on control technology, waste characterization and other factors.

In summary, the final regulations are as follows:

1. For once through cooling water, EPA is promulgating BAT and NSPS based upon a concentration of 0.2 mg/l total residual chlorine (TRC), applied at the final discharge point to the receiving body of water. Each individual generating unit is

not allowed to discharge chlorine for more than two hours per day, unless the discharger demonstrates to the permitting authority that a longer duration discharge is required for macroinvertebrate control. Simultaneous chlorination of more than one generating unit is allowed.

The above limitation does not apply to plants with a total rated generating capacity of less than 25 megawatts. BAT and NSPS are equal to BPT for those plants.

With the exception of a prohibition on the discharge of PCBs, there are no national pretreatment standards applicable to once-through cooling water.

2. For cooling tower blowdown, the Agency is retaining the existing BPT requirements for BAT and NSPS on free available chlorine. These limitations are 0.2 mg/l average concentration and 0.5 mg/l daily maximum concentration, with multi-unit chlorination prohibited. The final BAT, NSPS, and pretreatment standards also prohibit the discharge in detectable amounts of 124 priority pollutants contained in cooling tower maintenance chemicals, retain the existing limits on chromium and zinc discharges, and delete the limits on phosphorus.

3. For fly ash transport water, there are no BAT limits or PSES with the exception of a prohibition of PCB discharges. The existing BAT limits for conventional pollutants are withdrawn because they will be covered by Best Conventional Pollutant Control Technology (BCT) limitations. Final NSPS and PSNS for fly ash transport require no discharge of wastewater pollutants. This is based upon dry fly ash handling and disposal.

4. For bottom ash transport water, there are no BAT limits or pretreatment standards, with the exception of a prohibition on PCB discharges. NSPS is revised to equal BPT; the existing recycle requirement is withdrawn. The existing BAT limits for conventional pollutants are withdrawn because they will be covered by BCT.

5. For low volume wastes, the BAT limits for conventional pollutants are withdrawn because they will be covered by BCT. All other existing requirements are retained. Boiler blowdown is now regulated as a low volume waste, and no longer regulated separately.

6. For chemical metal cleaning wastes, the existing BAT and NSPS regulations are retained. The existing BAT limits for conventional pollutants are withdrawn because they will be covered by BCT. Final PSES and PSNS contain a maximum concentration limit of 1.0 mg/l for total copper.



7. BAT, NSPS, PSES, and PSNS for non-chemical metal cleaning wastes, wet air pollution control devices, chemical handling area runoff, and ash pile/construction area runoff are reserved for future rulemaking.

8. For coal pile runoff, the existing limits are retained, except that BAT is withdrawn for conventional pollutants.

9. BCT is reserved for all wastestreams.



## SECTION II

### FINAL REGULATIONS

All effluent limitations guidelines, standards of performance for new sources and pretreatment standards for the steam electric power generating point source category are reprinted from 40 CFR Part 423 below. The technologies available to achieve these guidelines are presented in table II-1.

#### §423.10 Applicability.

The provisions of this part are applicable to discharges resulting from the operation of a generating unit by an establishment primarily engaged in the generation of electricity for distribution and sale which results primarily from a process utilizing fossil-type fuel (coal, oil, or gas) or nuclear fuel in conjunction with a thermal cycle employing the steam-water system as the thermodynamic medium.

#### §423.11 Specialized definitions.

In addition to the definitions set forth in 40 CFR Part 401, the following definitions apply to this part:

(a) The term "total residual chlorine" (or total residual oxidants for intake water with bromides) means the value obtained using the amperometric method for total residual chlorine described in 40 CFR Part 136.

(b) The term "low volume waste sources" means, taken collectively as if from one source, wastewater from all sources except those for which specific limitations are otherwise established in this part. Low volume wastes sources include, but are not limited to: wastewaters from wet scrubber air pollution control systems, ion exchange water treatment system, water treatment evaporator blowdown, laboratory and sampling streams, boiler blowdown, floor drains, cooling tower basin cleaning wastes, and recirculating house service water systems. Sanitary and air conditioning wastes are not included.

(c) The term "chemical metal cleaning waste" means any wastewater resulting from the cleaning of any metal process equipment with chemical compounds, including, but not limited to, boiler tube cleaning.

(d) The term "metal cleaning waste" means any wastewater resulting from cleaning [with or without chemical cleaning compounds] any metal process equipment including, but not limited to, boiler tube cleaning, boiler fireside cleaning, and air preheater cleaning.

Table II-1

## TECHNOLOGIES EVALUATED AS CAPABLE OF ACHIEVING LIMITATIONS

<u>Wastestreams</u>	<u>BAT: Existing Sources</u>	<u>Standards of Performance: New Sources</u>	<u>Pretreatment Standards: Existing Sources</u>	<u>Pretreatment Standards: New Sources</u>
Once-Through Cooling Water	Chlorine Minimization-Dechlorination	Chlorine Minimization-Dechlorination		
Cooling Tower Blowdown	Use of alternative chemicals	Use of alternative chemicals/chemical precipitation	Use of alternative chemicals	Use of alternative chemicals
Bottom Ash Transport Water		Sedimentation		
Fly Ash Transport Water		Dry transport and disposal		Dry trans- port and disposal
Chemical Metal Clean- ing Wastes	Chemical Precipitation	Chemical Precipitation	Chemical Precipi- tation	Chemical Precipita- tion
Non-chemical Cleaning Wastes	Reserved for future con- sideration	Reserved for future con- sideration	Reserved for future con- sideration	Reserved for future con- sideration
Low Volume Waste (includes boiler blowdown)		Sedimentation	Sedimentation	Sedimenta- tion

Table II-1 (Continued)

TECHNOLOGIES EVALUATED AS CAPABLE OF ACHIEVING LIMITATIONS

<u>Wastestreams</u>	<u>BAT: Existing Sources</u>	<u>Standards of Performance: New Sources</u>	<u>Pretreatment Standards: Existing Sources</u>	<u>Pretreatment Standards: New Sources</u>
Ash Pile/ Construction Runoff	Reserved for future considera- tion	Reserved for future con- sideration	Reserved for future considera- tion	Reserved for future con- sideration
Coal Pile- Runoff	pH adjustment, sedimentation	pH adjustment, sedimentation	pH adjustment, sedimentation	pH adjust- ment, sedi- mentation
Discharges from Wet Air Pollution Control Devices	Reserved for future considera- tion	Reserved for future con- sideration	Reserved for future considera- tion	Reserved for future con- sideration

(e) The term "fly ash" means the ash that is carried out of the furnace by the gas stream and collected by mechanical precipitators, electrostatic precipitators, and/or fabric filters. Economizer ash is included when it is collected with fly ash.

(f) The term "bottom ash" means the ash that drops out of the furnace gas stream in the furnace and in the economizer sections. Economizer ash is included when it is collected with bottom ash.

(g) The term "once through cooling water" means water passed through the main cooling condensers in one or two passes for the purpose of removing waste heat.

(h) The term "recirculated cooling water" means water which is passed through the main condensers for the purpose of removing waste heat, passed through a cooling device for the purpose of removing such heat from the water and then passed again, except for blowdown, through the main condenser.

(i) The term "10 year, 24/hour rainfall event" means a rainfall event with a probable recurrence interval of once in ten years as defined by the National Weather Service in Technical Paper No. 40. "Rainfall Frequency Atlas of the United States," May 1961 or equivalent regional rainfall probability information developed therefrom.

(j) The term "blowdown" means the minimum discharge of recirculating water for the purpose of discharging materials contained in the water, the further buildup of which would cause concentration in amounts exceeding limits established by best engineering practices.

(k) The term "average concentration" as it relates to chlorine discharge means the average of analyses made over a single period of chlorine release which does not exceed two hours.

(l) The term "free available chlorine" shall mean the value obtained using the amperometric titration method for free available chlorine described in "Standard Methods for the Examination of Water and Wastewater," page 112 (13th edition).

(m) The term "coal pile runoff" means the rainfall runoff from or through any coal storage pile.

§423.12 Effluent limitations guidelines representing the degree of effluent reduction attainable by the application of the best practicable control technology currently available (BPTCA).

(a) In establishing the limitations set forth in this section, EPA took into account all information it was able to collect, develop and solicit with respect to factors (such as age and size of plant, utilization of facilities, raw materials, manufacturing processes, non-water quality environmental impacts, control and treatment technology available, energy requirements and costs) which can affect the industry subcategorization and effluent levels established. It is, however, possible that data which would affect these limitations have not been available and, as a result, these limitations should be adjusted for certain plants in this industry. An individual discharger or other interested person may submit evidence to the Regional Administrator (or to the State, if the State has the authority to issue NPDES permits) that factors relating to the equipment or facilities involved, the process applied, or other such factors related to such discharger are fundamentally different from the factors considered in the establishment of the guidelines. On the basis of such evidence or other available information, the Regional Administrator (or the State) will make a written finding that such factors are or are not fundamentally different for that facility compared to those specified in the Development Document. If such fundamentally different factors are found to exist, the Regional Administrator or the State shall establish for the discharger effluent limitations in the NPDES Permit either more or less stringent than the limitations established herein, to the extent dictated by such fundamentally different factors. Such limitations must be approved by the Administrator of the Environmental Protection Agency. The Administrator may approve or disapprove such limitations, specify other limitations, or initiate proceedings to revise these regulations. The phrase "other such factors" appearing above may include significant cost differentials. In no event may a discharger's impact on receiving water quality be considered as a factor under this paragraph.

(b) Any existing point source subject to this subpart must achieve the following effluent limitations representing the degree of effluent reduction by the application of the best practicable control technology currently available (BPTCA):

(1) The pH of all discharges, except once through cooling water, shall be within the range of 6.0 - 9.0.

(2) There shall be no discharge of polychlorinated biphenyl compounds such as those commonly used for transformer fluid.

(3) The quantity of pollutants discharged from low volume waste sources shall not exceed the quantity determined by multiplying the flow of low volume waste sources times the concentration listed in the following table:

---

Pollutant or Pollutant Property	Maximum for any one day (mg/l)	<u>BPT Effluent Limitations</u>
		Average of daily values for thirty consecutive days shall not exceed - (mg/l)
TSS	100.0	30.0
Oil and Grease	20.0	15.0

---

(4) The quantity of pollutants discharged in fly ash and bottom ash transport water shall not exceed the quantity determined by multiplying the flow of fly ash and bottom ash transport water times the concentration listed in the following table:

---

Pollutant or Pollutant Property	Maximum for any one day (mg/l)	<u>BPT Effluent Limitations</u>
		Average of daily values for thirty consecutive days shall not exceed - (mg/l)
TSS	100.0	30.0
Oil and Grease	20.0	15.0

---

(5) The quantity of pollutants discharged in metal cleaning wastes shall not exceed the quantity determined by multiplying the flow of metal cleaning wastes times the concentration listed in the following table:

---

Pollutant or Pollutant Property	Maximum for any one day (mg/l)	<u>BPT Effluent Limitations</u>
		Average of daily values for thirty consecutive days shall not exceed - (mg/l)
TSS	100.0	30.0
Oil and Grease	20.0	15.0
Copper, Total	1.0	1.0
Iron, Total	1.0	1.0

---



(6) The quantity of pollutants discharged in once through cooling water shall not exceed the quantity determined by multiplying the flow of once through cooling water sources times the concentration listed in the following table:

Pollutant or Pollutant Property	BPT Effluent Limitations	
	Maximum Concentration (mg/l)	Average Concentration (mg/l)
Free available chlorine	0.5	0.2

(7) The quantity of pollutants discharged in cooling tower blowdown shall not exceed the quantity determined by multiplying the flow of cooling tower blowdown sources times the concentration listed in the following table:

Pollutant or Pollutant Property	BPT Effluent Limitations	
	Maximum Concentration (mg/l)	Average Concentration (mg/l)
Free available chlorine	0.5	0.2

(8) Neither free available chlorine nor total residual chlorine may be discharged from any unit for more than two hours in any one day and not more than one unit in any plant may discharge free available or total residual chlorine at any one time unless the utility can demonstrate to the Regional Administrator or State, if the State has NPDES permit issuing authority, that the units in a particular location cannot operate at or below this level of chlorination.

(9) Subject to the provisions of paragraph (10) of this section, the following effluent limitations shall apply to the point source discharges of coal pile runoff:

Pollutant or Pollutant Property	BPT Effluent Limitations
	Maximum Concentration for any time (mg/l)
TSS	50

(10) Any untreated overflow from facilities designed, constructed, and operated to treat the volume of coal pile runoff which is associated with a 10 year, 24 hour rainfall event shall not be subject to the limitations in paragraph (9) of this section.

(11) At the permitting authority's discretion, the quantity of pollutant allowed to be discharged may be expressed as a concentration limitation instead of the mass based limitations specified in paragraphs (3) through (7) of this section. Concentration limitations shall be those concentrations specified in this section.

(12) In the event that waste streams from various sources are combined for treatment or discharge, the quantity of each pollutant or pollutant property controlled in paragraphs (1) through (11) of this section attributable to each controlled waste source shall not exceed the specified limitations for that waste source.

§423.13 Effluent limitations guidelines representing the degree of effluent reduction attainable by the application of the best available technology economically achievable (BATEA).

Except as provided in 40 CFR §§125.30-.32, any existing point source subject to this part must achieve the following effluent limitations representing the degree of effluent reduction attainable by the application of the best available technology economically achievable (BATEA).

(a) There shall be no discharge of polychlorinated biphenyl compounds such as those commonly used for transformer fluid.

(b)(1) For any plant with a total rated electric generating capacity of 25 or more megawatts, the quantity of pollutants discharged in once through cooling water from each discharge point shall not exceed the quantity determined by multiplying the flow of once through cooling water from each discharge point times the concentration listed in the following table:

Pollutant or Pollutant Property	<u>BPT Effluent Limitations</u>
	Maximum Concentration
Total residual chlorine	0.20 mg/l

(2) Total residual chlorine may not be discharged from any single generating unit for more than two hours per day unless the discharger demonstrates to the permitting authority that discharge for more than two hours is required for macroinvertebrate control. Simultaneous multi-unit chlorination is permitted.

(c)(1) For any plant with a total rated generating capacity of less than 25 megawatts, the quantity of pollutants discharged in once through cooling water shall not exceed the quantity determined by multiplying the flow of once through cooling water sources times the concentration listed in the following table:

Pollutant or Pollutant Property	BAT Effluent Limitations	
	Maximum Concentration (mg/l)	Average Concentration (mg/l)
Free available chlorine	0.5	0.2

(2) Neither free available chlorine nor total residual chlorine may be discharged from any unit for more than two hours in any one day and not more than one unit in any plant may discharge free available or total residual chlorine at any one time unless the utility can demonstrate to the Regional Administrator or State, if the State has NPDES permit issuing authority, that the units in a particular location cannot operate at or below this level of chlorination.

(d)(1) The quantity of pollutants discharged in cooling tower blowdown shall not exceed the quantity determined by multiplying the flow of cooling tower blowdown times the concentration listed below:

Pollutant or Pollutant Property	BAT Effluent Limitations	
	Maximum Concentration (mg/l)	Average Concentration (mg/l)
Free available chlorine	0.5	0.2

Pollutant or Pollutant Property	Maximum for any one day (mg/l)	Average of daily values for thirty consecutive days shall not exceed - (mg/l)
The 126 priority pollutants (Appendix A) contained in chemicals added for cooling tower maintenance, except:	No detectable amount	
Chromium, total	0.2	0.2
Zinc, total	1.0	1.0

(2) Neither free available chlorine nor total residual chlorine may be discharged from any unit for more than two hours in any one day and not more than one unit in any plant may discharge free available or total residual chlorine at any one time unless the utility can demonstrate to the Regional Administrator or State, if the State has NPDES permit issuing authority, that the units in a particular location cannot operate at or below this level of chlorination.

(3) At the permitting authority's discretion, instead of the monitoring specified in 40 CFR 122.11(b) compliance with the limitations for the 126 priority pollutants in paragraph (d)(1) of this section may be determined by engineering calculations which demonstrate that the regulated pollutants are not detectable in the final discharge by the analytical methods in 40 CFR 136.

(e) The quantity of pollutants discharged in chemical metal cleaning wastes shall not exceed the quantity determined by multiplying the flow of chemical metal cleaning wastes times the concentration listed in the following table:

Pollutant or Pollutant Property	Maximum for any one day (mg/l)	<u>BAT Effluent Limitations</u>
		Average of daily values for thirty consecutive days shall not exceed - (mg/l)
Copper, total	1.0	1.0
Iron, total	1.0	1.0

(f) [Reserved - Nonchemical Metal Cleaning Wastes].

(g) At the permitting authority's discretion, the quantity of pollutant allowed to be discharged may be expressed as a concentration limitation instead of the mass based limitations specified in paragraphs (b) through (e) of this section. Concentration limitations shall be those concentrations specified in this section.

(h) In the event that waste streams from various sources are combined for treatment or discharge, the quantity of each pollutant or pollutant property controlled in paragraphs (a) through (g) of this section attributable to each controlled waste source shall not exceed the specified limitation for that waste source.

§423.14 Effluent limitations guidelines representing the degree of effluent reduction attainable by the application of the best conventional pollutant control technology (BCT). [Reserved.]

§423.15 Standards of performance for new sources (NSPS).

Any new source subject to this subpart must achieve the following new source performance standards:

(a) The pH of all discharges, except once through cooling water, shall be within the range of 6.0-9.0.

(b) There shall be no discharge of polychlorinated biphenyl compounds such as those commonly used for transformer fluid.

(c) The quantity of pollutants discharged from low volume waste sources shall not exceed the quantity determined by multiplying the flow of low volume waste sources times the concentration listed in the following table:

---

Pollutant or Pollutant Property	<u>NSPS Effluent Limitations</u>	
	Maximum for any one day (mg/l)	Average of daily values for thirty consecutive days shall not exceed - (mg/l)
TSS	100.0	30.0
Oil and Grease	20.0	15.0

---

Pollutant or Pollutant Property	<u>NSPS Effluent Limitations</u>	
	Maximum Concentration (mg/l)	
Total residual chlorine	0.20	

(2) Total residual chlorine may not be discharged from any single generating unit for more than two hours per day unless the discharger demonstrates to the permitting authority that discharge for more than two hours is required for macroinvertebrate control. Simultaneous multi-unit chlorination is permitted.

(1)(1) For any plant with a total rated generating capacity of less than 25 megawatts, the quantity of pollutants discharged in once through cooling water shall not exceed the quantity determined by multiplying the flow of once through cooling water sources times the concentration listed in the following table:

Pollutant or Pollutant Property	<u>NSPS Effluent Limitations</u>	
	Maximum Concentration (mg/l)	Average Concentration (mg/l)
Free available chlorine	0.5	0.2

(2) Neither free available chlorine nor total residual chlorine may be discharged from any unit for more than two hours in any one day and not more than one unit in any plant may discharge free available or total residual chlorine at any one time unless the utility can demonstrate to the Regional Administrator or State, if the State has NPDES permit issuing authority, that the units in a particular location cannot operate at or below this level of chlorination.

(j)(1) The quantity of pollutants discharged in cooling tower blowdown shall not exceed the quantity determined by multiplying the flow of cooling tower blowdown times the concentration listed below:

(d) The quantity of pollutants discharged in chemical metal cleaning wastes shall not exceed the quantity determined by multiplying the flow of chemical metal cleaning wastes times the concentration listed in the following table:

Pollutant or Pollutant Property	NSPS Effluent Limitations	
	Maximum for any one day (mg/l)	Average of daily values for thirty consecutive days shall not exceed - (mg/l)
TSS	100.0	30.0
Oil and Grease	20.0	15.0
Copper, Total	1.0	1.0
Iron, Total	1.0	1.0

(e) [Reserved - Non chemical Metal Cleaning Wastes].

(f) The quantity of pollutants discharged in bottom ash transport water shall not exceed the quantity determined by multiplying the flow of the bottom ash transport water times the concentration listed in the following table:

Pollutant or Pollutant Property	NSPS Effluent Limitations	
	Maximum for any one day (mg/l)	Average of daily values for thirty consecutive days shall not exceed - (mg/l)
TSS	100.0	30.0
Oil and Grease	20.0	15.0

(g) There shall be no discharge of wastewater pollutants from fly ash transport water.

(h)(1) For any plant with a total rated electric generating capacity of 25 or more megawatts, the quantity of pollutants discharged in once through cooling water from each discharge point shall not exceed the quantity determined by multiplying the flow of once through cooling water from each discharge point times the concentration listed in the following table:

Pollutant or Pollutant Property	NSPS Effluent Limitations	
	Maximum Concentration (mg/l)	Average Concentration (mg/l)
Free available chlorine	0.5	0.2

Pollutant or Pollutant Property	Maximum for any one day (mg/l)	Average of daily values for thirty consecutive days shall not exceed - (mg/l)
The 126 priority pollutants (Appendix A) contained in chemicals added for cooling tower maintenance, except:	No detectable amount	
Chromium, total	0.2	0.2
Zinc, total	1.0	1.0

(2) Neither free available chlorine nor total residual chlorine may be discharged from any unit for more than two hours in any one day and not more than one unit in any plant may discharge free available or total residual chlorine at any one time unless the utility can demonstrate to the Regional Administrator or State, if the State has NPDES permit issuing authority, that the units in a particular location cannot operate at or below this level of chlorination.

(3) At the permitting authority's discretion, instead of the monitoring in 40 CFR 122.11(b), compliance with the limitations for the 126 priority pollutants in paragraph (j)(1) of this section may be determined by engineering calculations which demonstrate that the required pollutants are not detectable in the final discharge by the analytical methods in 40 CFR 136.

(k) Subject to the provisions of §423.15(1), the quantity or quality of pollutants or pollutant parameters discharged in coal pile runoff shall not exceed the limitations specified below:

Pollutant or Pollutant Property	NSPS Effluent Limitations
	for any time
TSS	Not to exceed 50 mg/l



(l) Any untreated overflow from facilities designed, constructed, and operated to treat the coal pile runoff which results from a 10 year, 24 hour rainfall event shall not be subject to the limitations in 423.15(k).

(m) At the permitting authority's discretion, the quantity of pollutant allowed to be discharged may be expressed as a concentration limitation instead of the mass based limitation specified in paragraphs (c) through (j) of this section. Concentration limits shall be based on the concentrations specified in this section.

(n) In the event that waste streams from various sources are combined for treatment or discharge, the quantity of each pollutant or pollutant property controlled in paragraphs (a) through (m) of this section attributable to each controlled waste source shall not exceed the specified limitation for that waste source.

§423.16 Pretreatment standards for existing sources (PSES).

Except as provided in 40 CFR Parts 403.7 and 403.13, any existing source subject to this subpart which introduces pollutants into a publicly owned treatment works must comply with 40 CFR 403 and achieve the following pretreatment standards for existing sources (PSES) by July 1, 1984:

(a) There shall be no discharge of polychlorinated biphenyl compounds such as those used for transformer fluid.

(b) The pollutants discharged in chemical metal cleaning wastes shall not exceed the concentration listed in the following table:

Pollutant or Pollutant Property	<u>PSES Pretreatment Standards</u>
	Maximum for one day
Copper, total	1.0 mg/l

(c) [Reserved - Non chemical Metal Cleaning Wastes].

(d)(1) The pollutants discharged in cooling tower blowdown shall not exceed the concentration listed in the following table:

Pollutant or Pollutant Property	<u>PSES Pretreatment Standards</u>
	Maximum for any time
The 126 priority pollutants (Appendix A) contained in chemicals added for cooling tower maintenance, except:	No detectable amount
Chromium, total	0.2 mg/l
Zinc, total	1.0 mg/l

(2) At the permitting authority's discretion, instead of the monitoring in 40 CFR 122.11(b), compliance with the limitations for the 126 priority pollutants in paragraph (d)(1) of this section may be determined by engineering calculations which demonstrate that the regulated pollutants are not detectable in the final discharge by the analytical methods in 40 CFR 136.

§423.17 Pretreatment standards for new sources (PSNS).

Except as provided in 40 CFR Part 403.7, any new source subject to this subpart part which introduces pollutants into a publicly owned treatment works must comply with 40 CFR Part 403 and the following pretreatment standards for new sources (PSNS).

(a) There shall be no discharge of polychlorinated biphenyl compounds such as those used for transformer fluid.

(b) The pollutants discharged in chemical metal cleaning wastes shall not exceed the concentration listed in the following table:

Pollutant or Pollutant Property	<u>PSNS Pretreatment Standards</u>
	Maximum for one day
Copper, total	1.0 mg/l

(c) [Reserved - Non chemical Metal Cleaning Wastes].

(d)(1) The pollutants discharged in cooling tower blowdown shall not exceed the concentration listed in the following table:

Pollutant or Pollutant Property	<u>PSNS Pretreatment Standards</u> Maximum for any time
The 126 priority pollutants (Appendix A) contained in chemicals added for cooling tower maintenance, except:	No detectable amount
Chromium, total	0.2 mg/l
Zinc, total	1.0 mg/l

(2) At the permitting authority's discretion, instead of the monitoring in 40 CFR 122.11(b), compliance with the limitations for the 126 priority pollutants in paragraph (d)(1) of this section may be determined by engineering calculations which demonstrate that the regulated pollutants are not detectable in the final discharge by the analytical methods in 40 CFR 136.

(e) There shall be no discharge of wastewater pollutants from fly ash transport water.

2. 40 CFR Part 125.30(a) is revised to amend the last sentence thereof to read as follows:

§123.30 [Amended].

(a) \*\*\* This subpart applies to all national limitations promulgated under Sections 301 and 304 of the Act, except for the BPT limits contained in 40 CFR Part 423.12 (steam electric generating point source category).

## 126 Priority Pollutants

- 001 Acenaphthene
- 002 Acrolein
- 003 Acrylonitrile
- 004 Benzene
- 005 Benzidine
- 006 Carbon tetrachloride  
(tetrachloromethane)
- 007 Chlorobenzene
- 008 1,2,4-trichlorobenzene
- 009 Hexachlorobenzene
- 010 1,2-dichloroethane
- 011 1,1,1-trichloroethane
- 012 Hexachloroethane
- 013 1,1-dichloroethane
- 014 1,1,2-trichloroethane
- 015 1,1,2,2-tetrachloroethane
- 016 Chloroethane
- 018 Bis (2-chloroethyl) ether
- 019 2-chloroethyl vinyl ether  
(mixed)
- 020 2-chloronaphthalene
- 021 2,4,6-trichlorophenol
- 022 Parachlorometa cresol
- 023 Chloroform (trichloro-

methane)

- 024 2-chlorophenol
- 025 1,2-dichlorobenzene
- 026 1,3-dichlorobenzene
- 027 1,4-dichlorobenzene
- 028 3,3-dichlorobenzidine
- 029 1,1-dichloroethylene
- 030 1,2-trans-dichloroethylene
- 031 2,4-dichlorophenol
- 032 1,2-dichloropropane
- 033 1,2-dichloropropylene  
(1,3-dichloropropene)
- 034 2,4-dimethylphenol
- 035 2,4-dinitrotoluene
- 036 2,6-dinitrotoluene
- 037 1,2-diphenylhydrazine
- 038 Ethylbenzene
- 039 Fluoranthene
- 040 4-chlorophenyl phenyl ether
- 041 4-bromophenyl phenyl ether
- 042 Bis(2-chloroisopropyl) ether
- 043 Bis(2-chloroethoxy) methane
- 044 Methylene chloride  
(dichloromethane)
- 045 Methyl chloride  
(dichloromethane)
- 046 Methyl bromide

- (bromomethane)
- 047 Bromoform (tribromo-  
methane)
  - 048 Dichlorobromomethane
  - 051 Chlorodibromomethane
  - 052 Hexachlorobutadiene
  - 053 Hexachloromyclopenta-  
diene
  - 054 Isophorone
  - 055 Naphthalene
  - 056 Nitrobenzene
  - 057 2-nitrophenol
  - 058 4-nitrophenol
  - 059 2,4-dinitrophenol
  - 060 4,6-dinitro-o-cresol
  - 061 N-nitrosodimethylamine
  - 062 N-nitrosodiphenylamine
  - 063 N-nitrosodi-n-propylamin
  - 064 Pentachlorophenol
  - 065 Phenol
  - 066 Bis(2-ethylhexyl)phthalate
  - 067 Butyl benzyl phthalate
  - 068 Di-N-Butyl Phthalate
  - 069 Di-n-octyl phthalate
  - 070 Diethyl Phthalate
  - 071 Dimethyl phthalate
  - 072 1,2-benzanthracene

- (benzo(a)anthracene)
- 073 Benzo(a)pyrene (3,4-benzo-  
pyrene)
- 074 3,4-Benzofluoranthene  
(benzo(b)fluoranthene)
- 075 1,12-benzofluoranthene  
(benzo(b)fluoranthene)
- 076 Chrysene
- 077 Acenaphthylene
- 078 Anthracene
- 079 1,12-benzoperylene  
(benzo(ghi)perylene)
- 080 Fluorene
- 081 Phenanthrene
- 082 1,2,5,6-dibenzanthracene  
(dibenzo(,h)anthracene)
- 083 Indeno(1,2,3-cd) pyrene  
(2,3-o-pheynylene pyrene)
- 084 Pyrene
- 085 Tetrachloroethylene
- 086 Toluene
- 087 Trichloroethylene
- 088 Vinyl chloride (chloroethylene)
- 089 Aldrin
- 090 Dieldrin
- 091 Chlordane (technical mixture  
and metabolites)

092 4,4-DDT  
093 4,4-DDE (p,p-DDX)  
094 4,4-DDD (p,p-TDE)  
095 Alpha-endosulfan  
096 Beta-endosulfan  
097 Endosulfan sulfate  
098 Endrin  
099 Endrin aldehyde  
100 Heptachlor  
101 Heptachlor epoxide  
(BHC-hexachlorocyclo-  
hexane)  
102 Alpha-BHC  
103 Beta-BHC  
104 Gamma-BHC (lindane)  
105 Delta-BHC (PCB-poly-  
chlorinated biphenyls)  
106 PCB-1242 (Arochlor 1242)  
107 PCB-1254 (Arochlor 1254)  
108 PCB-1221 (Arochlor 1221)  
109 PCB-1232 (Arochlor 1232)  
110 PCB-1248 (Arochlor 1248)  
111 PCB-1260 (Arochlor 1260)  
112 PCB-1016 (Arochlor 1016)  
113 Toxaphene  
114 Antimony  
115 Arsenic



- 116 Asbestos
- 117 Beryllium
- 118 Cadmium
- 119 Chromium
- 120 Copper
- 121 Cyanide, Total
- 122 Lead
- 123 Mercury
- 124 Nickel
- 125 Selenium
- 126 Silver
- 127 Thallium
- 126 Silver
- 128 Zinc
- 129 2,3,7,8-tetrachloro-  
dibenzo-p-dioxin (TCDD)



## SECTION III

### INTRODUCTION

#### BACKGROUND

The primary effluent guidelines document for the steam electric power industry (1) was published by the Environmental Protection Agency (EPA) in October 1974. This document still serves as the fundamental source of information for the industry as to its process descriptions, wastewater quantities and compositions, treatment and control technologies, and achievable pollutant levels for conventional and nonconventional pollutants. A supplemental document (2) published by EPA provided information on pretreatment for wastewater discharged by the steam electric industry to publicly owned treatment works (POTW).

Subsequent to the publishing of the 1974 document, three events which have implications for the effluent limitations guidelines for the steam electric power industry have occurred. First, the Settlement Agreement on June 7, 1976 between the Natural Resources Defense Council (NRDC) and EPA (3) requires that EPA develop and promulgate effluent limitations guidelines reflecting best available technology economically achievable (BATEA), standards of performance for new sources, and pretreatment standards for new and existing sources for 21 major industries, taking into account a list of 65 classes of toxic pollutants. This list has now been modified to 126 specific priority pollutants. The original list of 65 classes of pollutants appears in table III-1. The present list of 126 priority pollutants is presented in table III-2. Second, the U.S. Court of Appeals ruling of July 16, 1976 (4) remanded for reconsideration various parts of the October 1974 effluent limitations guidelines for the steam electric industry. Third, the Clean Water Act Amendments of 1977 require the review and, if appropriate, revision of each effluent standard at least every three years.

#### PURPOSE

This supplemental document provides a basis for the revision of effluent limitations guidelines for the steam electric power industry. It forms the technical basis for the revised steam electric power generating effluent limitations based on the BATEA, new source performance standards (NSPS) and pretreatment standards in conformance with the June 7, 1976 Consent Decree.

The steam electric power industry covered in this document is classified in Standard Industrial Classification (SIC) Codes 4911

Table III-1

LIST OF SIXTY-FIVE CLASSES OF POLLUTANTS CONTAINED IN  
SETTLEMENT AGREEMENT BETWEEN EPA AND NRDC (3)

Acenaphthene  
Acrolein  
Acrylonitrile  
Aldrin/Dieldrin  
Antimony and compounds\*  
Arsenic and compounds  
Asbestos  
Benzene  
Benzidine  
Beryllium and compounds  
Cadmium and compounds  
Carbon tetrachloride  
Chlordane (technical mixture and metabolites)  
Chlorinated benzenes (other than dichlorobenzenes)  
Chlorinated ethanes (included 1,2-dichloroethane,  
1,1,1-trichloroethane, and hexachloroethane)  
Chloroalkyl ethers (Chloromethyl, chlorethyl, and mixed ethers)  
Chlorinated naphthalene  
Chlorinated Phenols (other than those listed elsewhere, includes  
trichlorophenols and chlorinated cresols)  
Chloroform  
2-chlorophenol  
Chromium and compounds  
Copper and compounds  
Cyanides  
DDT and metabolites  
Dichlorobenzenes (1,2-, 1,3-, and 1,4-dichlorobenzenes)  
Dichlorobenzidene  
Dichloroethylenes (1,1- and 1,2-dichloroethylene)  
2,4-dichlorophenol  
Dichloropropane and dichloropropene  
2,4-dimethylphenol  
Dinitrotoluene  
Diphenylhydrazine  
Endosulfan and metabolites  
Endrin and metabolites  
Ethylbenzene  
Fluoranthene  
Haloethers (other than those listed elsewhere, includes  
chlorophenylphenyl ethers, bromophenylphenyl ether, bis  
(dichloroisopropyl) ether, bis-(chloroethoxy) methane and  
polychlorinated diphenyl ethers)

Table III-1 (Continued)

LIST OF SIXTY-FIVE CLASSES OF POLLUTANTS CONTAINED IN  
SETTLEMENT AGREEMENT BETWEEN EPA AND NRDC (3)

Halomethanes (other than those listed elsewhere, includes  
methylene chloride methylchloride, methylbromide, bromoform,  
dichlorobromomethane, trichlororfluoromethane,  
dichlorodifluoromethane)  
Heptachlor and metabolites  
Hexachlorobutadiene  
Hexachlorocyclohexane (all isomers)  
Hexachlorocyclopentadiene  
Isophorone  
Lead and compounds  
Mercury and compounds  
Naphthalene  
Nickel and compounds  
Nitrobenzene  
Nitrophenols (Including 2,4-dinitrophenol, dinitrocresol)  
Nitrosamines  
Pentachlorophenol  
Phenol  
Phthalate esters  
Polychlorinated biphenyls (PBCs)  
Polynuclear aromatic hydrocarbons (Including benzantracenes,  
benzopyrenes, benzofluoranthene, chrysene,  
dibenzanthracenes, and indenopyrenes)  
Selenium and compounds  
Silver and compounds  
2,3,7,8,-Tetrachlorodibenzo-p-dioxin (TCDD)  
Tetrachloroethylene  
Thallium and compounds  
Toluene  
Toxaphene  
Trichloroethylene  
Vinyl chloride  
Zinc and compounds

\*As used throughout this table the term "compounds" shall include  
organic and inorganic compounds.

Table III-2

## LIST OF 126 PRIORITY POLLUTANTS (2)

Compound Name

1. \*acenaphthene (B)\*\*\*
2. \*acrolein (V)\*\*\*
3. \*acrylonitrile (V)
4. \*benzene (V)
5. \*benzidene (B)
6. \*carbon tetrachloride (tetrachloromethane) (V)

\*Chlorinated benzenes (other than dichlorobenzenes)

7. chlorobenzene (V)
8. 1,2,4-trichlorobenzene (B)
9. hexachlorobenzene (B)

\*Chlorinated ethanes (including 1,2-dichloroethane, 1,1,1-trichloroethane and hexachloroethane)

10. 1,2-dichloroethane (V)
11. 1,1,1-trichloroethane (V)
12. hexachloroethane (B)
13. 1,1-dichloroethane (V)
14. 1,1,2-trichloroethane (V)
15. 1,1,2,2-tetrachloroethane (V)
16. chloroethane (V)

\*Chloroalkyl ethers (chloromethyl, chloroethyl and mixed ethers)

17. bis (2-chloroethyl) ether (B)
18. 2-chloroethyl vinyl ether (mixed) (V)

\*Chlorinated naphthalene

19. 2-chloronaphthalene (B)

\*Chlorinated phenols (other than those listed elsewhere; includes trichlorophenols and chlorinated cresols)

20. 2,4,6-trichlorophenol (A)\*\*\*
21. parachlorometa cresol (A)
22. \*chloroform (trichloromethane) (V)
23. \*2-chlorophenol (A)

Table III-2 (Continued)

LIST OF 126 PRIORITY POLLUTANTS (2)

\*Dichlorobenzenes

- 24. 1,2-dichlorobenzene (B)
- 25. 1,3-dichlorobenzene (B)
- 26. 1,4-dichlorobenzene (B)

\*Dichlorobenzidine

- 27. 3,3'-dichlorobenzidine (B)

\*Dichloroethylenes (1,1-dichloroethylene and 1,2-dichloroethylene)

- 28. 1,1-dichloroethylene (V)
- 29. 1,2-trans-dichloroethylene (V)
- 30. \*2,4-dichlorophenol (A)

\*Dichloropropane and dichloropropene

- 31. 1,2-dichloropropane (V)
- 32. 1,2-dichloropropylene (1,3-dichloropropene) (V)
- 33. \*2,4-dimethylphenol (A)

\*Dinitrotoluene

- 34. 2,4-dinitrotoluene (B)
- 35. 2,6-dinitrotoluene (B)
- 36. \*1,2-diphenylhydrazine (B)
- 37. \*ethylbenzene (V)
- 38. \*fluoranthene (B)

\*Haloethers (other than those listed elsewhere)

- 39. 4-chlorophenyl phenyl ether (B)
- 40. 4-bromophenyl phenyl ether (B)
- 41. bis(2-chloroisopropyl) ether (B)
- 42. bis(2-chloroethoxy) methane (B)

\*Halomethanes (other than those listed elsewhere)

- 43. methylene chloride (dichloromethane) (V)
- 44. methyl chloride (chloromethane) (V)
- 45. methyl bromide (bromomethane) (V)
- 46. bromoform (tribromomethane) (V)
- 47. dichlorobromomethane (V)

Table III-2 (Continued)

LIST OF 126 PRIORITY POLLUTANTS (2)

- 48. chlorodibromomethane (V)
- 49. \*hexachlorobutadiene (B)
- 50. \*hexachlorocyclopentadiene (B)
- 51. \*isophorone (B)
- 52. \*naphthalene (B)
- 53. \*nitrobenzene (B)

\*Nitrophenols (including 2,4-dinitrophenol and dinitrocesol)

- 54. 2-nitrophenol (A)
- 55. 4-nitrophenol (A)
- 56. \*2,4-dinitrophenol (A)
- 57. 4,6-dinitro-o-cresol (A)

\*Nitrosamines

- 58. N-nitrosodimethylamine (B)
- 59. N-nitrosodiphenylamine (B)
- 60. N-nitrosodi-n-propylamine (B)
- 61. \*pentachlorophenol (A)
- 62. \*phenol (A)

\*Phthalate esters

- 63. bis(2-3ethylhexyl) phthalate (B)
- 64. butyl benzyl phthalate (B)
- 65. di-n-butyl phtalate (B)
- 66. di-n-octyl phtalate (B)
- 67. diethyl phtalate (B)
- 68. dimethyl phthalate (B)

\*Polynuclear aromatic hydrocarbons

- 69. benzo (a)anthracene (1,2-benzanthracene) (B)
- 70. benzo (a)pyrene (3,4-benzopyrene) (B)
- 71. 3,4-benzofluoranthene (B)
- 72. benzo(k)fluoranthene (11,12-benzofluoranthene) (B)
- 73. chrysene (B)
- 74. acenaphthylene (B)
- 75. anthracene (B)
- 76. benzo(ghi)perylene (1,12-benzoperylene) (B)
- 77. fluroene (B)
- 78. phenathrene (B)



Table III-2 (Continued)

LIST OF 126 PRIORITY POLLUTANTS (2)

- 79. dibenzo (a,h)anthracene (1,2,5,6-dibenzanthracene) (B)
- 80. indeno (1,2,3-cd)(2,3,-o-phenylenepylene) (B)
- 81. pyrene (B)
- 82. \*tetrachloroethylene (V)
- 83. \*toluene (V)
- 84. \*trichloroethylene (V)
- 85. \*vinyl chloride (chloroethylene) (V)

Pesticides and Metabolites

- 86. \*aldrin (P)
- 87. \*dieldrin (P)
- 88. \*chlordane (technical mixture and metabolites) (P)

\*DDT and metabolites

- 89. 4,4'-DDT (P)
- 90. 4,4'-DDE(p,p'DDX) (P)
- 91. 4,4'-DDD(p,p'TDE) 9 (P)

\*endosulfan and metabolites

- 92. a-endosulfan-Alpha (P)
- 93. b-endosulfan-Beta (P)
- 94. endosulfan sulfate (P)

\*endrin and metabolites

- 95. endrin (P)
- 96. endrin aldehyde (P)

\*heptachlor and metabolites

- 97. heptachlor (P)
- 98. heptachlor epoxide (P)

\*hexachlorocyclohexane (all isomers)

- 99. a-BHC-Alpha (P) (B)
- 100. b-BHC-Beta (P) (V)
- 101. r-BHC (lindane)-Gamma (P)
- 102. g-BHC-Delta (P)

Table III-2 (Continued)

LIST OF 126 PRIORITY POLLUTANTS (2)

\*polychlorinated biphenyls (PCB's)

103.	PCB-1242 (Arochlor 1242)	(P)
104.	PCB-1254 (Arochlor 1254)	(P)
105.	PCB-1221 (Arochlor 1221)	(P)
106.	PCB-1232 (Arochlor 1232)	(P)
107.	PCB-1248 (Arochlor 1248)	(P)
108.	PCB-1260 (Arochlor 1260)	(P)
109.	PCB-1016 (Arochlor 1016)	(P)
110.	*Toxaphene	(P)
111.	*Antimony (Total)	(P)
112.	*Arsenic (Total)	
113.	*Asbestos (Fibrous)	
114.	*Beryllium (Total)	
115.	*Cadmium (Total)	
116.	*Chromium (Total)	
117.	*Copper (Total)	
118.	*Cyanide (Total)	
119.	*Lead (Total)	
120.	*Mercury (Total)	
121.	*Nickel (Total)	
122.	*Selenium (Total)	
123.	*Silver (Total)	
124.	*Thallium (Total)	
125.	*Zinc (Total)	
126.	**2,3,7,8-tetrachlorodibenzo-p-dioxin (TCDD)	

---

\*Specific compounds and chemical classes as listed in the consent degree.

\*\*This compound was specifically listed in the consent degree.

Because of the extreme toxicity (TCDD), EPA recommends that laboratories not acquire analytical standard for the compound.

\*\*\*B = analyzed in the base-neutral extraction fraction

V = analyzed in the volatile organic fraction

A = analyzed in the acid extraction fraction

P = pesticide

and 4931 (5). Code 4911 encompasses establishments engaged in the generation, transmission, and/or distribution of electric energy for sale. Code 4931 encompasses establishments primarily engaged in providing electric service in combination with other services, with electric services as the major part though less than 95 percent of the total. The SIC Manual (5) recommends that, when available, the value of receipts or revenues be used in assigning industry codes for transportation, communication, electric, gas, and sanitary services. This study was limited to powerplants comprising the steam electric utility industry and did not include steam electric powerplants in industrial, commercial or other facilities. Electric generating facilities other than steam electric, such as combustion gas turbines, diesel engines, etc., are included to the extent that power generated by the establishment in question is produced primarily through steam electric processes. This report covers effluents from both fossil-fueled and nuclear plants, but excludes the radiological aspects of effluents.

The Clean Water Act (6) requires EPA to consider several factors in developing effluent limitation guidelines and standards of performance for a given industry. These include the total cost of applying a technology in relation to the effluent reduction benefits realized; the age of equipment and facilities; the processes employed; the engineering aspects of applying various types of control techniques; process changes; nonwater quality environmental impacts (including energy requirements); and other factors. For steam electric powerplants, a formal subdivision of the industry on the basis of the factors mentioned in the Act was inapplicable. The two basic aspects of the effluents produced by the industry--chemical and thermal--involve such divergent considerations that a basic distinction between guidelines for chemical wastes and thermal discharges was determined to be most useful in achieving the objectives of the Act. Accordingly, this report covers waste categorization, control and treatment technology, and recommendations for effluent limitations for chemical and other non-thermal aspects of waste discharge in accordance with the NRDC settlement agreement.

#### INFORMATION AVAILABILITY, SOURCES AND COLLECTION

Since the publication of the Burns & Roe document in 1974, EPA has collected additional information on the industry profile, its waste characteristics, and applicable treatment technologies. In addition, the NRDC settlement agreement focused attention on the need for information concerning the presence and toxicity of specific priority pollutants in the wastewaters. As a result of this attention, there have been various studies on the priority pollutants both as to their environmental effects and as to their occurrence in wastewater from the steam electric power industry.

The data base for effluent limitations and standards for the steam electric industry was revised on the basis of the following information sources:

1. A profile of the Steam Electric Power Generating point source category which lists the name of each plant; its location, age, and size; its wastewater characteristics; and its pollutant control technologies.
2. Available data from published and unpublished literature; demonstration project reports; the steam electric industry; manufacturers and suppliers of equipment and chemicals used by the industry; telephone conversations; various EPA, Federal, state, and local agencies; and responses to EPA's 308 letter (1976).
3. A statistical analysis of available data.
4. Engineering plant visits.
5. The sampling and analysis of selected plant waste streams for priority pollutants.

The current effluent guidelines are divided into four subcategories: generating units, small units, old units, and area runoff. Economic considerations, rather than chemical discharge characteristics, were the determining criteria for differentiating the first three subcategories. Available information indicates that the types of pollutants discharged by powerplants do not differ significantly among plants of varying age and size; the chemical waste characteristics are similar for similar waste sources. Limitations within each subcategory were therefore specified for each of the in-plant waste sources. These included: (1) cooling water; (2) ash-bearing streams; (3) metal cleaning waste; (4) low volume waste; (5) area runoff; and (6) wet flue gas cleaning blowdown.

#### Section 308 Data Forms

In order to carry out the Settlement Agreement with NRDC, EPA collected additional information on the production processes, raw waste loads, treatment methods, and effluent quality associated with the steam electric industry. This information was obtained via a data collection effort pursuant to Section 308 of the Clean Water Act (6). A sample 308 data collection questionnaire is provided in Appendix A. Section 308 letters and data collection questionnaires were sent to approximately 900 powerplants in the United States of which a total of 794 responded. The data in the responses were coded and subsequently keypunched onto data cards and loaded into a computerized data base. The data base was instrumental in supporting selection of plants for the sampling

visits, as well as a valuable tool in establishing how many plants employ what technologies relevant to pollution generation or control.

### Data Gathering and Analysis

Initial historical data gathering consisted of visiting the 10 EPA regional offices and several state environmental departments, contacting other EPA offices and governmental agencies, and conducting an extensive literature search. The initial phase of the data gathering effort occurred during the latter part of 1976 and early part of 1977. This was followed by the tabulation of each set of data corresponding to an outfall of a particular plant in terms of pollutant parameters monitored against the date of analysis. This information consisted of the list of the various streams being discharged through this particular outfall and the control or treatment technology to which these streams are subjected.

### Screen Sampling Program

A screen sampling program was developed to determine the presence of the 126 priority pollutants in steam electric power industry effluents. EPA selected eight plants for the screen sampling. These plants had indicated in their 308 responses that their discharge was known to contain one or more of the 129 priority pollutants. Selection was also based upon various plant variables which could affect plant discharge and effluent composition. The eight plants selected for the screen sampling program were Plants 4222, 2414, 0631, 1720, 3404, 2512, 3805, and 4836.

The screen sampling procedures followed the Environmental Protection Agency Screen Sampling Procedure for the Measurement of Priority Pollutants (7). Grab and continuous composite samples were collected over 24-hour sampling periods. The continuous 24-hour samples were collected by automatic samplers and maintained at 4°C, while the grab samples were maintained at ambient temperature levels which did not exceed 4°C. At the end of the 24-hour sampling period, samples were preserved according to protocol.

Representatives of both EPA and the electric power industry were present during all sampling. Parallel sampling (two separate samples) and analysis were conducted. Samples of all waste streams were analyzed by both EPA-contracted laboratories and power industry-contracted laboratories.

The EPA-contracted analytical laboratory used analytical procedures derived from Standard Methods for the Examination of Water

and Wastewater (14th Edition). Organics were analyzed by first extracting the sample into base, neutral, acid, and volatile fractions and then analyzing each fraction by gas chromatography with a mass spectrometer detector (GC/MS). Cyanide was analyzed by steam distillation followed by the standard colorimetric method. Samples were analyzed for heavy metals by atomic adsorption spectrophotometry and inductively-coupled argon plasma emission spectrometry.

Although the screen sampling program was intended only to determine the presence or absence of the 129 priority pollutants, the methods of analysis did yield numerical concentrations for detected compounds. Thus, the screening data provided quantified values for detected priority pollutants.

#### Verification Sampling Program

A verification program followed screen sampling in order to quantify further the pollutant loadings from the power generating industry. This sampling program was used to verify the results of the screen sampling program for both organic and inorganic analyses. Verification involved more plants and was a more intensive effort compared to the screening study. The sixteen plants selected for the verification sampling program were Plants 2718, 1716, 3414, 4826, 1742, 1245, 1226, 4251, 3404, 4602, 3920, 3924, 3001, 1741, 5410, and 2121.

Representatives of both EPA and the electric power industry were present during all the verification sampling. Splits of a single collected sample were used; one half of the original sample went to the EPA-contracted analytical laboratory and the other half went to the power industry-contracted laboratory.

Two additional plants were added to the verification data base as data became available from another contractor using the methods and format of the sixteen earlier verification studies. These are Plants 5409 and 5604.

Sampling and preservation procedures were similar to those of the screen sampling program, except that identical, not parallel, samples were collected for shipment to the EPA and power industry analytical laboratories.

In total, samples from eighteen plants were analyzed with several different EPA-contracted laboratories analyzing some portion of these samples. Analytical procedures included gas chromatography (GC) and gas chromatography-mass spectrometry (GC/MS) for the organics, and spark source mass spectrometry (SSMS) and atomic absorption (AA) for most of the inorganics. Mercury was analyzed by cold-vapor atomic adsorption in one lab. Selenium was analyzed by fluorometry and cyanide by a colorimetric procedure.

## Surveillance and Analysis Sampling Program

Additional data were provided through several EPA regional Surveillance and Analysis (S&A) programs conducted by those regions. S&A programs involve periodic visits to powerplants by EPA sampling teams to collect data to determine if the plants are complying with NPDES permits. During some of these visits arrangements were made for the sampling of priority pollutants. Eight plants are represented in this data base; they are Plants 1002, 1003, 4203, 2608, 2603, 2607, 2750, and 5513.

The sampling, preservation, and analytical procedures for obtaining S&A data were similar to those employed in both the screening study and the verification study. Analytical methods included gas chromatography and atomic absorption.

## Waste Characterization Data Base

After evaluation of all the data from the three sampling efforts--screening, verification, and S&A sampling--the Agency decided that all three sets of data were useful in establishing the presence and quantifying the concentration of priority pollutants in discharges from steam electric power plants. All three sets of data were stored in computerized files such that they could be analyzed as a single data base representing the sampling of 34 plants.

## Engineering Visits to Steam Electric Plants

Eight steam electric plants were visited from March to April 1977 to obtain information on specific plant practices and to develop a sampling and analysis program to verify collected data, to fill existing gaps, and to provide additional information. Specific information gathered included data on raw waste loads, water use, treatment technology, fuel handling systems, and general plant descriptions. Additional engineering visits were conducted from August through September 1979. These visits were to collect data and water samples from plants with recycling bottom ash sluice systems. Fly ash handling methods also were evaluated during these visits.

## INDUSTRY DESCRIPTION

Steam electric powerplants produce electric power. The industry also transmits and distributes electric energy. The industry is made up of two basic ownership categories--investor owned and publicly owned, with the latter further divided into Federal agencies, non-Federal agencies, and cooperatives. About two-thirds of the 3,400 systems in the United States perform only the distribution function, but many perform all three functions:

production (generally referred to as generation), transmission, and distribution. In general, the larger systems are vertically integrated, while the smaller systems, largely in the municipal and cooperative categories, rely on purchases to meet all or part of their requirements. Many of the systems are interconnected and can, under emergency conditions, obtain power from other systems.

The industry started around 1880 with the construction of Edison's steam electric plant in New York City. For the next 60 years, growth was continuous but unspectacular due to the fairly limited demand for power; since 1940, however, the annual per capita production of electric energy has grown at a rate of about 6 percent per year and the total energy consumption by about 7 percent (1). As of spring 1977, there were over 1,000 generating systems in the United States. These systems had a combined generating capacity of 408,611 megawatts (MW) and produced 1,968,700,000 megawatt hours (MWh) of energy (8). Table III-3 shows the number of plants, capacity, and annual generation of the total electric utility industry as well as the steam electric sector. Non steam electric generation sources include principally hydroelectric, diesel, and combustion gas turbines.

Further industry information obtained from the 308 data questionnaire survey including data on plant size, fuel type, cooling type, and age. Four plant size ranges--0-25 megawatts, 26-100 megawatts, 101-500 megawatts, and over 500 megawatts--were used to represent very small, small, medium, and large plants. This conforms to the categorization used in the Federal Energy Administration (FEA) powerplant data base (9). Table III-4 shows the number of plants and their capacity for each of the four plant size categories. Because the 308 questionnaire was a sample survey, the information obtained by EPA on the number of plants in various size, age, and cooling type categories was used to estimate percent distributions which in turn were used to estimate number of plants in each size range of the FEA data base.

The addition of new plants will alter the 1977 plant and capacity distribution. By 1983, EPA projects that there will be 350 new steam electric plants with 180,000 megawatts of capacity. In the period 1984-1990, an additional 412 steam electric plants are anticipated with a capacity of 223,100 megawatts. These projections were derived from Temple, Barker and Sloane, Inc. (TBS) projections of future capacity requirements (8). Table III-5 shows the present and future capacity of the industry.

The Federal Energy Administration provided information on the number and capacity of existing steam electric powerplants by size category versus four categories of fuel: coal, oil/gas,



Table III-3

DISTRIBUTION OF THE STEAM SECTION RELATIVE TO THE  
ENTIRE ELECTRIC UTILITY INDUSTRY AS OF 1978\* (8, 9)

	<u>Capacity</u> (gigawatts)	<u>Generation</u> (billion kilowatt hours)	<u>Number</u> <u>of Plants</u>
Total Industry	573.8	2,295	>2,600
Steam Sector	453.3	1,951	842
Percent of Total Industry Included in Steam Sector	79%	85%	<32%

---

\*The number and capacity of plants in each category is based on the 1979 DOE Inventory of Powerplants data base. Plants listed in the DOE Inventory as having a net dependable capacity of zero were excluded.

Table III-4

YEAR-END 1978 DISTRIBUTION OF STEAM ELECTRIC PLANTS  
BY SIZE CATEGORY\* (8, 9)

	<u>0-25 MW</u>	<u>26-100 MW</u>	<u>101-200 MW</u>	<u>201-350 MW</u>	<u>351-500 MW</u>	<u>Over 500 MW</u>	<u>Total</u>
Total MW in Category	1,273	9,466	16,777	24,125	33,282	368,342	453,265
Percent of Total MW in Category	0.3%	2.1%	4.0%	5.3%	7.0%	81.3%	100.0%
Number of Plants in Category	98	172	115	87	79	291	842
Percent of Total Plants in Category	11.6%	20.4%	13.7%	10.3%	9.4%	34.6%	100.0%

---

\*The number and capacity of plants in each category is based on the 1979 DOE Inventory of Powerplants data base. Plants listed in the DOE Inventory as having a net dependable capacity of zero were excluded.

Table III-5

PRESENT AND FUTURE CAPACITY OF THE ELECTRIC UTILITY  
INDUSTRY (8, 9)

(capacity in gigawatts at year end)

	<u>1978</u>	<u>1985</u>	<u>1990</u>	<u>1995</u>
Generating Capacity				
Total Industry	573.8	750.3	834.9	1003.8
Steam Sector	453.3	614.4	695.7	855.4

---

Source. DOE Inventory of Powerplants (1979) and projections  
made by Temple, Barker and Sloane, Inc.

coal/oil/gas, and nuclear (1). The fuel mix of future plants was determined from the fuel types of the announced plant additions, adjusted to account for some expected fuel shifts, especially from gas to coal or oil (8). This information is presented in tables III-6 and III-7. A summary of existing and projected total capacity versus fuel type is presented in table III-8.

Steam electric powerplants discharge waste heat with once-through cooling systems, recirculating cooling systems, or a combination of both. The type of cooling system is important in determining the values of a plant's effluent discharge and therefore the cost of treating the discharge. Plants with once-through cooling water systems discharge the cooling water after only one pass through the plant. The waste heat is dissipated to a receiving body of water. Plants with recirculating cooling water systems use cooling towers, either forced draft or natural draft, and recirculate the water through the plant. A blowdown stream is typically discharged from a recirculating system to control the buildup of dissolved solids. The cooling mechanism, evaporation, results in the discharge of waste heat to the atmosphere and evaporation of water concentrates dissolved solids. Of the existing plants approximately 65 percent or 694 plants use once through cooling and 35 percent or 374 plants use recirculating cooling water systems.

The distribution of plants by age and size category, based on 308 data, appears in table III-9. Of the 1,068 steam electric plants existing in this country, 22 percent have been built since 1971. However, 57 percent of the steam plants built since 1971 lie in the 500 megawatts or larger size range. Plants built since 1971 represent about 40 percent of existing steam electric capacity. Forty-one (41) percent of the existing steam electric plants were built before 1960 and are nearly 20 years old. These plants represent about 18 percent of the plant capacity (8).

#### PROCESS DESCRIPTION

The "production" of electrical energy always involves the conversion of some other form of energy. The three most important sources of energy which are converted to electric energy are the gravitational potential energy of water, the atomic energy of nuclear fuels, and the chemical energy of fossil fuels. The use of water power involves the transformation of one form of mechanical energy into another prior to conversion to electrical energy and can be accomplished at greater than 90 percent of theoretical efficiency. Therefore, hydroelectric power generation produces only a minimal amount of waste heat through conversion inefficiencies. Current uses of fossil fuels, on the other hand, are based on a combustion process, followed by steam generation to convert the heat first into mechanical energy and

Table III-6

NUMBER OF EXISTING STEAM-ELECTRIC POWERPLANTS  
BY FUEL TYPE AND SIZE (8, 9)

(number of plants)

<u>Fuel Type</u>	<u>Plant Size Categories</u>						<u>Total</u>
	<u>0-25 MW</u>	<u>26-100 MW</u>	<u>101-200 MW</u>	<u>201-350 MW</u>	<u>351-500 MW</u>	<u>More Than 500 MW</u>	
<u>Existing (1979)</u>							
Coal	35	63	36	38	35	145	352
Oil/Gas	48	102	76	48	44	111	429
Nuclear	0	2	2	0	0	34	38
Other	15	5	1	1	0	1	23
Total	98	172	115	87	79	291	842

Source DOE Inventory of Powerplants (1979).

Table III-7

CAPACITY OF EXISTING AND NEW STEAM-ELECTRIC POWERPLANTS BY FUEL TYPE AND SIZE (8, 9)  
1978-1995  
(gigawatts)

Fuel Type	Plant Size Categories						Total
	0-25 MW	26- 100 MW	101- 200 MW	201- 350 MW	351- 500 MW	More Than 500 MW	
<u>Existing (1979)</u>							
Coal	.46	3.46	5.59	10.47	14.77	192.61	227.37
Oil/Gas	.67	5.69	10.71	13.33	18.52	121.16	170.07
Nuclear	0	.16	.35	0	0	53.31	53.83
Other	.14	.16	.13	.32	0	1.25	2.10
Total	<u>1.27</u>	<u>9.47</u>	<u>16.78</u>	<u>24.12</u>	<u>33.29</u>	<u>368.33</u>	<u>453.37</u>
<u>Additions (1978-1985)</u>							
Coal							79.20
Oil/Gas							19.80
Nuclear							85.40
Total							<u>184.40</u>
<u>Additions (1986-1995)</u>							
Coal							187.30
Oil/Gas							.20
Nuclear							142.10
Total							<u>329.60</u>
Total Additions (1978-1995)							514.00

Source. DOE Inventory of Powerplants.

Table III-8

EXISTING AND PROJECTED DISTRIBUTION OF STEAM ELECTRIC  
POWERPLANTS BY FUEL TYPE (8, 9)

(capacity in gigawatts)

	<u>1978</u> <sup>a</sup>	<u>1985</u> <sup>b</sup>	<u>1990</u> <sup>b</sup>	<u>1995</u> <sup>b</sup>
Coal Capacity	227.4	301.8	365.1	473.9
Number of Plants	352	467	565	734
Oil/Gas Capacity	170.1	173.5	157.4	100.4
Number of Plants	429	438	397	253
Nuclear Capacity	53.8	139.0	173.1	281.0
Number of Plants	38	98	122	198

---

Sources.<sup>a</sup>DOE, Inventory of Powerplants, (1979).<sup>b</sup>Electrical World, September 15, 1979, and projections by Temple, Barker, and Sloane, Inc.

Table III-9

## DISTRIBUTION OF STEAM-ELECTRIC CAPACITY BY PLANT SIZE AND IN-SERVICE YEAR (9)

Plant Age Category	Plant Size Category						Total	Percent of Total Capacity
	0-25	26-100	101-200	201-350	351-500	>500		
Pre-1960 MW	1,154	6,656	12,926	17,362	16,749	64,968	119,815	
Percent of Age Category	1	5.6	10.8	14.5	14	54	100	26
1961-1970 MW	344	2,157	4,052	6,570	9,630	112,844	135,597	
Percent of Age Category	.3	1.6	3.0	4.8	7.1	83	100	30
Post-1970 MW	20	1,135	1,543	3,942	7,539	184,502	198,681	
Percent of Age Category	.01	.6	.8	2	3.8	93	100	44
Total MW	1,518	9,948	18,521	27,874	33,918	362,314	454,093	
Percent of Age Category	.3	2	4	6	7	80	100	100

Source DOE Inventory of Powerplants, 1979.



then to convert the mechanical energy into electrical energy. Nuclear processes in general also depend on the conversion of thermal energy (heat) to mechanical energy via a steam cycle (1).

### Hydroelectric Power

Hydroelectric power uses the energy of falling water to produce electric power. Although the facility construction and development costs are high, the fuel itself is not an operational cost. Unfortunately, the availability of hydroelectric power is limited to locations where nature has created the opportunity of providing both water and elevation differences to make the energy extractable. The total hydroelectric capacity installed at the end of 1975 amounted to about 5 percent of the total installed United States generating capacity. This share of power is projected to decline to less than 0.1 percent by 1983 (8), primarily because the number of sites available for development have already been developed and the remaining sites are either too costly or too far from urban centers (10).

Another form of hydroelectric power is produced by means of pumped storage projects. The process involves pumping water into an elevated reservoir during off-peak load hours, and then generating electricity at peak load periods by conventional hydroelectric means. Although not as efficient as once-through hydroelectric power facilities, pumped storage projects are favorable for the peak load periods when power demands are very high and additional power generation capacity is needed to supplement the normal load generators.

In general, hydroelectric power represents a viable alternative to fossil-fueled or nuclear steam cycle generation where geographic, environmental, and economic conditions are favorable (1).

### Steam Electric Powerplants

Steam electric powerplants are the production facilities of the electric power industry. The process to produce electricity can be divided into four stages. In the first operation, fossil fuel (coal, oil, or natural gas) is burned in a boiler furnace. The evolving heat is used to produce pressurized and superheated steam. This steam is conveyed to the second stage--the turbine--where it gives energy to rotating blades and, in the process, loses pressure and increases in volume. The rotating blades of the turbine act to drive an electric generator or alternator to convert the imparted mechanical energy into electrical energy. The steam leaving the turbine enters the third stage--the condenser--where it is condensed to water. The liberated heat is

transferred to a cooling medium which is normally water. Finally, the condensed steam is reintroduced into the boiler by a pump to complete the cycle.

Historically, powerplants were categorized in accordance with the type of fuel they burned. Recently, however, because of the energy crisis and other cost factors, powerplants have modified their equipment to enable them to use more than one fuel. Based on 308 data, 78 percent of the steam electric power plants have the capability of using two or more fossil fuels, which indicates that the majority of all steam electric plants have the capability to burn more than one type of fossil fuel.

Figure III-1 shows a simplified flow diagram of a typical coal-fired powerplant. The figure depicts features which are common to all powerplants as well as features which are unique to coal-fired facilities. Features unique to coal-fired plants include coal storage and preparation (transport, beneficiation, pulverization, drying), coal-fired boiler, ash handling and disposal system, and flue gas cleaning and desulfurization. A brief description of these features and their environmental results is presented in subsequent sections of this document. EPA anticipates that future designs will emphasize recovery and reuse of resources, in particular recycle of water and use of fly ash as a resource.

#### Combustion Gas Turbines and Diesel Engines

Combustion gas turbines and diesel engines are devices for converting the chemical energy of fuels into mechanical energy by using the Brayton and Diesel thermal cycles as opposed to the Rankine cycle used with steam. In a combustion gas turbine, fuel is injected into compressed air in a combustion chamber. The fuel ignites, generating heat and combustion gases, and the gas mixture expands to drive a turbine, which is usually located on the same axle as the compressor. Various heat recovery and staged compression and combustion schemes are in use to increase overall efficiency. Aircraft jet engines have been used to drive turbines which, in turn, are connected to electric generators. In such units, the entire jet engine may be removed for maintenance and a spare installed with a minimum of outage time. Combustion gas turbines require little or no cooling water and therefore produce no significant effluent. Diesel engines, which can be operated at partial or full loads, are capable of being started in a very short time, so they are ideally suited for peaking use. Many large steam electric plants contain diesel generators for emergency shutdown and startup power (1). In 1975, gas turbine and diesel-powered electric generation plants represented 6.8 percent of the total United States generating capacity. By 1983 the number of gas turbine and diesel-powered

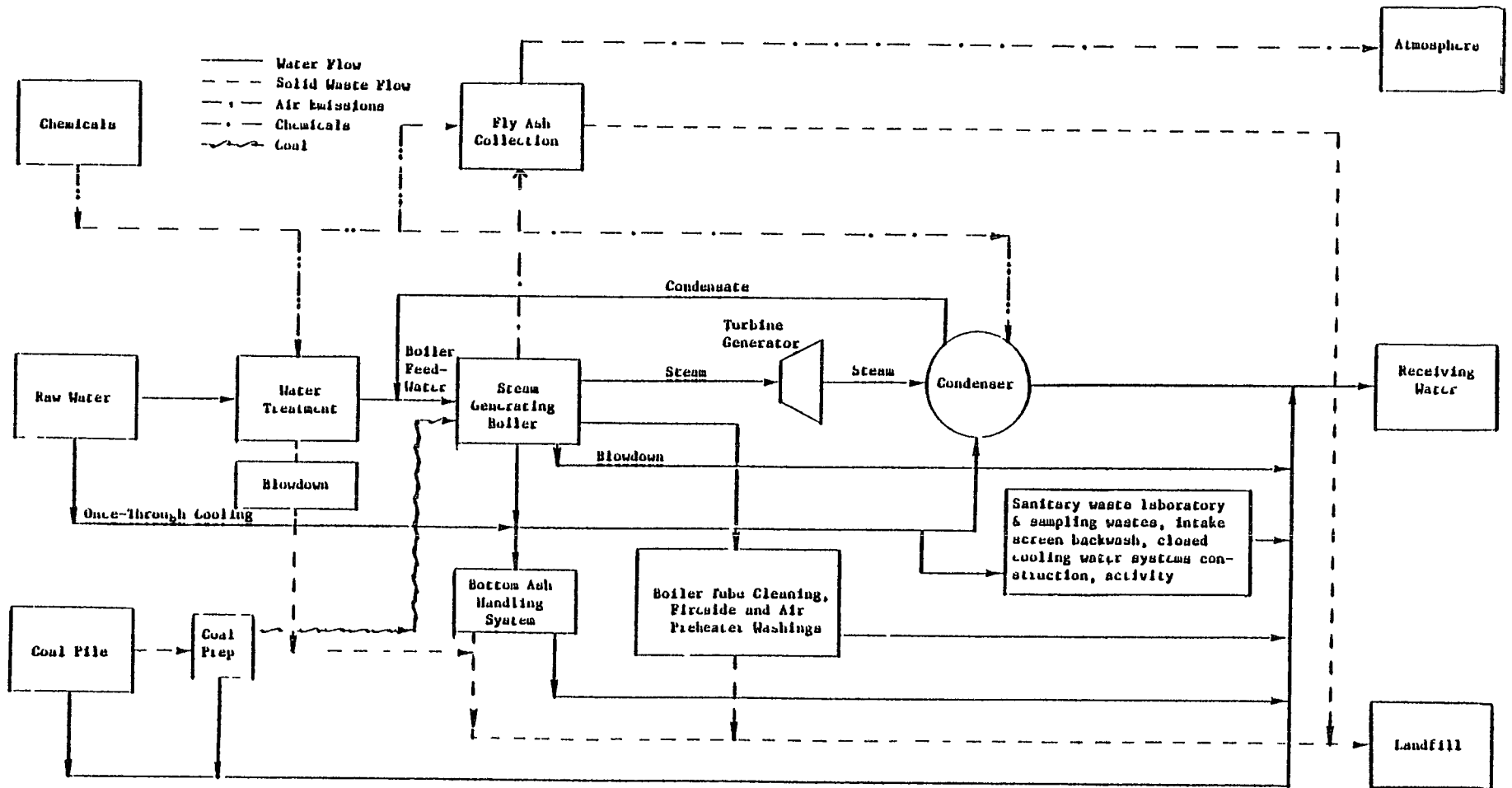

Figure III-1

TYPICAL COAL-FIRED STEAM ELECTRIC PLANT

electric generation plants is projected to decline to less than 0.1 percent of the total United States electric generating capacity (2).

### Nuclear Powerplants

Nuclear powerplants utilize a cycle similar to that used in fossil-fueled powerplants except that the source of heat is atomic interactions rather than combustion of fossil fuel. Water services as both moderator and coolant as it passes through the nuclear reactor core. In a pressurized water reactor, the heated water then passes through a separate heat exchanger where steam is produced on the secondary side. This steam, which contains no radioactive materials, drives the turbines. In a boiling water reactor, steam is generated directly in the reactor core and is then piped directly to the turbine. This arrangement produces some radioactivity in the steam and therefore requires some shielding of the turbine and condenser. Long term fuel performance and thermal efficiencies are similar for the two types of nuclear systems (1).

### ALTERNATE PROCESSES UNDER ACTIVE DEVELOPMENT

#### Future Nuclear Types

At the present time almost all of the nuclear powerplants in operation in the United States are of the boiling water reactor (BWR) or pressurized water reactor (PWR) type. Some technical aspects of these types of reactors limit their thermal efficiency to about 30 percent. There are potential problems in the area of fuel availability if the entire future nuclear capacity is to be met with these types of reactors. In order to overcome these problems, a number of other types of nuclear reactors are in various stages of development. The objective of developing these reactors is two fold: to improve overall efficiency by being able to produce steam under temperature and pressure conditions similar to those being achieved in fossil fuel plants and to assure an adequate supply of nuclear fuel at a minimum cost. Included in this group are the high temperature, gas-cooled reactor (HTGR), the seed blanket light water breeder reactor (LWBR), the liquid-metal fast breeder reactor (LMFBR), and the gas-cooled fast breeder reactor (GCFBR). All of these utilize a steam cycle as the last stage before generation of electric energy. Both the HTGR and the LMFBR have advanced sufficiently to be considered as potentially viable alternate processes.

The HTGR is a graphite-moderated reactor which uses helium as a primary coolant. The helium is heated to about 750 degrees Centigrade (1,400 degrees Fahrenheit) and then gives up its heat to a steam cycle which operates at a maximum temperature of about

550 degrees Centigrade (1,000 degrees Fahrenheit). As a result, the HTGR can be expected to produce electric energy at an overall thermal efficiency of about 40 percent. The thermal effects of its discharges should be similar to those of an equivalent capacity fossil-fueled plant. Its chemical wastes will be provided with essentially similar treatment systems which are presently being provided for BWR and PWR plants.

The LMFBR will have a primary and secondary loop cooled with sodium and a tertiary power producing loop utilizing a conventional steam system. Present estimates are that the LMFBR will operate at an overall thermal efficiency of about 36 percent, although higher efficiencies are deemed to be ultimately possible. The circulating water thermal discharges of the LMFBR will initially be about halfway between those of the best fossil-fueled plants and the current generation of nuclear plants. Chemical wastes will be similar to those of current nuclear plants (1).

### Coal Gasification

Coal gasification involves the production of fuel gas by the reaction of the carbon in the coal with steam and oxygen. The processes of this energy technology are divided into two groups depending upon the heating value of the product gas. Low Btu gasification utilizes air as the oxygen source and produces a CO and H<sub>2</sub>-rich gas with a heating value of 150-450 Btu/scf. High Btu gasification utilizes pure oxygen in the gasification process and produces a fuel gas of pipeline quality with a heating value of approximately 1,000 Btu/scf. The main difference between high and low Btu processing is the inclusion of shift conversion and methanation processes in the processing sequence for high Btu gasification.

The Federal Government and a number of private organizations are supporting research and development of coal gasification complexes. Estimates indicate that low Btu gasification of coal can be accomplished for less than twice the current natural gas price paid by electric utilities. As natural gas and fuel oil become increasingly short in supply, gasification of coal could well turn into a factor in steam electric power generation.

### Combined Cycle Powerplants

Combined cycle power systems combine gas turbine and steam turbine cycles to increase thermal efficiencies of power generation. The hot exhaust gases from a gas turbine are used to generate steam in an unfired boiler. The steam generated is used to drive a conventional steam turbine. Combined cycle systems might consist of a number of gas turbines exhausted into a single steam turbine with its own electric generating capacity.

Another combined cycle concept is a pressurized fluidized bed system. The concept is to burn coal in a fluidized bed environment of dolomite at 10 atmospheres of pressure. Steam is produced in the conventional manner of using boiler heat for the steam cycle but cleaned combustion gases are also used to produce electricity by use of a gas turbine. Waste heat is used to economize the cycle through preheating of boiler feed water.

## FUTURE GENERATING SYSTEMS

### Natural Energy Sources

**Geothermal Energy.** Geothermal energy is the natural heat contained in the crust of the earth. While ubiquitous throughout the earth's crust, only in a few geological formations is it sufficiently concentrated and near enough to the surface to make its recovery economically viable. Geothermal energy involves six major resource types of which two are currently capable of being utilized for the generation of electricity. Vapor-dominated reservoirs, such as those utilized at The Geysers, California, obtain steam directly from wells drilled into the geothermal reservoirs. The steam is then used to drive a steam turbine. Liquid-dominated reservoirs contain geothermal fluids consisting of hot water and steam. The geothermal fluids must first be flashed to steam or used to evaporate some other types of working fluid, which is then used to drive a steam turbine.

The advantage of geothermal power generation is that the energy source is essentially free after the initial exploration, drilling, and facility costs are paid off. The disadvantages of geothermal power generation are that the costs of facility siting and construction are high, and geothermal fluids must be cleaned prior to use and disposed of by reinjection to the subsurface geothermal reservoir.

**Solar Energy.** The conversion of solar energy to electricity at a large scale via a steam cycle involves the use of a large array of reflective focusing collectors which concentrate the solar radiation on a heat collector which heats water to steam. The steam is used to drive a steam turbine to produce electricity. The systems currently in use are developmental, and it is projected that, in the future, as fossil fuels become increasingly short in supply and high in cost, solar systems will be developed in areas which are geographically suited to maximum solar collection and conversion.

**Biomass Conversion.** This involves the production of photosynthetic materials (wood, sugar cane, and other similar high Btu content crops) for use as a fuel. The photosynthetic materials can be directly combusted in coal-fed type boilers or converted

into low Btu gas by the gasification of the biomass. The technology behind biomass production and utilization closely resembles agricultural techniques and techniques evolved from the handling of coal. As a result, the utilization of biomass materials as a heat source for steam electric generation will increase as demands are placed on the coal industry to provide cleaner fuel at low prices.

**Other Natural Energy Sources.** Other major energy conversion processes (ocean thermal gradient to electricity, wind energy to electricity, photovoltaics, and solar heating and cooling of buildings and water) involve mechanical conversion or the transfer of heat without the production of steam for use as a cooling fluid.

### Magnetohydrodynamics

Magnetohydrodynamics (MHD) power generation consists of passing a hot ionized gas or liquid metal through a magnetic field to generate direct current. The concept has been known for many years, although specific research directed towards the development of viable systems for generating significant quantities of electric energy has only been in progress for the past 10 years. Magnetohydrodynamics have particular potential as a "topping" unit used in conjunction with a conventional steam turbine. Exhaust from a MHD generator is hot enough to be utilized in a waste heat boiler resulting in an overall system efficiency of 50 to 60 percent. The problem associated with MHD is the development of materials which can withstand the temperature generated. Despite its high efficiency, development of MHD to a commercial operation is not expected to occur within the next several years in the United States (1).

### Electrogasdynamics

Electrogasdynamics (EGD) produces power by passing an electrically charged gas through an electric field. The process converts the kinetic energy of the moving gas to high voltage direct current electricity. The promise of EGD is similar to the promise of MHD. Units would be smaller, would have a minimum of moving parts, would not be limited by thermal cycle efficiencies, and would not require cooling water. The system could also be adapted to any source of fuel or energy including coal, gas, oil or nuclear reactors. Unfortunately, the problems of developing commercially practical units are also similar to those associated with MHD (1).

## Fuel Cells

Fuel cells are electrochemical devices, similar to storage batteries, in which the chemical energy of a fuel such as hydrogen is converted continuously into low voltage electric current. The prospect of fuel cells is for use in residential and commercial services. However, the fuel cell is not expected to replace a significant portion of the central powerplant generator facilities within the next several years due to expense of manufacturing and the significant quantity of electric power needed to produce the cells.



## SECTION IV

### INDUSTRY CATEGORIZATION

The 1974 Development Document (1) presented the framework and rationale for the recommended industry categorization which was subsequently used in the development of chemical-type waste effluent limitations under best practicable control technology, best available technology economically achievable, and standards of performance for new sources. Factors which were considered in the development of the industry categorization included analysis of the processes employed; raw materials used; the number and size of generating facilities; their age, and site characteristics, mode of operation; wastewater characteristics; pollutant parameters, control and treatment technology; and cost, energy and non-water quality aspects. As a result, it was recommended that the industry be categorized according to the origin of individual waste sources, including condenser cooling system; water treatment, boiler or PWR steam generator, maintenance cleaning; ash handling; drainage, air pollution control devices, and miscellaneous waste streams.

Since the issuance of the 1974 Development Document (1), additional information has been collected through questionnaire surveys, plant visits, and sampling and analysis programs for priority pollutants. The steam electric power generating point source category has been reevaluated in light of this new information to determine whether categorization and subcategorization would be required for the preparation of effluent guidelines and standards for the industry. The reevaluation consisted of (1) the statistical analysis of 308 questionnaire data to assess the influence of age, size (installed generating capacity), fuel type, and geographic location on wastewater flow; and (2) engineering technical analysis to assess the influence of these and other variables on wastewater pollutant loading and the need for subcategorization.

On the basis of the reevaluation studies, EPA concluded that the existing categorization approach (by chemical waste stream origin) was adequate, but that a new format would be an improvement. The recommended categorization for the steam electric power generating point source category includes:

- 1 Once-Through Cooling Water
- 2 Recirculating Cooling System Blowdown
- 3 Fly Ash Transport Discharge
- 4 Bottom Ash Transport Discharge
- 5 Metal Cleaning Wastes
  - Air preheater wash
  - Fireside wash

- Boiler tube cleaning
- Cleaning rinses

6. Low Volume Wastes

- Clarifier blowdown
- Makeup water filter backwash
- Lime softener blowdown
- Ion exchange softener regeneration
- Demineralizer regeneration
- Powdered resin demineralizer back flush
- Reverse osmosis brine
- Boiler blowdown
- Evaporator blowdown
- Laboratory drains
- Floor drains
- Sanitary wastes
- Diesel engine cooling system discharge

7. Ash Pile, Chemical Handling and Construction Area Runoff

8. Coal Pile

9. Wet Flue Gas Cleaning Blowdown

The following subsections of this section describe the statistical analysis and engineering technical analysis performed as a part of the categorization reevaluation.

STATISTICAL ANALYSIS

Flow data from the steam electric 308 questionnaire data base were obtained for once-through cooling water, recirculating cooling system blowdown, ash transport discharge, and low volume waste discharges. Flow values were normalized by installed plant generating capacity and expressed in gallons per day per megawatt.

Four independent variables were studied to determine their effect on waste flow discharge. They were: principal fuel type (oil, coal, gas); EPA region; generating capacity; and age. The effect of these four variables on normalized waste flow discharge was tested using analysis of covariance. Results of the analysis indicated those independent variables which have a statistically significant effect on waste flow discharge and therefore warranted further consideration as a basis for subcategorization. Table IV-1 presents the independent variables which were found statistically to have an influence on normalized waste flow discharges. In general, fuel type was found to have the greatest influence on normalized discharge flow. This was expected because water requirements for ash transport and other uses normally vary among oil, coal, and gas-fired plants.

Although some statistically significant influences were found, their practical significance requires further examination. Table IV-2 lists

Table IV-1

VARIABLES FOUND TO HAVE A STATISTICALLY  
SIGNIFICANT INFLUENCE ON NORMALIZED FLOW DISCHARGES

<u>Normalized Discharge Source</u>	<u>Independent Variable</u>			
	<u>Fuel Type</u>	<u>Capacity</u>	<u>EPA Region</u>	<u>Age</u>
Once Through Cooling Water		x		
Recirculating Cooling Water Blowdown	x			
Ash Transport Discharge	x			
Low Volume Waste Discharge	x		x	

Table IV-2

PERCENT OF THE VARIATION IN NORMALIZED DISCHARGE  
 FLOWS THAT IS EXPLAINED BY THE INDEPENDENT VARIABLES

<u>Discharge Source</u>	<u>Percent of the Variation in Normalized Discharge Explained by the Inde- pendent Variables</u>
Once Through Cooling	9.6
Recirculating Cooling Water Blowdown	16.5
Ash Transport Discharge	18.6
Low Volume Waste Discharge	18.3

the percent of the variation in normalized flow discharge which is explained by the four independent variables investigated. In statistical terminology, these percentages are the square of the multiple correlation coefficient ( $R^2$ ), expressed as a percent. The relatively low  $R^2$  values indicate that although some of the independent variables were shown to statistically influence discharge, their importance is largely overshadowed by other influences. Less than 20 percent of the variation in normalized ash transport discharge was explained by the influences of fuel type, plant capacity, EPA region and plant age. The Agency therefore concluded that there was no strong statistical basis for establishing discharge source subcategories by fuel type, plant capacity, EPA region, or plant age.

### ENGINEERING TECHNICAL ANALYSIS

The objective in developing any system of industry subcategorization is to provide logical groupings of discharges based on those factors which affect the waste loading from the plant. The effect on the waste loading must be of sufficient magnitude to warrant imposition of a different treatment technology or to affect radically the performance of an existing technology.

The following characteristics of steam electric power generating plants were considered in establishing the basis for industry subcategorization:

- 1 Age
- 2 Size (Installed Generating Capacity)
- 3 Fuel Type
- 4 Intake Water Quality
- 5 Geography
- 6 Source of Raw Waste

These factors were selected as having the greatest potential effect on powerplant waste loading.

#### Age

Previous analyses (1) have shown that older plants (defined by the year the oldest currently operating boiler was placed in service) tend to be smaller, tend to have urbanized locations, and are somewhat more likely to discharge plant wastewaters to publicly owned treatment works (POTW's). Of these factors only the size of the facilities is likely to impact wastewater quality or loading. Smaller plants do have smaller discharges compared to large plants but the quality of the discharge is not appreciably different.

The biggest influence of plant age is on the economics of power generation. Older plants are less efficient than new ones and the cost of producing electricity is generally higher. It is therefore logical that capital investment in, as well as operating expenses of, pollution control equipment in older facilities can cause more economic hardship as compared to newer more efficient facilities. The economic issues are addressed in the economic evaluation being prepared as a companion document to this one.

The influence of age was judged not to be of a nature to warrant future subcategorization beyond the division by wastewaters as presented earlier.

### Size

As noted above station size (commonly expressed as installed generating capacity in megawatts) is an important factor influencing the volume of effluent flow. Discharge flows of cooling water, boiler feed water, ash handling water, and other waste streams all increase with increasing installed capacity. In general, small stations produce about the same quality of wastewater as compared to larger stations.

### Fuel Type

The type of fuel (coal, oil, gas, nuclear) used to fire powerplant boilers most directly influences the number of powerplant waste streams. The influence comes principally from the effect of fuel on the ash transport waste stream. Stations using heavy or residual oils such as no. 6 fuel oil generate fly ash in large quantities and may generate some bottom ash. This ash must be handled either dry or wet. Wet handling produces a waste stream. Stations which use wet removal methods have an ash sluice water stream that typically contains heavy metals including priority pollutants. Stations which burn coal create both fly ash and bottom ash. As in the case of oil ash, both types of coal ash can be removed either by wet or by dry methods. Those power stations using wet ash removal methods have an ash sluice water stream containing inorganic toxic pollutants such as arsenic, selenium, copper, etc.

Since fuel can affect both the presence and concentration of pollutants, fuel type does have a strong influence on waste loading and could serve as a potential basis for subcategorization. The existing categorization by waste stream source, however, does include the effect of fuel type by establishing limitations for ash transport water and further subcategorization of those waste streams by fuel type is not necessary.

### Intake Water Quality

Quality of the intake water has both a direct and an indirect effect on the waste loading and discharge flow of a power station. The direct effect is that pollutants coming into the plant tend to be

eventually discharged by the plant. The indirect effects are more complex. High concentrations of dissolved solids in the intake water can require more frequent regeneration of boiler water treatment systems. High dissolved solids content may also limit the amount of recycle of cooling water from the cooling towers, thus increasing the flow of cooling tower blowdown. High organic loadings in the raw water intake require larger doses of chlorine or other chemicals for cooling water treatment. Water quality is normally divided into three types: fresh, brackish, and salt, depending on the concentration of dissolved solids. The different types of water are believed to react differently with chlorine and other biocidal agents to produce different types and different concentrations of reaction products.

Intake water quality can affect both the flow and pollutant concentration in water discharges. However, its influence on cooling water flows is mostly dependent on the type of cooling used by the station. The influence of intake water quality is accounted for in the present categorization and was rejected as a basis for subcategorization.

#### Geographic Location

Geographic location can have an influence on power station waste concentrations and flows primarily through the affect of intake water availability and quality. The effect of intake water quality is described above. Other geographical oriented considerations have small to no effect on wastewater flow or quality.

#### Waste Stream Source

Steam electric powerplant waste stream source has the strongest influence on the presence and concentration of various pollutants as well as on flow. Waste stream source effects all aspects of waste loading. Power stations commonly have several wastewater sources, but rarely are all possible sources present at any single station. All of the sources present fit into one of the general categories. Categorization by waste source provides the best mechanism for evaluating and controlling waste loads. It was concluded that current categorization by waste stream source should be retained.





## SECTION V

### WASTE CHARACTERIZATION

#### INTRODUCTION

This study addresses only the chemical aspects of powerplant wastewater discharge. A number of different operations by steam electric powerplants discharge chemical wastes. Many wastes are discharged more or less continuously as long as the plant is operating. These include wastewaters from the following sources: cooling water systems, ash handling systems, wet-scrubber air pollution control systems, and boiler blowdown. Some wastes are produced at regular intervals, as in water treatment operations which include a cleaning or regenerative step as part of their cycle (ion exchange, filtration, clarification, evaporation). Other wastes are also produced intermittently but are generally associated with either the shutdown or startup of a boiler or generating unit such as during boiler cleaning (water side), boiler cleaning (fire side), air preheater cleaning, cooling tower basin cleaning, and cleaning of miscellaneous small equipment. Additional wastes exist which are essentially unrelated to production. These depend on meteorological or other factors. Rainfall runoff, for example, causes drainage from coal piles, ash piles, floor and yard drains, and from construction activity. A diagram indicating potential sources of wastewaters containing chemical pollutants in a fossil fueled steam electric powerplant is shown in figure V-1.

#### DATA COLLECTION

Data on waste stream characteristics presented in this section were accumulated from the following sources:

- 1 The 1974 Development document for the Steam Electric Industry (1);
- 2 Literature data available since 1974 supplied by various sources, including the steam electric industry,
- 3 Individual plant information available from approximately 800 steam electric plants responding to an EPA data collection effort (under authority of section 308 of the FWPCA),
- 4 Data from monthly monitoring reporting forms, EPA regional offices, state agencies, and other Federal agencies,
- 5 Results of screen sampling and analysis of steam electric facilities,
- 6 Results of verification sampling and analysis of steam electric facilities, and
- 7 Miscellaneous data sources

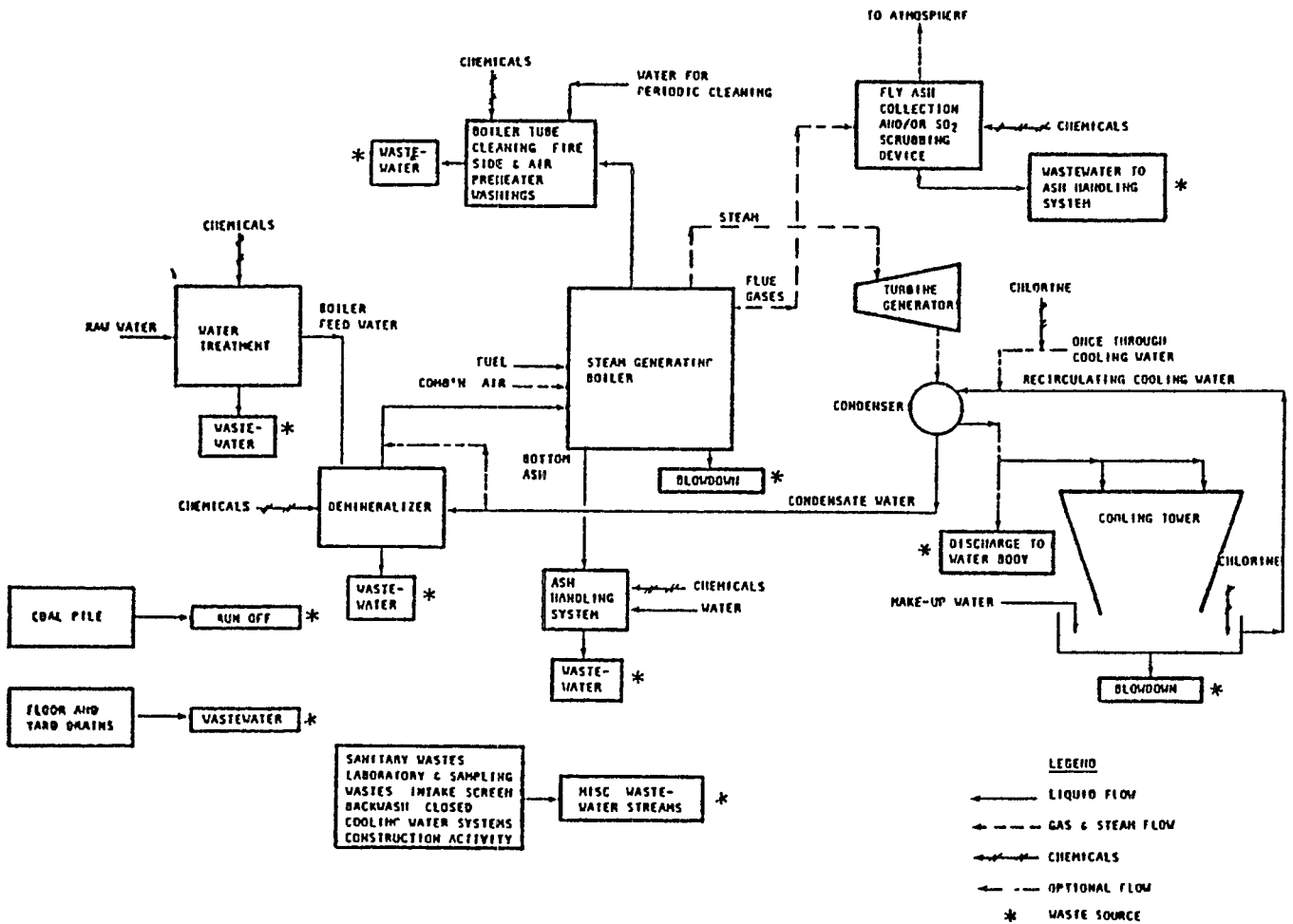

Figure V-1

SOURCES OF WASTEWATER IN A FOSSIL-FUELED  
STEAM ELECTRIC POWER PLANT (1)

Most of the historical data available cover conventional and non-conventional non-toxic pollutants such as total residual chlorine, free available chlorine, temperature, non-priority metals, oil and grease, total suspended solids (TSS), and pH. Data covering the organic priority pollutants were practically nonexistent. A two fold sampling program was conducted to fill the data void. The initial "screening" phase served to identify the presence of pollutants and the "verification" phase to quantify them. Five analytical laboratories were involved in the sampling program. All the laboratories used gas chromatography with a mass spectrometer detector (GC/MS) in analyzing for the organics (with one exception) and atomic adsorption for the metals (with two exceptions). One laboratory used a GC with a Hall detector for organic analyses. Two laboratories used the Inductively Coupled Argon Plasma Atomic-Emission Spectroscopy Method (ICAP) for metal analyses. The sampling protocol outlined in the document entitled, "Sampling and Analysis Procedures for Screening of Industrial Effluents for Priority Pollutants--April 1977 (2)", was used with some minor revisions. The revisions are described in the subsections on each waste stream.

Methylene chloride and phthalates were detected in almost all samples. The potential sources of contamination for these pollutants include sampling and analytical equipment (phthalates are used as plasticizer in tubing) and reagent used to clean and prepare sample bottles (methylene chloride). For these reasons, phthalates and methylene chloride are excluded from consideration as pollutants from powerplant operation.

#### Screen Sampling Efforts

Eight plants were chosen for example under the screen sampling phase. These plants were representative of the pollutant sources encountered in the industry; the selection of plants was based on plant variables known to affect effluent composition. The selection criteria included: fuel type, plant size, cooling type, and feed water quality. The characteristics of these eight plants are summarized in table V-1.

#### Verification Sampling Efforts

The verification sampling phase was developed to quantify pollutant loadings from the power-generating industry. Plants were chosen for this phase after consultation with industry representatives and computer scans of the 308 data base. The rationale for plant selection was based on chemical discharge waste characteristics. This phase focused primarily on the following streams: once-through cooling water, cooling tower blowdown, and ash handling waters. Although this sampling effort emphasized these major waste sources, other waste streams were also sampled.

Pollutants discharged from once-through cooling water can be attributed to corrosion of construction materials, and to the reaction of elemental chlorine as hydrochlorite with organics in the intake

Table V-1

CHARACTERISTICS OF PLANTS SAMPLED IN THE SCREEN SAMPLING PHASE  
OF THE SAMPLING PROGRAM

<u>Plant</u>	<u>Capacity (MW)</u>	<u>Fuel Type</u>	<u>Fly Ash Collection</u>	<u>Fly Ash Handling</u>	<u>Cooling Water System/ Type of Water</u>
4222	1641.7	Bituminous Coal	ESP	Once-Through Sluicing	Cooling Towers/Fresh Water
0631	169	Oil/Gas	Cyclones	Dry Handling	Cooling Towers/Fresh Water
2414	1329	Bituminous Coal	Units 1, 2. ESP Unit 3. Scrubber	Units 1, 2 Dry Handling Unit 3. Partial Recirculation Sluice System	Units 1,2. Once- Through/Fresh Water Unit 3. Cooling Tower/Fresh Water
1720	1107	Bituminous Coal	-----	Once-Through Sluicing	Once-Through/Fresh Water
3805	660	Lignite Coal	-----	Partical Recir- culating Sluice System	Once-Through/Saline Water
3404	475.6	Coal/Oil	ESP	Reinjection of Fly Ash Into Boilers	Units 1, 2 Cooling Towers/Saline Water Unit 3. Once-Through /Saline Water
2512	1120	Oil	ESP	Partial Recir- culation of Fly Ash Sluice	Once-Through/Saline Water
4836	495	Gas	-----	-----	Cooling Towers/Fresh Water

water Primary emphasis for cooling waters was placed on organics. Plants sampled during the verification program were selected on the basis of intake water quality. Powerplants with fresh water intake, brackish water intake, and saline water intake were selected because reaction kinetics for chlorinated organics formation are known to differ with the nature of the water source.

Pollutants in cooling tower blowdown may be the result of chlorination, chemical additives, and corrosion and erosion of the piping, condenser, and cooling tower materials. The Agency therefore, considered materials of construction (in particular cooling tower fills) in plant selection. Plants using the three most prevalent types of cooling tower fill were sampled. Plants with fresh, brackish, and saline water intakes were selected for chlorinated organics sampling. Since most of the powerplants were chlorinating on an intermittent basis, cooling tower and once-through cooling effluents were sampled only during periods of chlorination.

Ash handling streams contain dissolved material from the ash particles. The chemical nature of the ash material is a function of fuel composition. The four basic fuels considered were: coal, oil, natural gas, and nuclear. Natural gas-fired and nuclear-fired plants do not generate ash. Responses from the 308 letters indicate that few oil-fired plants have wet ash-sludging systems. Only one plant with oil ash handling waters was sampled. As a result, the ash transport waters from coal-fired powerplants were the primary focus. Four factors were determined to have the greatest impact on this stream. (1) sulfur content, (2) type of coal (bituminous, lignite, etc.), (3) origin of coal, and (4) type of boiler. Plants were selected under these criteria. Most coal-fired facilities have ash ponds or other means of treatment for total suspended solid removal. Samples were taken from the ash pond effluent. Table V-2 lists the powerplants sampled during the verification phase of the sampling program. Information regarding plant fuel type, installed generating capacity, ash handling systems, and cooling system type are provided in this table.

### Sampling Program Results

The results of the screening and verification sampling programs are discussed by specific waste stream in the following subsections.

#### 1. Cooling Water

- once-through
- recirculating

#### 2. Ash Handling

- combined ash ponds
- separate fly ash and bottom ash ponds

#### 3. Boiler Blowdown

Table V-2

## CHARACTERISTICS OF PLANTS SAMPLED IN THE VERIFICATION PHASE

<u>Plant No.</u>	<u>Capacity MW</u>	<u>Fuel Type</u>	<u>Fly Ash Handling System</u>	<u>Bottom Ash Handling System</u>	<u>Cooling Water System/ (Fill*)/Type of Water</u>
2718	136.9	Lignite Coal	Dry	Dry	Once-Through and Cooling Tower (Wood)/ Fresh
1716	648.5	Bituminous Coal/Gas	Dry	Wet Once-Through	Once-Through/Fresh
3414	612.9	Oil	-----	-----	Once-Through/Brackish
4826	826.3	Gas	N/A	N/A	Once-Through/Brackish
1742	22	Bituminous Coal/Oil	Dry	Wet Once-Through	Once-Through/Fresh
1245	117	Oil/Gas	-----	-----	Once-Through/Brackish Cooling Tower/Fresh
1226	1,229	Bituminous Coal/Oil/Gas	Wet Once-Through	Wet Once-Through	Once-Through and Cooling Tower (PVC)/ Fresh
4251	835	-----	-----	-----	Cooling Tower (Asbestos)/Fresh

---

NA = Not Applicable

---- = Insufficient Information

\*Type of Fill in Cooling Towers; given where appropriate.

Table V-2 (Continued)

## CHARACTERISTICS OF PLANTS SAMPLED IN THE VERIFICATION PHASE

<u>Plant No.</u>	<u>Capacity MW</u>	<u>Fuel Type</u>	<u>Fly Ash Handling System</u>	<u>Bottom Ash Handling System</u>	<u>Cooling Water System/ Type of Water</u>
3404	475.6	Bituminous Coal/Oil	Wet Once-Through	Wet Once-Through	Once-Through and Cooling Tower (Asbestos)/Brackish
5409	2,900	Bituminous Coal/Oil	Wet Once-Through	Wet Once-Through	Cooling Tower (----)/Fresh
5604	750	Bituminous Coal/Oil	Dry/Wet Recycle	Wet Once-Through/ Wet Recycle	Once-Through and Cooling Tower (----)/Fresh
4602	22	Subbituminous Coal	Dry	Wet Once-Through	Cooling Tower (Wood)/Fresh
3920	544	Bituminous Coal/Oil	Wet Once-Through	Dry/Wet Once-Through	Once-Through/----
3924	87.5	Bituminous Coal	Wet Once-Through	Wet Once-Through	Once-Through/----
3001	50.0	Lignite Coal/Gas	Wet Once-Through and Wet Recycle	Wet Once-Through	Once Through/----

---

NA = Not Applicable

---- = Insufficient Information

\*Type of Fill in Cooling Towers, given where appropriate.

Table V-2 (Continued)

CHARACTERISTICS OF PLANTS SAMPLED IN THE VERIFICATION PHASE

<u>Plant No.</u>	<u>Capacity MW</u>	<u>Fuel Type</u>	<u>Fly Ash Handling System</u>	<u>Bottom Ash Handling System</u>	<u>Cooling Water System/ Type of Water</u>
1741	99.0	Bituminous Coal	Wet Once-Through	Wet Once-Through	Cooling Ponds/----
5410	675	Bituminous Coal	Wet Once-Through	Wet Once-Through	Once-Through/----
2121	1,002.6	Bituminous Coal	Wet Once-Through	Wet Recycle (Bottom Ash Sluice Water Recycled for Fly Ash Sluicing)	Cooling Tower (----)/ ----

---

NA = Not Applicable

---- = Insufficient Information

\*Type of Fill in Cooling Towers, given where appropriate.



- 4 Metal Cleaning Wastes
- 5 Boiler Fireside Washing
- 6 Air Preheater Washing
- 7 Coal Pile Runoff

A listing of the pollutants detected in the various powerplant waste streams is given in table V-3

### COOLING WATER

In a steam electric powerplant, cooling water absorbs the heat that is liberated from the steam when it is condensed to water in the condensers. A typical type of condenser for steam electric power applications is the shell and tube condenser. A cross-sectional view of this type of condenser is provided in figure V-2. Cooling water enters the condenser through the inlet box and passes through the condenser tubes to the outlet box. As the water passes through the tubes, heat is transferred across the tube walls to the cooling water from steam contained in the condenser shell. The steam in the shell is the turbine exhaust. The transfer of heat to the cooling water results in condensation of steam on the condenser tubes. The condensate falls from the tubes to the bottom of the shell forming a pool in the hot well. The condensate is then pumped from the hot well through the feedwater train to the boiler. Cooling water is discharged from the condenser through the outlet box (3)

### Once-Through Cooling Water Systems

In a once-through cooling water system, the cooling water is withdrawn from the water source, passed through the system, and returned directly to the water source. The components of the system are the intake structure, the circulating water pumps, the condensers, and the discharge conduit. The components of a typical intake structure are the intake cowl, the conduit, and the wet well. Each intake cowl contains a bar rack to remove large objects from the water in order to protect the pumps. The wet well contains the pumps, called the circulating water pumps, and screens for removing smaller objects in the water which could damage the pumps. The relative location of the components in a particular application depends on the type of water source and various physical characteristics of the water source. The discharge from the recirculating water pumps enter a manifold that distributes the cooling water to the condensers. A manifold collects the heated water from all of the condensers and transfers the water to a conduit. The cooling water is discharged from the conduit into the receiving water body. Based on 308 data, approximately 65 percent of the existing steam electric powerplants have once-through cooling water systems. Table V-4 presents a statistical analysis of once-through cooling water flow rates reported in 308 responses from the industry.

Table V-3

SUMMARY TABLE OF ALL PRIORITY POLLUTANTS DETECTED  
 IN ANY OF THE WASTE STREAMS FROM STEAM ELECTRIC  
 POWERPLANTS BASED ON THE ANALYSIS OF THE COMPLETE  
 COMPUTERIZED DATA BASE

Benzene	Di-N-Butyl Phthalate
Chlorobenzene	Di-N-Octyl Phthalate
1,2-Dichloroethane	Diethyl Phthalate
1,1,1-Trichloroethane	Dimethyl Phthalate
1,1,2-Trichloroethane	Tetrachloroethylene
2-Chloronaphthalene	Toluene
Chloroform	Trichloroethylene
2-Chlorophenol	4,4-DDD
1,2-Dichlorobenzene	Antimony (Total)
1,4-Dichlorobenzene	Arsenic (Total)
1,1-Dichloroethylene	Asbestos (Total-Fibers/Liter)
1,2-Trans-Dichloroethylene	Beryllium (Total)
2,4-Dichlorophenol	Cadmium (Total)
Ethylbenzene	Chromium (Total)
Methylene Chloride	Copper (Total)
Bromoform	Cyanide (Total)
Dichlorobromomethane	Lead (Total)
Trichlorofluoromethane	Mercury (Total)
Chlorodibromomethane	Nickel (Total)
Nitrobenzene	Selenium (Total)
Pentachlorophenol	Silver (Total)
Phenol	Thallium (Total)
Bis(2-Ethylhexyl) Phthalate	Zinc (Total)
Butyl Benzyl Phthalate	

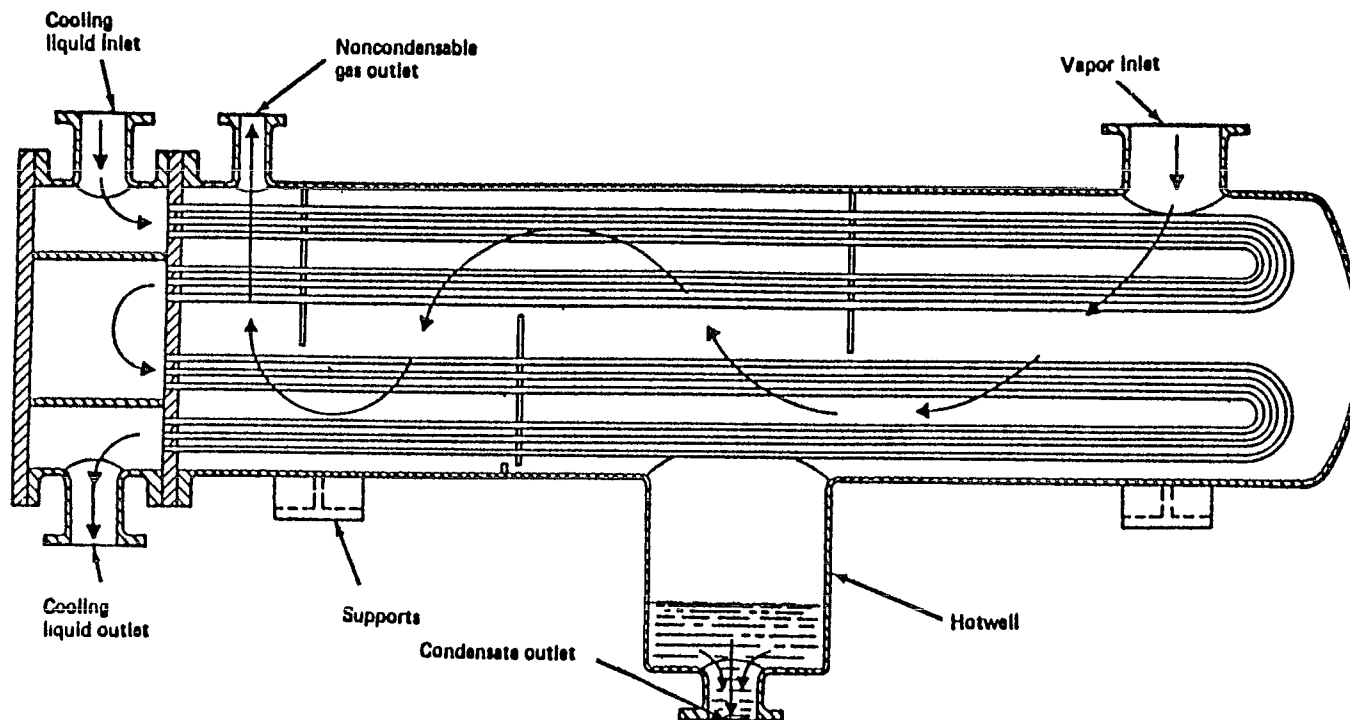

77

Figure V-2  
SHELL AND TUBE CONDENSER

Reprinted from Handbook of Chlorination by G C White by permission of Van Nostrand  
Reinhold Company Year of first publication 1972

Table V-4

ONCE-THROUGH COOLING WATER FLOWRATES  
(308 Questionnaire)

<u>Variable</u>		<u>Number of Plants</u>	<u>Mean Value</u>	<u>Standard Deviation</u>	<u>Minimum Value</u>	<u>Maximum Value</u>
<u>Fuel</u> <u>Coal*</u>						
Flow	GPD/plant	239	298,048,949	358,035,167.6	50.0	1,662,900,000
Flow	GPD/MW	239	1,140,619,218	5,030,338,485	0.347	55,430,000
<u>Fuel</u> <u>Gas*</u>						
Flow	GPD/plant	105	206,671,665.8	539,322,309.7	79.2	1,905,000,000
Flow	GPD/MW	104	636,267,895	573,486.38	1.8	3,658,536,585
<u>Fuel</u> <u>Oil*</u>						
Flow	GPD/plant	138	393,313,121.5	687,433,085.8	1.91	7,056,000,000
Flow	GPD/MW	137	1,385,121.179	4,991,663.852	0.013	58,074,074.07

---

\*Fuel designations are determined by the fuel which contributes the most Btu for power generation for the year 1975.

## Recirculating Cooling Water Systems

In a recirculating cooling water system, the cooling water is withdrawn from the water source and passed through the condensers several times before being discharged to the receiving water. After each pass through the condenser, heat is removed from the water. The heat is removed from the cooling water by three major methods: cooling ponds or cooling canals, mechanical draft evaporative cooling towers, and natural draft evaporative cooling towers.

Cooling ponds are generally most appropriate in relatively dry climates and in locations where large land areas are available. In some cases where land area is not readily available, spray facilities have been installed to reduce the needed pond size. Approximately half of the steam electric industry's cooling ponds are in the Southwest (Texas and Oklahoma), a quarter in the Southeast, and the remainder mainly in the Midwest. Cooling ponds normally have a water retention time of 10 days or more and, for a large steam electric plant, usually have a surface area in excess of 500 hectares. Chemical addition requirement for cooling ponds is significantly less than for cooling towers.

The mechanical draft evaporative cooling tower is by far the most popular cooling method for recirculating cooling water in large steam electric powerplants. The mechanical draft towers, shown in figure V-3, use fans to move air past the droplets or films of water to be cooled. Evaporation of water into the air stream provides the primary mechanism for cooling.

Like the mechanical draft towers, the natural draft towers rely on water evaporation for cooling effect. However, fans are not used to induce air through the tower. Instead, the tower is designed so that air will naturally flow from the bottom to the top of the tower as a result of density differences between ambient air and moist air inside the tower and the chimney effect of the tower's tall structure. Natural draft towers are often selected over mechanical draft towers in areas where low wet bulb temperatures and high humidity prevail. A sketch of this type of tower is shown in figure V-4.

More than 120 natural draft cooling towers were installed or planned by 1976 (6). The first towers installed in this country were concentrated in the Appalachian Mountains as a solution to the problem of getting plumes up and out of local valleys. As of 1976, however, towers were in operation or on order in 23 states. While the number of units may represent as little as 20 percent of the total number of cooling towers at powerplants, the megawatt capacity they represent is far higher since natural draft towers usually are constructed for the larger, newer plants. Natural draft cooling towers are expected to account for almost 50 percent of new generating capacity requiring cooling towers. All of the hyperbolic natural draft cooling towers built in the United States to date have been of concrete construction. Cooling tower fill can be made of polyvinyl chloride, asbestos cement, ceramic or wood.

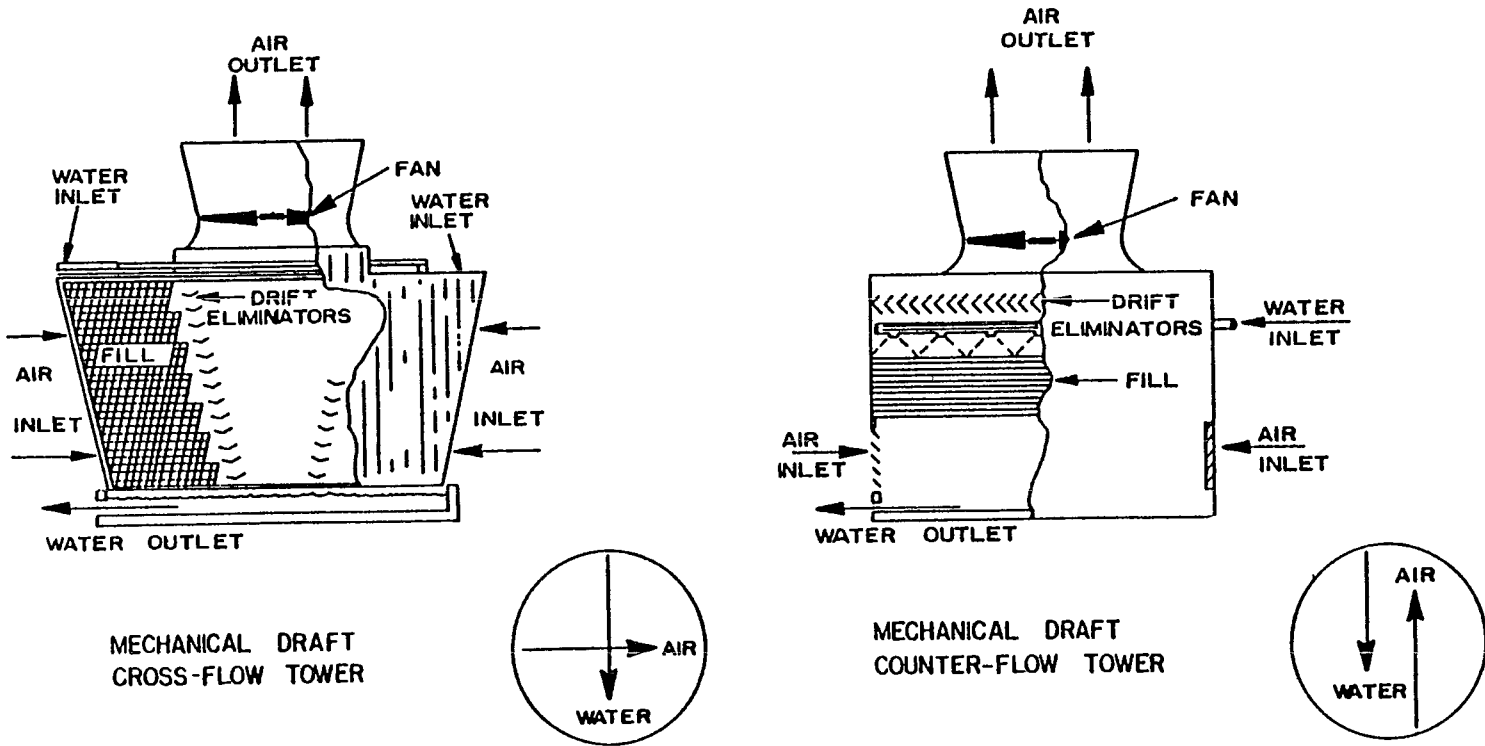

Figure V-3  
MECHANICAL DRAFT COOLING TOWERS (4)

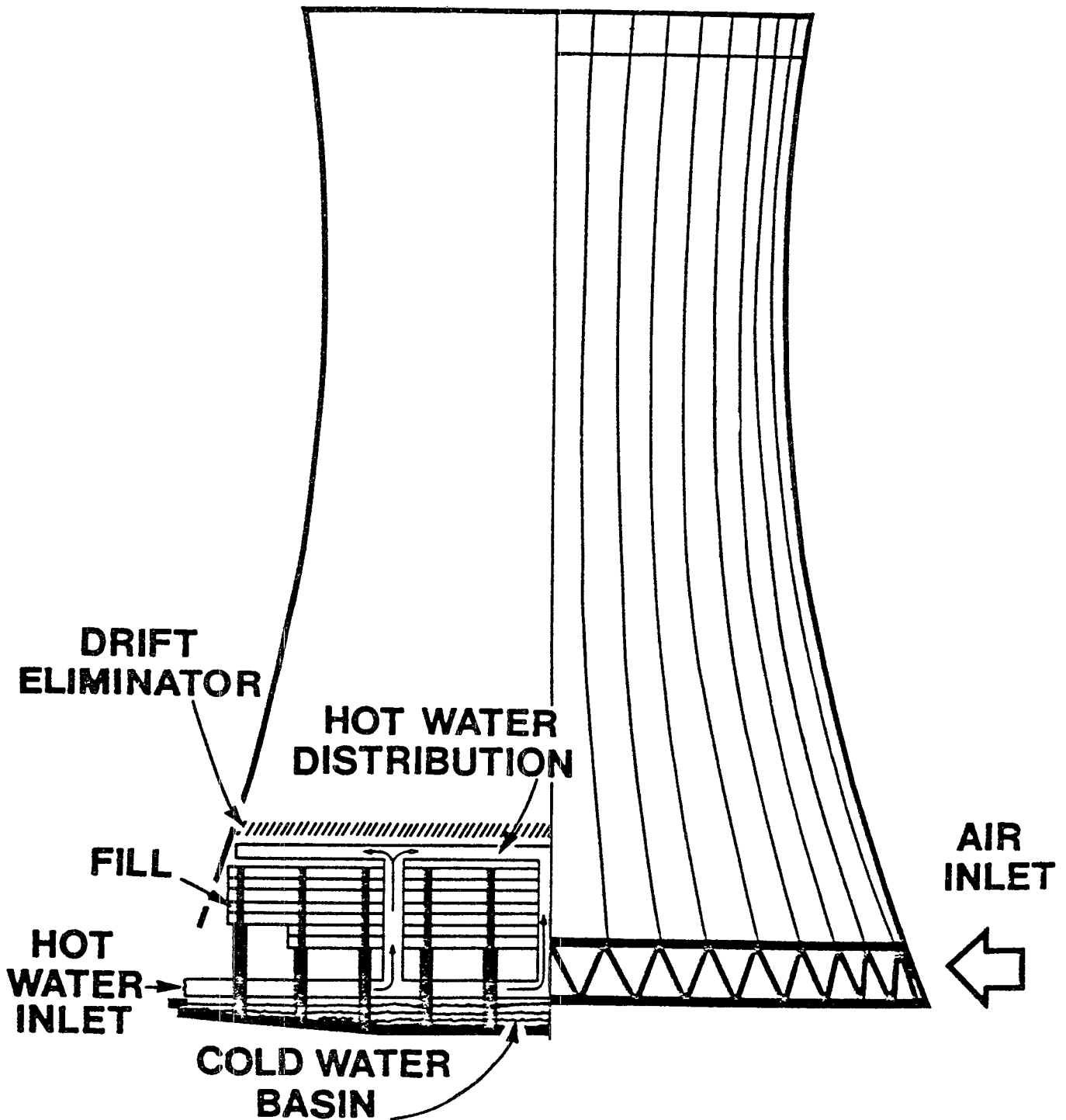

Figure V-4  
 NATURAL DRAFT EVAPORATIVE COUNTERFLOW COOLING TOWER (5)

The water that evaporates from a recirculating cooling water system in cooling ponds or cooling towers results in an increase in the dissolved solids content of the water remaining in the system; thus, the dissolved solids concentration will tend to build up over time and will eventually, if left unattended, result in the formation of scale deposits. Scaling due to dissolved solids buildup is usually maintained at an acceptable level through use of a bleed stream called cooling tower blowdown. A portion of the cooling water in the system is discharged via this stream. The discharged water has a higher dissolved solids content than the intake water used to replace the discharged water, so the dissolved solids content of the water in the system is reduced. Table V-5 presents a statistical analysis of cooling tower blowdown based on 308 data.

In some recirculating systems, chemical additives that inhibit scale formation are added to the recirculating water. These additives are discharged in the cooling tower blowdown.

### Chlorination

Biofouling occurs when an insulating layer of slime-forming organisms forms on the waterside of the condenser tubes, thus inhibiting the heat exchange process. The slime-forming organisms consist of fungi, bacteria, iron bacteria, and sulfur bacteria. The exact mechanics of biofouling are not fully understood, but the steps are believed to consist of a roughening of the metal surfaces by abrasion, attachment of bacteria and protozoa, entrapment of particulate matter by the slime growth; and the deposition of successive layers of slime-forming organisms and particulate matter (3).

Chlorination is the most widely practiced method of biofouling control for both once-through and recirculating cooling water systems. Based on the '308' data and Federal Power Commission data, about 65 percent of the 842 steam electric plants use chlorine for biofouling control. The remaining plant either do not have a significant biofouling problem or use a method of control other than chlorine. If the intake water has certain characteristics, e.g., high suspended solids concentration or low temperature, biofouling is not a problem with once-through cooling water systems. With recirculating cooling water systems, chlorination may still be required in order to protect the cooling tower. The alternatives to chlorine include other oxidizing chemicals, nonoxidizing biocides, and mechanical cleaning. None of these alternatives are widely used at this time, so chlorination is clearly the predominant method of biofouling control.

The properties of chlorine that make it an effective biofouling control agent are precisely the properties which cause environmental concern. The addition of chlorine to water causes the formation of toxic compounds and chlorinated organics which may be priority pollutants. The available information on the reaction mechanisms and products of chlorine with fresh and saline waters is summarized in the following two subsections.



Table V-5

COOLING TOWER BLOWDOWN  
(308 Questionnaire)

<u>Variable</u>		<u>Number of Plants</u>	<u>Mean Value</u>	<u>Standard Deviation</u>	<u>Minimum Value</u>	<u>Maximum Value</u>
<u>Fuel    Coal*</u>						
Flow	GPD/plant	82	2,232,131	5,452,632.6	0.00	40,300,000
	GPD/MW	82	2,973.251	7,308.87	0.00	63,056.68
<u>Fuel.   Gas*</u>						
Flow	GPD/plant	120	315,951.9	505,504.6	0.00	2,882,880
	GPD/MW	119	3,080.131	4,851.049	0.00	26,208.00
<u>Flow    Oil*</u>						
Flow	GPD/plant	47	274,193.2	584,273.3	0.00	3,200,000
	GPD/MW	47	1,862.413	3,428.478	0.00	16,712.00

\*Fuel designations are determined by the fuel which contributes the most Btu for power generation for the year 1975.

## Fresh Water

When chlorine is dissolved in water, hypochlorous acid and hydrochloric acid are formed:



The reaction occurs very rapidly. In dilute solutions with pH levels greater than 4, the equilibrium is displaced far to the right; therefore, very few chlorine molecules ( $\text{Cl}_2$ ) exist in solution. Hypochlorous acid is a weak acid that particularly dissociates in water to the hydrogen ion and the hypochlorite ion.



The equilibrium of this reaction is a function of pH as shown in figure V-5. As pH increases, the ratio of hypochlorite ion to hypochlorous acid increases. The concentrations of hypochlorous acid plus hypochlorite ion in solution is termed free available chlorine.

Chlorine may be applied to water not only in the pure  $\text{Cl}_2$  form but also in compound form, usually as hypochlorite. Hypochlorites are salts of hypochlorous acid. The two most commonly used hypochlorites are calcium hypochlorite, a solid, and sodium hypochlorite, a liquid. When sodium hypochlorite is dispersed in water, hypochlorous acid and sodium hydroxide are formed:

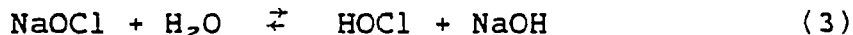

Hypochlorous acid then partially dissociates in accordance with Equation 2; therefore, whether chlorine gas or hypochlorite are added to water, the end chlorine-containing products are hypochlorous acid and hypochlorite ion.

Both hypochlorous acid and hypochlorite ion are potent oxidizing agents. The source of this oxidizing potential is the chlorine that, at a oxidation state of +1, can accept two electrons in being reduced to the -1 state. Hypochlorous acid is superior to hypochlorite ion as a biocide. The primary reason for this superiority is the relative ease with which hypochlorous acid can penetrate biological organisms. As a result of the biocidal efficiency of hypochlorous acid, an equilibrium shifted to the left in Equation 2 is preferred in most applications. The achievement of such an equilibrium position is aided by using chlorine since one of the reaction products, hydrochloric acid, lowers the pH of the water; but the achievement of this equilibrium position is impeded when using hypochlorite since one of the reaction products, sodium hydroxide, raises the pH of the water.

Since hypochlorous acid is an oxidizing agent, a considerable amount of free available chlorine may be consumed in reactions with inorganic-reducing materials in water before any biocidal effect is accomplished. Cyanide, hydrogen sulfide, iron, and manganese are

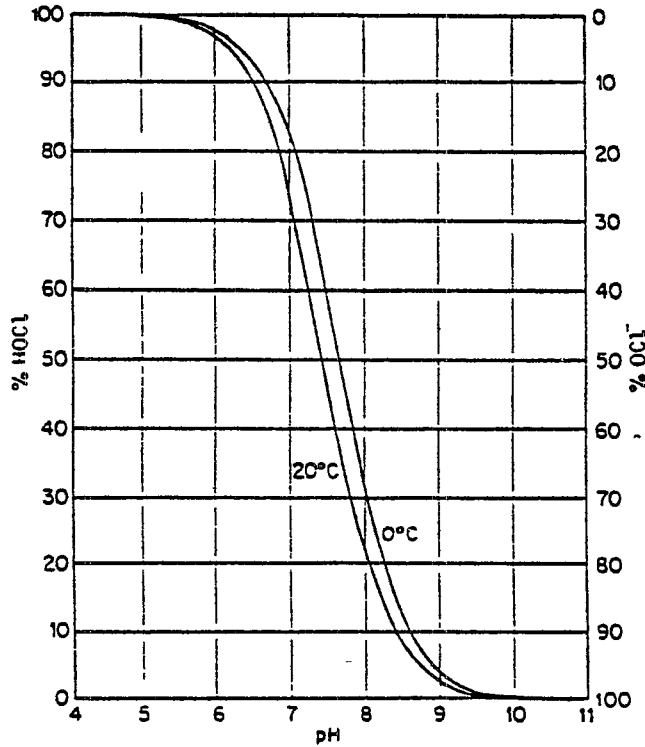

Figure V-5

EFFECT OF pH ON THE DISTRIBUTION OF HYPOCHLOROUS ACID  
AND HYPOCHLORITE ION IN WATER

Reprinted from Chemistry for Sanitary Engineers by C N Sawyer  
and P L McCarty by permission of McGraw-Hill, Inc., Year of  
first publication 1967

among the substances which can be oxidized by hypochlorous acid. In these reactions the  $\text{Cl}^+$  in hypochlorous acid is reduced to  $\text{Cl}^-$  which has no biocidal capability. The consumption of hypochlorous acid by inorganic-reducing materials is termed chlorine demand. The demand for chlorine by these substances must be satisfied before hypochlorous acid is available for biocidal activity

When sufficient hypochlorous acid is present to exceed chlorine demand, the acid will react with ammonia and organic materials. The reaction of ammonia with hypochlorous acid forms monochloramine and water:

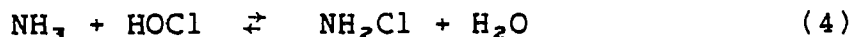

This reaction occurs when the weight ratio of chlorine to ammonia is less than or equal to 5:1. Monochloramine is a weak biocide. The reactions of organic materials with hypochlorous acid can be divided into two groups: reactions with organic nitrogen and reactions with all other organic compounds. Compounds which contain organic nitrogen are complex; therefore, the chemistry of chlorination of organic nitrogen compounds is complex. The products of the reactions of diverse organic nitrogen compounds with hypochlorous acid are grouped under the general term complex organic chloramines. The chemistry of chlorination of other organic compounds is also complex. The products of chlorination of other organic compounds are grouped under the general term chlorine substitution and addition products. The organic chloramines and the chlorine substitution and addition products are weak biocides. The chlorine contained in these compounds and in monochloramine is called combined chlorine residual. The word "residual" denotes that this is the chlorine remaining after satisfaction of chlorine demand, while the word "combined" denotes that the chlorine is tied up in compounds.

Further addition of hypochlorous acid so that the weight ratio of chlorine to ammonia exceeds 5:1 results in the conversion of some of the monochloramine to dichloramine:

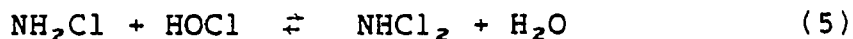

As the weight ratio of chlorine to ammonia increases to 10:1, the dichloramine and the organic chloramines and chlorine substitution and addition products begin to decompose. The exact mechanism and products of this decomposition are still incompletely defined. The decomposition consumes hypochlorous acid, so a chlorine demand is again exerted. The decomposition also decreases the combined chlorine residual level. Decomposition ceases at a weight ratio of chlorine to ammonia of 10:1. At this point, the combined available chlorine residual consists of approximately equal amounts of monochloramine and dichloramine. Like monochloramine, dichloramine is a weak biocide.

As the weight ratio of chlorine to ammonia proceeds to 20:1 through addition of hypochlorous acid, the conversion of monochloramine to

dichloramine is greatly speeded and some dichloramine is converted to trichloramine, also called nitrogen trichloride

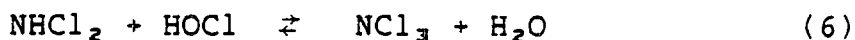

Regardless of the form of the combined available chlorine residual, the amount of the residual remains constant at the level present when the chlorine to ammonia weight ratio was 10:1. The quantity of hypochlorous acid added that is not involved in the chloramine reactions is, therefore, present as free available chlorine residual. Hypochlorous acid is, as previously stated, a powerful biocide.

The effect of various impurities in water on the disinfecting power of hypochlorous acid, described by the preceding series of equations, is illustrated in figure V-6. Total available chlorine residual, which includes both combined available chlorine residual and free available chlorine residual, is the measure of total biocidal power. As hypochlorous acid is added to water, the total available chlorine residual passes through four stages. In the first stage, no residual is formed because chlorine is being reduced by inorganic materials. In the second stage, a residual, consisting of only combined available chlorine, is formed and continuously increases as monochloramine, organic chloramines, and chlorinated organics are formed. In stage three, the residual, still consisting of only combined available chlorine, decreases as monochloramine is converted to dichloramine and the dichloramine and the organic compounds undergo further reactions. In the fourth stage, the residual increases continuously. The residual in this stage consists of both combined available chlorine and free available chlorine. In most water treatment operations, sufficient hypochlorous acid is provided to operate in stage four in order to take advantage of the biocidal power of hypochlorous acid.

A great deal of research has been conducted on the formation of chlorinated organics in fresh water. Some of the chlorinated organics are in the list of 129 priority pollutants (i.e., bromoform and chloroform). One of the experiments to examine chlorination of organics resulting from chlorinated cooling waters was performed by Jolley, et al (7). Over 50 chlorinated organics were isolated from concentrates of Watts Bar Lake water and Mississippi River water which were chlorinated at concentrations of 2.1 mg/l (75 minutes reaction time) and 3.4 mg/l (15 minutes reaction time). The chlorinated organics formed were in ppb concentrations.

In view of the finding of the National Organics Reconnaissance Survey that halogenated organics in raw and finished drinking water are widespread and distributed with a frequency shown in figure V-7, EPA Municipal Environmental Research Labs (8) sought to investigate the mechanism for the formation. Suspecting humic substances to be the precursors, they tested this hypothesis. At concentrations of humic acid representing the non-volatile total organic carbon (NVTOC) concentrations found in the Ohio River (3 mg/l), they observed that the rate of trihalomethane formation was similar to that observed in Ohio River water.

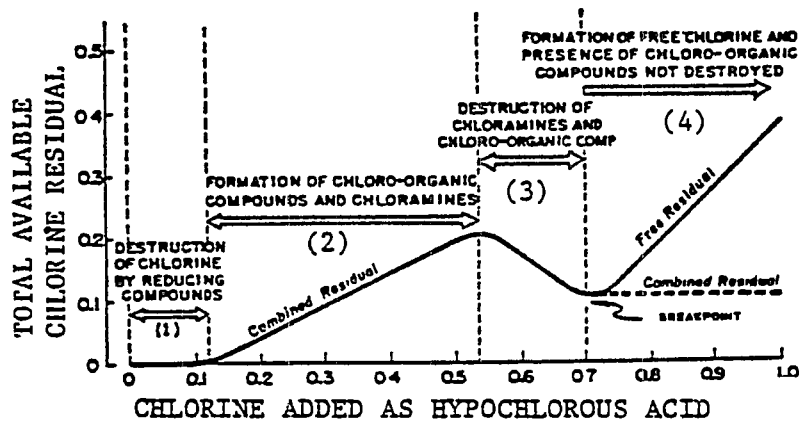

Figure V-6  
EFFECT OF IMPURITIES IN WATER ON TOTAL AVAILABLE  
CHLORINE RESIDUAL

Reprinted from Manual of Instruction for Water Treatment Plant Operators by New York State Department of Health by permission of New York State Health Education Service Year of first publication unknown.

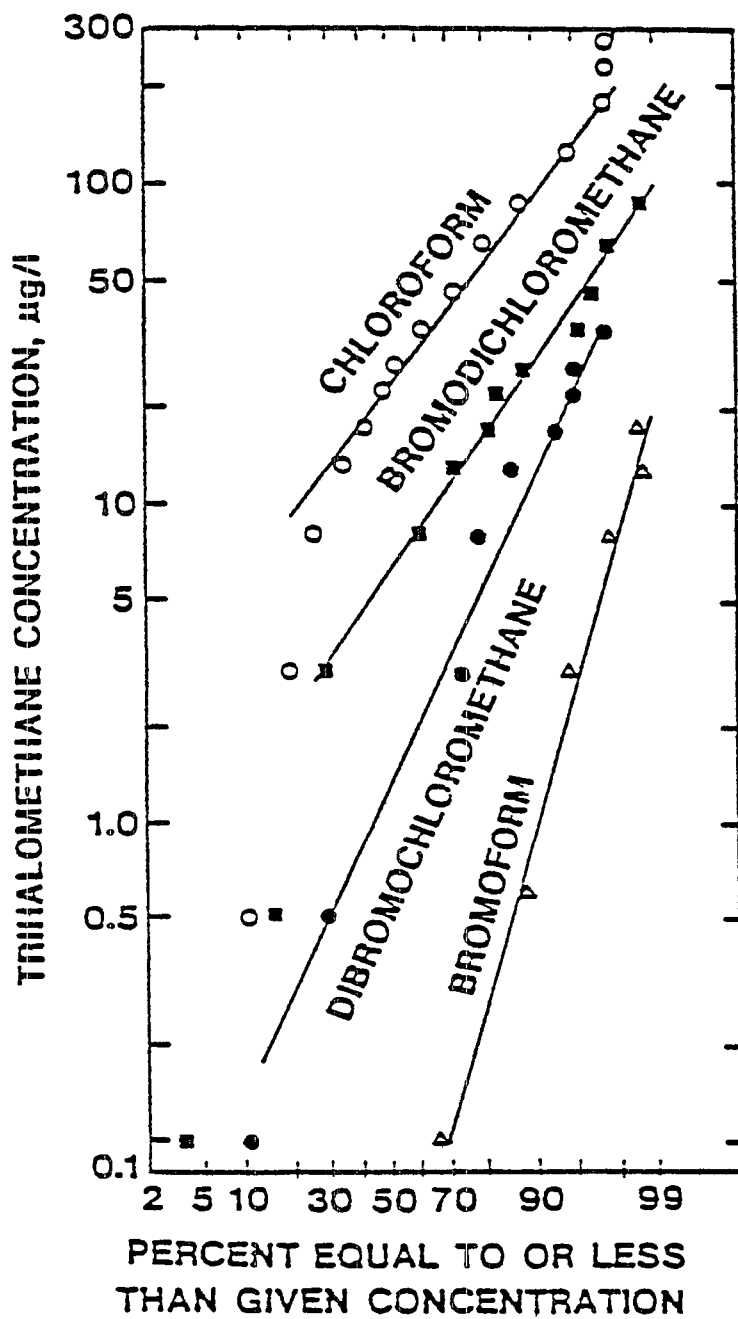

Figure V-7  
 FREQUENCY DISTRIBUTION OF HALOGENATED ORGANICS  
 IN RAW AND FINISHED DRINKING WATER (8)

The major mechanism for trihalomethane reactions in natural waters is the haloform reaction (9) that is a base catalyzed series of halogenation and hydrolysis reactions which occur typically with methyl ketones or compounds oxidizable to that structure. Humic and fulvic substances have been postulated as precursors to trichloromethane formation. Humic materials are composed of aromatic and alicyclic moieties containing alcoholic, carbonyl carboxylic, and phenolic functional groups, which can participate in trihalomethane formation by ionizing to form carbonions rapidly.

Unfortunately, data on the formation of trihalomethanes in cooling water effluents is not readily available. Several of the variables which influence chloroform formation have been investigated by the Louisville Water Company (10). A conventional treatment process of sedimentation, coagulation with alum, softening, recarbonization, and filtration is practiced. Primary disinfection is accomplished by chlorination at the head of the coagulation process. The chlorine residual leaving the plant is approximately 2.0 ppm. The correlation between total trihalomethanes and water temperature is shown in figure V-8. It is evident that seasonal variation in influent water temperature could vary the effluent chloroform concentration by a factor of 2-3 times. There are marked increases in chloroform formation with increases in pH as shown in figure V-9. Figure V-10 shows the effect of contact time on chloroform formation.

#### Saline Water

When chlorine gas is dissolved in saline water, the chemical reactions which occur initially are identical to the reactions which occur when chlorine gas is dissolved in fresh water. Once hypochlorous acid and hypochlorite ion are in equilibrium in solution, the bromide present in saline water is oxidized and hypobromous acid and hypobromite ion, respectively, are formed.

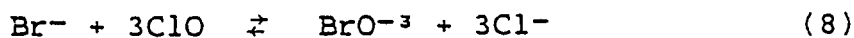
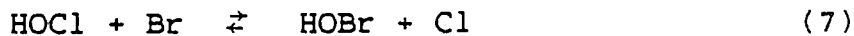

The oxidation occurs because chlorine has a higher oxidation potential than bromine. The equilibria in these reactions are normally displaced to the right; hence, hypobromous acid and hypobromite ion are more prevalent in solution than hypochlorous acid and hypochlorite ion.

The four oxidizing compounds: hypochlorous acid, hypochlorite ion, hypobromous acid, and hypobromite ion are believed to behave in saline water similarly to hypochlorous acid and hypochlorite ion in fresh water. The reactions and the reaction products in each of the four stages described for fresh water are not conclusively defined for saline water. The presence in saline water of numerous chemical species not found in fresh water leads to many side reactions triggered by the four oxidizing compounds. These side reactions



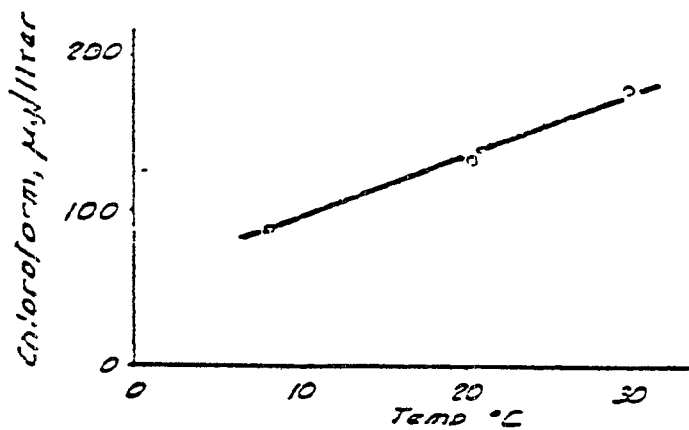

Figure V-8

EFFECT OF WATER TEMPERATURE ON THE  
CHLOROFORM REACTION

Reprinted from Hubbs, S.A., et al , "Trihalomethane Reaction at the Louisville Water Company," Louisville Water Company, Louisville, KY, undated.

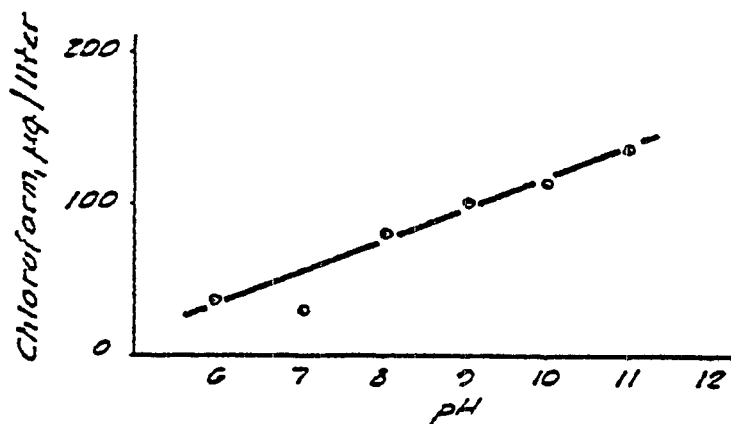

Figure V-9

EFFECT OF pH ON THE CHLOROFORM REACTION

Reprinted from Hubbs, S A , et al , "Trihalomethane Reduction at the Louisville Water Company," Louisville Water Company, Louisville, KY, undated

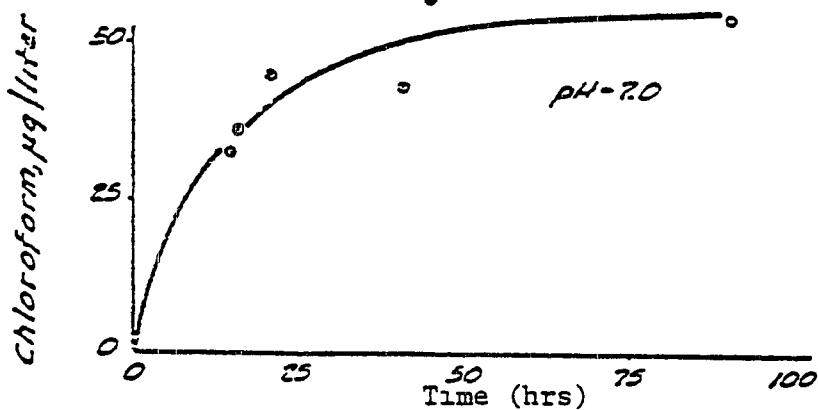

Figure V-10

EFFECT OF CONTACT TIME ON THE CHLOROFORM REACTION

Reprinted from Hubbs, S A , et al , "Trihalomethane Reduction at the Louisville Water Company," Louisville Water Company, Louisville, KY, undated

obscure the main reactions which result in the difficulty in defining the primary reactions and reaction products. In spite of this difficulty, some progress has been made in defining reaction products, particularly in Stage 4. In this stage, the free residual probably contains the four oxidizing compounds and the combined residual probably contains chloramines, bromamines, chloro-organics, and bromo-organics.

Bean, et al. (11), chlorinated Sequim Bay waters at a rate of 1-2 mg/l chlorine for approximately 2 hours. This is relatively pristine water with approximately 1 mg/l TOC. Principle reaction products were bromoform (30 mg/l) with smaller quantities of dibromomethane and traces of dichloromethane.

Carpenter (12) found that bromoform, and to a lesser extent, chlorodibromomethane were formed upon chlorination of Biscayne Bay waters. Typically, organic constituents range from 9-12 ppb dissolved organic carbon. Chlorination to 1 mg/l produced 36 ppb  $\text{CHBr}_3$  in unfiltered water and 43 ppb  $\text{CHBr}_3$  centrifuged water. It is postulated that chlorine reacts with the particulate matter and prevents oxidation of bromine to a certain extent in the former case.

### Corrosion Products

Corrosion is an electrochemical process that occurs when metal is immersed in water. A difference in electrical potential between different parts of the metal causes a current to pass through the metal between the anode, the region of lower potential, and the cathode, the region of higher potential. The migration of electrons from the anode to the cathode results in the oxidization of the metal at the anode and the dissolution of metal ions into the water (13).

Most metals rely on the presence of a corrosion products film to impart corrosion protection. In the case of copper alloys, which are used extensively in powerplant condensers, this film is usually  $\text{Cu}_2\text{O}$ . As a result, copper can usually go into the corrosion product film or directly into solution as an ion or a precipitate in the initial stages of condenser tube corrosion. As corrosion products form and increase in thickness, the corrosion rate decreases continually until steady state conditions are achieved. The data presented in table V-6 lend support to the corrosion product film theory as applied to condenser tubes. The plant that was sampled had three units. Unit 3 had just begun operation and contributed the most copper to the cooling water. Unit 1 had been in operation for a longer period of time and contributed the least amount of copper to the cooling water. Unit 2 was not considered in the comparison because mechanical cleaning was used to control biofouling which artificially increased the copper contribution to the cooling water (14).

Waters high in dissolved solids are more conductive; therefore, plants using saline water for cooling should have higher metals concentrations in the cooling water discharge than plants using fresh water. Popplewell and Hager (15) observed that the long term

Table V-6

## COPPER CORROSION DATA (14)

<u>Condenser</u>	<u>Material</u>	<u>Comment</u>	Copper Added to Cooling Water by Passing Through the Condenser*	
			<u>Soluble (ug/l)</u>	<u>Particulate (ug/l)</u>
Unit 1	Aluminum-brass 76-79 percent copper	Considered to be equilibrated with the environment	No statistically significant addition	1.28
Unit 2	90/10 copper nickel alloy	Mechanical anti- fouling system was used	6.70	7.76
Unit 3	90/10 copper nickel alloy	Had been operating intermittently for only a few months	11.8	1.8

---

\*Average of hourly samples over a 24 hour sampling period, corrected for copper concentrations at the intake.

corrosion rate of alloy 706 (90/10-copper/nickel) does not differ significantly in different environments. A summary of these results is shown in table V-7. Copper release is more a function of flow rate than it is of salt content of makeup water. A study was undertaken by a utility, (16) to determine concentrations of cadmium, chromium, copper, nickel, lead, and zinc in the influents and effluents of eight coastal generating stations. The composite data in table V-8 for all eight plants sampled shows that in 11 of the 12 available comparisons, the median difference between effluent and influent concentration was positive, suggesting a net addition of trace elements as a result of corrosion. However, only copper in the dissolved state and zinc in the suspended were increased in excess of 0.1 ppb. The data from these two studies do not indicate higher metal concentrations in saline cooling water compared to fresh cooling water and, regardless of the type of water, do not indicate that significant increases in metals concentrations are occurring because of cooling system corrosion.

Data on soluble copper concentrations in the recirculating cooling water systems at three plants are summarized in table V-9. The soluble copper concentrations in the intake water are also provided as a baseline. Copper concentrations increase markedly in the tower basin and the drift and increase dramatically in sludge in the tower basin (15). Based on this data, it appears that corrosion products are more of a problem in cooling tower blowdown (tower basin in table V-9) than in once-through cooling water discharge. The concentration of pollutants (via evaporation) in recirculating systems probably accounts for most of the difference in the level of metals observed between once-through discharge and cooling tower blowdown.

#### Products of Chemical Treatment

Chemical additives are needed at some plants with recirculating cooling water systems in order to prevent corrosion and scaling. Chemical additives are also occasionally used at plants with once-through cooling water system for corrosion control.

Scaling occurs when the concentration of dissolved materials, usually calcium and magnesium containing species, exceeds their solubility levels. Solubility levels are influenced by, among other things, water temperature and pH. The addition of scaling control chemicals allows a higher dissolved solids concentration to be achieved before scaling occurs; therefore, the amount of blowdown required to control scaling can be reduced. Control of scaling is an important plant cooling systems operational consideration. Severe scaling can drastically alter cooling systems fluid flow characteristics and result in reduced heat transfer, high pressure drops, and other undesirable effects.

Chemicals added to once-through cooling water to control corrosion or to recirculating cooling water to control corrosion and scaling will usually be present in the discharges. A list of chemicals commonly used to control corrosion and scaling is presented in table V-10 (17).

Table V-7

ONE YEAR STEADY STATE CORROSION RATES  
FOR ALLOY 706 DETERMINED EXPERIMENTALLY (15)

<u>New Haven Tap Water</u>	<u>Brackish Water 0.1% NaCl</u>	<u>Salt Water 3.4% NaCl</u>	
0.1 mils/yr	0.1 mils/yr	0.1 mils/yr	0.2 mils/yr
at velocity of 7 ft/sec	at velocity of 7 ft/sec	at velocity of 7 ft/sec	at velocity of 12 ft/sec

Table V-8

SELECTED PRIORITY POLLUTANT CONCENTRATIONS IN  
SEAWATER BEFORE AND AFTER PASSAGE THROUGH  
ONCE-THROUGH COOLING WATER SYSTEM (16)

<u>Metal</u>	<u>Median Influent Concentration</u> (ppb)		<u>Net Concentration Change (Effluent-Influent)</u> (ppb)	
	<u>Dissolved</u>	<u>Particulate</u>	<u>Dissolved</u>	<u>Particulate</u>
Cd	0.06	0.006	0.034	0.005
Cr	0.16	0.200	(0.010)*	0.097
Cu	0.80	0.320	0.21	0.10
Ni	0.44	0.160	0.10	0.004
Pb	0.14	0.24	0.04	0.07
Zn	0.20	0.48	0.09	0.17

---

\*Negative value.



Table V-9

SOLUBLE COPPER CONCENTRATIONS IN  
 RECIRCULATING COOLING WATER SYSTEMS (15)

<u>Location of sample</u>	<u>Plant 1 2 years operation</u>		<u>Plant 2 1 year operation</u>		<u>Plant 3 1 week operation</u>	
	<u>pH</u>	<u>ppb</u>	<u>pH</u>	<u>ppb</u>	<u>pH</u>	<u>ppb</u>
River influent	7.0	1.8	6.95	1	-*	-*
Tower Basin	6.45	88	6.6	35	6.9	75
Tower basin mud	-*	560,000	-*	670,000	-*	-*
Tower drift	6.43	76	6.5	34	-*	-*

---

\*Measurement not taken.

Table V-10

COMMONLY USED CORROSION AND SCALING CONTROL CHEMICALS (17)

Benzotriazole and its sodium salt  
\*Chromic Acid  
Nitrilo-tris acetic acid and its alkali metal and ammonium salts  
Organophosphorous Antiscalants including 1-Hydroxyethylidene-1,  
1-diphosphonic acid, Nitrilo-tri (methylenephosphonic acid)  
(and the alkali metal and ammonium salts of each), and  
Polyolphosphate esters of low molecular weight  
Potassium hydroxide  
Sodium bisulfate  
Sodium carbonate  
\*Sodium dichromate  
\*Sodium chromate  
Sodium hexametaphosphate  
Sodium hydroxide  
Sodium mercaptobenzothiazole  
Sodium molybdate  
Sodium nitrate  
Sodium nitrite  
Sodium phosphate (mono-, di-, tri-)  
Sodium silicates  
Sodium tetraborate  
Sodium tripolyphosphate  
Sulfamic acid  
Sulfuric acid  
Tetrasodium pyrophosphate  
Tetrapotassium pyrophosphate  
Ethylenediamine tetra-acetic acid and its alkali metal and  
ammonium salts  
Tolyltriazole  
\*Zinc chloride

Table V-10 (Continued)

COMMONLY USED CORROSION AND SCALING CONTROL CHEMICALS (17)

\*Zinc oxide  
\*Zinc sulfate  
Tannins  
Sodium Boro-polyphosphate  
\*Sodium Zinc Polyphosphate  
\*Calcium Zinc Polyphosphate  
Sodium Acid Pyrophosphate  
Phosphoric acid  
Ethylene diamine tetrakis (methylene phosphonic acid) and its  
alkali metal and ammonium salts  
Hexamethylene diamine tetrakis (methylene phosphonic acid) and  
its alkali metal and ammonium salts  
Diethylene triamine pentakis (methylene phosphonic acid) and  
its alkali metal and ammonium salts  
Sodium polystyrene sulfonate and copolymers  
Carbon dioxide  
Monobutyl esters of polyethylene - and polypropylene glycols  
Acrylamide polymers and copolymers  
Polyoxypropylene glycols (min. mol. wt. 1,000)  
Sodium carboxymethylcellulose  
Sodium lignosulfonates  
Sodium polyacrylates and polyacrylic acids  
Sodium polymethacrylates  
Styrene - maleic anhydride copolymers  
Polyethylenimines  
Sodium citrate  
Alkyphenoxy polyethoxy ethanols  
Dioctyl sodium sulfosuccinate

Table V-10 (Continued)

COMMONLY USED CORROSION AND SCALING CONTROL CHEMICALS (17)

Poly - (amine-epichlorohydrin) condensates  
Poly - demethyl, diallyl ammonium chlorides  
Poly - (amine-ethylene dichloride) condensates

---

NOTE: In many cases either sodium or potassium salts are in use.

\*Indicates that the compound is known to contain a priority pollutant. Some of the other compounds may contain or may degrade into priority pollutants but no data was available to make a definite determination.

Those compounds which are priority pollutants are marked with an asterisk to the left of the compound name. Chromium and zinc are the active components of most of the popular corrosion inhibitors. Both these metals are inorganic priority pollutants. The solvent and carrier components which may be used in conjunction with scaling and corrosion control agents are listed in table V-11 (17). The pollutants which were reported as present in recirculating cooling water on the 308 data base forms are found in table V-12. In addition to the chemicals listed in this table, acrolein and asbestos have been reported.

#### Products of Asbestos Cooling Tower Fill Erosion

The fill material in natural draft cooling towers is frequently asbestos cement. Erosion of the fill material can cause discharge of asbestos in cooling water blowdown. Table V-13 shows the test results for detection of asbestos fibers in the waters of 18 cooling systems. Baseline data on chrysotile asbestos concentrations in makeup water are also contained in the table. Seven of the 18 sites contained detectable concentrations of chrysotile asbestos in the cooling tower waters at the time of sampling. Most of the samples containing detectable chrysotile were samples of basin water. Data in the last three columns of the table for Site 3 indicate that a settling pond or lagoon interposed between the cooling towers and the receiving water removes asbestos since it was not detectable in the effluent (4).

#### Sampling Programs Results

##### Once-Through Cooling Water Systems

Three plants that use only once-through cooling water systems were sampled during the screening phase of the sampling program. Table V-14 present trace metal data for these plants from the screening program. The duration of chlorination at all three plants did not exceed 2 hours per day. Net increases were observed for antimony, arsenic, cadmium, chromium, copper, lead, mercury, nickel, selenium, thallium, and phenol. However, net increases were greater than 10 ppb only for arsenic, cadmium, nickel, selenium, and phenol. Only in the case of arsenic was the net increase greater than 25 ppb.

Eleven plants with once-through cooling water systems were sampled as part of the verification program and the surveillance and analysis sampling efforts. The analytical results are presented in Table V-15. Four of these plants have estuarine or salt water intakes, and the remaining seven plants have fresh water intakes. Samples were collected only during the period of chlorination. The samples were analyzed for all the organic priority pollutants except the pesticides, and for total organic carbon and total residual chlorine. Only the organic priority pollutants which were detected are shown. Analysis for total residual chlorine (TRC) was performed at nine of the plants.

Table V-11

SOLVENT OR CARRIER COMPONENTS THAT MAY BE USED  
IN CONJUNCTION WITH SCALING AND CORROSION CONTROL AGENTS (17)

Dimethyl Formamide  
Methanol  
Ethylene glycol monomethyl ether  
Ethylene glycol monobutyl ether  
Methyl Ethyl Ketone  
Glycols to Hexylene Glycol  
\*Heavy aromatic naphtha  
Cocoa diamine  
Sodium chloride  
Sodium sulfate  
Polyoxyethylene glycol  
Talc  
Sodium Aluminate  
Monochlorotoluene  
Alkylene oxide - alcohol glycol ethers

\*Indicates that the compound is known to contain a priority pollutant. Some of the other compounds may contain or may degrade into priority pollutants but no data was available to make a definite determination.

Table V-12

## POLLUTANTS REPORTED ON 308 FORMS IN COOLING TOWER BLOWDOWN

<u>Compound Name</u>	<u>Number of Plants Reporting Presence</u>
Antimony and compounds	3
Arsenic and compounds	2
Cadmium and compounds	3
Chlorinated phenols	7
Chloroform	1
Chromium and compounds	36
Copper and compounds	8
EDTA	6
Lead and compounds	3
Mercury and compounds	2
Nickel and compounds	3
Pentachlorophenol	9
Phenol	2
Selenium and compounds	2
Silver and compounds	2
Thallium and compounds	2
Vanadium	2
Zinc and compounds	31

Table V-13

## ASBESTOS IN COOLING TOWER WATERS (4)

Site No.	Sampling Date	Repl- lates	Asbestos, fibers/liter of H <sub>2</sub> O (sed)*									
			Makeup Water		Basin Water		Blowdown		Other			
			Lower Limit of Detection	Conc.	Lower Limit of Detection	Conc.	Lower Limit of Detection	Conc.	Sample	Lower Limit of Detection	Conc.	
1	26 May 77	a	6.3x10 <sup>4</sup>	B.D.L.	8.4x10 <sup>4</sup> sup 5.2x10 <sup>6</sup> sed	B.D.L. B D L.	6.3x10 <sup>4</sup> sup 6.4x10 <sup>6</sup> sed	B.D.L. B D L.				
		b	6.3x10 <sup>4</sup>	B.D.L.	6.3x10 <sup>4</sup> sup 4.8x10 <sup>6</sup> sed	B D L. B D L.	6.3x10 <sup>4</sup> sup 6.4x10 <sup>6</sup> sed	B.D.L. B.D.L.				
		c	6.3x10 <sup>4</sup>	B.D.L.	6.3x10 <sup>4</sup> sup 83x10 <sup>6</sup> sed	B D L. 44x10 <sup>8</sup>	6.3x10 <sup>4</sup> sup 7.5x10 <sup>6</sup> sed	B D L. B D L.				
2	26 May 77	a	6.3x10 <sup>4</sup>	B D L.	6.3x10 <sup>4</sup> sup 11x10 <sup>6</sup> sed	B.D.L. B D L.			Settling-pond effluent	6.3x10 <sup>4</sup> sup	B D L.	
		b	6.3x10 <sup>4</sup>	B D L.	6.3x10 <sup>4</sup> sup 9.1x10 <sup>6</sup> sed	B D L. B D L.			" "	4.9x10 <sup>6</sup> sed 6.3x10 <sup>4</sup> sup	B.D.L. B.D.L.	
		c	6.3x10 <sup>4</sup>	B D L.	6.3x10 <sup>4</sup> sup 7x10 <sup>6</sup> sed	B D L. B D L.			" "	5.6x10 <sup>6</sup> sed 6.3x10 <sup>4</sup> sup	B D L. B.D.L.	
3	26 May 77	a	8.4x10 <sup>4</sup>	B D L.	8.4x10 <sup>4</sup> sup 5.2x10 <sup>6</sup> sed	B D L. B D L.	8.4x10 <sup>4</sup> sup 8.4x10 <sup>4</sup> sed	B D L. B D L.	Lagoon effluent	8.4x10 <sup>4</sup>	B D L.	
		b	8.4x10 <sup>4</sup>	B D L.	8.4x10 <sup>4</sup> sup 6.4x10 <sup>6</sup> sed	B D L. B D L.	8.4x10 <sup>4</sup> sup 7x10 <sup>6</sup> sed	0.92x10 <sup>6</sup> B D L.		8.4x10 <sup>4</sup>	B D L.	
		c	8.4x10 <sup>4</sup>	B.D.L.	8.4x10 <sup>4</sup> sup	B D L.	2.6x10 <sup>6</sup> sup	110x10 <sup>6</sup>		8.4x10 <sup>4</sup>	B D L.	
4	25 May 77	a	8.4x10 <sup>4</sup> sup 7x10 <sup>6</sup> sed	B.D.L. B D L.	6.3x10 <sup>4</sup> sup 220x10 <sup>6</sup> sed	B D L. 130x10 <sup>8</sup>	8.7x10 <sup>4</sup>	1.3x10 <sup>6</sup>				
		b	8.4x10 <sup>4</sup> sup 8.4x10 <sup>6</sup> sed	B.D.L. B D L.	8.4x10 <sup>4</sup> sup LM sed	B D L. <0.5%	3.4x10 <sup>6</sup>	160x10 <sup>6</sup>				
		c	8.4x10 <sup>4</sup> sup 7x10 <sup>6</sup> sed	B D L. B D L.	8.3x10 <sup>4</sup> sup 140x10 <sup>6</sup> sed	1.9x10 <sup>6</sup> 78x10 <sup>9</sup>	1.7x10 <sup>5</sup> sup LM sed	B D L. <0.5%				
5	13 May 76	a	1.2x10 <sup>5</sup>	0.5x10 <sup>6</sup>	0.5x10 <sup>6</sup>	B D L.	0.8x10 <sup>6</sup>	B D L.	Potable water	0.12x10 <sup>6</sup>	B D L.	
6	Oct 76	a	1.57x10 <sup>5</sup>	B D L.	1.57x10 <sup>5</sup>	B D L.	1.57x10 <sup>5</sup>	B D L.				
		b			1.57x10 <sup>5</sup>	B D L.						
6	25 May 77	a	6.3x10 <sup>4</sup>	B.D.L.	8.4x10 <sup>4</sup>	B D L.	6.3x10 <sup>4</sup> sup 4.0x10 <sup>6</sup> sed	B D L. B D L.				
		b	6.3x10 <sup>4</sup>	B D L.	8.4x10 <sup>4</sup>	B D L.	6.3x10 <sup>4</sup> sup 7.0x10 <sup>6</sup> sed	B D L. B D L.				
		c	6.3x10 <sup>4</sup>	B D L.	8.4x10 <sup>4</sup>	B D L.	1.5x10 <sup>5</sup>	B D L.				
7	6 Jul 76	a	6.3x10 <sup>5</sup>	B D L.	1.26x10 <sup>6</sup>	B D L.	2.1x10 <sup>6</sup>	B D L.	Basin water from MDCI that cools MDCI blowdown	1.26x10 <sup>6</sup>	B D L.	
7 <sup>a</sup>	15 Aug 77	a	6.3x10 <sup>4</sup> sup	B D L.	6.3x10 <sup>4</sup>	All B D L.	6.3x10 <sup>4</sup>	B D L.		2.9x10 <sup>5</sup>	B D L.	
		b	6.3x10 <sup>4</sup> sup	B D L.			6.3x10 <sup>4</sup>	B D L.		6.3x10 <sup>4</sup>	B D L.	
		c	6.3x10 <sup>4</sup> sup	B D L.			6.3x10 <sup>4</sup>	B D L.		6.3x10 <sup>4</sup>	B D L.	



Table V-13 (Continued)  
 ASBESTOS IN COOLING TOWER WATERS (4)

Site No.	Sampling Date	Replicates	Asbestos, fibers/liter of $\mu\text{g/g}$ (sed)*								
			Makeup Water		Basin Water		Blowdown		Other		
			Lower Limit of Detection	Conc.	Lower Limit of Detection	Conc.	Lower Limit of Detection	Conc.	Sample	Lower Limit of Detection	Conc.
8	9 Jul 76	a	$1 \times 10^5$	B D L	$2 \times 10^5$	B D I	Towers had circulating water but no blowdown (towers not yet on line)				
		b	$1 \times 10^5$	B D I.	$1 \times 10^5$	B D L					
		c			$1 \times 10^5$	B D.L.					
9b	2 Sep 76	a	$1.88 \times 10^6$	B D I	$1.88 \times 10^6$	B D L	$1.88 \times 10^6$	$37 \times 10^6$			
		b	$1.88 \times 10^6$	B D I	$1.88 \times 10^6$	B D L	$1.88 \times 10^6$	B D I.			
		c	$1.88 \times 10^6$	B D.L	$1.88 \times 10^6$	B D I	$1.88 \times 10^6$	B D I			
10	31 Aug 76	a	$4.2 \times 10^5$	B D L.	$1.26 \times 10^6$	B D L.	$1.26 \times 10^6$	B D I			
		b	$6.3 \times 10^5$	B D L	$1.26 \times 10^6$	B D I	$1.26 \times 10^6$	B D L			
		c	$6.3 \times 10^5$	B D L	$1.26 \times 10^6$	B D I	$1.26 \times 10^6$	B D L			
11	15 Aug 77 (1 of 2 towers)	a	$2.3 \times 10^4$	B D L	$6.38 \times 10^6$	$370 \times 10^6$			Settling-basin effluent	$1.8 \times 10^5$	B D L
		b	$2.5 \times 10^4$	B D I	$6.47 \times 10^6$	$330 \times 10^6$				$2.5 \times 10^5$	B D L
		c	$2.9 \times 10^4$	B D L						$6.3 \times 10^4$	B D L
11	15 Aug 77 (2nd of 2 towers)	a			$2.9 \times 10^5$	B D L					
		b			$2.5 \times 10^5$	B D L					
		c			$6.36 \times 10^6$	$210 \times 10^6$					
12	16 Aug 77 (Unit 3 tower)	a	$6.3 \times 10^4$	B D L	$2.5 \times 10^5$	B D L			Ash-pond effluent	$6.3 \times 10^4$	B D L
		b	$2.3 \times 10^5$	B D L	$1.3 \times 10^5$	B D L				$6.3 \times 10^5$	B D I
		c	$1.2 \times 10^7$	B D L	$5.1 \times 10^7$	$24 \times 10^6$				$2.8 \times 10^5$	B D I
12	16 Aug 77 (Unit 4 tower)	a			$2.5 \times 10^5$	B D L					
		b			$2.3 \times 10^5$	B D L					
		c			$2.4 \times 10^5$	B D.L					
13	17 Feb 76	a	$1.2 \times 10^5$	B D L	$2.5 \times 10^5$	$4.3 \times 10^6$	$4.7 \times 10^5$	B D L	Cooling-tower riser	$2.5 \times 10^5$	$1.5 \times 10^6$
13	28 Apr 76	a	$4.7 \times 10^4$	$1.4 \times 10^5$ (amphibole)	$2.5 \times 10^5$	$2.5 \times 10^6$				$2.5 \times 10^5$	B D I
14c	7 May 76	a	$5.9 \times 10^5$ raw	B D L	$1.04 \times 10^6$	B D I	$1.04 \times 10^6$	B D L			
		b	$1.2 \times 10^5$ ltrtd	B D I			$1.04 \times 10^6$	B D L			
		c					$1.04 \times 10^6$	B D I			
		d					$1.04 \times 10^6$	B D I			
15	20 Jun 77	a	$6.3 \times 10^4$	B D L	$6.3 \times 10^4$	B D I	$6.3 \times 10^4$	B D L.	Park reservoir	$6.3 \times 10^4$	B D I
		b	$6.3 \times 10^4$	B D I	$6.3 \times 10^4$	B D I	$6.3 \times 10^4$	B D I		$6.3 \times 10^4$	B D I
		c	$6.3 \times 10^4$	B D I	$6.3 \times 10^4$	B D L	$6.3 \times 10^4$	B D L			
16	26 Aug 77	a	$8.4 \times 10^4$ sup	B D L			$6.3 \times 10^4$ sup	B D I	Discharge canal	$6.3 \times 10^4$ sup	B D I
		b	$8.4 \times 10^4$ sup	B D L			$6.3 \times 10^4$ sup	B D L		$6.3 \times 10^4$ sup	B D I
		c	$8.4 \times 10^4$ sup	B D L			$6.3 \times 10^4$ sup	B D I		$6.3 \times 10^4$ sup	B D I
										LM	acd
											0.5/d

Table V-13 (Continued)  
 ASBESTOS IN COOLING TOWER WATERS (4)

Site No.	Sampling Date	Replicates	Asbestos, fibers/liter of $\mu\text{g/g}$ (sed)*								
			Makeup Water		Basin Water		Blowdown		Other		
			Lower Limit of Detection	Conc.	Lower Limit of Detection	Conc.	Lower Limit of Detection	Conc.	Sample	Lower Limit of Detection	Conc.
17	21 May 76	a	$1.2 \times 10^5$	$>> 5 \times 10^6$	$6 \times 10^4$	B.D.L.	$6 \times 10^4$	B.D.L.			
17	Aug 76	a	$1 \times 10^5$	B.D.L.			$1 \times 10^5$	B.D.L.			
		b	$1 \times 10^5$	B.D.L.			$1 \times 10^5$	B.D.L.			
18	21 May 76	a	$1.2 \times 10^5$	B.D.L.	$1.2 \times 10^5$	B.D.L.					

\*Concentrations are listed as fibers/liter for bulk water samples (no postscript). In cases where the bulk samples contained appreciable amounts of suspended solids, the samples were shaken, allowed to stand 4 hours, and the supernatant analyzed by electron microscopy, results are listed in fibers/liter (sup). The sediment was analyzed either by electron microscopy or light microscopy (LM), the results of sediment analysis by electron microscopy are listed as  $\mu\text{g/g}$  (sed), and by light microscopy as a percent of the sediment mass by weight. Concentrations (Conc.) below detection limits are indicated by B.D.L. Except as otherwise noted, all asbestos was identified as chrysotile.

<sup>†</sup>Replicates taken at a given sampling date

<sup>a</sup>Site 7 has four natural-draft towers. For basin-water analyses, two samples were taken from each of the four tower basins. The lower limit of detection range from  $6.3 \times 10^4$  to  $3.0 \times 10^5$  for all eight samples.

<sup>b</sup>The lower limit of detection is relatively high due to high salt content in the water.

<sup>c</sup>Blowdown samples are from four separate mechanical-draft towers, one of which contains redwood fill.

<sup>d</sup>Chrysotile was found by light microscopy in the sediment suspended in the bulk water sample. Fibers were 2-5  $\mu\text{m}$  in diameter, 60-130  $\mu\text{m}$  in length, in small bundles.

Table V-14

## RESULTS OF SCREENING PROGRAM FOR ONCE-THROUGH COOLING WATER SYSTEMS

(parts per billion)

<u>Compounds</u>	Plant #2512		Plant #3805		Plant #1720	
	<u>Intake</u>	<u>Discharge</u>	<u>Intake</u>	<u>Discharge</u>	<u>Intake</u>	<u>Discharge</u>
Antimony	<5	10	<5	<5	7	<5
Arsenic	6	70	<5	<5	18	25
Beryllium	<5	<5	<5	<5	<5	<5
Cadmium	<10	30	<5	<5	<5	<5
Chromium	<5	8	39	<5	24	17
Copper	22	24	6	5	16	20
Cyanide	<20	<20	<20	<20	20	20
Lead	<5	<5	19	<5	8	14
Mercury	0.21	0.17	0.23	0.32	0.42	0.42
Nickel	7	25	<5	<5	29	26
Selenium	35	58	11	<5	20	18
Silver	<5	<5	12	<5	<5	<5
Thallium	<5	13	<5	<5	<5	<5
Zinc	<5	<5	<5	<5	42	26
Phenol	100	100	<10	<10	30	50

Table V-15

SUMMARY OF DATA FROM THE VERIFICATION PROGRAM AND EPA SURVEILLANCE AND  
ANALYSIS REPORTS FOR ONCE-THROUGH COOLING WATER SYSTEMS

Plant Code	Pollutant	Concentration (ppb)	
		Intake	Discharge
2718	Zinc	340	-----
	Total Dissolved Solids	230,000	380,000
	Total Suspended Solids	3,000	4,000
	Total Organic Carbon	11,000	17,000
	Total Residual Chlorine	D < 10	20/20/20/20
	1,1,2,2-Tetrachloroethane	5	5
1716	Total Dissolved Solids	250,000	360,000
	Total Suspended Solids	7,000	10,000
	Total Organic Carbon	34,000	15,000
	Phenolics, 4AAP	12	7
	Total Residual Chlorine	D < 10	400/7100/5100/D<10
3414	2,4-Dichlorophenol	ND	4/8
	Total Dissolved Solids	23,000,000	24,000,000
	Total Suspended Solids	16,000	8,000
	Total Organic Carbon	25,000	26,000
	Phenolics, 4AAP	15	7
	Total Residual Chlorine	D < 10	250/320/310/280
4826	1,2-Dichlorobenzene	ND	30
	Total Dissolved Solids	12,200,000	12,300,000
	Total Suspended Solids	17,000	21,000
	Total Organic Carbon	12,000	30,000
	Phenolics, 4AAP	8	18
	Total Residual Chlorine	D < 10	1200/2000/1900/800
	1,2 or 1,3 or 1,4 Dichlorobenzene	18	-----

Table V-15 (Continued)

SUMMARY OF DATA FROM THE VERIFICATION PROGRAM AND EPA SURVEILLANCE AND  
ANALYSIS REPORTS FOR ONCE-THROUGH COOLING WATER SYSTEMS

Plant Code	Pollutant	Concentration (ppb)	
		Intake	Discharge
1245	Total Dissolved Solids	35,000,000	33,000,000
	Total Suspended Solids	6,000	14,000
	Total Organic Carbon	14,000	25,000
	Phenolics, 4AAP	D < 5	D < 5
	Total Residual Chlorine	D < 10	D<10/200/120
1002	Bromoform	-----	31
	Chlorodibromomethane	-----	2.6
	Bis(2-Ethylhexyl) Pthalate	420	-----
	BHC(Lindane)-Gamma	-----	D < 0.1
	Antimony, Total	16	14
	Cadmium, Total	17	16
	Chromium, Total	13	14
	Copper, Total	22	24
	Lead, Total	10	11
	Mercury, Total	ND	1
	Nickel, Total	120	120
	Silver, Total	30	36
	Zinc, Total	32	24
	Total Dissolved Solids	11,488,000	13,437,000
	Total Suspended Solids	38,400	49,800
	Total Organic Carbon	8,150	7,930
	Total Residual Chlorine	0/0/200/300/400/540/900	800/310/200/250/170/150/150
	Free Residual Chlorine	200/1000/700/500/700/300/500	500/600/180/200/250/170/150/150
	Iron, Total	600	760

Table V-15 (Continued)

SUMMARY OF DATA FROM THE VERIFICATION PROGRAM AND EPA SURVEILLANCE AND  
ANALYSIS REPORTS FOR ONCE-THROUGH COOLING WATER SYSTEMS

Plant Code	Pollutant	Concentration (ppb)	
		Intake	Discharge
1742	Cadmium, Total (Dissolved)	40(5)	-----
	Chromium, Total (Dissolved)	24/20(ND/30)*	-----
	Copper, Total (Dissolved)	21/20(ND/9)*	-----
	Lead, Total (Dissolved)	9/ND<20(ND/90)*	-----
	Nickel, Total (Dissolved)	17/ND<5(ND/40)*	-----
	Silver, Total (Dissolved)	(ND/10)*	-----
	Zinc, Total (Dissolved)	ND/70(30/ND<60)*	-----
	Total Dissolved Solids	340,000	1,200,000
	Total Suspended Solids	100,000	90,000
	Total Organic Carbon	10,000	9,000
	Aluminum, Total	2,000	-----
	Barium, Total (Dissolved)	60(30)	-----
	Boron, Total (Dissolved)	90(200)	-----
	Calcium, Total (Dissolved)	51,000(44,000)	-----
	Cobalt, Total	10	-----
	Manganese Total	200	-----
	Magnesium, Total (Dissolved)	23,000(22,000)	-----
	Molybdenum, Total	9	-----
	Phenolics, 4AAP	6	260
	Total Residual Chlorine	-----	330/890/800/860
	Sodium, Total (Dissolved)	21,000(20,000)	-----
	Tin, Total	30	-----
	Titanium, Total	40	-----
	Iron, Total	4,000	-----
	Vanadium, Total (Dissolved)	ND/ND<10(ND/20)*	-----

\*These multiple results represent analyses by multiple analytical labs.

( )Values in parentheses indicate dissolved fractions.

Table V-15 (Continued)

## SUMMARY OF DATA FROM THE VERIFICATION PROGRAM AND EPA SURVEILLANCE AND ANALYSIS REPORTS FOR ONCE-THROUGH COOLING WATER SYSTEMS

Plant Code	Pollutant	Concentration (ppb)		
		Intake	Discharge	
			Chlorinated	Dechlorinated
2608	Benzene	-----	30/70/100/50/ND/1000	D<10/D<10/D<10/40/D<10/D<10 D<10/130/D<10
	2-Chloronaphthalene	ND	D<10/ND	ND
	Chloroform	-----	D<8/10/D<10/D<9/D<8/D<8	D<6/4/D<10/D<5/D<10/D<6.5 D<6/D<3/10
	1,1-Dichloroethylene	-----	ND/10/ND/40/ND/D<10	ND/ND/ND/D<10/ND/ND/ND/ND/ND
	Ethylbenzene	-----	ND/ND/ND/ND/ND/D<10	ND/ND/D<10/D<10/ND/ND/ND/D<10/ND
	Methylene Chloride	-----	210/350/10/100/ND/370	106/190/240/40/100/20/20/140/50
	Bromoform	-----	ND/ND/ND/ND/ND/ND	ND/ND/D<10/ND/ND/ND/ND/ND/ND
	Phenol (GC/MS)	ND/26*	ND/17*	ND/11*
	Butyl Benzyl Phthalate	ND	120	ND
	Di-N-Butyl Phthalate	D < 10	10	D < 10
	Toluene	-----	ND/ND/ND/ND/ND/D<10	ND/ND/D<10/D<10/ND/ND/ND D<10/ND
	Trichloroethylene	-----	D<10/D<10/D<10/ND/D<10/ND	ND/ND/ND/ND/ND/D<10/ND/ND/ND
	Antimony, Total	7	3	5
	Arsenic, Total	3	3	6
	Chromium, Total	13	13	12
	Copper, Total	7	9	11
	Mercury, Total	1.2	0.7	ND < 0.1
	Selenium, Total	ND < 2	3	ND < 2
	Zinc, Total	ND < 60	ND < 60	64
	Total Dissolved Solids	229,000	225,000	222,000
	Total Organic Carbon	6,000	6,000	6,000
	Barium, Total	10	13	11
	Calcium, Total	39,600	42,200	42,200
	Manganese, Total	53	71	59

\*These multiple results represent analyses by multiple analytical labs.

( ) Values in parentheses indicate dissolved fractions.

Table V-15 (Continued)

## SUMMARY OF DATA FROM THE VERIFICATION PROGRAM AND EPA SURVEILLANCE AND ANALYSIS REPORTS FOR ONCE-THROUGH COOLING WATER SYSTEMS

Plant Code	Pollutant	Concentration (ppb)		
		Intake	Discharge	
			Chlorinated	Dechlorinated
2608	Magnesium, Total	13,100	13,000	13,000
(Cont)	Total Residual Chlorine	-----	0/40/40/40	0/0/0/0
	Sodium, Total	D<15,000	15,000	23,000
	Iron, Total	248		
2603	Benzene	D < 10	D < 10	D < 10
	1,1,1-Trichloroethane	ND	ND	D < 10
	Chloroform	D < 10	D < 10	D < 10
	1,1-Dichloroethylene	ND	ND	D < 10
	Ethylbenzene	ND	ND	D < 10
	Methylene Chloride	D < 10	20	35
	Pentachlorophenol	ND	D < 10	ND
	Phenol (GC/MS)	ND/9*	4/ND*	4/D < 10*
	Bis(2-ethylhexyl) Phthalate	D < 10	D < 10	D < 10
	Butyl Benzyl Phthalate	D < 10	ND	ND
	Di-N-Butyl Phthalate	D < 10	20	D < 10
	Diethyl Pnthalate	50	20	D < 10
	Tetrachlete ethylene	D < 10	D < 10	D < 10
	Trichloroethylene	D < 10	D < 10	D < 10
	Arsenic, Total	ND < 2	ND < 2	3
	Chromium, Total	10	13	11
	Copper, Total	22	23	22
	Mercury, Total	0.2	0.1	0.1
	Nickel, Total	8	ND < 5	ND < 5
	Silver, Total	ND < 1	ND < 1	2
	Zinc, Total	88	68	ND < 60
	Total Dissolved Solids	292,000	271,000	247,000
	Total Organic Carbon	9,000	6,000	6,000

\*These multiple results represent analyses by multiple analytical labs.  
 ()Values in parentheses indicate dissolved fractions.



Table V-15 (Continued)

## SUMMARY OF DATA FROM THE VERIFICATION PROGRAM AND EPA SURVEILLANCE AND ANALYSIS REPORTS FOR ONCE-THROUGH COOLING WATER SYSTEMS

Plant Code	Pollutant	Concentration (ppb)		
		Intake	Discharge	
			Chlorinated	Dechlorinated
2603	Aluminum, Total	497	445	
(Cont)	Barium, Total	17	-----	689
	Boron, Total	ND < 50	140	-----
	Calcium, Total	48,700	45,300	53
	Manganese, Total	65	61	44,900
	Magnesium, Total	15,300	13,900	65
	Total Residual Chlorine	-----	D<30/200/240/270/300	14,000
	Sodium, Total	23,600	20,700	D<30/D<30/D<30/110/D<30
	Tin, Total	36	ND < 5	18,300
	Titanium, Total	18	ND < 15	ND < 5
	Iron, Total	842	715	20
	Free Residual Chlorine	-----	40/140/10	921
2607	Benzene	20	D < 10	20
	Chloroform	ND	D < 10	ND
	1,1-Dichloroethylene	10	ND	ND
	Methylene Chloride	ND	10	10
	Phenol (GC/MS)	ND/D<10*	ND/D<10*	ND/D<10*
	Bis(2-ethylhexyl) Phthalate	D < 10	D < 10	D < 10
	Di-N-Butyl Phthalate	D < 10	ND	D < 10
	Toluene	D < 10	ND	D < 10
	Trichloroethylene	ND	D < 10	D < 10
	Arsenic, Total	5	5	ND
	Chromium, Total	7	10	4
	Copper, Total	14	14	7
				14

\*These multiple results represent analyses by multiple analytical labs.  
 ()Values in parentheses indicate dissolved fractions.

Table V-15 (Continued)

## SUMMARY OF DATA FROM THE VERIFICATION PROGRAM AND EPA SURVEILLANCE AND ANALYSIS REPORTS FOR ONCE-THROUGH COOLING WATER SYSTEMS

Plant Code	Pollutant	Concentration (ppb)		
		Intake	Discharge	
			Chlorinated	Dechlorinated
2607	Selenium, Total	3.8	8.3	2.7
(Cont)	Thallium, Total	3	ND < 2	ND < 2
	Zinc, Total	ND < 60	ND < 60	73
	Total Dissolved Solids	260,000	263,000	294,000
	Total Organic Carbon	14,000	9,000	6,000
	Aluminum, Total	2,440	2,180	2,090
	Barium, Total	32	31	31
	Boron, Total	70	56	89
	Calcium, Total	44,800	35,400	43,400
	Manganese, Total	98	86	97
	Magnesium, Total	14,200	11,700	13,700
	Molybdenum, Total	ND < 5	10	ND < 5
	Total Residual Chlorine	-----	0/0/0/0/0/0	0/0/0/0/0/0
	Sodium, Total	20,500	15,500	19,800
	Titanium, Total	51	58	58
	Iron, Total	2,560	2,260	2,340
5513	Benzene	40	-----	-----
	Benzidene	ND	ND/30/40	ND
	1,1,1-Trichloroethane	ND	ND/D<10/ND	ND
	Chloroform	ND	ND/20/10	ND
	1,2-Dichlorobenzene	ND	ND/D<10	ND
	2,4-Dichlorophenol	ND	1/ND	ND
	Ethylbenzene	D < 10	ND	ND
	Methyl Chloride	50	400/50/50	10
	Bis(2-ethylhexyl) Phthalate	D < 10	ND	ND
	Di-N-Butyl Phthalate	D < 10	10	ND

\*These multiple results represent analyses by multiple analytical labs.  
 ()Values in parentheses indicate dissolved fractions.

Table V-15 (Continued)

SUMMARY OF DATA FROM THE VERIFICATION PROGRAM AND EPA SURVEILLANCE AND  
ANALYSIS REPORTS FOR ONCE-THROUGH COOLING WATER SYSTEMS

Plant Code	Pollutant	Concentration (ppb)		
		Intake	Discharge	
			Chlorinated	Dechlorinated
5513	Toluene	ND	ND/ND/D<10	ND
(Cont)	Trichloroethylene	ND	ND/ND/D<10	ND
	Antimony, Total	10	10	9
	Arsenic, Total	4	ND < 10	4
	Chromium, Total	19	25	24
	Copper, Total	8	11	10
	Cyanide, Total	10	ND < 5	ND < 5
	Lead, Total	ND < 20	34	41
	Mercury, Total	1	0.8	1.9
	Selenium, Total	3	ND < 2	3
	Silver, Total	ND < 1	3	ND < 1
	COD	35,000	33,000	33,000
	Total Dissolved Solids	545,000	526,000	506,000
	Total Suspended Solids	10,000	10,000	10,000
	Total Organic Carbon	13,000	14,000	14,000
	Aluminum, Total	283	245	289
	Barium, Total	24	18	21
	Boron, Total	83	51	50
	Calcium	84	73	76
	Cobalt, Total	D < 5	D < 5	D < 5
	Manganese, Total	66	63	62
	Magnesium, Total	33,000	30,200	30,900
	Molybdenum, Total	-----	16	14
	Phenolics, 4AAP	13	15	19
	Sodium, Total	49,000	35,000	39,700
	Tin, Total	30	ND < 5	ND < 5
	Titanium, Total	ND < 15	19	18
	Iron, Total	675	537	646
	Total Solids	612,000	-----	-----

\*These multiple results represent analyses by multiple analytical labs.  
( )Values in parentheses indicate dissolved fractions.

The data in Table V-15 indicate that there were net increases in all of the following compounds: total dissolved solids, total suspended solids, total organic carbon, total residual chlorine, free available chlorine, 2,4-dichlorophenol, 1,2-dichlorobenzene, phenolics, chromium, copper, lead, mercury, silver, iron, arsenic, zinc, barium, calcium, manganese, sodium, methylene chloride, aluminum, boron and titanium. However, the net increase was greater than 10 ppb only for 1,2-dichlorobenzene, total phenolics, lead, zinc, and methylene chloride. Only for 1,2-dichlorobenzene and total phenolics were the increases greater than 25 ppb, and in one case an increase of slightly more than 250 ppb was observed for total phenolics.

### Recirculating Cooling Water Systems

Four powerplants with cooling towers were sampled at intake and discharge points during the screening phase of the sampling program. The results of the priority pollutants analyses of these samples are presented for each plant in table V-16. The metal, organic (other than the volatile organics), and asbestos samples were 24-hour composites.

Eight powerplants with cooling towers were sampled at intake and discharge points during the verification sampling program. As noted in table V-2, plants using fresh, salt or brackish water included. The results of the verification sampling program for cooling tower blowdown are presented in table V-17.

The data presented in tables V-16 and V-17 indicate that there was a net increase from the influent concentration to the effluent concentration for the following compounds: trichlorofluoromethane, bromoform, chlorodibromomethane, bis(2-ethylhexyl) phthalate, antimony, arsenic, cadmium, chromium, mercury, nickel, selenium, silver, thallium, benzene, tetrachloroethylene, toluene, copper, cyanide, lead, zinc, chloroform, phenol, asbestos, total dissolved solids, total suspended solids, total organic carbon, total residual chlorine, 1,2-dichlorobenzene, 2,4-dichlorophenol, boron, calcium, magnesium, molybdenum, total phenolics, sodium, tin, vanadium, cobalt, iron, chloride, 2,4,6-trichlorophenol, and pentachlorophenol. It must be recognized, however, that recirculating cooling systems tend to concentrate the dissolved solids present in the make-up water and, thus, a blowdown stream with many different compounds showing concentration increases is to be expected. Of the priority pollutants detected as net discharges, the concentration increase was greater than 10 ppb only for bis(2-ethylhexyl) phthalate, cadmium, chromium, nickel, selenium, silver, toluene, copper, cyanide, lead, zinc, phenol, 1,2-dichlorobenzene, total phenolics, and 2,4,6-trichlorophenol. Net increases of greater than 25 ppb were observed for all of the following: bis(2-ethylhexyl) phthalate, cadmium, chromium, nickel, selenium, silver, toluene, copper, cyanide, lead, zinc, 1,2-dichlorobenzene, and 2,4,6-trichlorophenol. The net concentration increase exceeded 100 ppb only for bis(2-ethylhexyl) phthalate, cadmium, chromium, copper, cyanide, lead, and zinc.

Table V-16

RESULTS OF THE SCREENING PHASE OF THE  
SAMPLING PROGRAM FOR COOLING TOWER BLOWDOWNPlant 3404

<u>Pollutant</u>	<u>Concentration (ppb)</u>	
	<u>Intake</u>	<u>Discharge</u>
Benzene	1	1
Chloroform	3/1	1/1
1,4-Dichlorobenzene	ND < 1	1
1,1-Dichloroethylene	1/1	2/ND<1
Methylene Chloride	20/1	10/4
Trichlorofluoromethane	ND < 1	1
Bromoform	ND<1/ND<1	4/4
Chlorodibromomethane	ND<1/ND<1	3/3
Phenol	ND<1/36	1/<10
Bis(2-Ethylhexyl) Phthalate	11	62
Di-N-Butyl Phthalate	4	ND < 1
Toluene	3/3	6/2
Antimony, Total	11	14
Arsenic, Total	<5	8
Cadmium, Total	15	40
Chromium, Total	16	23
Copper, Total	25	13
Lead, Total	5	<5
Mercury, Total	0.34	0.58
Nickel, Total	21	29
Selenium, Total	55	87
Silver, Total	40	64
Thallium, Total	<5	9

Table V-16 (Continued)

RESULTS OF THE SCREENING PHASE OF THE  
SAMPLING PROGRAM FOR COOLING TOWER BLOWDOWN

Plant 0631

<u>Pollutant</u>	<u>Concentration (ppb)</u>	
	<u>Intake</u>	<u>Discharge</u>
Methylene Chloride	20.6	15.0
Phenol	39/20	34/40
Toluene	24.4	21
Benzene	ND < 1	1.5
Chloroform	5.7	ND < 1
Tetrachloroethylene	ND < 1	1
Toluene	47.8	115
Antimony, Total	<5	6
Arsenic, Total	<5	13
Cadmium, Total	10	25
Chromium, Total	37	75
Copper, Total	25	150
Cyanide, Total	130	360
Lead, Total	<5	17
Mercury, Total	0.41	0.91
Nickel, Total	8	100
Selenium, Total	<5	23
Silver, Total	9	32
Zinc, Total	41	67

Table V-16 (Continued)

RESULTS OF THE SCREENING PHASE OF THE  
SAMPLING PROGRAM FOR COOLING TOWER BLOWDOWNPlant 2414

<u>Pollutant</u>	<u>Concentration (ppb)</u>	
	<u>Intake</u>	<u>Discharge</u>
Benzene	2/1.3	2/1
1,2-Dichloroethane	2	ND < 1
1,1,1-Trichloroethane	1	ND < 1
Chloroform	2	3
1,4-Dichlorobenzene	1	ND < 1
Methylene Chloride	2/1	3/ND<1
Phenol	10	25
Bis(2-Ethylhexyl) Phthalate	105	262
Diethyl Phthalate	5	ND < 1
Toluene	1/1	7/10
Cis 1,2-Dichloroethylene	10/15	20/ND<1
Ethylbenzene	1	1
Antimony, Total	<5	7
Arsenic, Total	5	9
Asbestos (fibers/liter)	28,400	147,000
Chromium, Total	<5	11
Copper, Total	21	70
Cyanide, Total	<20	50
Lead, Total	7	8
Mercury, Total	0.88	1.02
Nickel, Total	8	58
Selenium, Total	15	22
Silver, Total	45	65
Thallium, Total	6	5

Table V-16 (Continued)

RESULTS OF THE SCREENING PHASE OF THE  
SAMPLING PROGRAM FOR COOLING TOWER BLOWDOWNPlant 4836

<u>Pollutant</u>	<u>Concentration (ppb)</u>	
	<u>Intake</u>	<u>Discharge</u>
Chloroform	9/6	ND<1/1
1,1-Dichloroethylene	ND<1/1	1/1
Methylene Chloride	49/8	4/4
Bromoform	1	ND < 1
Trichlorofluoromethane	ND < 1	1
Chlorodibromoform	1/1	ND<1/ND<1
Phenol	3	1
Bis(2-Ethylhexyl) Phthalate	ND < 1	1
Di-N-Butyl Phthalate	1	ND < 1
Diethyl Phthalate	2	ND < 1
Tetrachloroethylene	1/2	ND<1/ND<1
Toluene	6/3	3/3
1,4-Dichlorobenzene	1	ND < 1
Bromodichloroethylene	2	ND < 1
Antimony, Total	<5	10
Chromium, Total	6	11
Copper, Total	8	95
Cyanide, Total	62	75
Mercury, Total	0.15	0.29
Nickel, Total	6	10
Selenium, Total	<5	8
Zinc, Total	23	19



Table V-17

## SUMMARY OF RESULTS OF VERIFICATION PROGRAM FOR RECIRCULATING COOLING WATER SYSTEMS

Plant Code	Pollutant	Concentration (ppb)	
		Intake	Discharge
2718	2,4-Dichlorophenol	3	ND
	Pentachlorophenol	4	ND
	Cadmium, Total	8	4
	Chromium, Total	ND/400*	ND/300*
	Copper, Total	14/10	53/20
	Lead, Total	ND < 20	40
	Nickel, Total	ND/200*	ND/124*
	Thallium, Total	20	20
	Total Dissolved Solids	370,000	27,000,000
	Total Suspended Solids	2,000	17,000
	Total Organic Carbon	9,000	46,000
	Barium, Total	100	100
	Boron, Total	80	ND < 50
	Calcium, Total	59,000	35,000
	Cobalt, Total	10	10
	Manganese, Total	60	60
	Magnesium, Total	33,000	20,000
	Molybdenum, Total	20	20
	Phenolics, 4AAP	-----	ND < 5
	Total Residual Chlorine	ND < 10	350/280/90/10
	Sodium, Total	ND < 15,000	ND < 15,000
	Tin, Total	30	30
	Titanium	20	20
	Iron, Total	2,000	1,000
	1,1,2,2-Tetrachloroethane	ND < 5	-----

\*These multiple results represent analyses by multiple analytical labs.  
 ( ) Values in parentheses indicate dissolved fractions.

Table V-17 (Continued)

## SUMMARY OF RESULTS OF VERIFICATION PROGRAM FOR RECIRCULATING COOLING WATER SYSTEMS

Plant Code	Pollutant	Concentration (ppb)	
		Intake	Discharge
1245	1,2-Dichlorobenzene	ND	26
	2,4-Dichlorophenol	3	8
	Pentachlorophenol	-----	4
	Cadmium, Total	ND < 2	5
	Chromium, Total	83/20*	55/40*
	Copper, Total (Dissolved)	12/ND<6*	70/30*
	Nickel, Total	ND/ND<5*	ND/10*
	Silver, Total	ND < 1	2
	Total Dissolved Solids	900,000	2,240,000
	Total Suspended Solids	2,000	4,000
	Total Organic Carbon	22,000	76,000
	Boron, Total	500	2,000
	Calcium, Total	53,000	140,000
	Manganese, Total	8	ND < 3
	Magnesium, Total	22,000	48,000
	Molybdenum, Total	ND < 5	40
	Phenolics, 4AAP	7	20
	Total Residual Chlorine	1,170	0/0/0/0/0
	Sodium, Total	170,000	350,000
	Fin, Total	ND < 5	30
Vanadium, Total	ND < 3	10	

\*These multiple results represent analyses by multiple analytical labs.  
 ()Values in parentheses indicate dissolved fractions.

Table V-17 (Continued)

## SUMMARY OF RESULTS OF VERIFICATION PROGRAM FOR RECIRCULATING COOLING WATER SYSTEMS

Plant Code	Pollutant	Concentration (ppb)	
		Intake	Discharge
1226	Chloroform	-----	D < 1
	Bromoform	-----	154
	Dichlorobromomethane	-----	8.2
	Chlorodibromomethane	-----	58.5
	Antimony, Total	ND/7*	7
	Arsenic, Total	ND/3*	ND/4*
	Cadmium, Total	2.1/ND<2*	1.8/ND<2*
	Chromium, Total	ND/7/7*	28/5/20*
	Copper, Total (Dissolved)	10/12/10*(10)	47/50*
	Lead, Total (Dissolved)	12/10/ND<20*(7/ND/20)*	3/ND<20*
	Mercury, Total	ND<1/0.5*	0.2
	Nickel, Total (Dissolved)	27/1.5/ND<5*(29/ND*)	6/6/ND<5*
	Silver, Total	ND/1.3/ND<1*	0.7/ND<1*
	Zinc, Total (Dissolved)	ND/9/70*(50/ND<60)*	50/26/ND<60*
	Total Dissolved Solids	190,000	1,050,000
	Total Suspended Solids	14,000	8,000
	Total Organic Carbon	10,000	11,000
	Aluminum, Total (Dissolved)	700(100)	400
	Barium, Total (Dissolved)	20(20)	20
	Boron, Total	ND < 50	60
	Calcium, Total (Dissolved)	6,900(D<5000)	6,900
	Cobalt, Total	7	8
	Manganese, Total (Dissolved)	200(200)	100
	Magnesium, Total (Dissolved)	4,500(5000)	4,900
	Phenolics, 4AAP	12	8
	Total Residual Chlorine	ND	D<10/D<10/D<10/D<10/D<10/D<10/90/D<10
	Sodium, Total (Dissolved)	33,000(36,000)	210,000

\*These multiple results represent analyses by multiple analytical labs.  
 ()Values in parentheses indicate dissolved fractions.

Table V-17 (Continued)

## SUMMARY OF RESULTS OF VERIFICATION PROGRAM FOR RECIRCULATING COOLING WATER SYSTEMS

Plant Code	Pollutant	Concentration (ppb)	
		Intake	Discharge
1226	Titanium, Total	20	20
(Cont'd)	Iron, Total (Dissolved)	2,000(1,000)	3,000
	Vanadium, Total	ND/40/ND<10*	27/ND<10
	Lead (Dissolved)	(7/ND<20*)	-----
4251	1,2-Dichlorobenzene	ND	20
	2,4-Dichlorophenol	11	ND
	Cadmium, Total	9	ND < 2
	Chromium, Total	42/500*	10/10*
	Copper, Total	55/20*	81/40*
	Lead, Total	30	ND < 20
	Nickel, Total	24/200*	42/10*
	Zinc, Total	340/ND<60*	40/ND<60*
	Total Dissolved Solids	227,000	430,000
	Total Suspended Solids	10,000	53,000
	Total Organic Carbon	34,000	15,000
	Barium, Total	40	-----
	Boron, Total	60	70
	Calcium, Total	29,000	ND/53,000*
	Cobalt, Total	10	ND < 5
	Manganese, Total	200	70
	Magnesium, Total	7,600	8,900
	Molybdenum, Total	20	ND < 5
	Phenolics, 4AAP	16	8
	Total Residual Chlorine	D < 10	100/4100/6500/6200/5200/4300/3950/ 3400/2800/2500/2000/1550/1300/750
	Sodium, Total	17,000	52,000
	Iron, Total	2,000	300

\*These multiple results represent analyses by multiple analytical labs.

()Values in parentheses indicate dissolved fractions.

Table V-17 (Continued)

## SUMMARY OF RESULTS OF VERIFICATION PROGRAM FOR RECIRCULATING COOLING WATER SYSTEMS

Plant Code	Pollutant	Concentration (ppb)	
		Intake	Discharge
3404	1,2-Dichlorobenzene	18	ND
	2,4-Dichlorophenol	12	8
	Pentachlorophenol	12	4
	Cadmium, Total	100	200
	Chromium, Total	78/800*	110/1000*
	Copper, Total	33/ND<60*	24/60
	Lead, Total	500	800
	Nickel, Total	34/100*	78/200*
	Silver, Total	40	80
	Total Dissolved Solids	26,000,000	34,000,000
	Total Suspended Solids	110,000	90,000
	Total Organic Carbon	26,000	9,000
	Aluminum, Total	2,000	2,000
	Boron, Total	4,000	4,000
	Calcium, Total	340,000	460,000
	Cobalt, Total	ND < 50	80
	Manganese, Total	200	100
	Molybdenum, Total	80	100
	Phenolics, 4AAP	5	-----
	Total Residual Chlorine	ND<10/ND<10/ND<10/ND<10	230/190/390/170
	Sodium, Total	6,000,000	7,000,000
	Tin, Total	300	500
	Titanium, Total	200	200
Iron, Total	4,000	4,000	
Vanadium, Total	200	200	

\*These multiple results represent analyses by multiple analytical labs.

()Values in parentheses indicate dissolved fractions.

Table V-17 (Continued)

## SUMMARY OF RESULTS OF VERIFICATION PROGRAM FOR RECIRCULATING COOLING WATER SYSTEMS

Plant Code	Pollutant	Concentration (ppb)	
		Intake	Discharge
5409	Benzene	2.4	1.5
	Carbon Tetrachloride	D < 1	-----
	Chloroform	1.4	2.4
	1,2-Dichlorobenzene	5.3	-----
	Dichlorobromomethane	-----	2.6
	Chlorodibromomethane	-----	D < 1
	Toluene	2	-----
	Trichloroethylene	4	4
	Cadmium, Total	1.4	1
	Chromium, Total	ND < 2	37
	Copper, Total (Dissolved)	27	3,800(620)
	Cyanide, Total	15,000	5
	Lead, Total (Dissolved)	8	130(70)
	Mercury, Total	ND < 0.2	1
	Nickel, Total	1.7	4
	Selenium, Total	2	ND < 2
	Silver, Total	1.6	14
	Thallium, Total	ND < 1	8
	Zinc, Total (Dissolved)	15	290(61)
	Total Suspended Solids	5	460,000
	Total Organic Carbon	20,000	21,000
	Chloride	-----	110,000
Vanadium, Total	13	17	
1,3 and 1,4-Dichlorobenzene	2.4	-----	

\*These multiple results represent analyses by multiple analytical labs.

()Values in parentheses indicate dissolved fractions.

Table V-17 (Continued)

## SUMMARY OF RESULTS OF VERIFICATION PROGRAM FOR RECIRCULATING COOLING WATER SYSTEMS

Plant Code	Pollutant	Concentration (ppb)	
		Intake	Discharge
5604	Benzene	1.2	D < 1
	Toluene	9.1	23.5
	Antimony, Total	4	5
	Arsenic, Total	ND < 1	7
	Chromium, Total	ND < 2	2
	Copper, Total	700	180
	Cyanide, Total	4	3
	Lead, Total	6	ND < 3
	Nickel, Total	ND < 0.5	6
	Selenium, Total	2	ND < 2
	Silver, Total	ND < 3	3
	Zinc, Total	53	780
	Total Suspended Solids	-----	42,000
	Total Organic Carbon	5,500	14,000
	Chloride	14,000	54,000
	Vanadium, Total	11	24

\*These multiple results represent analyses by multiple analytical labs.

( ) Values in parentheses indicate dissolved fractions.

Table V-17 (Continued)

## SUMMARY OF RESULTS OF VERIFICATION PROGRAM FOR RECIRCULATING COOLING WATER SYSTEMS

Plant Code	Pollutant	Concentration (ppb)	
		Intake	Discharge
4602	2,4,6-Trichlorophenol	ND	35
	Pentachlorophenol	ND	4
	Cadmium, Total	ND < 20	5
	Chromium, Total	73/100*	130/400*
	Copper, Total	21/50*	62/400*
	Lead, Total	30	ND < 30
	Nickel, Total	98/ND<5*	60/200*
	Silver, Total	2	ND < 1
	Zinc, Total	ND/70*	210/200*
	Total Dissolved Solids	190,000	880,000
	Total Suspended Solids	2,000	2,000
	Total Organic Carbon	D < 1000	9,000
	Barium, Total	300	200
	Boron, Total	300	60
	Calcium, Total	260,000	110,000
	Cobalt, Total	8	10
	Manganese, Total	90	50
	Magnesium, Total	100,000	57,000
	Molybdenum, Total	20	60
	Phenolics, 4AAP	D < 5	D < 5
	Total Residual Chlorine	D < 10	7340/4730/190/50
	Sodium, Total	95,000	33,000
	Tin, Total	60	60
	Titanium, Total	30	ND < 20
	Iron, Total	1,000	2,000
	Vanadium, Total	20	20

\*These multiple results represent analyses by multiple analytical labs.  
 ()Values in parentheses indicate dissolved fractions.



### Additional Data Sources

Another source of useful data is a study on the chlorination of a fresh water once-through cooling system that found that chloroform levels in the outlet from the condenser during periods of chlorine addition ranged between 1.4 and 8.7 ppb (47). The mean chloroform concentration in the condenser outlet during chlorination was 5.0 ppb. The intake in this same study had chloroform levels consistently below 1.0 ppb with the exception of one sample point at 1.2 ppb.

Samples were also analyzed for dichlorobromomethane in this same study (47). Condenser outlet dichlorobromomethane levels ranged from 0.9 to 4.6 ppb during the period of chlorine addition. The mean dichlorobromomethane level was 2.0 ppb. Intake water had dichloromethane levels consistently below 0.2 ppb.

Analysis was also done for dibromochloromethane (47). Condenser outlet dibromochloromethane levels ranged from less than 0.2 ppb to 1.5 ppb during the period of chlorine addition. The mean dibromochloromethane level was 0.77 ppb but in three samples the level of dibromochloromethane could not be quantified; these samples were not used in calculating the mean. Intake water was consistently below 0.2 ppb dibromochloromethane.

### Summary of the Results of Cooling Water Sampling and Data Collecting Efforts

An examination of all the available data, including screening, verification, surveillance and analysis, and literature data, leads to several major conclusions. First, net discharges of metals other than chromium and zinc are the result of corrosion of metal surfaces within the cooling water system. Net discharges from once-through systems are typically less than 20 ppb. Net discharges from recirculating cooling systems may be higher because of the concentrating effect these systems have on dissolved solids. Net discharges of chromium and zinc from recirculating systems may be as high as 1,000 ppb zinc and 200 ppb chromium as the result of the use of corrosion control additives (13).

Second, the organic pollutants that were detected in the sampling efforts may result from several sources. Methylene chloride may be a product of chlorination or, since it is a common lab solvent, may be an analytical error. Bis (2-ethylhexyl) phthalate is probably the result of the loss of plasticizers from plastic sampling tubes or bottles. 2,4-dichlorophenol, 1,2-dichlorobenzene, bromoform, chlorodibromomethane, and chloroform all may result from cooling water chlorination. Net discharges of these compounds were always at or below 30 ppb, often only a few ppb. The concentration scale up effect of recirculating cooling systems may account for increases in some of the organics. The use of non-oxidizing biocides may explain the presence of compounds like phenol, benzene, toluene, 1,2-dichlorobenzene, 2,4,6-trichlorophenol and pentachlorophenol (13,17).

A third major finding was a net discharge of asbestos in the cooling tower blowdown of plant 2414. Since asbestos was also present in the make-up water, it is not clear whether fill erosion is occurring. The introduction of asbestos into cooling tower blowdown from fill erosion has already been demonstrated by the data presented in table V-13.

Finally, net discharges of total residual chlorine were observed in both once-through and recirculating systems. Net discharges as high as 7,100 pph were observed.

### ASH HANDLING

Steam electric powerplants using oil or coal as a fuel produce ash as a waste product of combustion. The total ash product is the combination of bottom ash and fly ash. Bottom ash is the residue which accumulates on the furnace bottom, and fly ash is the lighter material which is carried over in the flue gas stream. In coal-burning boilers, some of the fly ash or carryover ash settles in the economizer section of the boiler. This ash is called economizer ash and is typically the larger particles of the fly ash.

The ash composition of oil, on a weight percent basis, is much lower than that of coal. Oil ash seldom exceeds 0.2 percent, whereas coal ash comprises from 3 to 30 percent of the coal. As such, the presence of ash is an extremely important consideration in the design of a coal-fired boiler and, to a lesser extent, an oil-fired boiler. Improper design could lead to accumulation of ash deposits on furnace walls and tubes, leading to reduced heat transfer, increased pressure drop, and corrosion.

Ash handling or transport is the conveyance of the accumulated waste products to a disposal system. The method of conveyance may be either wet (sluicing) or dry (pneumatic). Dry handling systems are more typical for fly ash than bottom ash. The method of disposal for a dry ash is commonly by landfill but the ash can also be sold as a by-product for a variety of uses such as an ingredient for road pavement or for portland cement (alkaline ashes). Ash from oil-fired units is often sold for the recovery of vanadium.

Wet ash handling systems produce wastewaters which are currently either discharged as blowdown from recycle systems or discharged directly to receiving streams in a once-through manner. Statistical analyses of fly ash and bottom ash wastewater flow rates reported in 308 responses from the industry are presented in tables V-18 and V-19. The chemical characteristics of ash handling wastewater are basically a function of the inlet or makeup water, composition of the fuel burned, and the composition of other wastewaters discharged into the ash settling ponds. These characteristics are discussed in this section.

Table V-18

FLY ASH POND OVERFLOW  
(308 Questionnaire)

<u>Variable</u>		<u>Number of Plants</u>	<u>Mean Value</u>	<u>Standard Deviation</u>	<u>Minimum Value</u>	<u>Maximum Value</u>
<u>Fuel. Coal*</u>						
Flow.	GPD/plant	167	2,610,724.6	3,397,528.7	0.00	23,000,000
	GPD/MW	166	3,807.976	3,608.152	0.00	16,386.91
<u>Fuel. Gas*</u>						
Flow	GPD/plant	21	322,170.0	764,538.7	0.00	3,250,000
	GPD/MW	21	1,899.28	3,026.676	0.00	11,535,049
<u>Flow. Oil*</u>						
Flow	GPD/plant	47	487,996.2	1,607,619.2	0.00	9,750,000
	GPD/MW	47	828.552	1,652.856	0.00	7,485.76

\*Fuel designations are determined by the fuel which contributes the most Btu for power generation for the year 1975.

Table V-19

BOTTOM ASH POND OVERFLOW  
(308 Questionnaire)

<u>Variable</u>	<u>Number of Plants</u>	<u>Mean Value</u>	<u>Standard Deviation</u>	<u>Minimum Value</u>	<u>Maximum Value</u>
<u>Fuel. Coal*</u>					
Flow. GPD/plant	219	2,600,998.7	5,072,587.5	0.00	33,600,000
GPD/MW	218	3,880.983	5,147.284	0.00	38,333.33
<u>Fuel. Gas*</u>					
Flow. GPD/plant	25	417,345.2	1,026,066.7	0.00	4,020,000
GPD/MW	25	1,804.65	3,229.089	0.00	11,535.049
<u>Flow. Oil*</u>					
Flow. GPD/plant	40	322,913.6	907,839.3	0.00	4,900,000
GPD/MW	40	622.696	1,698.706	0.00	9,902.53

\*Fuel designations are determined by the fuel which contributes the most Btu for power generation for the year 1975.

## Fly Ash From Oil-Fired Plants

The ash from fuel oil combustion usually is in the form of fly ash. The relatively small quantity of ash (compared to coal) is capable of causing severe problems of external deposits and corrosion in boilers. The many elements which may appear in oil ash deposits include vanadium, sodium, and sulfur. Compounds containing these elements are found in almost every deposit in boilers fired by residual fuel oil and often constitute the major portion of these deposits.

### Origin of Crude Oil Ash

Some of the ash-forming constituents in the crude oil had their origin in animal and vegetable matter from which the oil was derived. The remainder is extraneous material resulting from contact of the crude oil with rock structures and salt brines or picked up during refining processes, storage, and transportation.

In general, the ash content increases with increasing asphaltic constituents in which the sulfur acts largely as a bridge between aromatic rings. Elemental sulfur and hydrogen sulfide have been identified in crude oil. Simpler sulfur compounds, including thioesters, disulfides, thiophenes, and mercaptans, are found in the distillates of crude oil.

Vanadium, iron, sodium, nickel, and calcium in fuel oil are common in rock strata, but elements including vanadium, nickel, zinc, and copper are believed to come from organic matter from which the petroleum was created. Vanadium and nickel are known to be present in organo-metallic compounds known as porphyrins which are characteristic of certain forms of animal life. Table V-20 summarizes the amounts of vanadium, nickel, and sodium present in residual fuel oils from various crudes.

Crude oil, as such, is not normally used as a fuel but is further processed to yield a wide range of more valuable products. For example, in a modern United States refinery, the average product yield, as a percentage of total throughput, is given in table V-21. Virtually all metallic compounds and a large part of the sulfur compounds are concentrated in the distillation residue, as illustrated for sulfur in table V-22. Where low-sulfur residual fuel oils are required, the oil is obtained by blending with suitable stocks, including both heavy distillates and distillation from low-sulfur crudes. This procedure is used occasionally if a residual fuel oil must meet specifications such as vanadium, or ash content.

### Release of Ash During Combustion

Residual fuel oil is preheated and atomized to provide enough reactive surface to burn completely within the boiler furnace. The atomized fuel oil burns in two stages. In the first stage, the volatile portion burns and leaves a porous coke residue; and, in the second stage, the coke residue burns. In general, the rate of combustion of

Table V-20

VANADIUM, NICKEL, AND SODIUM CONTENT OF  
RESIDUAL FUEL OIL (18)

(parts per million by weight)

<u>Source of Crude Oil</u>	<u>Vanadium</u>	<u>Nickel</u>	<u>Sodium</u>
<b>Africa</b>			
1	5.5	5	22
2	1	5	--
<b>Middle East</b>			
3	7	--	1
4	173	51	--
5	47	10	8
<b>United States</b>			
6	13	--	350
7	6	2.5	120
8	11	--	84
<b>Venezuela</b>			
9	--	6	480
10	57	13	72
11	380	60	70
12	113	32	49
13	93	--	38

Table V-21

AVERAGE PRODUCT YIELD OF A MODERN  
UNITED STATES REFINERY (18)

<u>Product</u>	<u>Percentage of Total Throughput</u>
Gasoline	44.4
Lube oil fraction	16.4
Jet fuel	6.2
Kerosine	2.9
Distillates	22.5
Residual fuel	7.6

Table V-22

## SULFUR CONTENT IN FRACTIONS OF KUWAIT CRUDE OIL (18)

<u>Fraction</u>	<u>Distillation Range (°F)</u>	<u>Total Sulfur (% by Weight)</u>
Crude Oil	--	2.55
Gasoline	124-253	0.05
Light naphtha	257-300	0.05
Heavy naphtha	307-387	0.11
Kerosene	405-460	0.45
Light gas oil	477-516	0.85
Heavy gas oil	538-583	1.15
Residual oil	588-928	3.70



the coke residue is inversely proportional to the square of its diameter, which, in turn, is related to the droplet diameter. Thus, small fuel droplets give rise to coke residues which burn very rapidly, and the ash-forming constituents are exposed to the highest temperatures in the flame envelope. The ash-forming droplets are heated more slowly, partly in association with carbon. Release of the ash from these residues is determined by the rate of oxidation of the carbon (18)

During combustion, the organic vanadium compounds in the residual fuel oil thermally decompose and oxidize in the gas stream to  $V_2O_3$ ,  $V_2O_4$  and finally  $V_2O_5$ . Although complete oxidation may not occur and there may be some dissociation, a large part of the vanadium originally present in the oil exists as vapor phase  $V_2O_5$  in the flue gas. The sodium, usually present as a chloride in the oil, vaporizes and reacts with sulfur oxides either in the gas stream or after deposition on tube surfaces. Subsequently, reactions take place between the vanadium and sodium compounds with the formation of complex vanadates which have melting points lower than those of the parent compounds. An example is shown in equation 9. The melting point of each compound is given below as well as the formula for the compound.

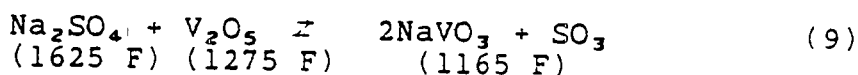

Excess vanadium or sodium in the ash deposit, above that necessary for the formation of the sodium vanadates (or vanadyl vanadates), may be present as  $V_2O_5$  and  $\text{Na}_2\text{SO}_4$ , respectively (18)

The sulfur in residual fuel is progressively released during combustion and is promptly oxidized to sulfur dioxide ( $\text{SO}_2$ ). A small amount of sulfur dioxide is further oxidized to  $\text{SO}_3$  by a small amount of atomic oxygen present in the hottest part of the flame. Also, catalytic oxidation of  $\text{SO}_2$  to  $\text{SO}_3$  may occur as the flue gases pass over vanadium rich ash deposits on high-temperature superheater tubes and refractories (18).

#### Characteristics of Fuel Oil Ash

With respect to fuel oil ash characteristics, sodium and vanadium are the most significant elements in fuel oil because they can form complex compounds having low melting temperatures, 480 to 1250 F, as shown in table V-23. Such temperatures fall within the range of tube-metal temperatures generally encountered in furnace and superheater tube banks of many oil-fired boilers. Because of its complex chemical composition, fuel-oil ash seldom has a single sharp melting point, but rather softens and melts over a wide temperature range (18). Oil ash (especially from plants using Venezuelan and certain Middle Eastern oil) can contain significant amounts of nickel.

Table V-23

## MELTING POINTS OF SOME OIL/ASH CONSTITUENTS (18)

<u>Compound</u>	<u>Melting Point (°F)</u>
Aluminum oxide, $Al_2O_3$	3720
Aluminum sulfate, $Al_2(SO_4)_3$	1420*
Calcium oxide, CaO	4662
Calcium sulfate, $CaSO_4$	2640
Ferric oxide, $Fe_2O_3$	2850
Ferric sulfate, $Fe_x(SO_4)_3$	895
Nickel oxide, NiO	3795
Nickel sulfate, $NiSO_4$	1545*
Silicon dioxide, $SiO_2$	3130
Sodium sulfate, $Na_2SO_4$	1625
Sodium bisulfate, $NaHSO_4$	480*
Sodium pyrosulfate, $Na_2S_2O_7$	750*
Sodium ferric sulfate, $Na_3Fe(SO_4)_3$	1000
Vanadium trioxide, $V_2O_3$	3580
Vanadium tetroxide, $V_2O_4$	3580
Vanadium pentoxide, $V_2O_5$	1275
Sodium metavanadate, $Na_2O.V_2O_5 (NaVO_3)$	1165
Sodium pyrovanadate, $2Na_2O.V_2O_5$	1185
Sodium orthovanadate, $3Na_2O.V_2O_5$	1560
Sodium vanadylvanadates, $Na_2O.V_2O_4.V_2O_5$	1160
$5Na_2O.V_2O_4.11V_2O_5$	995

---

\*Decomposes at a temperature around the melting point.

## Ash From Coal-Fired Plants

### Coal Ash Formation

More than 90 percent of the coal currently used by electric utilities is burned in pulverized coal boilers. In such boilers, 65 to 80 percent of the ash is produced in the form of fly ash, which is carried out of the combustor in the flue gases and is separated from these gases by electrostatic precipitators and/or mechanical collectors. The remainder of the ash drops to the bottom of the furnace as bottom ash or slag. The amounts of each type of ash produced in the United States during several recent years are listed in table V-24. The percentage of ash collected as fly ash has risen from 65 percent in 1971 to 71 percent in 1975.

The ash residue resulting from the combustion of coal is primarily derived from the inorganic matter in the coal. Table V-25 provides a breakdown of several of the major ash constituents for different ranks of coal. The overall percent ash in the coal varies from 3 to approximately 30 percent. These major ash components can vary widely in concentrations within a particular rank as well as between ranks. Relatively significant concentrations of trace elements are also found in the coal ash. Many of these elements are listed in table V-26 for various ranks of coal. These elements can range from a barely detectable limit to almost 14,000 ppm as the maximum measured for barium in some lignites and subbituminous coals.

During the combustion of coal, the products formed are partitioned into four categories: bottom ash, economizer ash, fly ash, and vapors. The bottom ash is that part of the residue which is fused into particles heavy enough to drop out of the furnace gas stream (air and combustion gases). These particles are collected in the bottom of the furnace. The economizer ash particles are sized approximately between those of bottom and fly ash. This ash is collected in economizer hoppers just beyond the boiler flue gas pass. The fly ash is that part of the ash which is entrained in the combustion gas leaving the boiler. While most of the fly ash is collected in mechanical collectors, baghouses, or electrostatic precipitators, a small quantity of this material may pass through the collectors and be discharged into the atmosphere. The vapor is that part of the coal material which is volatilized during combustion. Some of these vapors are discharged into the atmosphere; others are condensed onto the surface of fly ash particles and may be collected in one of the fly ash collectors. Certain of the trace elements are more volatile than others. The more volatile elements, e.g., mercury, fluorine, thallium, and antimony, will have a strong tendency to vaporize and perhaps condense on the fly ash particles. Some of the vapors may also be trapped inside larger sized bottom ash particles resulting in condensation there as well.

The distribution of the ash between the bottom ash and fly ash fractions is a function of the boiler type (firing method), the type of coal (ash fusion temperature), and the type of boiler bottom (wet

Table V-24

## MEGATONS OF COAL ASH COLLECTED IN THE UNITED STATES (19)

<u>Type</u>	<u>1971</u>	<u>1973</u>	<u>1974</u>	<u>1975</u>	<u>1980*</u>	<u>1985**</u>
Fly ash	27.7	34.6	40.4	42.3	-	-
Bottom ash	10.1	10.7	14.3	13.1	-	-
Boiler slag	5.0	4.0	4.8	4.6	-	-
	<u>42.8</u>	<u>49.3</u>	<u>59.5</u>	<u>60.0</u>	<u>75.0</u>	<u>120.0</u>
Coal consumed	-	-	390	403	-	-
Calculated average ash content	-	-	15.3%	14.9%	-	-

---

\*Projection by R. E. Morrison, American Electric Services Co.

\*\*Projection based on expected doubling in coal-fired power generation, 1975 to 1985.

Table V-25

## VARIATIONS IN COAL ASH COMPOSITION WITH RANK (19)

<u>Component</u>	<u>Rank</u>			
	<u>Anthracite</u>	<u>Bituminous</u>	<u>Subbituminous</u>	<u>Lignite</u>
SiO <sub>2</sub>	48-68	7-68	17-58	6-40
Al <sub>2</sub> O <sub>3</sub>	25-44	4-39	4-35	4-26
Fe <sub>2</sub> O <sub>3</sub>	2-10	2-44	3-19	1-34
TiO <sub>2</sub>	1-2	0.5-4	0.6-2	0-0.8
CaO	0.2-4	0.7-36	2.2-52	12.4-52
MgO	0.2-1	0.1-4	0.5-8	2.8-14
Na <sub>2</sub> O	-	0.2-3	-	0.2-28
K <sub>2</sub> O	-	0.2-4	-	0.1-1.3
SO <sub>3</sub>	0.1-1	0.1-35	3-16	8.3-32

Table V-26

RANGE IN AMOUNT OF TRACE ELEMENTS PRESENT IN COAL ASHES (19)  
(ppm)

<u>Element</u>	<u>Anthracites</u>			<u>High volatile bituminous</u>		
	<u>Max.</u>	<u>Min.</u>	<u>Average</u>	<u>Max.</u>	<u>Min.</u>	<u>Average</u>
Ag	1	1	*	3	1	*
B	130	63	90	2800	90	770
Ba	1340	540	866	4660	210	1253
Be	11	6	9	60	4	1253
Co	165	10	81	305	12	64
Cr	395	210	304	315	74	193
Cu	540	96	405	770	30	293
Ga	71	30	42	98	17	40
Ge	20	20	*	285	20	*
La	220	115	142	270	29	111
Mn	365	58	270	700	31	170
Ni	320	125	220	610	45	154
Pb	120	41	81	1500	32	183
Sc	82	50	61	78	7	32
Sn	4250	19	962	825	10	171
Sr	340	80	177	9600	170	1987
V	310	210	248	840	60	249
Y	120	70	106	285	29	102
Yb	12	5	8	15	3	10
Zn	350	155	*	1200	50	310
Zr	1200	370	688	1450	115	411

\* = Insufficient data to compute an average value.

= Figures encircled indicate the number of samples used to compute average values.

Table V-26 (Continued)

RANGE IN AMOUNT OF TRACE ELEMENTS PRESENT IN COAL ASHES (19)  
(ppm)

<u>Element</u>	<u>Low volatile bituminous</u>			<u>Medium volatile bituminous</u>		
	<u>Max.</u>	<u>Min.</u>	<u>Average</u>	<u>Max.</u>	<u>Min.</u>	<u>Average</u>
Ag	1.4	1	*	1	1	*
B	180	76	123	780	74	218
Ba	2700	96	740	1800	230	396
Be	40	6	16	31	4	13
Co	440	26	172	290	10	105
Cr	490	120	221	230	36	169
Cu	850	76	379	560	130	313
Ga	135	10	41	52	10	*
Ge	20	20	*	20	20	*
La	180	56	110	140	19	83
Mn	780	40	280	4400	125	1432
Ni	350	56		440	20	263
Pb	170	23	89	210	52	96
Sc	155	15	50	110	7	56
Sn	230	10	92	160	29	75
Sr	2500	66	818	1600	40	668
V	480	115	278	870	170	390
Y	460	37	152	340	37	151
Yb	23	4	10	13	4	9
Zn	550	62	231	460	50	195
Zr	620	220	458	540	180	326

\* = Insufficient data to compute an average value.

= Figures encircled indicate the number of samples used to compute average values.

Table V-26 (Continued)

RANGE IN AMOUNT OF TRACE ELEMENTS PRESENT IN COAL ASHES (19)  
(ppm)

<u>Lignites and Subbituminous</u>			
<u>Element</u>	<u>Max.</u>	<u>Min.</u>	<u>Average</u>
Ag	50	1	*
B	1900	320	1020
Ba	13900	550	5027
Be	28	1	6
Co	310	11	45
Cr	140	11	54
Cu	3020	58	655
Ga	30	10	23
Ge	100	20	*
La	90	34	62
Mn	1030	310	688
Ni	420	20	129
Pb	165	20	60
Sc	58	2	18
Sn	660	10	156
Sr	8000	230	4660
V	250	20	125
Y	120	21	51
Yb	10	2	4
Zn	320	50	*
Zr	490	100	245

\* = Insufficient data to compute an average value.

= Figures encircled indicate the number of samples used to compute average values.



or dry) The first factor, boiler type, is significant in determining ash distribution. The boiler types which are currently in use are pulverized coal, cyclone, and spreader stoker. Most modern boilers are the pulverized coal type. The different methods of firing pulverized-coal boilers are shown in figure V-11. Table V-27 shows the relative distributions of bottom ash and fly ash by boiler firing method. The smallest amount of fly ash, approximately 10 percent, is emitted by the cyclone furnace because the ash fusion temperature is exceeded and 80-85 percent of the ash is collected as slag in the bottom ash hopper.

A wet or dry bottom boiler influences the distribution of ash in pulverized coal-fired boilers. Most of the modern pulverized units utilize a dry bottom design. This type of furnace allows the ash to remain in a dry, or non-molten, state and drop through a grate into water-filled hoppers used to collect the ash. Ash in a dry state may reflect either a relatively low boiler design combustion temperature or the ash may contain constituents which are characterized by relatively high melting points. Since the dry ash does not fuse, it can be fairly easily entrained in the combustion gas stream resulting in higher fly ash/bottom ash ratios than in wet bottom boilers. The wet-bottom boiler collects bottom ash in a fused or molten state. This furnace is referred to as a slagging furnace. The relative distributions of bottom ash and fly ash by type of boiler bottom are also shown in table V-27.

#### Chemical Characteristics of Coal Ash

The chemical compositions of both types of bottom ash, dry or slag, are quite similar. The major species present in bottom ash are silica (20-60 weight percent as  $\text{SiO}_2$ ), alumina (10-35 weight percent as  $\text{Al}_2\text{O}_3$ ), ferric oxide (5-35 weight percent as  $\text{Fe}_2\text{O}_3$ ), calcium oxide (1-20 weight percent as  $\text{CaO}$ ), magnesium oxide (0.3-0.4 weight percent as  $\text{MgO}$ ), and minor amounts of sodium and potassium oxides (1-4 weight percent). In most instances, the combustion of coal produces more fly ash than bottom ash. Fly ash generally consists of very fine spherical particles, ranging in diameter from 0.5 to 500 microns. The major species present in fly ash are silica (30-50 weight percent as  $\text{SiO}_2$ ), alumina (20-30 weight percent as  $\text{Al}_2\text{O}_3$ ), and titanium dioxide (0.4-1.3 weight percent as  $\text{TiO}_2$ ). Other species which may be present include sulfur trioxide, carbon, boron, phosphorous, uranium, and thorium. Tables V-28 and V-29 provide some ranges for these major species. Species concentration differences between fly ash and bottom ash can vary considerably from one site to another.

In addition to these major components, a number of trace elements are also found in bottom ash and fly ash. Tables V-29 and V-30 present data concerning concentrations of these trace elements for both bottom and fly ash for various utility plants. The trace elemental concentrations can vary considerably within a particular ash or between ashes. Generally, higher trace element concentrations are found in the fly ash than bottom ash, however, there are several cases where bottom ash exceeds fly ash concentrations.

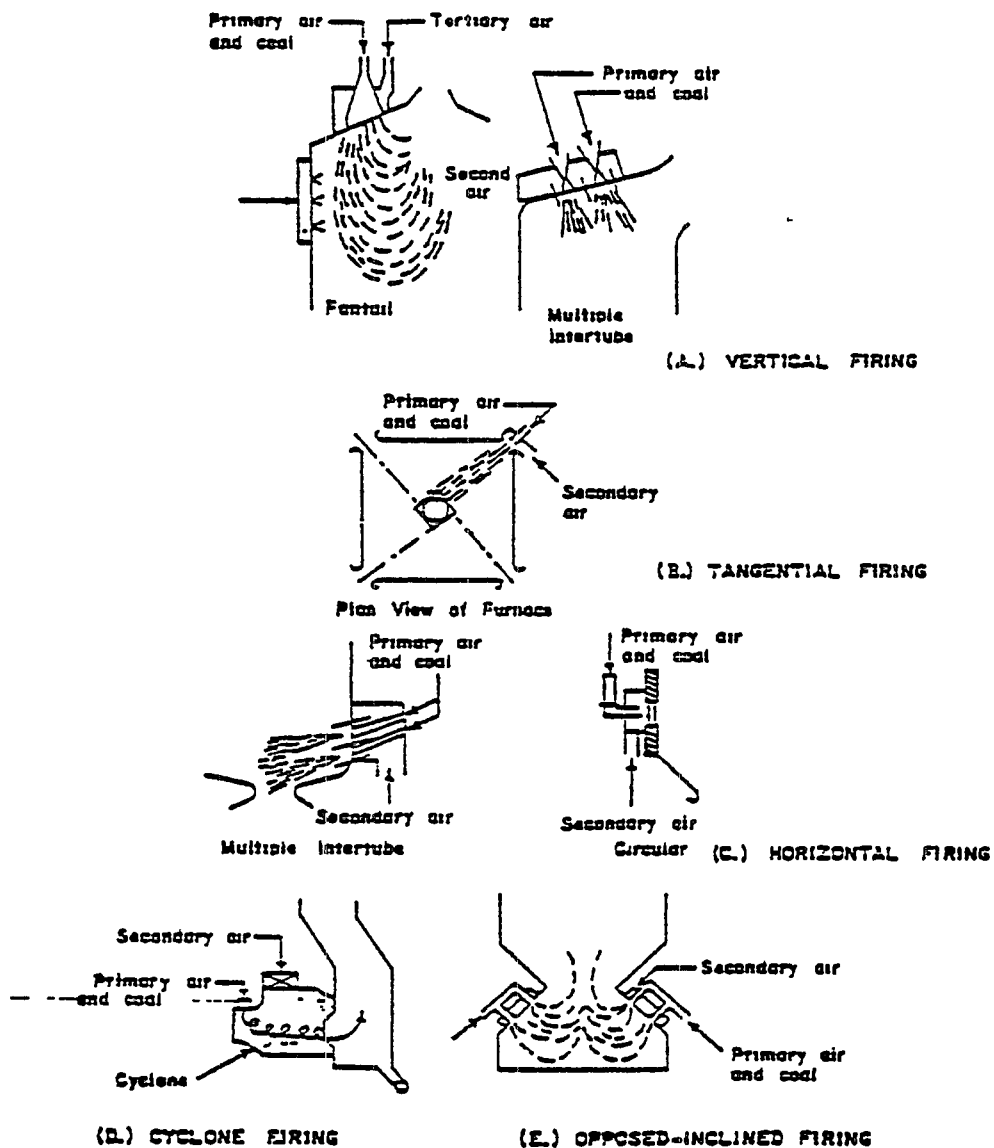

Figure V-11  
 PULVERIZED-COAL FIRING METHODS (19)

Table V-27

COMPARISON OF DISTRIBUTION BETWEEN BOTTOM ASH  
AND FLY ASH BY TYPE OF BOILERS AND METHOD OF FIRING (19)

<u>Type of Firing*</u>	<u>Type of Boiler Bottom**</u>	<u>% Bottom Ash (typical%)</u>	<u>% Fly Ash (typical%)</u>
PCFR	W	35	65
PCOP	W	35	65
PCTA	W	35	65
PCFR	D	15	85
PCOP	D	15	85
PCTA	D	15	85
CYCL	-	90	10
SPRE	-	35	65

---

\*PCFR - Pulverized coal front firing  
 PCOP - Pulverized coal opposed firing  
 PCTA - Pulverized coal tagential firing  
 CYCL - Cyclone  
 SPRE - Spreader stoker

\*\*W - wet bottom  
 D - dry bottom

Table V-28

MAJOR CHEMICAL CONSTITUENTS OF FLY ASH AND BOTTOM ASH  
FROM THE SOUTHWESTERN PENNSYLVANIA REGIONS (19)

<u>Constituent</u>	<u>Fly Ash (% by weight)</u>	<u>Bottom ash (% by weight)</u>
Sulfur trioxide	0.01-4.50	0.01-1.0
Phosphorus pentoxide	0.01-0.50	0.01-0.4
Silica	20.1-46.0	19.4-48.9
Iron oxide	7.6-32.9	11.7-40.0
Aluminum oxide	17.4-40.7	18.9-36.2
Calcium oxide	0.1-6.1	0.01-4.2
Magnesium oxide	0.4-1.2	0.5-0.9
Sodium oxide	0.3-0.8	0.2-0.8
Potassium oxide	1.2-2.4	1.7-2.8
Titanium oxide	1.3-2.0	1.3-1.8

Table V-29

## COMPARISON OF FLY ASH AND BOTTOM ASH FROM VARIOUS UTILITY PLANTS (19)

Compound or Element	Plant 1		Plant 2		Plant 3		Plant 4		Plant 5		Plant 6	
	FA	BA	FA	BA	FA	BA	FA	BA	BA	BA	BA	BA
SiO <sub>2</sub> , %	59	58	57	59	43	50	54	59	NR	NR	42	49
Al <sub>2</sub> O <sub>3</sub> , %	27	25	20	18.5	21	17	28	24	NR	NR	17	19
Fe <sub>2</sub> O <sub>3</sub> , %	3.8	4.0	5.8	9.0	5.6	5.5	3.4	3.3	20.4	30.4	17.3	16.0
CaO, %	3.8	4.3	5.7	4.8	17.0	13.0	3.7	3.5	3.2	4.9	3.5	6.4
SO <sub>3</sub> , %	0.4	0.3	0.8	0.3	1.7	0.5	0.4	0.1	NR	0.4	NR	NR
MgO, %	0.96	0.88	1.15	0.92	2.23	1.61	1.29	1.17	NR	NR	1.76	2.06
Na <sub>2</sub> O, %	1.88	1.77	1.61	1.01	0.4	0.5	1.5	1.5	NR	NR	1.36	0.67
K <sub>2</sub> O, %	0.9	0.8	1.1	1.0	1.44	0.64	0.38	0.43	NR	NR	2.4	1.9
P <sub>2</sub> O <sub>5</sub> , %	0.13	0.06	0.04	0.05	0.70	0.30	1.00	0.75	NR	NR	NR	NR
TiO <sub>2</sub> , %	0.43	0.62	1.17	0.67	1.17	0.50	0.83	0.50	NR	NR	1.00	0.68
As, ppm	12	1	8	1	15	3	6	2	8.4	5.8	110	18
Be, ppm	4.3	3	7	7	3	2	7	5	8.0	7.3	NR	NR
Cd, ppm	0.5	0.5	0.5	0.5	0.5	0.5	1.0	1.0	6.44	1.08	8.0	1.1
Cr, ppm	20	15	50	30	150	70	30	30	206	124	300	152
Cu, ppm	54	37	128	48	69	33	75	40	68	48	140	20
Mg, ppm	0.07	0.01	0.01	0.01	0.03	0.01	0.08	0.01	20.0	0.51	0.05	0.028

Table V-29 (Continued)

## COMPARISON OF FLY ASH AND BOTTOM ASH FROM VARIOUS UTILITY PLANTS (19)

Compound or Element	Plant 1		Plant 2		Plant 3		Plant 4		Plant 5		Plant 6	
	FA	BA	FA	BA	FA	BA	FA	BA	BA	BA	BA	BA
Mn, ppm	267	366	150	700	150	150	100	100	249	229	298	295
Ni, ppm	10	10	50	22	70	15	20	10	134	62	207	85
Pb, ppm	70	27	30	30	30	20	70	30	32	8.1	8.0	6.2
Se, ppm	6.9	0.2	7.9	0.7	18.0	1.0	12.0	1.0	26.5	5.6	25	0.08
V, ppm	90	70	150	85	150	70	100	70	341	353	440	260
Zn, ppm	63	24	50	30	71	27	103	45	352	150	740	100
B, ppm	266	143	200	125	300	70	700	300	NR	NR	NR	NR
Co, ppm	7	7	20	12	15	7	15	7	6.0	3.6	39	20.8
F, ppm	140	50	100	50	610	100	250	85	624	10.6	NR	NR

---

KEY    FA = Fly Ash  
        BA = Bottom Ash

Table V-30

CONCENTRATIONS OF SELECTED TRACE ELEMENTS  
IN COAL AND ASH AT PLANT 4710 (19)

Element	<u>Element Concentration</u>			
	<u>Coal</u> <sup>a</sup>	<u>Bottom ash</u>	<u>Inlet fly ash</u> <sup>b</sup>	<u>Outlet fly ash</u> <sup>c</sup>
As	4.45	18	110	440
Ba	65	500	465	750
Br	3.7	2	4	
Cd	0.47	1.1	8.0	51
Ce	8.2	84	84	120
Cl	914	<100	<200	
Co	2.9	20.8	39	65
Cr	18	152	300	900
Cs	1.1	7.7	13	27
Cu	8.3	20	140	
Eu	0.1	1.1	1.3	1.3
Ga	4.5	5	81	
Hf	0.4	4.6	4.1	5.0
Hg	0.122	0.028	0.050	
La	3.8	42	40	42
Mn	33.8	295	298	430
Ni	16	85	207	
Pb	4.9	6.2	80	650
Rb	15.5	102	155	55
Sb	0.5	0.64	12	36
Sc	2.2	20.8	26	88
Se	2.2	0.08	25	36
Sm	1.0	8.2	10.5	9
Sr	23	170	250	
Ta	0.11	0.95	1.4	1.8
Tn	2.1	15	20	26
U	2.18	14.9	30.1	
V	28.5	260	440	1180
Zn	46	100	740	5900

<sup>a</sup>Mixture of coals from southern Illinois and western Kentucky.  
Ash content 12%.

<sup>b</sup>Collected upstream from electrostatic precipitator.

<sup>c</sup>Collected downstream from electrostatic precipitator.

Figure V-12 presents the size distribution curves for fly ash and bottom ash. The difference between the 50 percent grain sizes of bottom ash and fly ash is approximately two orders of magnitude with bottom ash being the larger. Fly ash demonstrates various concentrations of trace elements in various size ranges of particles. More specifically, there exists an increased concentration trend with decreasing particle sizes as shown in table V-31.

Those data on the composition of ash particles demonstrate that priority pollutants are present in the dry ashes and therefore can dissolve into water when ash sluicing methods are used. The next section addresses observed concentrations of these materials in ash handling waters. The purpose is to assess the extent to which these materials enter the ash sluicing waters and therefore are discharged from the plants.

### Characterization of Ash Pond Overflows

#### Data From EPA Regional Offices

Table V-32 is a compilation of data obtained for ash pond overflows from various EPA regional offices. These data summarize ash pond effluents where the total suspended solids values are less than 30 ppm. This data was studied to determine whether a correlation existed between TSS values and the corresponding heavy metal concentrations (20). The results from this study of five different metals, i.e., arsenic, nickel, zinc, copper, and selenium, indicated that no correlation existed between these concentrations and TSS values. Additional data on ash pond overflow are available in the 1974 Development Document (1).

Discharge monitoring report data for 17 plants from various EPA regional offices have been summarized. Table V-33 lists metals concentrations for fly ash ponds, bottom ash ponds, and combined pond systems. These metal concentrations are discharge values only; they do not reflect a net discharge based on intake water metals concentrations.

#### Tennessee Valley Authority Data

Combined Ash Ponds. In 1973, the Tennessee Valley Authority (TVA) began collecting ash pond effluents and water intake samples quarterly for trace metals; calcium, chloride, and silica analyses. A summary of these data for 1973 through 1975 for plants with combined fly ash and bottom ash ponds appears in table V-34. The complete data from which the summary tables were prepared is presented in Appendix A. The summary consists of the average, maximum, and minimum concentrations for each element. The average was calculated by substituting a value equal to the minimum quantifiable concentration (MQC) when the reported value was less than the MQC. Thus, the average may be biased upward if there is a significant number of values less than the MQC. Those elements most likely affected are As, Ba, Be, Cd, Cr, Pb, Hg, Ni, and Se.



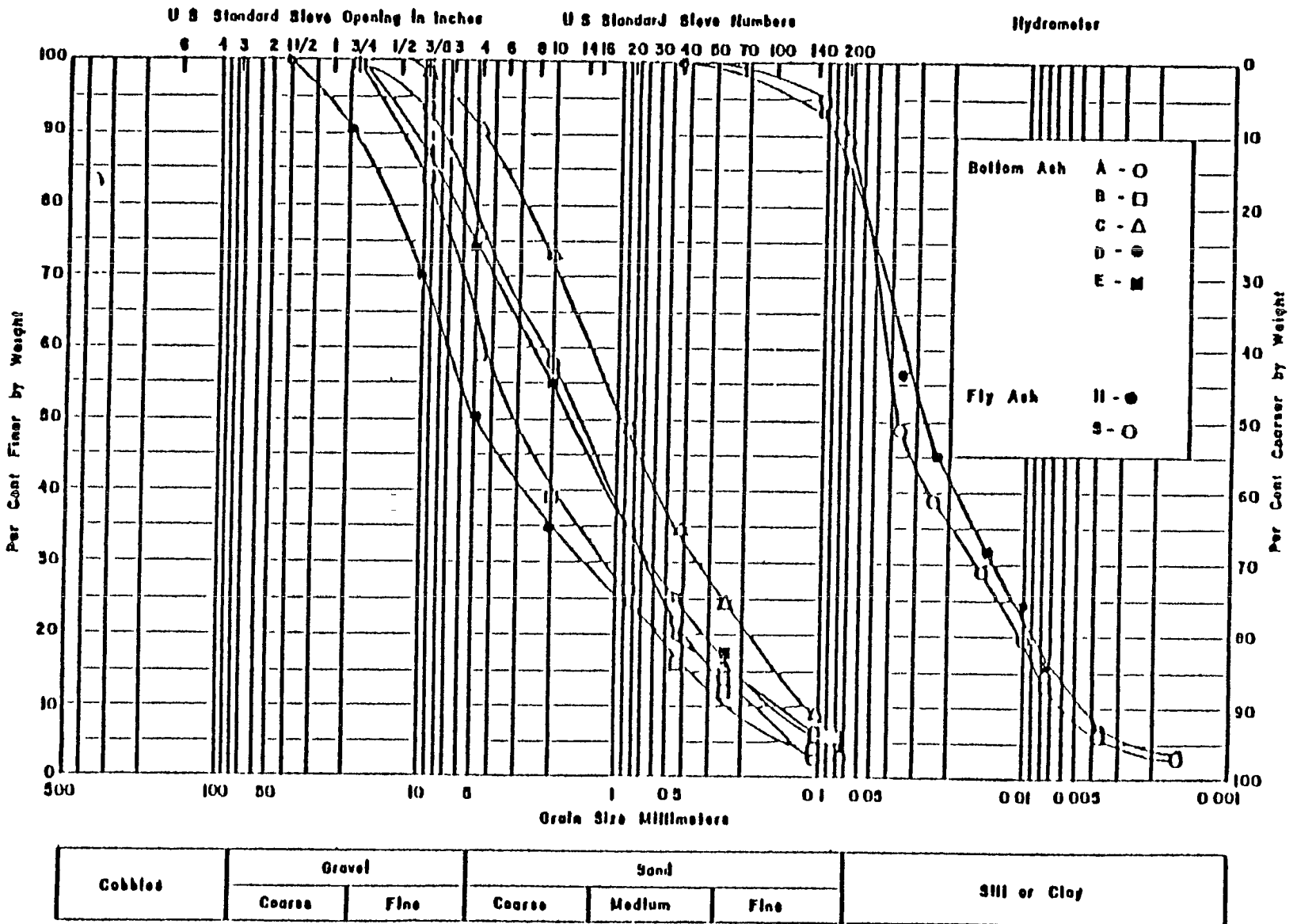

Figure V-12  
GRAIN SIZE DISTRIBUTION CURVES FOR BOTTOM ASH AND FLY ASH (19)

Table V-31

ELEMENTS SHOWING PRONOUNCED CONCENTRATION TRENDS  
WITH DECREASING PARTICLE SIZE (19)

(ppm unless otherwise noted)

Particle Diameter (mm)	<u>Pb</u>	<u>Tl</u>	<u>Sb</u>	<u>Cd</u>	<u>Se</u>	<u>As</u>	<u>Ni</u>	<u>Cr</u>	<u>Zn</u>
A. Fly Ash Retained in Plant									
1. Sieved fractions									
74	140	7	1.5	10	12	180	100	100	500
44-74	160	9	7	10	20	500	140	90	411
2. Aerodynamically sized fractions									
40	90	5	8	10	15	120	300	70	730
30-40	300	5	9	10	15	160	130	140	570
20-30	430	9	8	10	15	200	160	150	480
15-20	520	12	19	10	30	300	200	170	720
10-15	430	15	12	10	30	400	210	170	770
5-10	820	20	25	10	50	800	230	160	1100
5	980	45	31	10	50	370	260	130	1400
3. Analytical method*									
	a	a	a	a	a	a	a	b	a
B. Airborne Fly Ash									
1. Data									
11.3	1100	29	17	13	13	680	460	740	8100
7.3-11.3	1200	40	27	15	11	800	400	290	9000
4.7-7.3	1500	62	34	18	16	1000	440	460	6600
3.3-4.7	1550	67	34	22	16	900	540	470	3800
2.1-3.3	1500	65	37	26	19	1200	900	1500	15000
1.1-2.1	1600	76	53	35	59	1700	1600	3300	13000
0.65-1.1	...	..	..	..	..	..	..	..	..
2. Analytical method*									
	d	a	a	d	d	d	d	d	a

- 
- \* - (a) DC arc emission spectrometry.  
 (b) Atomic absorption spectrometry.  
 (c) X-ray fluorescence spectrometry.  
 (d) Spark source mass spectrometry.

Table V-32

CHARACTERISTICS OF ASH POND OVERFLOWS WITH TOTAL  
 SUSPENDED SOLIDS CONCENTRATIONS LESS THAN 30 mg/l (19)  
 (mg/l)

Plant Code	Capacity (MW)	Fuel*	No of Samples	SS	Fe	Cu	Cd	Ni	A	Pb	Hg	Zn	Se	P	Cr	Oil & Grease
3711	781	c/o	18	24.5	0.36	0.1	0.02	0.1	0.06	0.1	0.002	0.14	0.007	-	0.05	0.23
3708	466	c/o	6	14.7	0.12	0.1	0.02	0.1	0.14	0.1	0.003	0.01	0.005	-	0.05	0.16
4234	598	c/o	1	6.0	0.38	0.01	-	0.0	0.011	0.05	-	0.03	-	-	-	1.71
0512	1,341	c	7	16.5	0.63	0.01	-	0.01	0.19	0.14	0.001	0.04	0.011	-	0.01	4.0
1226	1,229	c/g	22	9.4	0.92	0.03	-	-	0.02	0.01	0.0006	0.05	-	0.10	0.01	1.2
3713	2,000	c/o	9	5.2	0.20	0.1	0.2	0.1	0.03	0.1	0.002	0.08	0.03	-	0.05	0.17
3701	421	c/o	3	18.0	0.47	0.05	0.01	0.05	0.01	0.05	0.001	0.05	0.10	-	0.05	1.0
2105	511	c	5	4.4	0.11	0.006	0.00004	0.02	0.004	0.0005	0.0005	0.004	-	0.004	1.3	
2102	132	c/o	2	10.9	0.2	0.009	-	0.0045	0.03	0.04	0.0004	0.06	0.018	-	0.003	0.26
3805	660	c	1	15	-	0.11	0.002	-	0.06	0.01	0.0001	0.04	-	-	0.02	-
2103	694	c	3	20	0.52	0.15	-	0.005	0.21	0.007	0.0001	0.02	0.01	-	0.005	0.79

\* c - coal  
 o - oil  
 g - gas

Table V-33

SUMMARY OF ASH POND OVERFLOW DATA FROM  
DISCHARGE MONITORING REPORTS (21)

(ppb)

<u>Trace Metal</u>	<u>Fly Ash Ponds<sup>1</sup></u>			<u>Bottom Ash Ponds<sup>2</sup></u>			<u>Combined Ponds<sup>3</sup></u>		
	Min.	Max.	Ave.	Min.	Max.	Ave.	Min.	Max.	Ave.
As	10	66	29.2	7	70	21.1	3.5	416	67
Cd	3.5	26.9	11.8	2	16.3	9.7	0	82	18.7
Cr	5	15.2	10.2	4	41.7	15.6	2.5	84.2	30.4
Cu	20	209	84.8	5	70	36.9	0	130	59
Fe	1055	8138	4011	657	10950	3410	80	2600	664.6
Pb	10	200	59.4	10	60	25.5	0	100	40.1
Hg	0.1	1.8	0.6	0.4	1.7	0.8	0	65	3.9
Ni	33	100	61.1	13.3	1345	191.4	0	100	49
Se	2	7.8	4.4	2	10	6.7	1.7	68.3	23.6
Zn	50	1139	358.4	10	302	131.9	10	293	94.9

---

<sup>1</sup>Data for 4 facilities<sup>2</sup>Data for 9 facilities<sup>3</sup>Data for 20 facilities

Table V-34

SUMMARY OF QUARTERLY TVA TRACE METAL DATA FOR ASH POND INTAKE  
AND EFFLUENT STREAMS (22)

		Plant C			Plant C			Plant D			Plant E		
		Minimum	Average	Maximum	Minimum	Average	Maximum	Minimum	Average	Maximum	Minimum	Average	Maximum
Aluminum	EFF	0.3	1.5	3.8	0.5	3.4	8	<0.2	1.4	3.8	1.1	2.5	3.4
	RW	0.6	4.7	15	1.3	5.2	15	0.2	0.5	0.9	1.7	2.9	4.3
Ammonia as N	EFF	0.02	0.11	0.34	<0.02	0.09	0.22	<0.01	0.06	0.15	0.03	0.06	0.09
	RW	0.03	0.14	0.33	0.03	0.16	0.29	<0.01	0.04	0.13	0.04	0.07	0.10
Arsenic	EFF	<0.005	0.013	0.05	<0.005	0.022	0.035	<0.005	0.034	0.100	<0.005	0.028	0.13
	RW	<0.005	0.008	0.026	<0.005	0.009	0.026	<0.005	<0.005	<0.005	<0.005	<0.005	<0.005
Barium	EFF	<0.1	0.2	0.4	<0.1	0.14	0.3	<0.1	0.2	0.3	<0.1	0.2	0.4
	RW	<0.1	0.1	0.2	<0.1	0.14	0.2	<0.1	0.1	0.2	<0.1	0.2	0.4
Beryllium	EFF	<0.01	<0.01	<0.01	<0.01	<0.01	<0.01	<0.01	<0.01	<0.01	<0.01	<0.01	<0.01
	RW	<0.01	<0.01	<0.01	<0.01	<0.01	<0.01	<0.01	<0.01	<0.01	<0.01	<0.01	<0.01
Cadmium	EFF	0.002	0.006	0.013	<0.001	0.002	0.010	<0.001	0.001	0.002	<0.001	0.001	0.002
	RW	<0.001	0.001	0.002	<0.001	0.001	0.002	<0.001	<0.001	<0.001	<0.001	0.001	0.002
Calcium	EFF	45	78	100	19	37	89	26	31	37	68	126	170
	RW	15	29	45	15	33	43	23	28	31	14	17	20
Chloride	EFF	7	11	16	7	11	16	2	3	5	5	6	2
	RW	7	11	16	7	11	16	2	3	4	4	5	6
Chromium	EFF	<0.005	0.006	0.008	<0.005	0.009	0.024	<0.005	<0.005	0.008	<0.005	0.017	0.025
	RW	<0.005	0.012	0.041	<0.005	0.013	0.041	<0.005	0.005	<0.005	<0.005	<0.005	<0.005
Copper	EFF	<0.01	0.05	0.10	<0.01	0.06	0.18	<0.01	0.03	0.14	0.02	0.08	0.19
	RW	0.03	0.11	0.22	0.03	0.12	0.22	0.02	0.07	0.22	0.02	0.05	0.08
Cyanide	EFF	<0.01	0.01	<0.01	<0.01	0.01	0.01	<0.01	<0.01	<0.01	<0.01	<0.01	<0.01
	RW	-	-	-	-	-	-	-	-	-	-	-	-
Iron	EFF	0.33	1.7	4.1	0.72	6.0	27	<0.05	0.32	0.67	0.05	0.16	0.39
	RW	1.0	6.5	14	1.4	7.2	14	0.25	0.51	1.00	0.45	1.0	1.6
Lead	EFF	<0.010	0.021	0.069	<0.010	0.017	0.033	<0.010	0.016	0.046	<0.01	0.017	0.036
	RW	<0.010	0.022	0.047	<0.010	0.024	0.047	<0.010	0.012	0.018	<0.01	0.015	0.028
Magnesium	EFF	1.4	10	16	6.3	10	16	7.5	8.3	9.8	0.1	0.3	0.3
	RW	6.5	9.5	14	6.5	6.6	14	7.1	8.0	9.1	3.0	3.4	4.1
Manganese	EFF	0.13	0.20	0.34	0.05	0.18	0.16	<0.01	0.02	0.05	<0.01	0.01	0.02
	RW	0.12	0.31	0.53	0.12	0.31	0.53	0.03	0.07	0.13	0.04	0.05	0.07
Mercury	EFF	<0.0002	0.0034	0.0074	<0.0002	0.0070	0.050	<0.0002	0.0002	0.0003	<0.0002	0.0002	0.0001
	RW	<0.0002	0.0004	0.0016	<0.0002	0.0003	0.0016	<0.0002	0.0002	0.0005	<0.0002	<0.0002	<0.0001
Nickel	EFF	<0.05	0.05	0.07	<0.05	0.06	0.17	<0.05	0.06	0.19	<0.05	<0.05	<0.05
	RW	<0.05	<0.05	<0.05	<0.05	0.05	0.05	<0.05	0.08	0.27	<0.05	<0.05	<0.05

Table V-34 (Continued)

SUMMARY OF QUARTERLY TVA TRACE METAL DATA FOR ASH POND INTAKE  
AND EFFLUENT STREAMS (22)

		Plant C			Plant C			Plant D			Plant E		
		Minimum	Average	Maximum	Minimum	Average	Maximum	Minimum	Average	Maximum	Minimum	Average	Maximum
Selenium	EFF RW	<0 001 <0 001	0 010 0 002	0.080 0 004	<0 001 <0 002	0 003 0 002	0 004 0 004	<0 002 <0 002	0 070 0 002	0 170 0 004	<0 002 <0 002	0 007 <0 002	0 014 <0 002
Silica	EFF RW	4 7 5.5	7 4 6 1	11 7 9	1 5 5 4	6 7 6 2	14 7 9	3 2 3 8	4 0 5 2	6 2 9 5	5 9 4 5	7 0 4 7	8 4 5 0
Silver	EFF RW	<0 01 <0.01	0 01 0 01	0 03 <0 01	<0 01 <0 01	0 01 0 01	0 02 <0 01	<0 01 <0 01	0 01 <0 01	0 01 <0 01	<0 01 <0 01	0 01 <0 01	0 02 <0 01
Dissolved Solids	EFF RW	260 160	345 205	460 240	170 160	239 197	420 220	100 110	156 126	200 140	240 80	368 93	420 100
Suspended Solids	EFF RW	3 11	18 46	37 150	4 17	31 51	98 150	3 1	15 14	45 55	2 8	4 18	6 38
Sulfate	EFF RW	110 0 07	158 23	200 52	35 34	99 49	280 68	16 13	57 16	84 20	100 15	147 20	210 25
Zinc	EFF RW	0 02 0 03	0 13 0 08	0 27 0 13	0 03 0 03	0 14 0 08	0 16 0 13	<0 01 0 03	0 03 0 04	0 07 0 07	<0 03 0 04	0 05 0 08	0 07 0 18

		Plant F			Plant G			Plant J			Plant I South		
		Minimum	Average	Maximum	Minimum	Average	Maximum	Minimum	Average	Maximum	Minimum	Average	Maximum
Aluminum	EFF RW	0 8 <0 1	1.7 1 4	3 1 3 6	0 4 0.1	1 7 1 2	2 9 4 1	0 8 <0 2	1 6 1 0	2 9 1 6	0 6 0 8	1 5 1 6	2 6 3 0
Ammonia as N	EFF RW	0 03 0 02	0 17 0 08	42 0 26	<0 01 0 01	0 12 0 04	0 62 0 08	0 03 0 06	0 34 0 23	2 60 0 49	0 01 0 08	0 07 0 05	0 31 0 10
Arsenic	EFF RW	<0 005 <0 005	0 008 <0 005	0 040 <0 005	<0.005 <0 005	0 030 <0 005	0 070 <0 005	<0 005 <0 005	0 123 0 006	0 360 0 010	<0 005 <0 005	0 036 <0 005	0 163 <0 005
Barium	EFF RW	<0 1 <0 1	0 2 0 1	0 3 0 1	<0 1 <0 1	0 2 0 1	0 4 0 1	<0 1 <0 1	0 2 0 1	0 3 0 2	<0 1 0 1	0 2 0 2	0 5 0 3
Beryllium	EFF RW	<0 01 <0 01	<0 01 <0 01	<0 01 <0 01	<0 01 <0 01	<0 01 <0 01	<0 01 <0 01	<0 01 <0 01	<0 01 <0 01	<0 01 <0 01	<0 01 <0 01	<0 01 <0 01	<0 01 <0 01
Cadmium	EFF RW	<0 001 <0 001	0 001 0 001	0 002 0 002	<0 001 <0 001	<0 001 <0 001	<0 001 <0 001	<0 001 <0 001	0 001 <0 001	0 002 <0 001	<0 001 <0 001	<0 001 <0 001	<0 001 <0 001
Calcium	EFF RW	67 19	107 27	160 35	38 13	73 20	110 25	34 22	50 28	67 35	44 17	94 19	130 21
Chloride	EFF RW	4 3	5 4	6 4	2 3	4 4	8 5	8 7	14 14	22 28	4 4	6 6	12 8

Table V-34 (Continued)

SUMMARY OF QUARTERLY TVA TRACE METAL DATA FOR ASH POND INTAKE  
AND EFFLUENT STREAMS (22)

		Plant F			Plant G			Plant H			Plant I South		
		Minimum	Average	Maximum	Minimum	Average	Maximum	Minimum	Average	Maximum	Minimum	Average	Maximum
Chromium	EFF	<0 005	0 033	0 072	<0 005	0 011	0 023	<0 005	0 006	0 01	<0 005	0 017	0 030
	RW	<0 005	0 006	0 012	<0 005	0 005	0 010	<0 005	0 005	0 007	<0 005	<0 005	<0 005
Copper	EFF	<0 01	0 03	0 08	<0 01	0 05	0 12	<0 01	0 04	0 14	<0 01	0 06	0 15
	RW	<0 01	0 05	0 08	<0 01	0 07	0 16	0 02	0 07	0 15	0 01	0 07	0 12
Cyanide	EFF	<0 01	<0 01	<0 01	<0 01	0 01	0 02	<0 01	<0 01	<0 01	<0 01	<0 01	<0 01
	RW	-	-	-	-	-	-	-	-	-	-	-	-
Iron	EFF	<0 05	0 22	1 1	0 26	0 53	1 4	0 18	0 56	1 4	<0 05	0 26	0 58
	RW	0 10	1 1	2 1	0 33	1 3	4 6	0 45	1 1	1 7	0 61	1 7	3 5
Lead	EFF	<0 010	0 013	0 040	<0 010	0 014	0 036	0 010	0 015	0 036	<0 01	0 012	0 038
	RW	<0 010	0 019	0 052	<0 010	0 019	0 04	0 010	0 019	0 033	0 01	0 15	0 221
Magnesium	EFF	0 3	1 57	7 2	1 1	2 4	3 1	6 2	7 4	9 7	0 2	1 2	3 7
	RW	3 5	4 2	4 9	3 4	4 0	4 6	5 7	7 4	13 0	2 6	3 3	4 3
Manganese	EFF	<0 01	0 01	0 04	<0 01	0 02	0 04	0 02	0 06	0 10	<0 01	0 05	0 3
	RW	0 06	0 07	0 011	0 05	0 10	0 23	0 10	0 14	0 18	0 01	0 01	0 2
Mercury	EFF	<0 0002	0 0003	0 0009	<0 0002	0 0024	0 014	<0 0002	0 0004	0 0016	<0 0002	0 0003	0 0032
	RW	<0 0002	0 0006	0 0033	<0 0002	0 0049	0 0031	<0 0002	0 0003	0 0008	<0 0002	0 0002	0 0003
Nickel	EFF	<0 05	0 05	<0 05	<0 05	<0 05	<0 05	<0 05	0 05	0 07	<0 05	0 05	0 05
	RW	<0 05	<0 05	<0 05	<0 05	<0 05	<0 05	<0 05	<0 05	<0 05	<0 05	<0 05	<0 05
Selenium	EFF	0 006	0 014	0 028	<0 001	0 010	0 019	<0 002	0 017	0 034	<0 002	0 012	0 08
	RW	<0 002	<0 002	<0 002	<0 001	0 002	0 004	<0 001	0 002	0 006	<0 001	<0 002	<0 002
Silica	EFF	3 9	6 0	7 6	3 4	4 4	7 1	2 7	4 9	5 6	6 0	7 1	9 1
	RW	3 5	4 5	5 4	3 5	4 4	5 4	2 7	4 9	6 6	3 2	5 4	6 4
Silver	EFF	<0 01	<0 01	<0 01	<0 01	<0 01	<0 01	<0 01	<0 01	<0 01	<0 01	<0 01	<0 01
	RW	<0 01	<0 01	<0 01	<0 01	<0 01	<0 01	<0 01	<0 01	<0 01	<0 01	<0 01	<0 01
Dissolved Solids	EFF	230	366	540	190	266	320	200	256	350	190	248	370
	RW	90	129	170	70	144	480	110	145	180	90	121	310
Suspended Solids	EFF	<1	4	20	8	19	45	4	10	19	<1	5	15
	RW	6	26	42	5	18	67	10	24	29	4	24	57
Sulfate	EFF	14	160	260	88	182	620	45	98	150	50	81	200
	RW	12	19	23	<1	17	23	16	19	22	10	21	80
Zinc	EFF	<0 01	0 05	0 14	<0 01	0 05	0 10	<0 01	0 05	0 15	<0 01	0 08	0 24
	RW	0 03	0 12	0 22	0 03	0 09	0 13	0 04	0 11	0 33	0 03	0 07	0 12

Table V-34 (Continued)

SUMMARY OF QUARTERLY TVA TRACE METAL DATA FOR ASH POND INTAKE  
AND EFFLUENT STREAMS (22)

		Minimum	Plant J Average	Maximum	Minimum	Plant K Average	Maximum	Minimum	Plant L Average	Maximum
Aluminum	EFF	0.4	2.6	7.6	0.5	1.8	3.1	1.3	2.0	2.6
	RW	0.3	0.7	1.4	0.6	2.0	3.4	0.3	1.2	2.8
Ammonia as N	EFF	0.01	0.05	0.08	0.02	0.06	0.16	0.06	0.52	0.40
	RW	0.01	0.04	0.23	0.04	0.09	0.24	0.04	0.06	0.08
Arsenic	EFF	0.005	0.041	0.130	0.005	0.033	0.100	<0.005	0.032	0.070
	RW	0.005	0.018	0.110	0.005	0.009	0.024	<0.005	0.006	0.010
Barium	EFF	<0.1	0.2	0.3	<0.1	0.2	0.3	<0.1	0.1	0.2
	RW	<0.1	0.2	0.4	<0.1	0.1	0.3	<0.1	0.1	0.2
Beryllium	EFF	<0.01	<0.01	<0.01	<0.01	<0.01	<0.01	<0.01	<0.01	<0.01
	RW	<0.01	<0.01	<0.01	<0.01	<0.01	<0.01	<0.01	<0.01	<0.01
Cadmium	EFF	<0.001	0.001	0.002	<0.001	0.001	0.002	<0.001	0.001	0.004
	RW	<0.001	0.001	0.002	<0.001	<0.001	<0.001	<0.001	<0.001	<0.001
Calcium	EFF	20	34	57	44	76	130	32	54	91
	RW	4	15	30	12	20	28	13	17	21
Chloride	EFF	2	5	21	6	10	19	4	6	9
	RW	2	2	4	4	7	10	4	6	8
Chromium	EFF	<0.005	0.005	0.007	<0.005	0.019	0.036	<0.005	0.009	0.018
	RW	<0.005	0.005	0.006	<0.005	0.009	0.027	<0.005	0.009	0.021
Copper	EFF	0.02	0.11	0.73	0.01	0.05	0.10	<0.01	0.06	0.14
	RW	<0.01	0.08	0.13	<0.01	0.07	0.12	<0.01	0.07	0.14
Cyanide	EFF	<0.01	<0.01	<0.01	<0.01	<0.01	<0.01	<0.01	<0.01	<0.01
	RW	-	-	-	-	-	-	-	-	-
Iron	EFF	0.1	2.4	9.4	0.11	0.39	1.2	0.05	0.56	1.00
	RW	0.26	0.7	1.2	0.66	1.9	3.3	0.28	1.03	2.40
Lead	EFF	<0.010	0.015	0.038	0.010	0.017	0.048	0.010	0.017	0.043
	RW	<0.010	0.010	0.018	0.01	0.01	0.03	0.010	0.016	0.032
Magnesium	EFF	3.9	6.7	9.3	0.4	1.6	3.6	0.4	2.6	4.2
	RW	1.2	4.5	8.3	2.5	4.3	6.9	3.4	3.9	4.4
Manganese	EFF	0.05	0.38	0.79	0.01	0.02	0.04	0.01	0.03	0.13
	RW	0.03	0.07	0.18	0.07	0.10	0.18	0.03	0.07	0.12
Mercury	EFF	<0.0002	0.0003	0.0008	<0.0002	0.0003	0.0008	0.0002	0.0003	0.0009
	RW	<0.0002	0.0003	0.0009	<0.0002	<0.0002	<0.0002	<0.0002	<0.0002	<0.0002
Nickel	EFF	<0.05	0.05	0.08	<0.05	0.06	0.22	<0.05	<0.05	<0.05
	RW	<0.05	<0.05	<0.05	<0.05	<0.05	<0.05	<0.05	<0.05	<0.05



Table V-34 (Continued)

SUMMARY OF QUARTERLY TVA TRACE METAL DATA FOR ASH POND INTAKE  
AND EFFLUENT STREAMS (22)

		Plant J			Plant K			Plant L		
		Minimum	Average	Maximum	Minimum	Average	Maximum	Minimum	Average	Maximum
Selenium	EFF	<0 001	0 004	0 008	<0 002	0.010	0 016	0 002	0 010	0 020
	RW	<0 001	0 003	0 008	<0 001	0 002	0 002	<0 001	0 002	0 002
Silica	EFF	3 5	6 4	8 7	4 0	6 7	8 8	4 5	5 7	9 1
	RW	1 0	3 9	5 0	2 5	4 6	5 9	3 6	5 1	5 8
Silver	EFF	<0 01	<0 01	<0 01	<0 01	<0 01	<0 01	<0 01	<0 01	<0 01
	RW	<0 01	<0 01	<0 01	<0 01	<0 01	<0 01	<0 01	<0 01	<0 01
Dissolved Solids	EFF	140	202	250	180	240	310	140	211	260
	RW	30	89	210	80	106	150	70	88	100
Suspended Solids	EFF	1	15	81	3	8	26	3	12	50
	RW	5	13	35	17	29	60	4	14	43
Sulfate	EFF	56	119	180	54	83	110	6	80	110
	RW	9	22	80	12	20	31	9	13	16
Zinc	EFF	0 02	0 07	0 25	0 01	0 05	0 11	0 02	0 04	0 06
	RW	0 03	0 06	0 09	0 04	0 07	0 11	0 03	0 06	0 09

NOTE Effluent data based on years 1973-1975  
Raw water intake data based on years 1974 and 1975

KEY EFF - effluent  
RW - raw water (intakes)

The average concentrations of calcium, chloride, iron, magnesium, and manganese varied considerably from one effluent to another, while the average concentrations of aluminum, arsenic, silica, and sulfate varied only slightly. The average concentrations of barium, cadmium, chromium, copper, lead, mercury, nickel, selenium, and zinc were approximately the same in all the ash pond effluents. The combined ash pond effluent at Plant D had a considerably higher concentration of selenium (70 ppb) than the rest of the effluents, while the ash pond effluent from Plant H had a considerably higher concentration of arsenic (123 ppb) than the others. The plants, other than Plant H, had less than 50 ppb arsenic in the effluents.

TVA statistically compared the intake water characteristics to those of the effluents for Plants E, G, H, and J. Of particular importance was the evaluation of a potential relationship between priority pollutants (metals) and suspended solids. Essentially no correlation existed between suspended solids in the ash pond effluent and intake water quality characteristics.

Relationships between the ash pond effluent and the plant operating conditions were also studied by TVA. Table V-35 provides a summary of the TVA plant operating conditions during collection of the ash pond effluent data. No bottom ash characteristic data were available for this study. Statistical correlations of the data show the pH of the ash pond effluent is influenced mainly by the calcium content of the fly ash and by the sulfur content of the coal. As the percent CaO goes up, the alkalinity of the ash pond effluent increases. The number of ash ponds in which the average concentration of each trace element shows a net increase from the ash pond influent to the overflow is presented in table V-36. More than half of the ash ponds increase the concentrations of Al, NH<sub>3</sub>, As, Ba, Cd, Ca, Cl, Cr, Pb, Hg, Ni, Se, Si, SO<sub>4</sub>, and Zn over that of the intake water. According to studies completed by TVA (22), the range over which the trace metals vary in the ash pond effluent appeared to be as great or greater than that in the intake water.

Separate Bottom Ash and Fly Ash Ponds Certain utilities utilize separate fly ash and bottom ash ponds for handling the sluice water in their ash pond effluent systems. Table V-37 provides both ash pond effluent and raw water trace element and solids data for the separate fly ash and bottom ash ponds for two TVA plants. The complete data from which the summary table was prepared is presented in Appendix A. Most of the elements appeared in greater concentrations in the fly ash effluent than in the bottom ash effluent for Plant A. On the average, the concentrations observed in Plant A fly ash effluents are at least several times as great as the observed bottom ash concentrations. For Plant B, the fly ash and bottom ash effluent concentrations are approximately equal. Comparison of ash effluent concentrations to the raw water concentrations for Plant A reveals that the bottom ash concentrations are approximately equal to the raw water concentrations. The Plant A fly ash concentrations generally exceed the raw water concentrations. For Plant B, the bottom ash and fly ash effluent concentrations generally exceed the raw water

Table V-35

SUMMARY OF PLANT OPERATION CONDITIONS AND ASH CHARACTERISTICS  
OF TVA COAL-FIRED POWER PLANTS (22)

Parameters	Plant C	Plant D	Plant E	Plant F	Plant G	Plant H	Plant I	Plant J	Plant K	Plant L
Method of Firing	Cyclone	Tangential	Circular Wall Burner	Opposed	Tangential	Tangential	Circular Wall Burner	Tangential	Circular Wall Burner	Circular Wall Burner
Coal Source	W Kentucky	E Kentucky	W Kentucky	W Kentucky S Illinois	W Kentucky	Virginia E Kentucky E Tennessee	W Kentucky	E Kentucky E Tennessee	S Illinois W Kentucky	W Kentucky N Alabama
Ash Content in Coal, %	11	15.5	15.3	16.3	15.7	15	14	19.1	15.6	16
Fly Ash of Total Ash, %	30	75	67	80	60	67	70	75	75	75
Bottom Ash of Total Ash, %	70	25	33	20	20	33	30	25	25	25
Sulfur Content in Coal, %	3.0	1.2	4.1	3.7	3.5	1.8	3.7	2.1	2.8	2.8
Coal Usage at Full Load (tons/day)	7848	8420	12897	24525	10503	8057	14460	16193	15304	17691
Number of Units	3	1	5	2	4	4	10	9	10	8
ESP Efficiency, %	-	99	74	99	60	-	75	70	60	60
Mechanical Ash Collector Efficiency, %	90-99	-	80	-	-	-	-	95	95	99
Overall Efficiency, %	-	99	95	-	98-99	99	75.5	98	98	70
Sludge Water to Ash Ratio (gal/ton)	23065	10770	9585	19490	12345	11425	42430	9520	17265	15370
pH of Intake Water	7.4	7.5	7.0	7.4	7.3	7.0	7.4	7.6	7.6	7.5
Suspended Solids Concentration of Intake Water (mg/l)	81	15	17	24	12	21	15	15	38	6
Alkalinity of Intake Water (mg/l as CaCO <sub>3</sub> )	83	95	53	69	63	73	58	55	66	63
% SiO <sub>2</sub> in Fly Ash	47.6	NA	46.9	NA	53.7	52.5	58.7	50.4	NA	45.3
% CaO in Fly Ash	1.72	NA	4.66	NA	2.36	2.19	3.17	1.92	NA	4.91
% Fe <sub>2</sub> O <sub>3</sub> in Fly Ash	11.3	NA	14.9	NA	9.6	10.2	10.7	11.6	NA	17.0
% Al <sub>2</sub> O <sub>3</sub> in Fly Ash	22.7	NA	18.6	NA	26.4	25.5	23.9	25.2	NA	27.0
% H <sub>2</sub> O in Fly Ash	0.93	NA	1.33	NA	1.12	1.42	1.24	1.29	NA	1.22
% SO <sub>3</sub> in Fly Ash	2.2	NA	1.5	NA	1.09	1.9	1.2	0.54	NA	1.16
% Moisture in Fly Ash	1.04	NA	0.32	NA	0.37	0.63	0.22	0.21	NA	0.87
pH of Fly Ash	2.9	NA	11.8	NA	4.5	3.6	4.6	4.0	NA	6.5
Ash Pond Effluent	7.1	8.4	11.1	11.1	9.5	8.7	11.0	7.5	10.8	10.1
Ash Pond Effluent Suspended Solids (mg/l)	30	19	<10	10	20	19	19	25	17	15

NOTE: Intake water characteristics based on 1974 and 1975 weekly samples  
Ash pond effluent characteristics based on 1970-1975 weekly samples  
All plants use combined fly ash/bottom ash ponds

Table V-36

NUMBER OF ASH PONDS IN WHICH AVERAGE EFFLUENT  
CONCENTRATIONS OF SELECTED TRACE ELEMENTS EXCEED  
THOSE OF THE INTAKE WATER (22)

<u>Element</u>	<u>No. Exceeding</u>
Aluminum	10
Ammonia	9
Arsenic	15
Barium	7
Beryllium	1
Cadmium	7
Calcium	15
Chloride	8
Chromium	10
Copper	5
Cyanide	3
Iron	4
Lead	8
Magnesium	6
Manganese	5
Mercury	12
Nickel	10
Selenium	14
Silica	12
Silver	2
Sulfate	15
Zinc	7

---

NOTE. The total number of ash ponds is 15.

Table V-37

## SUMMARY OF QUARTERLY TRACE METAL DATA FOR ASH POND INTAKE AND EFFLUENT STREAMS (22)

		Plant A Bottom Ash			Plant A Fly Ash			Plant B Bottom Ash			Plant B Fly Ash		
		Minimum	Average	Maximum	Minimum	Average	Maximum	Minimum	Average	Maximum	Minimum	Average	Maximum
Aluminum	EFF	0.5	3.2	8.0	3.6	7.9	13	0.4	2.2	8.6	0.6	1.6	4.8
	RW	0.5	2.6	6.7	0.5	2.6	6.7	0.4	0.8	1.6	0.4	0.8	1.6
Ammonia as N	EFF	0.04	0.11	0.34	0.02	0.75	3.1	<0.01	0.07	0.31	<0.01	0.07	0.20
	RW	0.02	0.07	0.14	0.02	0.07	0.14	0.04	0.08	0.08	0.04	0.08	0.08
Arsenic	EFF	<0.005	0.007	0.015	0.005	0.011	0.035	<0.005	0.014	0.055	<0.005	0.029	0.070
	RW	<0.005	<0.005	<0.005	<0.005	<0.005	<0.005	<0.005	<0.005	<0.005	<0.005	<0.005	<0.005
Barium	EFF	<0.1	0.1	0.1	<0.1	0.2	0.4	<0.1	0.1	0.3	<0.1	0.1	0.2
	RW	<0.1	0.2	0.4	<0.1	0.2	0.4	<0.1	<0.1	<0.1	<0.1	<0.1	<0.1
Beryllium	EFF	<0.01	<0.01	<0.01	<0.01	0.01	0.02	<0.01	<0.01	<0.01	<0.01	<0.01	<0.01
	RW	<0.01	<0.01	<0.01	<0.01	<0.01	<0.01	<0.01	<0.01	<0.01	<0.01	<0.01	<0.01
Cadmium	EFF	<0.001	0.001	0.002	0.023	0.038	0.052	<0.001	0.002	0.01	<0.001	0.001	0.002
	RW	<0.001	0.001	0.004	0.001	0.001	0.004	<0.001	0.004	0.01	<0.001	0.004	0.01
Calcium	EFF	23	38	67	88	126	180	17	50	200	27	152	430
	RW	21	35	48	21	35	48	17	19	20	17	19	20
Chloride	EFF	4	7	15	4	7	14	5	7	11	4	6	8
	RW	4	6	10	4	6	10	4	5	7	4	5	7
Chromium	EFF	<0.005	0.007	0.023	0.012	0.072	0.170	<0.005	0.009	0.026	<0.005	0.013	0.036
	RW	<0.005	0.010	0.024	0.005	0.010	0.024	<0.005	<0.005	<0.005	<0.005	<0.005	<0.005
Copper	EFF	0.01	0.07	0.14	0.16	0.33	0.45	<0.01	0.06	0.20	<0.01	0.03	0.10
	RW	0.04	0.09	0.19	0.04	0.09	0.19	<0.01	0.02	0.02	<0.01	0.02	0.02
Cyanide	EFF	<0.01	<0.01	<0.01	<0.01	<0.01	<0.01	<0.01	<0.01	<0.01	<0.01	<0.01	<0.01
	RW	-	-	-	-	-	-	-	-	-	-	-	-
Iron	EFF	1.7	5.2	11	0.33	2.3	8.6	0.26	4.7	30	0.14	1.4	7.1
	RW	1.1	2.7	6.7	1.1	2.7	6.7	0.32	0.57	0.90	0.32	0.57	0.90
Lead	EFF	<0.010	0.017	0.031	<0.010	0.066	0.200	<0.010	0.018	0.048	<0.01	0.015	0.030
	RW	<0.010	0.021	0.038	<0.010	0.021	0.038	<0.01	<0.01	<0.01	<0.01	<0.01	<0.01
Magnesium	EFF	0.3	6.0	9.3	9.4	14	20	4.1	6.2	21	0.2	3.6	6.8
	RW	4.1	6.1	8.0	4.1	6.1	8.0	3.6	4.3	4.7	3.6	4.3	4.7
Manganese	EFF	0.07	0.17	0.26	0.29	0.49	0.63	0.02	0.40	3.6	0.02	0.12	0.63
	RW	0.08	0.13	0.25	0.08	0.13	0.25	0.04	0.06	0.08	0.04	0.06	0.08
Mercury	EFF	<0.0002	0.0005	0.0026	<0.0002	0.0003	0.0006	<0.0002	0.0009	0.0042	<0.0002	0.0008	0.0056
	RW	<0.0002	<0.0002	<0.0002	<0.0002	<0.0002	<0.0002	<0.0002	<0.0002	<0.0002	<0.0002	<0.0002	<0.0002
Nickel	EFF	<0.05	0.06	0.12	<0.05	0.08	0.13	<0.05	0.06	0.14	<0.05	0.05	0.03
	RW	<0.05	<0.05	<0.05	<0.05	<0.05	<0.05	<0.05	<0.05	<0.05	<0.05	<0.05	<0.05
Selenium	EFF	<0.001	0.002	0.004	<0.001	0.002	0.004	<0.001	0.007	0.056	0.001	0.015	0.064
	RW	<0.001	0.002	0.002	<0.001	<0.002	<0.002	<0.002	0.002	0.002	<0.002	<0.002	<0.002

Table V-37 (Continued)

SUMMARY OF QUARTERLY TRACE METAL DATA FOR ASH POND INTAKE AND EFFLUENT STREAMS (22)

		Plant A Bottom Ash			Plant A Fly Ash			Plant B Bottom Ash			Plant B Fly Ash		
		Minimum	Average	Maximum	Minimum	Average	Maximum	Minimum	Average	Maximum	Minimum	Average	Maximum
Silica	EFF	5.6	7.4	9.3	9.3	13	20	3.7	6.4	22	3.1	7.1	22
	RW	1.7	5.6	8.0	1.7	5.6	8.0	3.2	5.4	7.2	3.2	5.4	7.2
Silver	EFF	<0.01	<0.01	<0.01	<0.01	<0.01	<0.01	<0.01	<0.01	<0.01	<0.01	<0.01	<0.01
	RW	<0.01	<0.01	<0.01	<0.01	<0.01	<0.01	0.01	0.02	0.05	0.01	0.02	0.05
Dissolved Solids	EFF	140	185	260	470	593	700	110	229	710	40	458	1100
	RW	120	154	200	120	154	200	90	93	100	90	93	100
Suspended Solids	EFF	5	52	200	1	6	17	2	23	78	2	13	39
	RW	14	60	190	14	60	190	8	11	14	8	11	14
Sulfate	EFF	23	45	80	240	346	440	20	102	470	17	214	480
	RW	6	21	30	6	21	30	9	12	18	9	12	18
Zinc	EFF	0.02	0.08	0.16	0.82	1.4	2.7	0.02	0.13	0.55	0.01	0.05	0.13
	RW	0.06	0.09	0.14	0.06	0.09	0.14	0.01	0.02	0.04	0.01	0.02	0.04

NOTE Effluent data based on years 1973-1975  
Raw water intake data based on years 1974 and 1975

KEY EFF - effluent  
RW - raw water (intakes)

concentrations In both plants, iron was found in higher concentrations in the bottom ash than the fly ash Selenium, mercury, and cyanide were found in very low concentrations Arsenic was below 0.05 mg/l in all four ponds In both plants, the dissolved solids were higher in the fly ash ponds while the suspended solids were higher in the bottom ash ponds

Table V-38 provides plant operating information for Plants A and B. Plant A has a cyclone furnace that produces approximately 70 percent bottom ash and 30 percent fly ash, while Plant B has pulverized coal-fired boilers which produce 50 percent bottom ash and 50 percent fly ash

NUS Corporation Data. Table V-39 provides trace element information for separate fly ash and bottom ash ponds. These data were compiled by NUS Corporation (23). Nickel and manganese was evenly distributed between both types of ash ponds, zinc was slightly higher in the fly ash ponds, copper was slightly higher in the bottom ash ponds. The fly ash pond of southeastern Ohio was the only pond that demonstrated arsenic levels which exceeded 50 ppb

### Sampling Program Results

Screening Phase The purpose of the screening phase of the sampling program was to identify the pollutants in the discharge streams The screening phase for the ash transport stream included the sampling of five ash pond overflows. Table V-40 presents the analytical results for sampling for the 129 priority pollutants

Verification Phase The verification phase involved the sampling of nine facilities for ash pond overflow to further quantify those effluent species identified in the screening program. The data reported as a result of this effort are summarized in table V-41. One of the plants (1226) was sampled by two laboratories and both sets of results are reported.

### Arsenic Levels

Table V-42 presents data for plants in which arsenic concentrations in the ash pond discharge streams exceed the Interim Drinking Water Standard of 50 ppb The maximum arsenic level is 416 ppb Other data concerning arsenic levels in ash pond effluents are given in table V-43 Two plants exceed the 50 ppb level. Intake water concentrations for arsenic are provided in tables V-40, V-41, and V-43. The increases in arsenic concentrations, from the plant intake water to the ash pond overflow, range from no increase at all for a number of plants to a 300 ppb increase for plant 2603 in Table V-41 The range of arsenic levels in ash pond effluents is from less than 1 ppb to 416 ppb

Table V-38

SUMMARY OF PLANT OPERATING CONDITIONS AND ASH  
CHARACTERISTICS OF TVA COAL-FIRED POWER PLANTS

<u>Parameters</u>	<u>Plant A</u>	<u>Plant B</u>
Method of Firing	Cyclone	Circular Wall Burners
Coal Source	W. Kentucky	W. Kentucky
Ash Content in Coal, %	18.8	14.8
Fly Ash of Total Ash, %	30	50
Bottom Ash of Total Ash, %	70	50
Sulfur Content in Coal, %	4.1	-
Coal Usage at Full Load (tons/day)	22901	3314
Number of Units	3	4
ESP Efficiency, %	-	-
Mechanical Ash Collector Efficiency, %	98	-
Overall Efficiency, %	98	-
Sluice Water to Ash Ratio (gal/ton)	12380 <sup>f</sup> 9810 <sup>b</sup>	- -
pH of Intake Water	7.7	7.5
Suspended Solids Concentration of Intake Water (mg/l)	60	41
Alkalinity of Intake Water (mg/l as CaCO <sub>3</sub> )	97	56
% SiO <sub>2</sub> in Fly Ash	NA	NA
% CaO in Fly Ash	NA	NA
% Fe <sub>2</sub> O <sub>3</sub> in Fly Ash	NA	NA
% Al <sub>2</sub> O <sub>3</sub> in Fly Ash	NA	NA
% MgO in Fly Ash	NA	NA



Table V-38 (Continued)

SUMMARY OF PLANT OPERATING CONDITIONS AND ASH  
CHARACTERISTICS OF TVA COAL-FIRED POWER PLANTS

<u>Parameters</u>	<u>Plant A</u>	<u>Plant B</u>
Ash Pond Effluent pH	4.4 <sup>f</sup> 7.2 <sup>b</sup>	9.8 <sup>f</sup> 8.0 <sup>b</sup>
Ash Pond Effluent Suspended Solids (mg/l)	25 <sup>f</sup> 55 <sup>b</sup>	85 <sup>f</sup> 64 <sup>b</sup>

---

<sup>f</sup>Fly Ash Pond Only

<sup>b</sup>Bottom Ash Pond Only

NOTE. Intake water characteristics based on 1974 and 1975 weekly samples. Ash pond effluent characteristics based on 1970-1075 weekly samples.

Table V-39

## ASH POND EFFLUENT TRACE ELEMENT CONCENTRATIONS\* (23)

<u>Station Location</u>	<u>Ash Pond Type</u>	(ppb)				
		<u>Arsenic</u>	<u>Copper</u>	<u>Nickel</u>	<u>Zinc</u>	<u>Manganese</u>
Western W. Virginia	Bottom	<5	<1	11	10	130
Eastern Ohio	Bottom	7	10	30	90	300
Southern Ohio	Bottom	<5	60	30	40	180
Eastern Michigan	Bottom	30	<1	20	270	70
Southeast Michigan	Fly	40	<1	20	240	5
Southeast Ohio	Fly	200	6	30	50	4
Eastern Missouri	Bottom	20	3	20	50	240
Central Utah	Bottom	<5	6	1	5	5
Western W. Virginia	Fly	8	5	30	40	550
Southern Ohio	Fly	10	4	<1	80	10

---

\*Minimum Quantifiable Concentrations/Arsenic (5 ppb), Copper (1 ppb), Nickel (1 ppb), Zinc (1 ppb), Manganese (1 ppb).

Table V-40

## SCREENING DATA FOR ASH POND OVERFLOW

Plant Code	Pollutant	Concentration (ppb)		
		Intake	Discharge	
4222 (Combined Fly Ash and Bottom Ash)	Methylene Chloride	12	27	
	Trichlorofluoromethane	ND<1/1	6/ND<1	
	Phenol	2/<100	1/260	
	Bis(2-Ethylhexyl) Phthalate	2	1	
	Butyl Benzyl Phthalate	1	1	
	Toluene	3/2	3/4	
	Methylene Chloride	8	18	
	Antimony, Total	<5	29	
	Arsenic, Total	<5	160	
	Beryllium, Total	<5	20	
	Chromium, Total	<5	11	
	Copper, Total	16	6	
	Mercury, Total	0.26	0.21	
	Nickel, Total	6	8	
	Selenium, Total	<5	32	
	Zinc, Total	14	10	
	2414 (Combined Fly Ash and Bottom Ash)	Benzene	6/13	3/2
		Chloroform	2	ND < 1
		Methylene Chloride	4/1	ND<1/2
		Phenol	45/<100	ND<1/31
Bis(2-Ethylhexyl) Phthalate		12	40	
Diethyl Phthalate		3	ND < 1	
Toluene		21/1	11/70	
Cis 1,2-Dichloroethylene		ND<1/15	30/ND<1	
1,1,1-Trichloroethane		ND < 1	1	
1,4-Dichlorobenzene		ND < 1	1	
Ethylbenzene		1	2	
Arsenic, Total		5	50	
Asbestos (fibers/liter)		28,400	0	
Chromium, Total		<5	14	
Copper, Total		21	66	
Cyanide, Total		<20	80	
Lead, Total		7	8	
Mercury, Total		0.88	0.63	
Nickel, Total		8	144	
Selenium, Total		15	22	
Silver, Total		45	52	
Thallium, Total		6	8	
Zinc, Total		<5	41	

Table V-40 (Continued)

## SCREENING DATA FOR ASH POND OVERFLOW

Plant Code	Pollutant	Concentration (ppb)	
		Intake	Discharge
3805 (Combined Fly Ash and Bottom Ash)	Benzene	1/6	ND<1/2
	1,1,1-Trichloroethane	2	ND < 1
	Chloroform	1/3	2/4
	1,1-Dichloroethylene	ND<1/1	1/ND<1
	Ethylbenzene	20	ND < 1
	Methylene Chloride	22/10	8/15
	Trichlorofluoromethane	40	1
	Phenol	2	3
	Bis(2-Ethylhexyl) Phthalate	ND < 1	6
	Tetrachloroethylene	1	ND < 1
	Toluene	42/14	4/6
	Trichloroethylene	2	ND < 1
	Cis 1,2-Dichloroethylene	3	ND < 1
	Chromium, Total	39	<5
	Copper, Total	6	5
	Lead, Total	19	<5
	Mercury, Total	0.23	0.32
	Selenium, Total	11	<5
	Silver, Total	12	<5
	Zinc, Total	5	5
3404 (Bottom Ash)	Benzene	1	1
	Chloroform	3/1	ND<1/1
	1,1-Dichloroethylene	1/1	1/ND<1
	Methylene Chloride	20/1	4/ND<1
	Phenol	ND<1/36	1/20
	Bis(2-Ethylhexyl) Phthalate	11	9
	Di-N-Butyl Phthalate	4	1
	Toluene	3/3	3/2
	Antimony, Total	11	12
	Arsenic, Total	<5	14
	Cadmium, Total	15	13
	Chromium, Total	16	20
	Copper, Total	25	29
	Lead, Total	5	5
	Mercury, Total	0.34	0.32
	Nickel, Total	21	33
	Selenium, Total	55	42
	Silver, Total	40	19
	Zinc, Total	<5	8

Table V-40 (Continued)

## SCREENING DATA FOR ASH POND OVERFLOW

<u>Plant Code</u>	<u>Pollutant</u>	<u>Concentration (ppb)</u>	
		<u>Intake</u>	<u>Discharge</u>
2512 (Fly Ash)	Benzene	ND<1/1	1/ND<1
	1,1,1-Trichloroethane	ND<1/ND<1	2/3
	Chloroform	2/3	1/ND<1
	1,1-Dichloroethylene	1/2	ND<1/2
	Ethylbenzene	ND<1/1	1/ND<1
	Methylene Chloride	23/12	35/5
	Bis(2-Ethylhexyl) Phthalate	1	27
	Di-N-Butyl Phthalate	ND < 1	1
	Toluene	2/7	4/3
	1,4-Dichlorobenzene	7	ND < 1
	Antimony, Total	<5	5
	Arsenic, Total	6	7
	Copper, Total	22	14
	Lead, Total	<5	12
	Mercury, Total	0.21	0.22
	Nickel, Total	7	1,500
	Selenium, Total	35	32
	Zinc, Total	<5	17

Table V-41

SUMMARY OF DATA FROM THE VERIFICATION PROGRAM AND EPA SURVEILLANCE  
AND ANALYSIS REPORTS FOR ASH POND OVERFLOW

Plant Code	Pollutant	Concentration (ppb)	
		Intake	Discharge
1742 (Combined Fly Ash and Bot- tom Ash Pond)	Cadmium, Total (Dissolved)	40(5)	10(9)
	Chromium, Total (Dissolved)	24/20*(ND/30)*	23/2000*(ND/30)*
	Copper, Total (Dissolved)	21/20*(ND/9)*	106/50*(54/7)*
	Lead, Total (Dissolved)	9/ND<20*(ND/90)*	9/ND<20*(3/100)*
	Mercury, Total (Dissolved)	ND < 0.5	1.5(1)
	Nickel, Total (Dissolved)	17/ND<5*(ND/40)*	39/900*(1/40)
	Zinc, Total (Dissolved)	ND/70*(30/ND<60)*	ND/ND<60*(20/ND<60)*
	Total Dissolved Solids	340,000	370,000
	Total Suspended Solids	100,000	15,000
	Total Organic Carbon	10,000	150,000
	Aluminum, Total	2,000	ND < 50
	Barium, Total (Dissolved)	60(30)	50(50)
	Boron, Total (Dissolved)	90(200)	200(400)
	Calcium, Total (Dissolved)	51,000(44,000)	51,000(53,000)
	Cobalt, Total (Dissolved)	10(7)	50(10)
	Manganese, Total (Dissolved)	200(10)	300(ND<5)
	Magnesium, Total (Dissolved)	23,000(22,000)	20,000(22,000)
	Molybdenum, Total (Dissolved)	9(40)	50(50)
	Phenolics, 4AAP	6	12
	Sodium, Total (Dissolved)	21,000(20,000)	26,000(25,000)
	Tin, Total (Dissolved)	30(60)	30(60)
	Titanium, Total	40	ND < 20
	Iron, Total	4,000	8,000
Vanadium, Total (Dissolved)	ND/ND<10*(ND/20)	ND/20*(ND/30)*	
Silver (Dissolved)	(ND/10)*	(ND/10)*	

\*These multiple results represent analyses by multiple analytical labs.  
( )Values in parentheses indicate dissolved fractions.

Table V-41 (Continued)

SUMMARY OF DATA FROM THE VERIFICATION PROGRAM AND EPA SURVEILLANCE  
AND ANALYSIS REPORTS FOR ASH POND OVERFLOW

Plant Code	Pollutant	Concentration (ppb)	
		Intake	Discharge
1741 (Bottom Ash)	Cadmium, Total (Dissolved)	ND < 2(3)	10(8)
	Chromium, Total (Dissolved)	ND/4,000*(ND/20)*	9/ND<5*(ND/20)*
	Copper, Total (Dissolved)	ND/90*(ND/9)*	35/10*(13/7)*
	Lead, Total (Dissolved)	ND/20*(ND/100)*	14/ND<20*(ND<4/100)*
	Mercury, Total	ND	1
	Nickel, Total (Dissolved)	ND/2000*(ND/20)*	15/ND<5*(ND/50)*
	Zinc, Total (Dissolved)	ND/ND<60*(20/ND<60)*	ND/70*(ND/100)*
	Total Dissolved Solids	130,000	4,000
	Total Suspended Solids	10,000	160,000
	Total Organic Carbon	5,000	17,000
	Aluminum, Total	200	ND < 50
	Barium, Total (Dissolved)	30(30)	60(60)
	Boron, Total (Dissolved)	70(ND<50)	80(100)
	Calcium, Total (Dissolved)	10,000(13,000)	21,000(24,000)
	Cobalt, Total (Dissolved)	40(6)	ND < 5 (8)
	Manganese, Total (Dissolved)	800(ND<5)	100(700)
	Magnesium, Total (Dissolved)	9,800(5,100)	5,600(5,800)
	Molybdenum, Total (Dissolved)	60(30)	8(30)
	Phenolics, 4AAP	ND	11
	Sodium, Total (Dissolved)	D<15,000(D<15,000)	D<15,000(D<15,000)
	Tin, Total (Dissolved)	ND < 5(30)	20(20)
	Titanium, Total	30	ND < 30
	Iron, Total	20,000	200
	Vanadium, Total (Dissolved)	ND/10(ND<10/ND)*	ND/ND<10(ND/10)
	Beryllium, Dissolved)	(3)	(2)
	Silver, (Dissolved)	(ND/6)*	(ND/9)*

\*These multiple results represent analyses by multiple analytical labs.  
( )Values in parentheses indicate dissolved fractions.

Table V-41 (Continued)

SUMMARY OF DATA FROM THE VERIFICATION PROGRAM AND EPA SURVEILLANCE  
AND ANALYSIS REPORTS FOR ASH POND OVERFLOW

Plant Code	Pollutant	Concentration (ppb)	
		Intake†	Discharge
1741 (Fly Ash)	Cadmium, Total (Dissolved)		90(70)
	Chromium, Total (Dissolved)		12/6*(ND/20)*
	Copper, Total (Dissolved)		15/9*(4/7)*
	Lead, Total (Dissolved)		120/ND<20*(6/80)*
	Nickel, Total (Dissolved)		100/50*(58/90)*
	Zinc, Total (Dissolved)		1400/1000*(ND/1000)*
	Total Dissolved Solids		790,000
	Total Suspended Solids		6,000
	Total Organic Carbon		18,000
	Barium, Total (Dissolved)		100(100)
	Boron, Total (Dissolved)		3,000(5,000)
	Calcium, Total (Dissolved)		140,000(160,000)
	Cobalt, Total (Dissolved)		10(20)
	Manganese, Total (Dissolved)		1,000(1000)
	Magnesium, Total (Dissolved)		9,500(10,000)
	Molybdenum, Total (Dissolved)		200(300)
	Phenolics, 4AAP		9
	Sodium, Total (Dissolved)		D<15,000(D<15,000)
	Tin, Total (Dissolved)		30(20)
	Titanium, Total		20
	Iron, Total		900
	Beryllium, (Dissolved)		2
	Silver (Dissolved)		(ND/10)*
Vanadium (Dissolved)		(ND/20)*	
Yttrium (Dissolved)		(40)	

178

†Same intake as for Plant 1741, Bottom Ash Pond.

\*These multiple results represent analyses by multiple analytical labs.

()Values in parentheses indicate dissolved fractions.



Table V-41 (Continued)

SUMMARY OF DATA FROM THE VERIFICATION PROGRAM AND EPA SURVEILLANCE  
AND ANALYSIS REPORTS FOR ASH POND OVERFLOW

Plant Code	Pollutant	Concentration (ppb)	
		Intake	Discharge
1226 (Combined Fly Ash and Bot- tom Ash Pond)	Antimony, Total	ND/7*	ND/7*
	Arsenic, Total	ND/3*	ND/9*
	Cadmium, Total	2.1/ND<2*	2/ND<2*
	Chromium, Total	ND/7/7*	ND/6/10*
	Copper, Total (Dissolved)	10/12/10*(10)	18/14/10*(13/9)*
	Lead, Total (Dissolved)	12/10/ND<20*(7/ND<20)*	9/4*(4/ND<20)*
	Mercury, Total	ND<1/0.5*	ND<0.5/ND<0.2*
	Nickel, Total (Dissolved)	27/1.5/ND<5*(29/ND<5)*	ND/5.5/5*(ND/ND<5)*
	Selenium, Total	ND/ND<2*	ND/8*
	Silver, Total	ND/1.5/ND<1*	ND/0.5/ND<1*
	Zinc, Total (Dissolved)	ND/9/70*(50/ND<60)*	ND/7/ND<60*(ND/ND<60)*
	Total Dissolved Solids	190,000	2,350,000
	Total Suspended Solids	14,000	12,000
	Aluminum, Total (Dissolved)	700(100)	300(500)
	Barium, Total (Dissolved)	20(20)	60(60)
	Boron, Total (Dissolved)	ND < 50(70)	400(900)
	Calcium, Total (Dissolved)	6,900(D<5,000)	34,000(32,000)
	Cobalt, Total	7	ND < 5
	Manganese, Total (Dissolved)	200(200)	30(6)
	Magnesium, Total (Dissolved)	4,500(5,000)	7,300(7,500)
	Molybdenum, Total (Dissolved)	ND < 5(ND<5)	100(100)
	Phenolics, 4AAP	12	17
	Sodium, Total (Dissolved)	33,000(36,000)	66,000(72,000)
Titanium, Total	20	ND < 20	
Iron, Total (Dissolved)	2,000(1,000)	600(ND<200)	
Vanadium, Total (Dissolved)	ND/40/ND<10*(ND/ND<10)*	ND/78/50*(ND/40)*	

\*These multiple results represent analyses by multiple analytical labs.  
( )Values in parentheses indicate dissolved fractions.

Table V-41 (Continued)

SUMMARY OF DATA FROM THE VERIFICATION PROGRAM AND EPA SURVEILLANCE  
AND ANALYSIS REPORTS FOR ASH POND OVERFLOW

Plant Code	Pollutant	Concentration (ppb)	
		Intake	Discharge
5409 (Fly Ash)	Benzene	2.4	2
	Carbon Tetrachloride	D < 1	-----
	Chloroform	1.4	-----
	1,2-Dichlorobenzene	5.3	-----
	Ethylbenzene	-----	D < 1
	Toluene	2	3.5
	Trichloroethylene	D < 4	-----
	Antimony, Total	3	6
	Beryllium, Total	ND < 0.5	2.5
	Cadmium, Total	1.4	1.0
	Chromium, Total	ND < 2	4
	Copper, Total	27	80
	Cyanide, Total	15,000	22
	Lead, Total	8	ND < 3
	Nickel, Total	1.7	9.5
	Selenium, Total	2.0	3.0
	Silver, Total	1.6	5.5
	Thallium, Total	1	ND < 1
	Zinc, Total	15	300
	Total Suspended Solids	5	15,000
	Total Organic Carbon Chloride	D < 20,000 -----	7,600 37,000
	Vanadium, Total	13	27
	1,3 and 1,4-Dichlorobenzene	2.4	2.4

\*These multiple results represent analyses by multiple analytical labs.  
( ) Values in parentheses indicate dissolved fractions.

Table V-41 (Continued)

SUMMARY OF DATA FROM THE VERIFICATION PROGRAM AND EPA SURVEILLANCE  
AND ANALYSIS REPORTS FOR ASH POND OVERFLOW

Plant Code	Pollutant	Concentration (ppb)	
		Intake	Discharge
2603 (Combined Fly Ash and Bot- tom Ash Pond)	Benzene	D < 10	D < 10
	Chloroform	D < 10	D < 10
	1,1-Dichloroethylene	ND	D < 10
	Ethylbenzene	ND	D < 10
	Methylene Chloride	D < 10	10
	Phenol (GC/MS)	ND/9*	ND/4*
	Bis(2-Ethylhexyl)Phthalate	D < 10	D < 10
	Butyl Benzyl Phthalate	D < 10	ND
	Di-N-Butyl Phthalate	D < 10	D < 10
	Diethyl Phthalate	50	10
	Dimethyl Phthalate	ND	D < 10
	Tetrachloroethylene	D < 10	ND
	Antimony, Total	ND < 2	10
	Arsenic, Total	ND < 20	300
	Cadmium, Total	ND < 2	3
	Chromium, Total	10	12
	Copper, Total	22	10
	Mercury, Total	0.2	-----
	Nickel, Total	8	10
	Selenium, Total	ND < 2	13
	Silver, Total	ND < 1	4
	Zinc, Total	88	ND < 60
	Total Dissolved Solids	292,000	455,000
Total Suspended Solids	-----	D < 5000	
Oil and Grease	-----	1,000	
Total Organic Carbon	9,000	6,000	
Aluminum, Total	497	131	

\*These multiple results represent analyses by multiple analytical labs.  
( ) Values in parentheses indicate dissolved fractions.

Table V-41 (Continued)

SUMMARY OF DATA FROM THE VERIFICATION PROGRAM AND EPA SURVEILLANCE  
AND ANALYSIS REPORTS FOR ASH POND OVERFLOW

Plant Code	Pollutant	Concentration (ppb)	
		Intake	Discharge
2603 (Cont'd)	Barium, Total	17	92
	Boron, Total	ND < 50	209
	Calcium, Total	48,700	62,100
	Manganese, Total	65	10
	Magnesium, Total	15,300	15,500
	Molybdenum, Total	ND < 5	143
	Sodium, Total	23,600	32,000
	Tin, Total	36	36
	Titanium, Total	18	ND < 15
	Iron, Total	842	170
	Vanadium, Total	-----	22
182 5604 (Combined Fly Ash)	Benzene	1.2	2.0
	Ethylbenzene	-----	D < 1
	Toluene	9.1	3.5
	Antimony, Total	4	6
	Beryllium, Total	ND < 0.5	2.5
	Cadmium, Total	ND < 0.5	1.0
	Chromium, Total	ND < 2	4
	Copper, Total	700	80
	Cyanide, Total	4	22
	Lead, Total	6	ND < 3
	Mercury, Total	ND < 0.2	0.2
	Nickel, Total	ND < 0.5	9.5
	Silver, Total	ND < 3	5.5
	Zinc, Total	53	300
	Total Suspended Solids	-----	15,000
	Total Organic Carbon	5,500	7,600
	Chloride	14,000	37,000
	Vanadium, Total	11	27

\*These multiple results represent analyses by multiple analytical labs.  
( ) Values in parentheses indicate dissolved fractions.

Table V-41 (Continued)

SUMMARY OF DATA FROM THE VERIFICATION PROGRAM AND EPA SURVEILLANCE  
AND ANALYSIS REPORTS FOR ASH POND OVERFLOW

Plant Code	Pollutant	Concentration (ppb)	
		Intake	Discharge
3920 (Fly Ash)	Beryllium, Total (Dissolved)	ND (ND)	2(2)
	Chromium, Total (Dissolved)	20/2*(10/ND<5)*	50/9*(41/8)*
	Copper, Total (Dissolved)	ND<6/8(4/ND<6)*	ND/30*(ND/40)*
	Lead, Total (Dissolved)	20/ND<20*(18/40)*	8/ND<20*(14/30)*
	Nickel, Total (Dissolved)	25/ND<3*(14/ND<5)*	16/20*(ND<9/40)*
	Zinc, Total (Dissolved)	ND/ND<60*(ND/ND<60)*	180/100*(ND/200)*
	Total Dissolved Solids	220,000	880,000
	Total Suspended Solids	12,000	73,000
	Total Organic Carbon	5,000	3,000
	Aluminum, Total (Dissolved)	ND<50(ND<50)	5,000(6,000)
	Barium, Total (Dissolved)	30(30)	60(ND<5)
	Boron, Total (Dissolved)	80(90)	1,000(5,000)
	Calcium, Total (Dissolved)	28,000(27,000)	120,000(120,000)
	Cobalt, Total (Dissolved)	ND<5(ND<5)	7(7)
	Manganese, Total (Dissolved)	50(50)	300(500)
	Magnesium, Total (Dissolved)	7,200(7,400)	6,700(9,700)
	Molybdenum, Total (Dissolved)	ND<5(6)	10(8)
	Phenolics, 4AAP	40	40
	Sodium, Total (Dissolved)	18,000(17,000)	35,000(47,000)
	Iron, Total	500	2,000
	Cadmium (Dissolved)	(ND<3)	(10)
	Silver (Dissolved)	(ND/ND)*	(ND/5)*
	Tin (Dissolved)	(20)	(20)

\*These multiple results represent analyses by multiple analytical labs.  
( )Values in parentheses indicate dissolved fractions.

Table V-41 (Continued)

SUMMARY OF DATA FROM THE VERIFICATION PROGRAM AND EPA SURVEILLANCE  
AND ANALYSIS REPORTS FOR ASH POND OVERFLOW

Plant Code	Pollutant	Concentration (ppb)	
		Intake	Discharge
3924 (Fly Ash)	Chromium, Total (Dissolved)	7/ND<5*(ND/ND<5)*	27/70*(49/ND<5)*
	Copper, Total (Dissolved)	18/10*(16/9)*	32/ND<6*(42/ND<6)*
	Lead, Total (Dissolved)	10/ND<20*(5/ND<20)*	23/ND<20*(1/ND<20)*
	Nickel, Total (Dissolved)	18/ND<5*(ND/ND<5)*	23/40*(10/6)*
	Zinc, Total (Dissolved)	20/ND<60*(20/ND<60)*	20/ND<60*(ND/ND<60)*
	Total Dissolved Solids	480,000	670,000
	Total Suspended Solids	15,000	16,000
	Total Organic Carbon	21,000	16,000
	Barium, Total (Dissolved)	40(40)	200(200)
	Boron, Total (Dissolved)	100(100)	1,000(4,000)
	Calcium, Total (Dissolved)	57,000(55,000)	110,000(110,000)
	Manganese, Total (Dissolved)	100(50)	80(70)
	Magnesium, Total (Dissolved)	13,000(14,000)	14,000(14,000)
	Molybdenum, Total (Dissolved)	ND<5(ND<5)	300(300)
	Phenolics, 4AAP	38	35
	Sodium, Total (Dissolved)	43,000(44,000)	38,000(39,000)
	Iron, Total	500	300
	Aluminum (Dissolved)	ND < 50	60
	Tin (Dissolved)	(20)	(ND<5)
	3001 (Combined Fly Ash and Bot- tom Ash Pond)	Chromium, Total (Dissolved)	ND/10*(ND/10)*
Copper, Total (Dissolved)		ND/10*(22/ND<6)	ND/ND<6*(20/ND<6)*
Lead, Total (Dissolved)		ND/ND<20*(ND/ND<20)*	3/ND<20*(4/ND<20)*
Nickel, Total (Dissolved)		ND/6*(ND/ND<5)*	35/ND<5*(33/ND<5)*
Total Dissolved Solids		532,000	490,000
Total Suspended Solids		170,000	30,000
Oil and Grease		25,000	24,000
Aluminum, Total (Dissolved)		500(ND<50)	2,000(200)

\*These multiple results represent analyses by multiple analytical labs.  
( )Values in parentheses indicate dissolved fractions.

Table V-41 (Continued)

SUMMARY OF DATA FROM THE VERIFICATION PROGRAM AND EPA SURVEILLANCE  
AND ANALYSIS REPORTS FOR ASH POND OVERFLOW

Plant Code	Pollutant	Concentration (ppb)	
		Intake	Discharge
3001 (Cont'd)	Barium Total (Dissolved)	40(60)	200(80)
	Boron, Total (Dissolved)	60(200)	2,000(2,000)
	Calcium, Total (Dissolved)	38,000(48,000)	64,000(38,000)
	Manganese, Total	40	ND < 5
	Cadmium (Dissolved)	ND < 2	8
	Magnesium, Total (Dissolved)	23,000(27,000)	11,000(11,000)
	Molybdenum, Total (Dissolved)	ND < 5(ND<5)	30(20)
	Phenolics, 4AAP	-----	14
	Sodium, Total (Dissolved)	57,000(66,000)	70,000(69,000)
	Tin, Total (Dissolved)	ND < 5(20)	7(20)
	Iron, Total	200	ND < 200
	Vanadium, Total	ND/ND<10*	ND/20*
	1,1,2,2-Tetrachloroethane	24	-----
	Zinc (Dissolved)	(ND/ND<60)*	(20/ND<60)*
5410 (Combined Fly Ash and Bot- tom Ash Pond)	Cadmium, Total (Dissolved)	9(6)	4(ND<2)
	Chromium, Total (Dissolved)	7/70*(9/7)*	16/100*(ND/ND<5)*
	Copper, Total (Dissolved)	15/6*(9/ND<6)*	29/20*(61/10)*
	Lead, Total (Dissolved)	17/ND<20*(9/ND<20)*	ND/40(ND/ND<20)*
	Nickel, Total (Dissolved)	22/30*(9/6)*	66/100*(43/30)*
	Silver, Total (Dissolved)	ND/ND<1*(ND/2)*	ND/6*(ND/2)*
	Zinc, Total	20/ND<60*(ND/ND<60)*	40/ND<60*(30/ND<60)*
	Total Dissolved Solids	200,000	300,000
	Total Suspended Solids	9,000	20,000
	Total Organic Carbon	9,000	8,000
	Aluminum, Total	ND < 50	800
	Barium, Total (Dissolved)	30(30)	40(30)
	Boron, Total (Dissolved)	60(70)	100(300)

\*These multiple results represent analyses by multiple analytical labs.  
( )Values in parentheses indicate dissolved fractions.

Table V-41 (Continued)

SUMMARY OF DATA FROM THE VERIFICATION PROGRAM AND EPA SURVEILLANCE  
AND ANALYSIS REPORTS FOR ASH POND OVERFLOW

Plant Code	Pollutant	Concentration (ppb)	
		Intake	Discharge
5410	Calcium, Total (Dissolved)	27,000(27,000)	40,000(38,000)
(Cont'd)	Cobalt, Total	ND < 5	20
	Manganese, Total (Dissolved)	40(ND<5)	100(200)
	Magnesium, Total (Dissolved)	7,700(7,300)	9,100(8,200)
	Molybdenum, Total	ND < 5	8
	Phenolics, 4AAP	9	6
	Sodium, Total (Dissolved)	18,000(17,000)	22,000(24,000)
	Tin, Total (Dissolved)	10(ND<5)	10(6)
	Titanium, Total	ND < 20	50
	Iron, Total	400	2,000
	Vanadium, Total	ND/ND<10*	ND/10*
	Yttrium, Total	ND < 20	20
	Arsenic (Dissolved)	ND	14
4203	1,1,1-Trichloroethane	0.68	-----
(Combined	Chloroform	0.17	0.25
Fly Ash	Methylene Chloride	-----	32
and Bot-	Pentachlorophenol	3.8	6.5
tom Ash	Tetrachloroethylene	0.4	-----
Pond)	Trichloroethylene	0.57	-----
	4,4'-DDD (P,P'-TDE)	D < 0.1	-----
	Arsenic, Total	2	-----
	Cadmium, Total	4	ND < 2
	Chromium, Total	3	13
	Copper, Total	8	8
	Lead, Total	1.7	1.2
	Nickel, Total	18	24
	Selenium, Total	3	ND < 1
	Silver, Total	ND < 2 *	2
	Zinc, Total	32	15
	Iron, Total	1,100	1,200

186

\*These multiple results represent analyses by multiple analytical labs.  
 ()Values in parentheses indicate dissolved fractions.



Table V-42

CONDITIONS UNDER WHICH ARSENIC IN ASH POND OVERFLOW EXCEEDS 0.05 mg/l (19)  
(mg/l)

Plant Code	Plant Capacity	Fuel*	pH	SS	As	Cu	Cr	Cd	Ni	Pb	Hg	Zn	Se	Oil and Grease	No. of Samples	
3711	781	c/o	6.48	24.5	0.06	0.1	0.05	0.02	0.1	0.36	0.1	0.002	0.14	0.007	0.23	18
3708	466	c/o	8.48	14.7	0.14	0.1	0.05	0.02	0.1	0.14	0.1	0.003	0.01	0.005	0.16	6
0512	1341	c	8.29	16.5	0.19	0.01	0.01	-	0.01	0.63	0.14	0.001	0.04	0.011	4.0	7
3710	290	c/o	9.07	127	0.416	0.12	0.05	0.02	0.1	0.3	0.1	0.0023	0.11	0.05	0.13	3
4218	1163	c/o	6.63	36.8	0.131	0.075	0.002	-	0.038	0.74	0.002	0.0005	0.087	-	0.9	1
3701	421	c/o	-	18.0	0.09	0.05	0.05	0.01	0.05	0.47	0.05	0.001	0.05	0.10	1.0	3
2103	694	c	8.4	20	0.21	0.15	0.005	-	0.005	0.52	0.007	0.0001	0.02	0.01	0.79	3
3805	660	c	-	15	0.06	0.11	0.02	0.002	-	-	0.01	0.0001	0.04	-	-	1

\*c - coal  
o - oil

Table V-43

## ARSENIC CONCENTRATIONS IN ASH POND EFFLUENTS (23, 24)

<u>Station</u> <u>Location</u>	<u>Size</u> <u>(MW)</u>	<u>Ash Pond</u> <u>Type</u>	<u>Effluent</u> <u>Concentrations</u> <u>(ppb)<sup>a</sup></u>	<u>Plant Water</u> <u>Intake Conc.</u> <u>(ppb)</u>	<u>Data</u> <u>Sources</u>
Western W. Virginia	NA	Bottom	<5	NA	23
Eastern Ohio	NA	Bottom	7	NA	23
Southern Ohio	NA	Bottom	<5	NA	23
Eastern Michigan	NA	Bottom	30	NA	23
Southeast Michigan	NA	Fly	40	NA	23
Southeast Ohio	NA	Fly	200	NA	23
Eastern Missouri	NA	Bottom	20	NA	23
Central Utah	NA	Bottom	<5	NA	23
Western W. Virginia	NA	Fly	8	NA	23
Southern Ohio	NA	Fly	10	NA	23
Wyoming	750	Combined	<1	<1	24
Florida	948	Combined	9	3	24
Upper Appalachia	2900	Combined	74	<1	24

<sup>a</sup>Detection limit for NUS is 5 ppb/for Radian, 1 ppb.

NA - Not Available

## LOW VOLUME WASTES

Low volume wastes include boiler blowdown, waste streams from water treatment, and effluent from floor and yard drains.

### Boiler Blowdown

Power-plant boilers are either of the once-through or drum-type design. Once-through designs are used almost exclusively in high-pressure, supercritical boilers and have no wastewater streams directly associated with their operation. Drum-type boilers, on the other hand, operate at subcritical conditions where steam generated in the drum-type units is in equilibrium with boiler water. Boiler water impurities are, therefore, concentrated in the liquid phase. The concentration of impurities in drum-type boilers must not exceed certain limitations which are primarily a function of boiler operating conditions. Table V-44 presents recommended limits of total (dissolved and suspended) solids in drum-type boilers as a function of drum pressure (25). Boiler blowdown, therefore, serves to maintain specified limitations for dissolved and suspended solids. In response to the 308 questionnaire, 544 powerplants out of a total 794 indicated presence of boiler blowdown at their facilities.

The sources of impurities in the blowdown are the intake water, internal corrosion of the boiler, and chemicals added to the boiler system. Impurities contributed by the intake water are usually soluble inorganic species ( $\text{Na}^+$ ,  $\text{K}^+$ ,  $\text{Cl}^-$ ,  $\text{SO}_4^{2-}$ , etc) and precipitates containing calcium/magnesium cations. Products of boiler corrosion are soluble and insoluble species of iron, copper, and other metals. A number of chemicals are added to the boiler feedwater to control scale formation, corrosion, pH, and solids deposition. A summary of types of chemicals used for these purposes is presented in table V-45. In addition, the following proprietary chemicals which may contribute chromium, copper, and phenol species to the boiler blowdown were identified:

- NALCO 37 - contains chromium
- NALCO 75 - contains phenol
- NALCO 425L - contains copper
- CALGON CL35 - contains sodium dichromate

The boiler blowdown is usually of high quality and even may be of higher quality than the intake water. It is usually suitable for internal reuse in the powerplant, for example, as cooling water makeup (26, 27). Table V-46 presents a statistical analysis of regional EPA data on the quality of boiler blowdown. It should be noted that mean concentrations of phosphorous are computed on the basis of 19 data points. Phosphorous is evidently contributed by phosphate-containing chemicals used for solids deposition control. Under certain conditions, the concentrations of corrosion products such as copper and iron may be high. One power company in Southern California reported maximum concentrations of copper and iron as 2 and 20 ppm,

Table V-44

RECOMMENDED LIMITS OF TOTAL SOLIDS IN  
BOILER WATER FOR DRUM BOILERS (25)

<u>Drum Pressure</u>		<u>Total Solids (mg/l)</u>
<u>(atm)</u>	<u>(psi)</u>	
0-24.4	0-300	3500
20.41-30.5	301-450	3000
30.51-40.8	451-600	2500
40.18-51.0	601-750	2000
51.01-61.0	751-900	1500
61.01-68.0	901-1000	1250
68.01-102.0	1001-1500	1000
102-01-136	1501-2000	750
>136	>2000	15

Table V-45

CHEMICAL ADDITIVES COMMONLY ASSOCIATED WITH  
INTERNAL BOILER TREATMENT (25)

<u>Control Objective</u>	<u>Candidate Chemical Additives</u>	<u>Residual Concentration in Boiler Water</u>
	di- and tri-sodium phosphates	3-60 mg/l as PO <sub>4</sub> <sup>-</sup>
	Ethylene diaminetetracetic acid (EDTA)	20-100 mg/l
Scale	Nitrilotriacetic acid (NTA)	10-60 mg/l
	Alginates Polyacrylates Polymethacrylates	up to 50-100 mg/l
Corrosion	Sodium sulfite and catalyzed Sodium sulfite	less than 200 mg/l
	Hydrazine Morpholine	5-45 mg/l
pH	Sodium hydroxide Sodium carbonate Ammonia Morpholine Hydrazine	added to adjust boiler water pH to the desired level, typically 8.0 - 11.0
	Tannins Lignin derivatives	≤200 mg/l
Solids Deposition	Starch Alginates Polyacrylamides Polyacrylates Polymethacrylates Phosphates	20-50 mg/l

Table V-46

## STATISTICAL ANALYSIS OF BOILER BLOWDOWN CHARACTERISTICS

(Discharge Monitoring Data - EPA Regional Offices)

<u>Pollutants</u>	<u>Number of Points</u>	<u>Mean Concentration (mg/l)</u>	<u>Log. Mean</u>	<u>Standard Deviation</u>	<u>Log. Deviation</u>
Copper	258	.14	2.9615	.2888	1.2845
Iron	273	.53	2.3486	2.0609	1.6351
Oil & Grease	151	1.74	.0276	4.5311	.9807
Phosphorous	19	17.07	1.8363	12.5154	2.3911
Suspended	230	66.26	1.2198	500.3967	1.9421

respectively. These high values were observed immediately after boiler chemical cleaning (26)

Boiler blowdown may be discharged either intermittently or continuously. Table V-47 contains a statistical analysis of flow rates reported in the 308 responses from industry.

Three plants were sampled for boiler blowdown during the verification phase of the sampling program. The results are summarized in Table V-48. Pollutants not listed were not detected.

### Water Treatment

Boiler feedwater is treated for the removal of suspended and dissolved solids to prevent scale formation. The water treating processes include clarification, filtration, lime/lime soda softening, ion exchange, reverse osmosis, and evaporation.

#### Clarification

Clarification is the process of agglomerating the solids in a stream and separating them by settling. The solids are coagulated, by physical and chemical processes, to form larger particles and then allowed to settle. Clarified water is drawn off and may be filtered to remove any traces of turbidity (1). Chemicals commonly added to the clarification process are listed in table V-49. As the table shows, none of these chemicals contain any of the 129 priority pollutants. Table V-50 presents a statistical analysis of clarifier blowdown flow rates reported by the industry in response to the 308 questionnaires. Table V-51 presents a statistical analysis of filter backwash flow rates reported by the industry in response to the 308 questionnaires.

#### Ion Exchange

Ion exchange processes can be designed to remove all mineral salts in a one-unit operation and, as such, is the most common means of treating supply water. The ion exchange material is an organic resinous material manufactured in bead form. The resin may be one of two types: cation or anion. The ion exchange process generally occurs in a fixed bed of the resin beads which are electrically charged. The beads attract chemical ions of opposite charge. Once all of the available sites on the resin beads have been exhausted, the bed must be regenerated. During regeneration, the bed is backwashed (the normal flow throughout the bed is reversed), causing the bed to erupt and the solids to be released. A regenerant solution is then passed over the resin bed, for approximately 30 minutes for cation resins and 90 minutes for anion resins. The bed is then rinsed with water to wash the remaining voids within the bed.

The resulting exchange wastes are generally acidic or alkaline with the exception of sodium chloride solutions which are neutral. While these wastes do not have significant amounts of suspended solids,

Table V-47

## BOILER BLOWDOWN FLOWRATES

(308 questionnaire data)

<u>Variable</u>		<u>Number of Plants</u>	<u>Mean Value</u>	<u>Standard Deviation</u>	<u>Minimum Value</u>	<u>Maximum Value</u>
<u>Fuel. coal*</u>						
Flow	GPD/plant	231	33,259	71,682	0.11	650,000
	GPD/MW	230	148	392	-	3,717
<u>Fuel gas*</u>						
Flow	GPD/plant	189	19,346	60,933	4	700,000
	GPD/MW	189	163	669	0.08	8,470
<u>Fuel oil*</u>						
Flow	GPD/plant	148	66,173	320,106	2.7	3,810,000
	GPD/MW	148	287	1,237	0.12	14,066

---

\*Fuel designations are determined by the fuel which contributes the most Btu for power generation for the year 1975.



Table V-48

## SURVEILLANCE AND ANALYSIS DATA FOR BOILER BLOWDOWN

<u>Plant Code</u>	<u>Pollutant</u>	<u>Concentration (ppb)</u>	
		<u>Intake</u>	<u>Discharge</u>
1003	Chloroform	68	ND
	Dichlorobromomethane	23	ND
	Chlorodibromomethane	3.8	ND
	Arsenic, Total	3	2
	Copper, Total	9	8
	Mercury, Total	1	-----
	Zinc, Total	104	10
	Total Dissolved Solids	207,000	100,000
	Total Suspended Solids	2,800	800
	Oil and Grease	-----	5,000
	Total Organic Carbon	2,280	1,250
	Phenolics, 4AAP	D < 20	D < 20
	4203	1,1,2-Trichloroethane	0.23
Chloroform		4.4	0.12
Bromoform		0.07	ND
Dichlorobromomethane		0.87	ND
Chlorodibromomethane		0.17	ND
Phenol, GC/MS		4.2	6.4
Trichloroethylene		0.13	ND
Antimony, Total		ND < 1	6
Arsenic, Total		2	2
Cadmium, Total		4	5
Copper, Total		22	520
Lead, Total		ND < 20	40
Mercury, Total		1.5	1.7
Zinc, Total		10	68
Iron, Total		10	60

Table V-48 (Continued)

## SURVEILLANCE AND ANALYSIS DATA FOR BOILER BLOWDOWN

<u>Plant Code</u>	<u>Pollutant</u>	<u>Concentration (ppb)</u>	
		<u>Intake</u>	<u>Discharge</u>
2603	Benzene	D < 10	290
Unit #1	1,1,1-Trichloroethane	ND	D < 10
	1,1,2,2-Tetrachloroethane	ND	D < 10
	Chloroform	D < 10	D < 10
	1,1-Dichloroethylene	ND	60
	Ethylbenzene	ND	D < 10
	Methylene Chloride	D < 10	910
	Phenol, GC/MS	ND/9	ND/15
	Bis(2-Ethylhexyl) Phthalate	D < 10	D < 10
	Butyl Benzyl Phthalate	D < 10	ND
	Di-N-Butyl Phthalate	D < 10	D < 10
	Diethyl Phthalate	50	D < 10
	Tetrachloroethylene	D < 10	D < 10
	Toluene	ND	D < 10
	Trichloroethylene	D < 10	ND
	Antimony, Total	ND < 2	10
	Chromium, Total	10	6
	Copper, Total	22	26
	Lead, Total	ND < 20	36
	Mercury, Total	0.2	ND < 0.1
	Nickel, Total	8	1.3
	Selenium, Total	ND < 2	5.7
	Zinc, Total	88	72
	Total Dissolved Solids	292,000	11,000
	Total Suspended Solids	-----	D < 5,000
	Total Organic Carbon	9,000	D < 3,000
	Calcium, Total	48,700	D < 5,000
	Manganese, Total	65	ND < 5
	Magnesium, Total	15,300	ND < 1,000

Table V-48 (Continued)  
SURVEILLANCE AND ANALYSIS DATA FOR BOILER BLOWDOWN

<u>Plant Code</u>	<u>Pollutant</u>	<u>Concentration (ppb)</u>	
		<u>Intake</u>	<u>Discharge</u>
2603 Unit #1 (Cont'd)	Molybdenum, Total	ND < 5	61
	Sodium, Total	-----	D < 15,000
	Titanium, Total	18	ND < 5
	Iron, Total	842	-----
2603* Unit #2	Benzene		30
	1,1-Dichloroethylene		D < 10
	1,3-Dichloropropene		D < 10
	Ethylbenzene		D < 10
	Methylene Chloride		30
	Bromoform		D < 10
	Phenol, GC/MS		ND/10
	Di-N-Butyl Phthalate		D < 10
	Diethyl Phthalate		D < 10
	Tetrachloroethylene		D < 10
	Toluene		D < 10
	Antimony, Total		20
	Copper, Total		8
	Total Dissolved Solids		7,000
	Total Suspended Solids		D < 5,000
	Total Organic Carbon		3,000
	Aluminum, Total		213
	Calcium, Total		D < 5,000
	Molybdenum, Total		55
	Sodium, Total		D < 15,000

\*Intake data for Plant 2603, Unit #2 is the same as that for Plant 2603, Unit #1.

Table V-49

## COAGULATING AND FLOCCULATING AGENT CHARACTERISTICS (25)

<u>Coagulant/Flocculant</u>	<u>Purpose</u>	<u>Normal Dosage (mg/l)</u>
Alum $\text{Al}_2(\text{SO}_4)_3 \cdot 14 \text{H}_2\text{O}$	Main Coagulant To assist coagulation with aluminate	5-50 2-20
Aluminate $\text{Na}_2\text{Al}_2\text{O}_4$	Main Coagulant To assist coagulation with alum	5-15 (0.1 to 0.5 of alum dosage)
Ferric Chloride $\text{FeCl}_2 \cdot 6 \text{H}_2\text{O}$	Main Coagulant	5-50
Copperas $\text{FeSO}_4 \cdot 7 \text{H}_2\text{O}$	Main Coagulant	5-50
Weighting Agents (bentonite, kaolin, montmorillonite)	Coagulant Aid	-----
Absorbents (powdered carbon, activated alumina)	Coagulant Aid	-----
Polyelectrolytes (inorganic activated silica and organic polymers)	Coagulant Aid	$\leq 2$

Table V-50

## CLARIFIER BLOWDOWN FLOWRATES

(308 questionnaire data)

<u>Variable</u>		<u>Number of Plants</u>	<u>Mean Value</u>	<u>Standard Deviation</u>	<u>Minimum Value</u>	<u>Maximum Value</u>
<u>Fuel coal*</u>						
Flow	gpd/plant	88	29,966	74,518.4	7	605,000
	gpd/MW	87	64.8	200.9	0.04	1,208
<u>Fuel gas</u>						
Flow	gpd/plant	26	57,653	234,909	10	1,200,000
	gpd/MW	26	210.8	914	0.11	4,678
<u>Fuel oil</u>						
Flow	gpd/plant	14	19,779	29,820	20	100,420
	gpd/MW	14	107.9	196.8	0.15	697

\*Fuel designations are determined by the fuel which contributes the most Btu for power generation for the year 1975.

Table V-51

## FILTER BACKWASH FLOWRATES

(308 questionnaire data)

<u>Variable</u>		<u>Number of Plants</u>	<u>Mean Value</u>	<u>Standard Deviation</u>	<u>Minimum Value</u>	<u>Maximum Value</u>
<u>Fuel. coal*</u>						
Flow.	gpd/plant	155	25,460	42,027	1.6	300,000
	gpd/MW	154	71	258	0.013	2,400
<u>Fuel. gas*</u>						
Flow	gpd/plant	58	7,827	15,153	40	94,200
	gpd/MW	58	41	87	0.1	404
<u>Fuel oil*</u>						
Flow	gpd/plant	58	25,003	58,410	30	250,000
	gpd/MW	58	168	677	0.13	4,528

---

\*Fuel designations are determined by the fuel which contributes the most Btu for power generation in the year 1975.

certain chemicals such as calcium sulfate and calcium carbonate have extremely low solubilities and are often precipitated because of common ion effects

The wastes may be collected in an equalization tank or basin and neutralized with acid or alkali or slowly mixed with other nonprocess wastes prior to treatment. In the cases where the wastes are mixed with other non-process water, there may be the effect of neutralization by the natural alkalinity or acidity of the non-process stream. In any of the treatment cases discussed above, the treated water is suitable for reuse as non-process makeup water.

Spent regenerant solutions, constituting a significant part of the total flow of wastewater from ion exchange regeneration, contains ions which are eluted from the ion exchange material plus the excess regenerant that is not consumed during regeneration. The eluted ions represent the chemical species which were removed from water during the service cycle of the process. Table V-52 presents a summary of ion exchange material types and regenerant requirements of each. Historical raw waste load data for ion exchange regenerant is shown in table V-53. Table V-54 contains a statistical analysis of ion exchange spent regenerant flow rates reported in the industry response to the 308 questionnaire.

#### Lime/Lime Soda Softening

In lime softening, chemical precipitation is applied to hardness and alkalinity. Calcium precipitates as calcium carbonate ( $\text{CaCO}_3$ ) and magnesium as magnesium hydroxide ( $\text{Mg}(\text{OH})_2$ ). The softening may take place at ambient temperatures, known as cold process softening, or at elevated temperatures (100 C or 212 F), known as hot process softening (1). The hot process accelerates the formation of the carbonates and hydroxides. Hot process softening is commonly employed for treating boiler feed water in facilities where steam is generated for heating processes as well as electric power generation. Since lime and/or soda ash are the only chemicals added in this process, none of the priority pollutants will be introduced in the system. Table V-55 presents a statistical analysis of lime softener blowdown flow rates reported by the industry in response to the 308 questionnaires.

#### Evaporator Blowdown

Evaporation is a process of purifying water by vaporizing it with a heat source and condensing the vaporized water. The influent water evaporates and is ducted to an external product condenser. In the lower portion of the evaporator, a pool of boiling water is maintained at a constant level to keep the heat source (steam tubes) immersed in liquid. Water is periodically blown down from the bottom to lower the contaminant levels. Table V-56 presents historical raw waste load data for the evaporator blowdown. As indicated in this table, suspended solids in the blowdown may reach very high levels. Table V-57 presents a statistical analysis of evaporator blowdown flow rates reported by the industry in response to the 308 questionnaires.

Table V-52

## ION EXCHANGE MATERIAL TYPES AND REGENERANT REQUIREMENT (25)

<u>Ion Exchange Material</u>	<u>Description of Operation</u>	<u>Regenerant Solution</u>	<u>Regenerant Requirement Theoretical Amount</u>
Cation Exchange Sodium Cycle	Sodium cycle ion exchange is used as a water softening process. Calcium, magnesium, and other divalent cations are exchange for more soluble sodium cations, i.e.,  $2R_C - Na + Ca^{+2} \quad (R_C)_2 - Ca + 2 Na^+$ $2R_C - Na - Mg^{+2} \quad (R_C)_2 - Mg + 2 Na^+$	10% brine (NaCl) solution or some other solution with a relatively high sodium content such as sea water.	-----
Hydrogen Cycle Weak Acid	Weak acid ion exchange removes cations from water in quantities equivalent to the total alkalinity present in the water, i.e.,  $2R_C - H + Ca(HCO_3)_2 \quad (R_C)_2 - Ca + 2 H_2CO_3$	H <sub>2</sub> SO <sub>4</sub> or HCl solutions with acid strengths as low as 0.5%	110-120%
Strong Acid	Strong acid ion exchange removes cations of <u>all</u> soluble salts in water, i.e.,  $R_C - H NaCl \quad R_C - Na + HCl$	H <sub>2</sub> SO <sub>4</sub> or HCl solutions with acid strengths ranging from 2.0-6.0%	200-400%
Anion Exchange Weak Base	Weak base ion exchange removes anions of all strong mineral acids (H <sub>2</sub> SO <sub>4</sub> , HCl, HNO <sub>3</sub> , etc.), i.e.,  $2R_A - OH + H_2SO_4 \quad (R_A)_2 - SO_4 + 2HOH$	NaOH, NH <sub>4</sub> OH, Na <sub>2</sub> CO <sub>3</sub> solutions of variable strength	120-140%
Strong Base	Strong base ion exchange removes anions of <u>all</u> soluble salts in water i.e.,  $R_A - OH + H_2CO_3 \quad R_A - HCO_3 + HOH$	NaOH solutions at approximate 4.0% strength.	150-300%



Table V-53

ION EXCHANGE SPENT REGENERANT CHARACTERISTICS  
(Discharge Monitoring Data - EPA Regional Offices)

<u>Pollutant</u>	<u>Mean Value</u>	<u>Standard Deviation</u>	<u>Minimum Value</u>	<u>Maximum Value</u>
pH (122 entries)	6.15	2.45	1.7	10.6
Suspended solids (mg/l) (88 entries)	44	60.14	3.0	305
Dissolved solids (mg/l) (39 entries)	6,057	2,435	1,894	9,645
Oil and Grease (mg/l) (29 entries)	6.0	6.7	0.13	22

Table V-54

## ION EXCHANGE SOFTENER SPENT REGENERANT FLOWRATES

(308 Questionnaire Data)

<u>Variable</u>		<u>Number of Plants</u>	<u>Mean Value</u>	<u>Standard Deviation</u>	<u>Minimum Value</u>	<u>Maximum Value</u>
<u>Fuel coal*</u>						
Flow	gpd/plant	104	9,290	16,737	14.4	107,143
	gpd/MW	104	79	264	0.12	2,028
<u>Fuel gas*</u>						
Flow	gpd/plant	86	11,142	32,663	7	164,000
	gpd/MW	86	84	247	0.12	2,058
<u>Fuel oil*</u>						
Flow	gpd/plant	42	19,358	32,965	16	132,000
	gpd/MW	42	226	764	0.43	4,633

---

\*Fuel designations are determined by the fuel which contributes the most Btu for power generation in the year 1975.

Table V-55

## LIME SOFTENER BLOWDOWN FLOWRATES

(308 Questionnaire Data)

<u>Variable</u>		<u>Number of Plants</u>	<u>Mean Value</u>	<u>Standard Deviation</u>	<u>Minimum Value</u>	<u>Maximum Value</u>
<u>Fuel coal*</u>						
Flow	gpd/plant	37	26,228	85,069	29	50,000
	gpd/MW	37	56	117	0.28	625
<u>Fuel gas*</u>						
Flow	gpd/plant	40	30,937	144,642	15	900,000
	gpd/MW	40	154	558	0.17	3,508
<u>Fuel oil*</u>						
Flow	gpd/plant	15	15,808	57,099	75	222,180
	gpd/MW	15	216	818	0.62	3,174

---

\*Fuel designations are determined by the fuel which contributes the most Btu for power generation in the year 1975.

Table V-56

## EVAPORATOR BLOWDOWN CHARACTERISTICS

(Discharge Monitoring Data - EPA Regional Offices)

<u>Pollutants</u>	<u>Number of Points</u>	<u>Mean Concentration (mg/l)</u>	<u>Log. Mean</u>	<u>Standard Deviation</u>	<u>Log. Deviation</u>
Copper	9	.39	-.9671	.0875	.2080
Iron	9	.54	-.6198	.0831	.1543
Oil & Grease	9	2.1	.7085	.4841	.2404
Suspended Solids	31	28.4	2.4499	36.7079	1.5392

Table V-57

## EVAPORATOR BLOWDOWN FLOWRATES

(308 Questionnaire Data)

<u>Variable</u>		<u>Number of Plants</u>	<u>Mean Value</u>	<u>Standard Deviation</u>	<u>Minimum Value</u>	<u>Maximum Value</u>
<u>Fuel. coal*</u>						
Flow	gpd/plant	104	29,310	96,221	2	962,800
	gpd/MW	104	126	810	-	8,292
<u>Fuel. gas*</u>						
Flow	gpd/plant	83	13,647	34,312	8	215,000
	gpd/MW	83	74	222	0.02	1,512
<u>Fuel oil*</u>						
Flow	gpd/plant	57	320,293	2,111,836	15	15,900,000
	gpd/MW	57	4,781	34,796	0.11	262,809

\*Fuel designation are determined by the fuel which contributes the most Btu for power generation in the year 1975

## Reverse Osmosis

Reverse osmosis is a process in which a semipermeable membrane--generally cellulose acetate or a polyamide--separates two solutions of different concentrations. In the case of a salt solution, use of a membrane impermeable to salt will allow only water to leave the solution, producing one stream with a greater salt concentration than the feed and one, more dilute. The concentrated stream is called the reverse osmosis brine and constitutes the waste stream from the process. Table V-58 presents a statistical analysis of reverse osmosis brine flow rates reported by the industry in response to the 308 questionnaires. In the water treatment schemes reported by the industry, reverse osmosis was always used in conjunction with demineralizers and sometimes in conjunction with clarification, filtration, and ion exchange softening.

## Drains and Spills

### Floor and Yard Drains

There are numerous sources of wastewater in the nature of piping and equipment drainage and leakage throughout a steam electric facility. The list in table V-59 is a representative compilation of the sources, showing major contaminants, the likelihood of occurrence, potential severity, and control techniques which might be employed. There have been no data reported for this stream, however, the pollutant parameters which may be of concern would be oil and grease, pH, and suspended solids.

### Laboratory Streams

Many steam electric powerplants maintain laboratory facilities to carry out chemical analyses as a part of controlling the operation of the plant. This would include elemental analysis and heating value analysis of coal, analysis of treated boiler water, and boiler tube cleaning chemical analysis.

The wastes from the laboratories vary in quantity and constituents, depending on the use of the facilities and the type of powerplant. The chemicals are usually present in extremely small quantities. It has been common practice to combine laboratory drains with other plant plumbing.

## Sampling Results

Demineralizer regenerants were sampled in three facilities during the verification phase of the sampling program. Analytical results are presented in Table V-60.

## METAL CLEANING WASTES

Metal cleaning wastes include wastewater from chemical cleaning of boiler tubes, air preheater washwater, and boiler fireside washwater.

Table V-58

REVERSE OSMOSIS BRINE FLOWRATES

(308 Questionnaire Data)

<u>Variable</u>		<u>Number of Plants</u>	<u>Mean Value</u>	<u>Standard Deviation</u>	<u>Minimum Value</u>	<u>Maximum Value</u>
<u>Fuel. coal*</u>						
Flow	gpd/plant	3	10,674	18,192	3	31,680
	gpd/MW	3	31	53	0.25	92
<u>Fuel. gas*</u>						
Flow	gpd/plant	11	18,179	27,437	465	95,000
	gpd/MW	11	55	42	23	165

---

\*Fuel designations are determined by the fuel which contributes the most Btu for power generation in the year 1975.

Table V-59

## EQUIPMENT DRAINAGE AND LEAKAGE (1)

<u>Source</u>	<u>Major Contaminants</u>	<u>Frequency</u>	<u>Potential Severity</u>	<u>Potential Control Techniques</u>
Oil-water Heat Exchangers	Oil	Remote Possibility	Severe	<ol style="list-style-type: none"> <li>1. Continuous Gravity Separation</li> <li>2. Detection and Batch Gravity Separation</li> <li>3. Detection &amp; Mechanical Separation</li> <li>4. Maintain pressure of water greater than oil</li> </ol>
Oil Tank, Lines & Transformer Rupture	Oil	Remote Possibility	Severe	<ol style="list-style-type: none"> <li>1. Isolation from Drains</li> <li>2. Containment of Drainage</li> </ol>
Floor Spills	Suspended Solids or Oil	Daily	Slight	<ol style="list-style-type: none"> <li>1 Plug Floor Drain</li> <li>2 Route Floor Drainage Through Clarifier &amp; Gravity or Mechanical Separation</li> </ol>
Oil Drips and Tank Leakage	Oil	Daily	Slight	<ol style="list-style-type: none"> <li>1 Isolate from Floor Drains</li> <li>2 Route to Gravity or Mechanical Separation</li> </ol>
Sump Discharges from Service Bldg & Yard	Oil and Suspended Solids	Often	Slight	<ol style="list-style-type: none"> <li>1. Isolate and route clarifier and gravity or mechanical separation</li> </ol>
Chemical Tank Rupture	Regenerant and cleaning chemicals	Remote Possibility	Severe	<ol style="list-style-type: none"> <li>1 Containment of Drainage</li> <li>2 Isolation from Drains</li> <li>3. Route drains to Ash Pond or Holding Pond for Neutralization</li> </ol>
Chemical Tank Leakage	Regenerant and cleaning chemicals	Occasional	Slight	<ol style="list-style-type: none"> <li>1. Isolate from Floor Drains</li> <li>2. Route drains to Ash Pond or Holding Pond</li> </ol>

NOTE Oil Spill Contingency Plans would apply to significant oil releases.



Table V-60

## SURVEILLANCE AND ANALYSIS DATA FOR DEMINERALIZER REGENERANT

Plant Code	Pollutant	Concentration (ppb)	
		Intake	Discharge
1003	1,1,1-Trichloroethane	ND	2
	Chloroform	68	1.8
	Bromoform	23	-----
	Dichlorofluoromethane	3.8	-----
	Arsenic, Total	3	-----
	Copper, Total	9	-----
	Mercury, Total	1	-----
	Selenium, Total	1	-----
	Zinc, Total	104	-----
	Total Dissolved Solids	207,000	4,584,000
	Total Suspended Solids	2,800	9,250
	Total Organic Carbon	2,280	4,810
	4203	Chlorobenzene	ND
1,1,2-Trichloroethane		0.23	0.68
Chloroform		4.4	38
1,2-Dichlorobenzene		ND	39
1,3-Dichlorobenzene		ND	0.3
1,4-Dichlorobenzene		ND	5.2
Methylene Chloride		ND	>220
Bromoform		0.07	ND
Dichlorobromomethane		0.87	ND
Chlorodibromomethane		0.17	ND
Nitrobenzene		ND	81
Phenol, GC/MS		4.2	3.8
Di-N-Octyl Phthalate		ND	22
Trichloroethylene		0.13	0.38
Arsenic, Total		2	-----
Cadmium, Total		4	35
Chromium, Total		ND<2	26

Table V-60 (Continued)

## SURVEILLANCE AND ANALYSIS DATA FOR DEMINERALIZER REGENERANT

Plant Code	Pollutant	Concentration (ppb)	
		Intake	Discharge
4203 (Cont'd)	Copper, Total	22	65
	Cyanide, Total	0	0.04
	Lead, Total	ND<20	24
	Mercury, Total	1.5	1.6
	Nickel, Total	ND<20	230
	Silver, Total	ND<2	58
	Zinc, Total	10	54
	Iron, Total	10	5,000
	Acetone	-----	8.7
	2603	Benzene	D<10
Chloroform		ND<10	140
1,1-Dichloroethylene		ND	D<10
Methylene Chloride		D<10	60
Bromoform		ND	D<10
Dichlorobromomethane		ND	70
Chlorodibromomethane		ND	30
Phenol, GC/MS		ND/9	ND/4
Bis(2-Ethylhexyl) Phthalate		D<10	D<10
Butyl Benzyl Phthalate		D<10	-----
Di-N-Butyl Phthalate		D<10	D<10
Diethyl Phthalate		50	D<10
Tetrachloroethylene		D<10	D<10
Trichloroethylene		D<10	ND
Antimony, Total		ND<2	20
Cadmium, Total		ND<2	5
Chromium, Total		10	14
Copper, Total		22	27
Cyanide, Total		ND<5	47
Mercury, Total		0.2	6

Table V-60 (Continued)

## SURVEILLANCE AND ANALYSIS DATA FOR DEMINERALIZER REGENERANT

<u>Plant Code</u>	<u>Pollutant</u>	<u>Concentration (ppb)</u>	
		<u>Intake</u>	<u>Discharge</u>
2603 (Cont'd)	Nickel, Total	8	200
	Selenium, Total	ND<2	4
	Thallium, Total	ND<20	182
	Zinc, Total	88	ND
	Total Dissolved Solids	292,000	3,010,000
	Total Suspended Solids	-----	17,000
	Total Organic Carbon	9,000	8,000
	Aluminum, Total	497	277
	Barium, Total	17	ND<5
	Boron, Total	ND<50	63
	Calcium, Total	48,700	169,000
	Manganese, Total	65	9
	Magnesium, Total	15,300	17,400
	Molybdenum, Total	ND<5	15
	Sodium, Total	-----	159,000
	Titanium, Total	18	ND<15
	Iron, Total	842	793

## Chemical Cleaning of Boiler Tubes

Chemical cleaning is designed to remove scale and corrosion products which accumulate on the boiler tubes in the boiler's steam-side. There are a number of factors affecting the selection of the cleaning method. Among the major factors are:

1. Type of deposit,
2. Type of metals (alloys) cleaned,
3. Type of boiler,
4. Economics,
5. Prior experience,
6. Hazards associated with cleaning agents, and
7. Ease of waste disposal.

### Boiler Cleaning Chemicals

Hydrochloric Acid Without Copper Complexer Hydrochloric acid is the most frequently used boiler tube cleaning chemical. It has the ability to handle a wider range of deposits than any other solvent available today. This ability, combined with its relatively low cost, availability, and the extensive experience associated with its use for boiler cleanings, is the reason for its popularity in the chemical cleaning of utility boilers (28).

Hydrochloric acid, which is usually used in solutions of 5 to 10 percent, forms soluble chlorides with the scale and corrosion products in the boiler tubes. Its strength makes it very effective for removing heavy deposits; however, due to this strength, an inhibitor is mandatory to reduce attack to boiler tube metal. This strength also allows the use of either the soaking or circulation method of boiler cleaning.

The high chloride content makes the use of hydrochloric acid solutions infeasible for austenitic steels due to the potential for chloride stress cracking (29). Hydrochloric acid is highly corrosive. Hydrogen gas will be liberated during cleaning operations. Large amounts of water are required for rinsing.

Hydrochloric Acid With Copper Complexer Hydrochloric acid with a copper complexer is used in boilers containing copper to prevent the replating of dissolved copper onto steel surfaces during chemical cleaning operations. The two most prominent complexers are Dow Chemical's Thiourea and Halliburton's Curtain II. If a complexer is not used, copper chlorides, formed during cleaning operation, react with boiler tube iron to form soluble iron chlorides while the copper

is replated onto the tube surface. Use of a copper complexer interrupts this reaction by complexing the copper (30,31).

Alkaline Degreaser Alkaline cleaning (flush/boil-out) is commonly employed prior to boiler cleaning to remove oil-based compounds from tube surfaces. These solutions are composed of trisodium phosphate and a surfactant and act to clear away the materials which may interfere with the reactions of the boiler cleaning chemicals and deposits (32, 33).

Ammoniated Citric Acid Citric acid cleaning solutions are used by a number of utilities for boiler cleaning operations (34). Utilizing the circulation method, this weak acid is usually diluted to a 3 percent solution and ammoniated to a pH of 3.5 for cleaning purposes. This solution is used in a two-stage process. The first stage involves the dissolution of iron oxides. In the second stage, anhydrous ammonia is added to a pH of 9 to 10 and air is bubbled through the solution to dissolve copper deposits. Halliburton markets this as the Citrosolv Process (35). This "one solution" cleaning process affords some advantages due to the minimal cleaning time and water requirements. The hazards associated with this solution are not as great as with other acids due to its lower corrosivity; however, there is potential for hydrogen gas liberation.

Ammoniated EDTA The most widely known ammoniated EDTA cleaning chemical is produced by Dow Chemical Company and marketed under the name, "Vertan 675". This boiler cleaning agent has been used successfully in a wide variety of boiler cleaning operations. The cleaning involves a one solution, two-stage process. During the first stage, the solution solubilizes iron deposits and chelates the iron solution. In the second stage, the solution is oxidized with air to induce iron chelates from ferric to ferrous and to oxidize copper deposits into solution where the copper is chelated (36).

The most prominent use of this cleaning agent is in circulating boilers which contain copper alloys. It has gained increasing popularity for use in cleaning utility boilers due to its low hazard (no hydrogen gas formation and not highly corrosive) and low water usage (normally only one rinse required).

Ammonical Sodium Bromate Occasionally, large amounts of copper deposits in boiler tubes cannot be removed with hydrochloric acid due to copper's relative insolubility. When such conditions exist, solutions of ammonia-based oxidizing compounds have been effective. Used in a single separate stage the ammonical sodium bromate step includes the introduction of solutions containing ammonium bromate into the boiler system to rapidly oxidize and dissolve the copper. This stage may be completed pre- or post-acid stage. It has been found to be effective on units which contain large amounts of copper metals (37).

Hydroxyacetic/Formic Acid The use of hydroxyacetic/formic acid in the chemical cleaning of utility boilers is common. It is used in

boilers containing austenitic steels because its low chloride content prevents possible chloride stress corrosion cracking of the austenitic-type alloys. It has also found extensive use in the cleaning operations for once-through supercritical boilers (38) Circulation of this solvent is required in order to keep desired strength in all areas of the boiler system. Hydroxyacetic/formic acid has chelation properties and a high iron pick-up capability, thus it is used on high iron content systems. It is not effective on hardness scales. If water requirements are low, generally only one rinse is required. The corrosiveness of the solvent is not as high as that of inorganic acids, yet there is potential for hydrogen gas release

Sulfuric Acid. Sulfuric acid has found limited use in boiler cleaning operations. It is not feasible for removal of hardness scales due to the formation of highly insoluble calcium sulfate (39) It has found some use in cases where a high-strength, low-chloride solvent is necessary. As with other acids, potential hazards involve the liberation of hydrogen gas and the chemical's highly corrosive nature. Use of sulfuric acid requires high water usage in order to rinse the boiler sufficiently

#### Waste Characteristics

The characteristics of waste streams emanating from the chemical cleaning of utility boilers are similar in many respects. The major constituents consist of boiler metals; i.e., alloy metals used for boiler tubes, hot wells, pumps, etc. Although waste streams from certain cleaning operations which are used to remove certain deposits, i.e., alkaline degreaser to remove oils and organics; do not contain heavy concentrations of metals, the primary purpose of the total boiler cleaning operation (all stages combined) is removal of heat transfer-retarding deposits, which consist mainly of iron oxides resulting from corrosion. This removal of iron is evident in all total boiler cleaning operations through its presence in boiler cleaning wastes.

Copper is the next most prevalent constituent of boiler cleaning wastes due to wide use as a boiler system metal. Based on information on nearly 2,500 utility boilers, EPA estimates that copper alloys are used in 91 percent of the steam condenser tubes, 85 percent of the highpressure feedwater heater tubes, and 83 percent of the lowpressure feedwater heater tubes (40). Table V-61 shows a few of these alloys and corresponding constituents.

The presence of boiler metal constituents in chemical cleaning wastes is further illustrated by examining the characteristics of wastes emanating from boilers in which admiralty metals were used for steam condenser tubes and low-pressure feedwater heater tubes. Admiralty metal contains approximately 25 percent zinc.

The wastewaters from a boiler cleaning operation on a boiler containing such an alloy contained 166 mg/l of zinc. The relatively

Table V-61  
 ALLOYS AND CONSTITUENTS OF BOILER SYSTEMS (41)  
 (Percent)

<u>Alloy</u>	<u>Constituent</u>				
	<u>Copper</u>	<u>Iron</u>	<u>Nickel</u>	<u>Zinc</u>	<u>Other</u>
Admiralty	71			25	Sn-4
Arsenical Admiralty	71			27	As-0.04
Phosphorized Admiralty	71			27	P-0.1
Brass	65			35	
Aluminum brass	65			30	Al-5
Copper-nickel 90/10	90		10		
Copper-nickel 80/20	80		20		
Copper-nickel 70/30	70		30		
Cupro-nickel (10%)	89	1.0	10		
Cupro-nickel (20%)	79	1.0	20		
Monel	23	3.5	60		Mn-3.5

high value of zinc was due to the presence of zinc in the boiler tube metal (1).

A number of cleaning agents use complexing agents in order to keep dissolved deposits in solution and thus remove them from the boiler system when the solution is drained. Ammoniated solutions of bromate, citrate, and EDTA have been used for this purpose. Ammonia forms a complex with copper while citrate and EDTA chelate iron and other heavy metals. Ammonia is a monodentate complex former since it contains only one ligand. Citrate and EDTA are multidentate complex formers. Multidentate complexes may be referred to as chelates, whereas monodentate complexes are referred to only as complexers (42). These complexes and chelates are stable compounds and pose greater difficulty in treatment.

Other waste constituents present in spent chemical cleaning solutions include wide ranges of pH, high dissolved solids concentrations, and significant oxygen demands (BOD and/or COD). The pH of spent solutions ranges from 2.5 to 11.0 depending on whether acidic or alkaline cleaning agents are employed.

Waste characteristics for the above mentioned cleaning solutions appear in tables V-62 through V-67. A brief description of those wastes by chemical cleaning solvent type follows.

Alkaline Degreaser. Alkaline cleaning is used to remove oil contaminants which may have entered the boiler system. The cleaning solution waste will contain sodium phosphates, and some boiler metals. In some cases, if chelating agents and sodium hydroxide have been added to the original cleaning solution, these materials and related compounds may be present. Volume of waste solutions will exceed two boiler volumes due to intermittent blowdowns and a final rinse with condensate.

Ammoniated Citric Acid This waste stream consists of a number of complexed boiler metals. Their presence is dependent upon their use in boiler metals alloys. Citrate, a multidentate ligand, is the chelating agent in this solution, while ammonia forms soluble complexes with copper. Various other constituents of this waste stream will include dissolved deposit components and BOD. Waste volume is generally equivalent to two boiler volumes, which includes a rinse.

Ammoniated EDTA. Ammoniated EDTA wastes are alkaline (pH = 9.0 to 10.0) and contain amounts of iron and copper which are present as ferric and cupric chelates. Although this type of cleaning agent is used generally for removal of copper, the copper content will vary in concentration in proportion to the amount of copper used in the boiler system. Similarly, the content of other boiler metals present in the waste will generally be a function of their presence. The volume of waste from this type of cleaning is usually two boiler volumes. One volume consists of the cleaning solution while the second will be rinse water.



Table V-62

WASTE CONSTITUENTS OF AMMONIATED CITRIC ACID SOLUTIONS (48)  
(mg/l)

<u>CONSTITUENTS</u>	<u>C-1</u>	<u>C-2</u>	<u>C-3</u>
Silica		40	
Phosphorous		200	
Copper	220	20	8
Iron	8,300	9,800	10,800
Nickel	130		
Zinc	390		

- NOTE (1) The absence of concentration value denotes information is not available.
- (2) C-1, C-2, C-3 denote wastes from independent boiler chemical cleaning operations.

Table V-63

WASTE CONSTITUENTS OF AMMONIATED EDTA SOLUTIONS (48)  
(mg/l)

<u>CONSTITUENTS</u>	<u>V-1</u>	<u>V-2</u>	<u>V-3</u>	<u>V-4</u>	<u>V-5</u>	<u>V-6</u>	<u>V-7</u>
Waste Volume, million gallons						19,000	
pH, units	9.2	8.8	9.0	9.5	9.5	9.2	10.0
Dissolved Solids						59,549	73,800
Suspended Solids							24
Oil & Grease							41
Silica					93.69		
NH3 - N							5,200
Phosphorous					260.25		
Aluminum					31.23		
Calcium					20.82	45.3	
Chromium					10.41	26.50	11.6
Copper	11,700	30	53	413	124.92	707	0.17
Iron	2,250	4,600	7,900	7,000	8,328	6,867	6,900
Magnesium					20.82	11.12	
Manganese					72.87	49.93	
Nickel					135.33	68.40	11.8
Sodium						371.87	
Zinc					124.92	143.75	79

- NOTE (1) The absence of concentration value denotes information is not available.
- (2) V-1 through V-7 denote wastes from independent boiler chemical cleaning operations.

Table V-64

WASTE CONSTITUENTS OF AMMONIACAL SODIUM BROMATE SOLUTIONS (48)  
(mg/l)

<u>CONSTITUENTS</u>	<u>AB-1</u>	<u>AB-2</u>	<u>AB-3</u>	<u>AB-4</u>	<u>AB-5</u>	<u>AB-6</u>
Waste Volume, million gallons					0.217	0.165
pH, units		10.5	10.2			
Dissolved Solids			1,015		340	1,400
Suspended Solids			77		8	71
COD					24	120
Oil & Grease					<5	<5
Silica					7.2	14
NH <sub>3</sub> - N					700	2,000
Org. - N					40	<10
NO <sub>2</sub> + NO <sub>3</sub> - N					0.04	0.51
Phosphorous					10	30
Bromide					52	<5
Chloride					60	
Fluoride					1.5	6.1
Aluminum					<0.2	<0.2
Arsenic	307				0.048	<0.005
Barium					<0.1	<0.1
Beryllium					<0.01	<0.01
Cadmium	<0.02				<0.001	<0.001
Calcium			0.0		3.0	0.4

Table V-64 (Continued)

WASTE CONSTITUENTS OF AMMONIACAL SODIUM BROMATE SOLUTIONS (48)  
(mg/l)

<u>CONSTITUENTS</u>	<u>AB-1</u>	<u>AB-2</u>	<u>AB-3</u>	<u>AB-4</u>	<u>AB-5</u>	<u>AB-6</u>
Chromium	<0.05		0.0		<0.005	<0.005
Copper	409	750	117	334	100	790
Iron	1.92		0.15	0	1.7	4.9
Lead	0.1				<0.01	<0.01
Magnesium			0.0		2.9	0.67
Manganese			0.01		0.03	0.04
Mercury	14.9				<0.0002	<0.0002
Nickel	255		0.08	0	0.52	2.5
Potassium					70	220
Selenium	23.6				<0.002	<0.002
Silver					<0.01	<0.02
Sodium			59		3.7	15
Tin					<1	<1
Zinc	1.03		0.41	0.5	0.06	0.54

- NOTE (1) The absence of concentration value denotes information is not available.
- (2) AB-1 through AB-6 denote wastes from independent boiler chemical cleaning operations.

Table V-65

WASTE CONSTITUENTS OF HYDROCHLORIC ACID WITHOUT COPPER COMPLEXER SOLUTIONS (48)  
(mg/l)

<u>CONSTITUENTS</u>	<u>H-1</u>	<u>H-2</u>	<u>H-3</u>	<u>H-4</u>	<u>H-5</u>	<u>H-6</u>	<u>H-7</u>
Waste Volume, million gallons	0.200	0.217	0.099	0.087	0.070	0.090	
pH, units	3.3	0.8	0.7	0.7	0.5	0.7	
Suspended Solids	57	8	120	18	35	33	
COD	9,900	1,200	1,500	1,200	1,900	1,500	
TOC	4,600	240	90	1,800	220	120	
Oil & Grease	23	<5	11	7.6	20	23	
Phenols	0.05	0.065	0.070	0.035	0.020	0.025	
Silica	19	66	120	240	31		
NH <sub>3</sub> - N	325	140	80	220	290	150	
Org. - N	225	0.06	140	75	10	870	
NO <sub>2</sub> + NO <sub>3</sub> - N		0.07	<0.01	<0.01	<0.01		
Phosphorous	1.2	30	50	35	50	45	
Sulfate		<1	10	<1	<1		
Aluminum		6.5	6.6	7.0	8.2		
Arsenic	0.008	0.06	0.01	0.03	0.055	0.035	
Barium		<0.1	0.4	0.1	0.3		
Beryllium		<0.01	<0.01	<0.01	<0.01		
Cadmium	<0.001	<0.01	0.051	0.032	0.1	<0.001	
Calcium	16	42	70	53	64	74	

Table V-65 (Continued)

WASTE CONSTITUENTS OF HYDROCHLORIC ACID WITHOUT COPPER COMPLEXER SOLUTIONS (48)  
(mg/l)

<u>CONSTITUENTS</u>	<u>H-1</u>	<u>H-2</u>	<u>H-3</u>	<u>H-4</u>	<u>H-5</u>	<u>H-6</u>	<u>H-7</u>
Chromium		<0.005	1.5	6	1.1	8.8	<0.005
Copper	43	0.69	2.2	7.6	18	13	47
Iron	1,125	4,200	1,300	3,820	1,420	3,720	2,780
Lead			0.4	3.8	0.86	5.2	<0.01
Magnesium			8.7	6.5	5.7	8.8	
Manganese		19	6.9	29	10	28	22
Mercury			<0.002	<0.002	<0.002	<0.002	
Nickel	150	110	77	260	170	300	150
Potassium			1.4	2.3	1.5	1.8	
Selenium			<0.004	<0.002	<0.002	<0.002	
Silver			0.02	0.02	0.07	0.03	
Sodium			31	74	40	49	
Tin			<1	7.3	<1	2.8	
Zinc	15.8	0.94	5.9	170	34	53	24

- NOTE (1) The absence of concentration value denotes information is not available.
- (2) H-1 through H-7 denote wastes from independent boiler chemical cleaning operations.

Table V-66

WASTE CONSTITUENTS OF HYDROCHLORIC ACID WITH COPPER COMPLEXER SOLUTIONS (48)  
(mg/l)

<u>CONSTITUENTS</u>	<u>HC-1</u>	<u>HC-2</u>	<u>HC-3</u>	<u>HC-4</u>	<u>HC-5</u>	<u>HC-6</u>
Dissolved Solids						
Suspended Solids						30,980
Silica	280	30				2,375
Phosphorous	100	300				
Calcium						
Chromium					980	66.6
Copper	20	460	110	960		16.8
Iron	4,600	1,900	2,100	3,200	270	530
Manganese					6,200	6,470
Nickel	3	410	20	500		8.16
Sodium						267
Zinc		680	10	840		9.2
						132

- NOTE (1) The absence of concentration values denotes information is not available.
- (2) HC-1 through HC-6 denote wastes from independent boiler chemical cleaning operations.

Table V-67

WASTE CONSTITUENTS OF HYDROXYACETIC/FORMIC ACID SOLUTIONS (48)  
(mg/l)

<u>CONSTITUENTS</u>	<u>HFA-1</u>	<u>HFA-2</u>	<u>HFA-3</u>	<u>HFA-4</u>
Copper				2
Iron	9,800	3,600	6,300	2,900
Nickel				5
Zinc				8

- NOTE (1) The absence of concentration value denotes information is not available.  
 (2) HFA-1 through HFA-4 denote wastes from independent boiler chemical cleaning operations.



Ammoniacal Sodium Bromate Ammoniated sodium bromate solutions are used to remove large amounts of copper from boiler systems. Nitrogen compounds will be present in large quantities due to the ammonia. This cleaning step is followed by a rinse which makes the volume of this chemical cleaning waste equivalent to two boiler volumes.

Hydrochloric Acid Without Copper Complexer These wastes are generally high in total iron concentration (100 mg/l), low in total copper (100 mg/l) and vary with low to medium concentrations of nickel and zinc, depending on boiler metal alloys. Other significant constituents of this type of waste stream consist of solubilized deposit materials, such as calcium, silica, phosphorous, and oil and grease. Some rather low quantities of arsenic, cadmium, chromium, manganese, and tin are also present due to slight acidic attack on boiler metals. The volume of wastes associated with this type of cleaning is generally four times the boiler capacity. This accounts for rinses and neutralization steps in addition to the acid cleaning step.

Hydrochloric Acid With Copper Complexer The use of the copper complexer implies that copper is present in the system as a boiler metal and therefore must be removed to prevent replating onto steel surfaces. This copper is present as a complex, as are the concentrations of nickel and zinc which are present mainly at moderate levels. As with waste hydrochloric acid solutions without copper complexer, iron concentrations are very high, generally ranging from 2,000 to 6,000 mg/l, while other constituents consist of lower quantities of other boiler metals. Volume of waste associated with this cleaning process is generally four to five boiler volumes due to rinses and neutralization steps.

Hydroxyacetic/Formic Acid. Hydroxyacetic/formic acid has chelating properties which, at times, may enable a 3 percent solution of these mixed acids to exceed a dissolved iron content of 1.3 percent. Other metals generally do not have high concentrations in this waste cleaning solution due to absence in boiler metals. As with most organic solvents, the total volume will be twice the boiler capacity because a rinse must follow the cleaning step. The organic nature of the solvent will also result in elevated BOD levels.

Sulfuric Acid. This boiler cleaning agent is not widely used. The waste characteristics are probably similar to those of hydrochloric acid without copper complexer. Sulfuric acid is a strong acid which may find use in austenitic steels due to its low chloride content. Metal constituents will vary with their use in boiler metals. Volume of the waste, including rinses and neutralizing steps, will approach four to five boiler volumes.

### Sampling Results

A boiler cleaning effluent was analyzed for the presence of priority organics. None of the organics met or exceeded the limit of quantification.

## Boiler Fireside Washing

Boiler firesides are commonly washed by spraying high-pressure water against boiler tubes while they are still hot. Waste effluents from this washing operation contain an assortment of dissolved and suspended solids. Acid wastes are common for boilers fired with high-sulfur fuels. Sulfur oxides adsorb onto fireside deposits, causing low pH and a high sulfate content in the waste effluent (25). Table V-68 presents average and maximum concentrations of pollutants in fireside washes from Plant 3306 (43). Table V-69 shows historical waste load data for boiler fireside wash waters. Table V-70 presents a statistical analysis of fireside wash flow rates reported by the industry. The daily average flow was computed by multiplying the frequency of cleaning per year times the volume per cleaning and dividing the product by 365.

## Air Preheater Washing

Air preheaters employed in power stations are either the tubular or regenerative types. Both are periodically washed to remove deposits which accumulate. The frequency of washing is typically once per month; however, frequency variations ranging from 4 to 180 washings per year are reported (1). Many air preheaters are sectionalized so that heat transfer areas may be isolated and washed without shutdown of the entire unit (25). Higher wash frequencies are expected for air preheaters employing this design feature.

Fossil fuels with significant sulfur content will produce sulfur oxides which adsorb on air preheater deposits. Water washing of these deposits produces an acidic effluent. Alkaline reagents are often added to wash water to neutralize acidity, prevent corrosion of metallic surfaces, and maintain an alkaline pH. Alkaline reagents might include soda ash ( $\text{Na}_2\text{CO}_3$ ), caustic soda ( $\text{NaOH}$ ), phosphates, and/or detergent. Preheater wash water contains suspended and dissolved solids which include sulfates, hardness, and heavy metals, including copper, iron, nickel, and chromium (1, 25). Waste characteristics data for these waste waters are presented in table V-71. In table V-72, the EPA raw waste load data for air preheater wash water is shown. Table V-73 presents a statistical analysis of air preheater wash flow rates reported by the industry in response to the 308 questionnaire.

## COAL PILE RUNOFF

In order to ensure a consistent supply of coal for steam generation, plants typically maintain an outdoor reserve. A 90-day supply is generally maintained to provide a sufficient safety factor. This correlates to approximately 600 to 1,800  $\text{m}^3$  (780 to 2,340 yards<sup>3</sup>) of stored coal per megawatt of required capacity (1,20). Four factors which may preclude maintaining a large coal reserve are (20):

1. Cost of land required for storage,

Table V-68

AVERAGE AND MAXIMUM CONCENTRATIONS AND LOADING  
IN RAW WASTEWATER FROM FIRESIDE WASHES AT PLANT 3306 (43)

<u>Constituent</u>	<u>Concentration</u> (mg/l)	<u>Loading</u> (kg/cleaning)
Total chromium	15 max., 1.5 ave.	6.8 ave. (15 lb)
Hexavalent chromium	<1.0 max., 0.02 ave.	0.09 ave. (0.2 lb)
Zinc	40 max., 4.0 ave.	18 ave. (40 lb)
Nickel	900 max., 70 ave.	317 ave. (700 lb)
Copper	250 max., 6.0 ave.	27 ave. (60 lb)
Aluminum	21 max., 2.0 ave.	9 ave. (20 lb)
Iron	14,000 max., 2,500 ave.	11,340 ave. (25,000 lb)
Manganese	40 max., 3.5 ave.	16 ave. (35 lb)
Sulfate	10,000 max., 1,000 ave.	4,540 ave. (10,000 lb)
TDS	50,000 max., 5,000 ave.	22,680 ave. (50,000 lb)
TSS	25,000 max., 250 ave.	1,135 ave. (2,500 lb)
Oil and Grease	Virtually Absent	

Table V-69

WASTE LOAD DATA FOR BOILER FIRESIDE WASH  
 (Discharge Monitoring Data - EPA Regional Offices)  
 (mg/l)

<u>Pollutant</u>	<u>Mean Value</u>	<u>Standard Deviation</u>	<u>Minimum Value</u>	<u>Maximum Value</u>
Suspended solids (7 entries)	15,387	19,905	1,914	49,680
Copper (7 entries)	47.82	46.56	2.02	127.00
Iron (7 entries)	9,630.86	14,699.10	966	40,938

Table V-70

## FIRESIDE WASH WATER FLOWRATES

(308 Questionnaire Data)

<u>Variable</u>		<u>Number of Plants</u>	<u>Mean Value</u>	<u>Standard Deviation</u>	<u>Minimum Value</u>	<u>Maximum Value</u>
<u>Fuel coal*</u>						
Flow	gpd/plant	42	2,658	4,500	2.7	20,295
	gpd/MW	42	2.9	4.6	0.03	19
<u>Fuel gas*</u>						
Flow	gpd/plant	40	512	662	0.3	2,739
	gpd/MW	40	3.4	7	0.006	38.6
<u>Fuel oil*</u>						
Flow	gpd/plant	81	3,426	6,058	13.7	35,616
	gpd/MW	81	7	11.8	0.1	70

---

\*Fuel designations are determined by the fuel which contributes the most Btu for power generation in the year 1975.

Table V-71

AIR PREHEATER WASH WATER (1)  
(Plant 3410)

	<u>Case #1</u>	<u>Case #2</u>	<u>Case #3</u>
COD (mg/l)	50	70	60
SS	34	83	29
TDS	733	606	746
Oil	.25	8.5	.25
pH	3.5	3.2	3.3
Cl	18.5	16.6	27
SO <sub>4</sub>	2,480	1,920	2,720
Cond.	2,700	2,700	3,250
Hard. (CaCO <sub>3</sub> )	1,600	1,400	1,460
Ca	37.8	29.4	34.4
Mg	333	257	330
Fe (soluble)	515	335	460
Ni	20.8	18	34.8
Cr	1.45	1.0	1.25
Na	360	375	368
Zn	1.06	1.19	1.45

Table V-72

WASTE LOAD DATA FOR AIR PREHEATER WASH  
(Discharge Monitoring Data - EPA Regional Offices)  
(mg/l)

<u>Pollutant</u>	<u>Mean Value</u>	<u>Standard Deviation</u>	<u>Minimum Value</u>	<u>Maximum Value</u>
Suspended Solids (78 entries)	1,268.52	1,663.14	40	10,211
Copper (77 entries)	148.03	815.37	0.1	6,000
Iron	1,953.28	2,023.79	0.05	8,250

Table V-73

## AIR PREHEATER WASHWATER FLOWRATES

(308 Questionnaire Data)

<u>Variable</u>		<u>Number of Plants</u>	<u>Mean Value</u>	<u>Standard Deviation</u>	<u>Minimum Value</u>	<u>Maximum Value</u>
<u>Fuel. Coal*</u>						
Flow.	gpd/plant	148	10,844.4	22,234.04	2.7	156,164.4
	gpd/MW	147	14.5	31.8	0.01	320.2
<u>Fuel. Gas*</u>						
Flow	gpd/plant	56	980.1	1,922.8	0.27	9,863
	gpd/MW	56	3.8	6.2	0.002	25.9
<u>Fuel. Oil*</u>						
Flow	gpd/plant	110	10,666.7	50,872.6	1.4	526,027.4
	gpd/MW	110	17.6	62.2	0.02	618.8

---

\*Fuel designations are determined by the fuel which contributes the most Btu for power generation in the year 1975.



2. Labor force and equipment required to maintain coal storage area,
- 3 Cost of larger inventory, and
4. Loss in heating value of coal due to oxidative degradation.

The quantity of runoff is dependent on the amount of rainfall. A correlation developed by TVA to predict the runoff in inches per acre for a given storm event when the total inches of rainfall are known is given in equation 10 (44).

$$\text{Runoff} = 0.855 * \text{Rainfall} + 0.0082 \quad (10)$$

The following generalizations may be made with regard to emergence of contaminants in coal pile drainage (44):

1. For a coal pile of a given size and configuration, the amount of contaminants generated and flushed depends upon the residence time of the water within the coal pile.
2. The time required to complete the flushing of contaminants from the coal pile depends upon the volume of water applied (hydraulic head) and the duration of the application.
3. Before flushing is complete, concentrations of contaminants are inversely proportional to the flow rate of drainage runoff.
4. Upon completion of flushing, there is no significant change in contaminant levels with changes in flow rate.

The contaminants and their respective amounts can be classified into specific types according to chemical characteristics. The first type relates to pH of the coal pile drainage. The pH tends to be of an acid nature, primarily as a result of the oxidation of iron sulfide in the presence of oxygen and water. The reaction is believed to occur in two steps (20, 44). The products of the first step are ferrous iron and sulfuric acid as shown in equation 11.

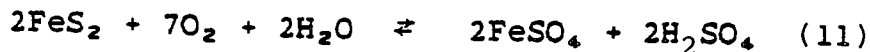

The ferrous iron ( $\text{Fe}^{2+}$ ) then undergoes oxidation to the ferric state ( $\text{Fe}^{3+}$ ) as shown in equation 12.

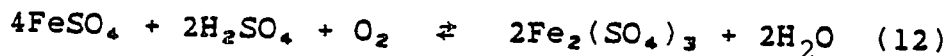

The reaction may proceed to form ferric hydroxide or basic ferric sulfate as shown in equations 13 and 14, respectively.

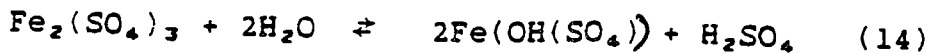
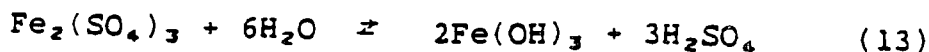

The ferric iron can also directly oxidize pyrite to produce more ferrous iron and sulfuric acid as shown in equation 15

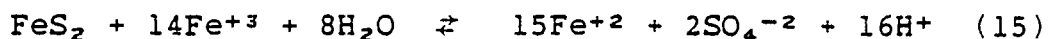

Thus, the oxidation of one mole of iron pyrite yields 2 moles of sulfuric acid.

As the pH of the pyritic systems decreases below 5, certain acidophilic, chemoautotrophic bacteria become active. These bacteria, Thiobacillus ferrooxidans, Ferrobacillus ferrooxidans, Metallogenium, and similar species are active at pH 2.0 to 4.5 and use  $\text{CO}_2$  as their carbon source (45). These bacteria are responsible for the oxidation of ferrous iron to ferric state, the rate limiting step in the oxidation of pyrite. Their presence is generally an indication of rapid pyrite oxidation and is accompanied by waters low in pH and high in iron, manganese, and total dissolved solids.

The potential influence of pH on the behavior of toxic and heavy metals is of particular concern. Many of the metals are amphoteric with regard to their solubility behavior. The factors affecting acidity, pH and the subsequent leaching of trace metals are (44):

1. Concentration and form of pyritic sulfur in coal;
2. Size of the coal pile;
3. Method of coal preparation and clearing prior to storage;
4. Climatic conditions, including rainfall and temperature;
5. Concentrations of  $\text{CaCO}_3$  and other neutralizing substances in the coal;
6. Concentration and form of trace metals in the coal; and
7. The residence time in the coal pile

Table V-74 contains results of analysis of samples from coal piles at two TVA plants. Both facilities exhibited very low pH values, however, the acidity values were quite variable in each of the cases, which demonstrates that acidity is not a measure of hydrogen ion but rather a measure of available protons. The suspended solids levels observed went up to 2,500 mg/l. Elevated levels of total suspended solids result when rainfall/runoff suspends coal fires in the pile. Most of the total dissolved solids concentrations are a consequence of enhanced pyritic oxidation via equations 11-15. Table V-75 displays data on the concentrations of metals in coal pile runoff from two TVA plants. An examination of the data reveals that there is a large degree of variability among the values. The metals present in the greatest concentrations were copper, iron, aluminum, and nickel. Others present in trace amounts include chromium, cadmium, mercury, arsenic, selenium, and beryllium.

Table V-74

## CHARACTERISTICS OF COAL PILE RUNOFF (44)

<u>Plant</u>		<u>pH</u>	<u>Acidity</u> <u>(mg/l</u> <u>CaCO )</u>	<u>Sulfate</u> <u>(mg/l)</u>	<u>Dissolved</u> <u>Solids</u> <u>(mg/l)</u>	<u>Suspended</u> <u>Solids</u> <u>(mg/l)</u>	<u>Fe</u> <u>(mg/l)</u>	<u>Mn</u> <u>(mg/l)</u>
J	Range	2.3-3.1	300-7100	1800-9600	2500-16000	8.0-2300	240-1800	8.9-45
	Mean	2.79	3400	5160	7900	470	940	28.7
	N	19	18	18	18	18	19	19
E	Range	2.5-3.1	860-2100	1900-4000	2900-5000	38-270	280-480	2.4-10.0
	Mean	2.67	1360	2780	3600	190	380	4.13
	N	6	6	6	6	6	6	6
E*	Range	2.5-2.7	300-1400	870-5500	1200-7500	69-2500	62-380	0.88-5.4
	Mean	2.63	710	2300	2700	650	150	2.3
	N	14	14	14	14	14	14	14

---

\*Discrete Storm

Table V-75

 CONCENTRATIONS OF METALS IN COAL PILE RUNOFF (44)  
 (mg/l)

<u>Plant</u>		<u>Cu</u>	<u>Zn</u>	<u>Cd</u>	<u>Al</u>	<u>Ni</u>
	Range	0.43-1.4	2.3-16	<.001-<.001	66.0-440	0.74-4.5
J	Mean	0.86	6.68	<.001	260	2.59
	N <sub>D</sub> *	0	0	19	0	0
	N <sup>+</sup>	19	19	19	19	19
	Range	0.01-0.46	1.1-3.7	<.001-0.003	22.0-60.0	
	0.24-0.46					
E	Mean	0.23	2.18	0.002	43.3	0.33
	N <sub>D</sub> *	0	0	2	0	0
	N <sup>+</sup>	6	6	6	6	6
		<u>Cr</u>	<u>Hg</u>	<u>As</u>	<u>Se</u>	<u>Be</u>
	Range	<0.005-.011	<.0002-.0025	.005-0.6	<.001-.03	0.03-0.07
J	Mean	.007	.0004	0.17	0.006	0.044
	N <sub>D</sub> *	11	12	0	4	0
	N <sup>+</sup>	17	20	19	18	18
	Range	<0.005-.011	0.003-.007	0.006-0.046	<.001-.001	<.01-0.03
E	Mean	0.007	0.004	0.02	0.001	0.014
	N <sub>D</sub> *	3	0	0	3	3
	N <sup>+</sup>	6	5	4	4	4

\*N<sub>D</sub> = Number of samples below detection limits.

## Wet Flue Gas Cleaning Processes

### Flue Gas Desulfurization Systems

In 1977 there were approximately 34 powerplants in the United States having operational FGD systems. In addition, 42 such systems were under construction (49). The breakdown of existing, constructed, and planned FGD systems by the type of process used for desulfurization of the stack gases is given in table V-76.

In all of the existing FGD systems the main task of absorbing  $\text{SO}_2$  from the stack gases is accomplished by scrubbing the exiting gases with an alkaline slurry. This may be preceded by partial removal of fly ash from the stack gases. Existing FGD processes may be divided into two categories: nonregenerable (throwaway) and regenerable. Nonregenerable flue gas desulfurization processes include lime, limestone, and lime/limestone combination and double alkali systems. The following is a short description of each process with characterization, where applicable or available, of the liquid wastes generated in the processes.

#### Nonregenerable Processes

Lime and Limestone Scrubbing Processes. In the lime or limestone flue gas desulfurization process  $\text{SO}_2$  is removed from the flue gas by wet scrubbing with a slurry of calcium oxide (lime) or calcium carbonate (limestone). The principal reactions for absorption of  $\text{SO}_2$  by slurry are:

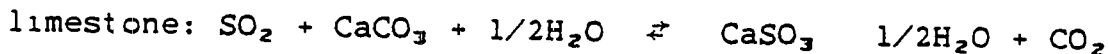
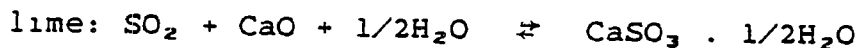

Oxygen absorbed from the flue gas or surrounding atmosphere causes the oxidation of absorbed  $\text{SO}_2$ . The calcium sulfite formed in the principal reaction and the calcium sulfate formed through oxidation are precipitated as crystals in a holding tank. The crystals are recovered in a solid/liquid separator. Waste solids disposal is accomplished by ponding or landfill. The clear liquid can be recycled.

A bleed stream is taken off the effluent hold tank to be dewatered. This step, necessary to minimize the land area needed for sludge disposal, varies depending on the application and type of disposal.

For systems with on-site pond disposal, solids may be pumped directly from the effluent hold tank to the pond area. Clean overflow liquor from the pond may then be returned to the system. If necessary, a thickening device such as a clarifier or centrifuge can be used to increase the solids content. Additional dewatering to 60-70 percent solids can sometimes be achieved by various systems including vacuum filtration.

Table V-76

## SUMMARY OF NEW AND RETROFIT FGD SYSTEMS BY PROCESS (49)

Process Type	New or Retrofit	Operational		Under Construction		Planned		Total No of Plants	
		No	MW	No	MW	No	MW	No	MW
Lime	N	4	2 450	10	4 565	0	0	16	8,440
	R	8	1 650	0	0	2	660	10	2,310
Lime/alkaline flyash	N	3	1 170	1	500	1	527	7	3,597
	R	0	0	0	0	3	579	3	579
Lime/limestone	N	0	0	0	0	0	0	0	0
	R	2	20	0	0	0	0	2	20
Limestone	N	8	4 443	23	9 620	5	2 880	45	21,726
	R	3	700	1	425	0	0	5	1,700
Subtotal-lime/limestone	N	15	8,963	34	14 685	6	3 407	68	33,763
	R	13	2 460	1	425	5	1 239	20	4 699
Aqueous	N	0	0	0	0	0	0	0	0
	R	0	0	0	0	0	0	1	100
Aqueous carbonate/sao filter	N	0	0	0	0	0	0	1	400
	R	0	0	0	0	0	0	0	0
Double alkali	N	0	0	2	825	0	0	2	825
	R	0	0	1	277	0	0	1	277
Magnesium oxide	N	0	0	0	0	0	0	0	0
	R	1	120	0	0	3	726	4	846
Not selected	N	0	0	0	0	18	9 500	19	9 800
	R	0	0	0	0	4	2,100	4	2,100
Regenerable not selected	N	0	0	0	0	0	0	0	0
	R	0	0	0	0	1	650	1	650
Sodium carbonate	N	1	125	1	509	1	125	3	759
	R	2	250	0	0	0	0	2	250
Wellman Lord	N	0	0	1	500	1	500	2	1,000
	R	0	0	1	180	0	0	1	180
Wellman Lord/Allied Chemical	N	1	375	0	0	0	0	1	375
	R	1	115	1	340	0	0	2	455
TOTALS	N	17	8,563	38	16,519	26	13,532	96	46 922
	R	17	2 945	4	1,222	13	4,715	36	9,557
Lime/limestone % of total MW	N	94		89		25		72	
	R	84		35		26		49	

NOTES N - new  
R - retrofit

Lime or limestone systems typically recycle overflow water from the thickener or settling pond. If all the overflow is recycled, the system is a closed loop system (no discharge). Many of the lime or limestone systems discharge scrubber waters usually to control dissolved solids levels.

Another source of discharge not common to all systems is the mist elimination wash. This involves the practice of either continuous or intermittent wash of the demister vanes of the scrubber. Scrubber slurry carryover (material carried from the contactor with the flue gas) is retained in the system by impacting the demister section. Cleaning of the demister is then accomplished by washing. The resulting wash water is then either sent to the thickener, recycle tank, or the settling pond. A summary of composition data for a typical demister wash is presented in table V-77.

Double Alkali Wet Scrubbing A number of processes can be considered double alkali processes. In the United States, most of the developmental work has emphasized sodium-based double alkali systems using lime for regeneration. Double alkali systems using an ammonia/calcium base have been tested, but they suffer the disadvantage of potentially producing a visible ammonium salt plume from the scrubbing system. The following process description will be limited to sodium/calcium-based processes.

Flue gas is pretreated in a venturi or tray type prescrubber to cool and humidify the gas and to reduce fly ash and chlorides. The humidification and cooling step prevents the evaporation of excessive amounts of water in the absorber. The potential for scaling and plugging problems is reduced by the removal of fly ash which, containing vanadium and iron compounds, can catalyze the oxidation of  $\text{Na}_2\text{O}_3$  to  $\text{Na}_2\text{SO}_4$ .

Cool and humidified gas from the prescrubber passes through an absorption tower, where  $\text{SO}_2$  is removed by absorption into a sodium hydroxide or sodium sulfite scrubbing solution. The scrubber effluent liquor is regenerated with lime or limestone in a reaction tank.

The calcium sulfite and calcium sulfate solids formed in the reaction tank were withdrawn from the system in a solid/liquid separator. After make-up alkali and water are added, the separator effluent liquor is recycled to the scrubbing loop. A liquid purge stream is required to remove soluble sodium sulfate. Failure to allow for sulfate removal from double alkali systems will ultimately result in (1) precipitation of sodium sulfate somewhere in the system if active sodium is made up to the system; or (2) in the absence of makeup, eventual deterioration of the  $\text{SO}_2$  removal capability due to the loss of active sodium from the system.

Discharges From Non-Regenerable Scrubbing Systems All the non-regenerable scrubbing systems have a disadvantage in that they produce large amounts of throwaway sludges which may pose problems in disposal. Onsite disposal is usually performed by sending the waste

Table V-77

COMPOSITION OF EFFLUENT FROM ONCE-THROUGH MIST ELIMINATOR  
WASH UNIT AT WET LIMESTONE SCRUBBER SYSTEM (50)

Water quality parameter	Concentration at indicated wash rate		
	40.7 l/min/m <sup>2</sup>	20.35 l/min/m <sup>2</sup>	10.18 l/min/m <sup>2</sup>
Acidity (methyl orange), as CaCO <sub>3</sub> , mg/l	49	-	120
Acidity (total), as CaCO <sub>3</sub> , mg/l	64	-	150
Ammonia nitrogen, mg/l	0.21	0.25	0.34
Calcium, mg/l	220	440	430
Chloride, mg/l	24	40	120
Conductance, umho/cm	1,300	1,600	2,700
Dissolved solids (total), mg/l	1,000	1,900	2,200
Hardness as CaCO <sub>3</sub> , mg/l	580	1,100	1,100
Magnesium, mg/l	6.5	8.2	18
pH, unit	3.1	-	2.7
Phosphate (total), mg/l	0.11	0.03	0.03
Potassium, mg/l	2.2	3	2.6
Sodium, mg/l	8.1	8.8	11
Sulfate, mg/l	700	1,000	1,200
Turbidity, JTU	<1	<1	2



Table V-77 (Continued)

COMPOSITION OF EFFLUENT FROM ONCE-THROUGH MIST ELIMINATOR  
WASH UNIT AT WET LIMESTONE SCRUBBER SYSTEM (50)

Water quality parameter	Concentration at indicated wash rate		
	40.7 l/min/m <sup>2</sup>	20.35 l/min/m <sup>2</sup>	10.18 l/min/m <sup>2</sup>
Aluminum, mg/l	<0.2	<0.2	<0.2
Arsenic, mg/l	0.002	0.002	0.01
Barium, mg/l	<0.1	<0.1	<0.1
Beryllium, mg/l	0.01	<0.01	<0.01
Cadmium, mg/l	0.0042	0.0013	0.0031
Chromium, mg/l	<0.05	<0.05	<0.05
Copper, mg/l	0.02	0.02	0.03
Cyanide, mg/l	<0.01	<0.01	<0.01
Iron, mg/l	5.8	0.07	5.5
Lead, mg/l	0.033	0.011	0.016
Manganese, mg/l	0.16	0.14	0.37
Mercury, mg/l	<0.0002	<0.0002	<0.0002
Nickel, mg/l	<0.05	<0.05	<0.05
Selenium, mg/l	0.012	0.024	-
Silver, mg/l	<0.01	<0.01	<0.01
Zinc, mg/l	0.07	0.02	0.14

solids to a large pond. After settling, the supernatant from the ponds may be recycled back into the scrubbing process. However, in 1977 only 6 of the total 34 plants (308 data) having operational FGD systems reported closed loop mode of operation. Actual practices at these facilities has not been confirmed at this time. Thus, the supernatant from the majority of plants was directed to the surface waters.

Table V-78 presents range of concentrations of chemicals in the scrubber liquors before settling. Liquor analyses were conducted on 13 samples from seven powerplants burning eastern or western coal and using lime, limestone or double alkali absorbents.

Wastewater Flows. Statistical analysis of wastewater flows from 28 powerplants indicating flue gas scrubber blowdown (308 data) is presented in table V-79. It should be noted that the corresponding question in the questionnaire reads "Flue Gas Scrubber Blowdown." Statistical analysis of wastewater flows categorized as "Scrubber Solids Pond Overflow" is presented in table V-80.

### Regenerable Processes

Wellman-Lord Sulfite Scrubbing Process The Wellman-Lord Sulfite Scrubbing Process is a regenerable flue gas desulfurization process marketed by Davy Powergas. It is based on the ability of a sodium sulfite solution to absorb  $\text{SO}_2$  and form a solution of sodium bisulfite. The sodium bisulfite solution can be thermally regenerated to produce a concentrated stream of  $\text{SO}_2$  and the original sodium sulfite solution. The concentrated  $\text{SO}_2$  stream can be processed to produce elemental sulfur, sulfuric acid, or recycled to the absorber. In the absorption phase of the process, sulfates formed by oxidation of sulfites are removed from the system in a purge of sodium sulfate and sulfite solids.

About 15 percent of the absorber product liquor is sent to purge treatment. The product resulting from the purge treatment is a crystalline mixture of anhydrous sodium sulfate (70 percent) and sodium sulfite (30 percent) with small amounts of thiosulfates, pyrosulfites and chlorides. The supernatant liquor is recycled (51). There is no planned wastewater or sludge streams associated with this process.

Magnesia Slurry Absorption Process. The Magnesia Slurry Absorption Process is a regenerable flue gas desulfurization process.  $\text{SO}_2$  is removed from the flue gases by wet scrubbing with a slurry of magnesium oxide. Magnesium sulfite is the predominant species formed in the absorption reaction below:

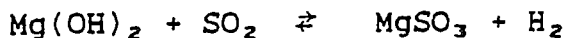

The absorber effluent is centrifuged. The liquor is sent to the slurry tank for combination with makeup water, makeup  $\text{MgO}$ , and regenerated  $\text{MgO}$  to form the slurry feed for the scrubber. The magnesium sulfite

Table V-78

RANGE OF CONCENTRATIONS OF CHEMICAL CONSTITUENTS IN FGD  
SLUDGES FROM LIME/LIMESTONE, AND DOUBLE-ALKALI SYSTEMS (52)

<u>Scrubber Constituent</u>	<u>Liquor, mg/l (except pH)</u>	<u>Solid, mg/kg</u>
Aluminum	0.03-2.0	
Arsenic	0.004-1.8	0.6-52
Beryllium	0.002-0.18	0.05-6
Cadmium	0.004-0.11	0.08-4
Calcium	180-2,600	105,000-268,000
Chromium	0.015-0.5	10-250
Copper	0.002-0.56	8-76
Lead	0.01-0.52	0.23-21
Magnesium	4.0-2,750	
Mercury	0.0004-0.07	0.01-5
Potassium	5.9-100	
Selenium	0.0006-2.7	2-17
Sodium	10.0-29,000	-48,000
Zinc	0.01-0.59	45-430
Chloride	420-33,000	
Fluoride	0.6-58	
Sulfate	600-35,000	35,000-473,000
Sulfite	0.9-3,500	1,600-302,000
Chemical oxygen demand	1-390	
Total dissolved solids	2,800-92,500	
pH	4.3-12.7	

Table V-79

FLUE GAS SCRUBBER BLOWDOWN  
(308 Questionnaire)

<u>Variable</u>		<u>Number of Plants</u>	<u>Mean Value</u>	<u>Standard Deviation</u>	<u>Minimum Value</u>	<u>Maximum Value</u>
<u>Fuel</u>	<u>Coal*</u>					
Flow.	GPD/plant	34	671,364.7	2,572,498.5	0.00	15,000,000
	GPD/MW	34	811.27	1,877,799	0.00	8,823.53

---

\*Fuel designations are determined by the fuel which contributes the most Btu for power generation for the year 1975.

Table V-80

FLUE GAS SCRUBBER SOLIDS POND OVERFLOW  
(308 Questionnaire)

<u>Variable</u>		<u>Number of Plants</u>	<u>Mean Value</u>	<u>Standard Deviation</u>	<u>Minimum Value</u>	<u>Maximum Value</u>
<u>Fuel</u>	<u>Coal*</u>					
Flow	GPD/plant	28	210,724.6	580,849.9	0.00	2,310,000
	GPD/MW	28	3,973.31	19,814.926	0.00	195,000

---

\*Fuel designations are determined by the fuel which contributes the most Btu for power generation for the year 1975.

cake is dried to remove free and bound water. Magnesium oxide is then regenerated in a calciner by thermal decomposition of the magnesium sulfite according to the equation below.



The concentrated  $\text{SO}_2$  gas stream can be used to promote sulfuric acid or elemental sulfur.

Summary. In general, data sufficient to characterize waste loadings resulting from flue gas cleaning processes are not available. No net discharge data, i.e., influent and effluent data, are currently available for those systems. Additional studies will be needed to provide this data and to confirm the current discharge practices in the industry.

## SECTION VI

### SELECTION OF POLLUTANT PARAMETERS

Section 502 of the Clean Water Act (1) defines a pollutant as follows:

The term "pollutant" means dredged spoil, solid waste, incinerator residue, sewage, garbage, sewage sludge, munitions, chemical wastes, biological materials, radioactive materials, heat, wrecked or discharged equipment, rock, sand, cellar dirt and industrial, municipal and agricultural waste discharged into water.

The selection of pollutant parameters for the 1974 Development Document (2) was based on a list of 71 pollutant parameters published by EPA (3) and supplemented with the following pollutant parameters:

- free available chlorine,
- polychlorinated biphenyls, and
- pH.

The pollutant parameters addressed in the 1974 Development Document were:

- pH,
- total solids,
- total suspended solids,
- total dissolved solids,
- biochemical oxygen demand (BOD),
- chemical oxygen demand (COD),
- chlorine residuals,
- alkalinity,
- acidity,
- total hardness,
- fecal coliform,
- surfactants,
- oil and grease,
- ammonia,
- total phosphorous,
- phenols,
- sulfate,
- sulfite,

- fluoride,
- chloride,
- bromide,
- iron,
- copper,
- mercury,
- vanadium,
- chromium,
- zinc,
- magnesium, and
- aluminum.

The primary focus for selection of pollutant parameters for BAT, NSPS, and pretreatment standards is the list of 126 priority pollutants. The assessment of the priority pollutants that may be discharged from steam electric powerplants was based on the analytical results from the sampling program, data from the 308 survey, and information published in the literature. Additionally, this program included a review of the wastestreams and pollutants regulated by the 1974 BAT, NSPS, PSNS and 1977 PSES regulations.

The toxic pollutants detected in the sampling program are listed in table VI-1 by waste stream source. Since the sampling program did not include all plants in this industry, pollutants which were not detected at the sampled facilities may be discharged from other facilities. For this reason, case-by-case determinations to regulate specific toxics may be necessary in those instances where a toxic pollutant is measured in detectable amounts in a particular discharge.

Pollutants at or below the level of quantification may be present at very low concentrations. The number of plants which reported (by questionnaire) various priority pollutants as known or suspected to be present in their waste streams are presented in table VI-2. In the 308 survey, powerplants were also requested to provide information regarding proprietary chemicals used during plant operations and their points of application. Table VI-3 provides a listing of those proprietary chemicals reported which contain one or more of the priority pollutants. The specific priority pollutants contained in each chemical was identified from the literature. The addition of any proprietary chemical containing a priority pollutant during operation of a plant would most likely result in the discharge of that pollutant in the plant's wastewater streams. Thus, knowledge of the chemical nature of proprietary chemicals and their point of application was an additional way of identifying priority pollutants in powerplant wastewater discharges.

The following discussion of pollutant parameter selection and exclusion is based upon raw and treated effluent data collected by EPA. These data are summarized for the reader in Section V of this document.



Table VI-1

PRIORITY POLLUTANTS DETECTED IN THE SAMPLING PROGRAM BY  
WASTE STREAM SOURCES

Priority Pollutant	Waste Stream Source						
	Once Through Cooling Water	Cooling Tower Blowdown	Combined Ash Sluice Water	Bottom Ash Sluice Water	Fly Ash Sluice Water	Low Volume Waste	Coal Pile Runoff *
Acenaphthene	0	0	0	0	0	0	0
Acrolein	0	0	0	0	0	0	0
Acrylonitrile	0	0	0	0	0	0	0
Benzene	X	X	X	0	0	X	0
Benzidene	0	0	0	0	0	0	0
Carbon Tetrachloride	0	0	0	0	0	0	0
Chlorobenzene	0	0	0	0	0	X	0
1,2,4-Trichlorobenzene	0	0	0	0	0	0	0
Hexachlorobenzene	0	0	0	0	0	0	0
1,2-Dichloroethane	0	0	0	0	0	X	0
1,1,1-Trichloroethane	X	0	0	0	X	X	0
Hexachloroethane	0	0	0	0	0	0	0
1,1-Dichloroethane	0	0	0	0	0	0	0
1,1,2-Trichloroethane	0	0	0	0	0	X	0
1,1,2,2-Tetrachloroethane	0	0	0	0	0	0	0
Chloroethane	0	0	0	0	0	0	0
Bis(Chloromethyl) Ether	0	0	0	0	0	0	0
Bis(2-Chloroethyl) Ether	0	0	0	0	0	0	0
2-Chloroethyl Vinyl Ether (Mixed)	0	0	0	0	0	0	0
2-Chloronaphthalene	X	0	0	0	0	0	0
2,4,6-Trichlorophenol	0	0	0	0	0	0	0
Parachlorometa Cresol	0	0	0	0	0	0	0
Chloroform	X	X	X	0	0	X	0
2-Chlorophenol	0	0	0	0	0	X	0
1,2-Dichlorobenzene	X	0	0	0	0	X	0
1,3-Dichlorobenzene	0	0	0	0	0	0	0

Table VI-1 (Continued)

PRIORITY POLLUTANTS DETECTED IN THE SAMPLING PROGRAM BY  
WASTE STREAM SOURCES

Priority Pollutant	Waste Stream Source						
	Once Through Cooling Water	Cooling Tower Blowdown	Combined Ash Sluice Water	Bottom Ash Sluice Water	Fly Ash Sluice Water	Low Volume Waste	Coal Pile Runoff *
1,4-Dichlorobenzene	0	0	X	0	0	X	0
3,3-Dichlorobenzidine	0	0	0	0	0	0	0
1,1-Dichloroethylene	X	X	X	0	0	0	0
1,2-Trans-Dichloroethylene	0	0	0	0	0	X	0
2,4-Dichlorophenol	X	X	0	0	0	X	0
1,2-Dichloropropane	0	0	0	0	0	0	0
1,3-Dichloropropene	0	0	0	0	0	0	0
2,4-Dimethylphenol	0	0	0	0	0	0	0
2,4-Dinitrotoluene	0	0	0	0	0	0	0
2,6-Dinitrotoluene	0	0	0	0	0	0	0
1,2-Diphenylhydrazine	0	0	0	0	0	0	0
Ethylbenzene	X	0	X	0	0	X	0
Fluoranthene	0	0	0	0	0	0	0
4-Chlorophenyl Phenyl Ether	0	0	0	0	0	0	0
4-Bromophenyl Phenyl Ether	0	0	0	0	0	0	0
Bis(2-Chloroisopropyl) Ether	0	0	0	0	0	0	0
Bis(2-Chloroethoxy) Methane	0	0	0	0	0	0	0
Methylene Chloride	X	0	X	0	X	X	0
Methyl Chloride	0	0	0	0	0	0	0
Methyl Bromide	0	0	0	0	0	0	0
Bromoform	X	0	0	0	0	X	0
Dichlorobromomethane	0	0	0	0	0	X	0
Trichlorofluoromethane	0	X	X	0	0	0	0
Dichlorodifluoromethane	0	0	0	0	0	0	0
Chlorodibromomethane	X	0	0	0	0	X	0
Hexachlorobutadiene	0	0	0	0	0	0	0

Table VI-1 (Continued)

PRIORITY POLLUTANTS DETECTED IN THE SAMPLING PROGRAM BY  
WASTE STREAM SOURCES

Priority Pollutant	Waste Stream Source						
	Once Through Cooling Water	Cooling Tower Blowdown	Combined Ash Sluice Water	Bottom Ash Sluice Water	Fly Ash Sluice Water	Low Volume Waste	Coal Pile Runoff *
Hexachlorocyclopentadiene	0	0	0	0	0	0	0
Isophorone	0	0	0	0	0	0	0
Naphthalene	0	0	0	0	0	0	0
Nitrobenzene	0	0	0	0	0	X	0
2-Nitrophenol	0	0	0	0	0	0	0
4-Nitrophenol	0	0	0	0	0	0	0
2,4-Dinitrophenol	0	0	0	0	0	0	0
4,6-Dinitro-O-Cresol	0	0	0	0	0	0	0
N-Nitrosodimethylamine	0	0	0	0	0	0	0
N-Nitrosodiphenylamine	0	0	0	0	0	0	0
N-Nitrosodi-N-Propylamine	0	0	0	0	0	0	0
Pentachlorophenol	X	0	0	0	0	0	0
Phenol	X	X	X	X	X	X	0
Bis(2-Ethylhexyl) Phthalate	X	X	X	0	X	0	0
Butyl Benzyl Phthalate	X	0	0	0	0	X	0
Di-N-Butyl Phthalate	X	0	0	0	X	0	0
Di-N-Octyl Phthalate	0	0	0	0	0	X	0
Diethyl Phthalate	X	0	0	0	0	0	0
Dimethyl Phthalate	0	0	X	0	0	0	0
Benzo(A)Anthracene	0	0	0	0	0	0	0
Benzo(A)Pyrene	0	0	0	0	0	0	0
Benzo(B)Fluoranthene	0	0	0	0	0	0	0
Benzo(K)Fluoranthene	0	0	0	0	0	0	0
Chrysene	0	0	0	0	0	0	0
Acenaphthylene	0	0	0	0	0	0	0
Anthracene	0	0	0	0	0	0	0
Benzo(G,H,I)Perylene	0	0	0	0	0	0	0

Table VI-1 (Continued)

PRIORITY POLLUTANTS DETECTED IN THE SAMPLING PROGRAM BY  
WASTE STREAM SOURCES

Priority Pollutant	Waste Stream Source						
	Once Through Cooling Water	Cooling Tower Blowdown	Combined Ash Sluice Water	Bottom Ash Sluice Water	Fly Ash Sluice Water	Low Volume Waste	Coal Pile Runoff *
Fluorene	0	0	0	0	0	0	0
Phenanthrene	0	0	0	0	0	0	0
Dibenzo(A,H)Anthracene	0	0	0	0	0	0	0
Indeno(1,2,3,-C,D)Pyrene	0	0	0	0	0	0	0
Pyrene	0	0	0	0	0	0	0
Tetrachloroethylene	X	X	X	0	0	X	0
Toluene	X	X	X	0	0	X	0
Trichloroethylene	X	0	0	0	0	X	0
Vinyl Chloride	0	0	0	0	0	0	0
Aldrin	0	0	0	0	0	0	0
Dieldrin	0	0	0	0	0	0	0
Chlordane	0	0	0	0	0	0	0
4,4-DDT	0	0	0	0	0	0	0
4,4-DDE	0	0	0	0	0	0	0
4,4-DDD	0	0	X	0	0	X	0
Endosulfan-Alpha	0	0	0	0	0	0	0
Endosulfan-Beta	0	0	0	0	0	0	0
Endosulfan Sulfate	0	0	0	0	0	0	0
Endrin	0	0	0	0	0	0	0
Endrin Aldehyde	0	0	0	0	0	0	0
Heptachlor	0	0	0	0	0	0	0
Heptachlor Epoxide	0	0	0	0	0	0	0
BHC-Alpha	0	0	0	0	0	0	0
BHC-Beta	0	0	0	0	0	0	0
BHC(Lindane)-Gama	0	0	0	0	0	0	0
BHC-Delta	0	0	0	0	0	0	0
PCB-1242 (Arochlor 1242)	0	0	0	0	0	0	0
PCB-1254 (Arochlor 1254)	0	0	0	0	0	0	0

Table VI-1 (Continued)

PRIORITY POLLUTANTS DETECTED IN THE SAMPLING PROGRAM BY  
WASTE STREAM SOURCES

<u>Priority Pollutant</u>	<u>Waste Stream Source</u>						
	<u>Once Through Cooling Water</u>	<u>Cooling Tower Blowdown</u>	<u>Combined Ash Sluice Water</u>	<u>Bottom Ash Sluice Water</u>	<u>Fly Ash Sluice Water</u>	<u>Low Volume Waste</u>	<u>Coal Pile Runoff *</u>
PCB-1221 (Arochlor 1221)	0	0	0	0	0	0	0
PCB-1232 (Arochlor 1232)	0	0	0	0	0	0	0
PCB-1248 (Arochlor 1248)	0	0	0	0	0	0	0
PCB-1260 (Arochlor 1260)	0	0	0	0	0	0	0
PCB-1016 (Arochlor 1016)	0	0	0	0	0	0	0
Toxaphene	0	0	0	0	0	0	0
Antimony (Total)	X	X	X	X	X	X	0
Arsenic (Total)	X	X	X	X	X	X	0
Asbestos(Total-Fibers/Liter)	0	X	0	0	0	0	0
Beryllium (Total)	0	X	X	X	X	0	X
Cadmium (Total)	X	X	X	X	X	X	X
Chromium (Total)	X	X	X	X	X	X	X
Copper (Total)	X	X	X	X	X	X	X
Cyanide (Total)	0	X	X	0	0	X	0
Lead (Total)	X	X	X	X	X	X	X
Mercury (Total)	X	X	X	X	X	X	0
Nickel (Total)	X	X	X	X	X	X	X
Selenium (Total)	X	X	X	X	X	X	0
Silver (Total)	X	X	X	0	0	X	0
Thallium (Total)	X	X	X	0	X	X	0
Zinc (Total)	X	X	X	X	X	X	X
2,3,7,8-Tetrachlorodibenzo- P-Dioxin	0	0	0	0	0	0	0

## Note:

- X = Present in greater concentration in the effluent than in the influent at least once.  
 0 = Never present in greater concentration in the effluent than in the influent.  
 \* = Since coal pile runoff has no influent stream (except rainfall), this column reflects whether or not the pollutant was ever detected in the coal pile effluent stream.

Table VI-2

NUMBER OF PLANTS REPORTING VARIOUS PRIORITY POLLUTANTS  
AS KNOWN OR SUSPECTED TO BE PRESENT IN VARIOUS WASTE STREAMS

(308 questionnaire data)

<u>Priority Pollutant</u>	Number of Plants Reporting by Waste Stream*					
	1	2	3	4	5	6
Acenaphten	9	0	0	0	0	0
Acrolein	0	0	0	0	0	0
Acrylonitrile	0	1	0	0	0	0
Aldrin-dieldrin	0	0	0	0	0	0
Antimony and Compounds	108	0	3	0	0	15
Arsenic and Compounds	155	13	2	2	11	36
Asbestos	5	0	0	32	9	4
Benzene	0	0	0	2	0	19
Benzidine	0	0	0	0	0	0
Beryllium and Compounds	96	0	0	1	0	15
Cadmium and Compounds	124	1	3	0	8	25
Carbon Tetrachloride	0	0	0	0	0	9
Chlordane	0	0	0	1	0	0
Chlorinated Benzenes	1	0	0	1	0	0
Chlorinated Ethanes	1	0	0	20	0	2
Chlorinated Phenols	0	0	7	1	0	1
Chloroalkyl Ethers	0	0	0	0	0	0
Chloroform	0	0	1	0	0	19
Chromium and Compounds	145	4	40	3	43	45
Copper and Compounds	132	38	8	9	76	69
Cyanides	18	0	0	0	0	12
DDT and Metabolites	0	0	0	0	0	0
Dichlorobenzenes	0	0	0	0	0	0
Dichloroethylenes	0	0	0	0	0	0
Diphenylhydrazine	0	1	0	0	0	0
EDTA	2	7	6	6	0	39

Table VI-2 (Continued)

NUMBER OF PLANTS REPORTING VARIOUS PRIORITY POLLUTANTS  
AS KNOWN OR SUSPECTED TO BE PRESENT IN VARIOUS WASTE STREAMS

(308 questionnaire data)

<u>Priority Pollutant</u>	Number of Plants Reporting by Waste Stream*					
	1	2	3	4	5	6
Flouranthene	0	0	0	0	0	0
Haloethers	0	0	0	0	0	0
Halomethanes	0	0	0	0	0	0
Heptachlor and Metabolites	0	0	0	0	0	0
Isophorone	1	0	0	0	0	0
Lead and Compounds	132	9	3	12	8	37
Mercury and Compounds	137	11	2	13	0	43
Naphthalene	0	0	0	0	0	14
Nickel and Compounds	137	14	3	3	65	48
Nitrosamines	6	0	0	0	0	0
PCBS	4	0	0	2	0	0
Pentachlorophenol	1	0	9	0	0	1
Phenol	5	6	2	1	2	19
Phthalate Esters	0	0	0	0	0	1
Polynuclear Aromatic Hydrocarbons	1	0	0	0	0	0
Selenium and Compounds	120	0	2	0	1	20
Silver and Compounds	83	3	2	0	0	26
Tetrachloroethylene	0	0	0	1	0	0
Thallium and Compounds	34	0	2	0	0	2
Toluene	0	0	0	0	0	18
Trichloroethylene	0	0	0	5	0	0
Vanadium	94	0	2	0	0	6
Vinyl chloride	0	0	0	0	1	0
Zinc and Compounds	142	7	22	9	59	49

Table VI-2 (Continued)

NUMBER OF PLANTS REPORTING VARIOUS PRIORITY POLLUTANTS  
AS KNOWN OR SUSPECTED TO BE PRESENT IN VARIOUS WASTE STREAMS

(308 questionnaire data)

<u>Priority Polutant</u>	Number of Plants Reporting by Waste Stream*					
	<u>1</u>	<u>2</u>	<u>3</u>	<u>4</u>	<u>5</u>	<u>6</u>
2-chlorophenol	0	0	0	0	0	0
2,4 Dichlorophenol	0	0	0	0	0	0
2,4 Dimethylphenol	0	0	0	1	0	7

---

\*Waste Streams:

- 1 - ash transport water
- 2 - water treatment wastes
- 3 - cooling system wastes
- 4 - maintenance wastes
- 5 - construction wastes
- 6 - other wastes



Table VI-3

PRIORITY POLLUTANT CONTAINING PROPRIETARY CHEMICALS  
USED BY POWER PLANTS

(308 questionnaire data)

<u>Proprietary Chemical (point of application*)</u>	<u>Specific Priority Pollutant Contained in Product (4,5)</u>
<u>NALCO CHEMICALS</u>	
25L (CT)*	COPPER
37 (BW)	CHROMIUM
38 (CW)	CHROMIUM
75 (BW)	PHENOL
201 (CT)	CHLORINATED PHENOLS
344 (CT)	ACRYLONITRILE
375 (CW)	CHROMIUM
425L(BW)	COPPER
<u>CALGON CHEMICALS</u>	
CL-70 (CT)	ZINC CHLORIDE
CL-35 (BW)	SODIUM DICROMATE
CL-68 (CW)	SODIUM DICHROMATE, ZINC CHLORIDE
<u>DEARBORN CHEMICALS</u>	
712 (CW)	CHLORINATED PHENOLS
<u>BETZ CHEMICALS</u>	
BETZ 40P (CW)	CHROMATE AND ZINC SALTS
BETZ 403 (CW)	CHROMATE AND ZINC SALTS
DIANODIC 191 (CW)	CHROMATE AND ZINC SALTS
<u>DOW CHEMICALS</u>	
DOWICIDE GB (ALGACIDE)	CHLORINATED PHENOLS
<u>HERCULES CHEMICALS</u>	
CR 403 (CT)	ZINC DICHROMATE, CHROMIC ACID
<u>DUPONT</u>	
KARMEX (CW)	CHLORINATED PHENOLS

Table VI-3 (Continued)

PRIORITY POLLUTANT CONTAINING PROPRIETARY CHEMICALS  
USED BY POWER PLANTS

(308 questionnaire data)

<u>Proprietary Chemical (point of application*)</u>	<u>Specific Priority Pollutant Contained in Product (4,5)</u>
<u>DREW CHEMICALS</u>	
BIOSPERSE 201 (CW)	CHLORINATED ETHANES
<u>ASHLAND CHEMICALS</u>	
1,1,1-TRICHLOROETHANE (FA)	CHLORINATED ETHANES
<u>BURRIS CHEMICALS</u>	
SODIUM DICHROMATE (CT)	SODIUM DICHROMATE

---

\*Point of Application.

BW - BOILER WATER  
CT - COOLING TOWER  
CW - COOLING WATER  
FA - FUEL ADDITIVE

## ONCE THROUGH COOLING WATER

Chlorine. Chlorine may be present in cooling water as free available chlorine (FAC) or as combined residual chlorine (CRC). It may be measured as FAC, CRC, or total residual chlorine (TRC); the latter measures both CRC and FAC.

FAC is the most toxic pollutant of the three. However, CRC is also toxic to aquatic life.<sup>a,b,c</sup> Limits on FAC alone would ignore the toxic contribution of CRC. Therefore, EPA concluded that regulation of TRC would better protect aquatic life from the toxic effects of both FAC and CRC. For this same reason EPA based the EPA water quality criteria for chlorine on TRC rather than FAC or CRC.<sup>a</sup>

Toxics. The discharge of polychlorinated biphenyl compounds (PCBs) is prohibited. This includes, but is not limited to, the seven PCBs on the list of 126 toxic pollutants. PCBs have been prohibited from discharge in this industry since 1974.

The following 95 toxic pollutants are excluded from national regulation for direct and indirect dischargers because they were not detected by Section 304(h) analytical methods or other state-of-the-art methods:

Acenaphthene  
Acrolein  
Acrylonitrile  
Benzidene  
Carbon Tetrachloride  
1,2,4-Trichlorobenzene  
Hexachlorobenzene  
Hexachloroethane  
1,1-Dichloroethane  
1,1,2,2-Tetrachloroethane  
Chloroethane  
Bis(2-Chloroethyl) Ether  
2-Chloroethyl Vinyl Ether (Mixed)  
2,4,6-Trichlorophenol  
Parachlorometa Cresol  
1,3-Dichlorobenzene  
3,3-Dichlorobenzidine  
1,2-Dichloropropane  
1,3-Dichloropropene  
2,4-Dimethylphenol  
2,4-Dinitrotoluene  
2,6-Dinitrotoluene  
1,2-Diphenylhydrazine  
Fluoranthene

---

<sup>a</sup> Quality Criteria for Water, EPA, July 1976.

<sup>b</sup> Chlorine Toxicity in Aquatic Ecosystems, Turner and Thayer, 1980.

<sup>c</sup> Chlorine Toxicity as a Function of Environmental Variables and Species Tolerance, Edison Electric Institute, November, 1981.

4-Chlorophenyl Phenyl Ether  
4-Bromophenyl Phenyl Ether  
Bis(2-Chloroisopropyl) Ether  
Bis(2-Chloroethoxy) Methane  
Methyl Chloride  
Methyl Bromide  
Hexachlorobutadiene  
Hexachlorocyclopentadiene  
Isophorone  
Naphthalene  
2-Nitrophenol  
4-Nitrophenol  
2,4-Dinitrophenol  
4,6-Dinitro-O-Cresol  
N-Nitrosodimethylamine  
N-Nitrosodiphenylamine  
N-Nitrosodi-N-Propylamine  
Benzo(A)Anthracene  
Benzo(A)Pyrene  
Benzo(B)Fluoranthene  
Benzo(K)Fluoranthene  
Chrysene  
Acenaphthylene  
Anthracene  
Benzo(G,H,I)Perylene  
Fluorene  
Phenanthrene  
Dibenzo(A,H)Anthracene  
Indeno(1,2,3,-C,D) Pyrene  
Pyrene  
Vinyl Chloride  
Aldrin  
Dieldrin  
Chlordane  
4,4-DDT  
4,4-DDE  
Endosulfan-Alpha  
Endosulfan-Beta  
Endosulfan Sulfate  
Endrin  
Endrin Aldehyde  
Heptachlor  
Heptachlor Epoxide  
BHC-Alpha  
BHC-Beta  
BHC(Lindane)-Gamma  
BHC-Delta  
Toxaphene

2,3,7,8-Tetrachlorodibenzo-P-Dioxin  
Chlorobenzene  
1,2-Dichloroethane  
1,1,2-Trichloroethane  
2-Chlorophenol  
1,3-Dichlorobenzene  
1,2-Trans-Dichloroethylene  
Dichlorobromomethane  
Nitrobenzene  
4,4-DDD  
Asbestos  
Beryllium  
Cyanide

The following seven toxic pollutants are excluded from regulation for direct and indirect dischargers because their detection in the final effluent samples is believed to be attributed to laboratory analysis and sampling contamination. Therefore, EPA believes these pollutants, although monitored in the effluents, are not detectable as a result of their presence in the effluent but rather as a result of contamination.

Methylene Chloride  
Bis(2-Ethylhexyl) Phthalate  
Butyl Benzyl Phthalate  
Di-N-Butyl Phthalate  
Di-N-Octyl Phthalate  
Diethyl Phthalate  
Dimethyl Phthalate

The following 24 toxic pollutants are excluded from national regulation because they are present in amounts too small to be effectively reduced by technologies known to the Administrator. The observed levels are generally less than 10 ug/l.

Benzene  
1,1,1-Trichloroethane  
2-Chloronaphthalene  
1,2-Dichlorobenzene  
1,1-Dichloroethylene  
2,4-Dichlorophenol  
Ethylbenzene  
Pentachlorophenol  
Phenol  
Tetrachloroethylene  
Toluene  
Trichloroethylene  
Antimony  
Arsenic

Cadmium  
Chromium  
Copper  
Lead  
Mercury  
Nickel  
Selenium  
Silver  
Thallium  
Zinc

The following three toxic pollutants are excluded from national regulation because the pollutants are detectable in only a small number of sources and are uniquely related to those sources and because the pollutants are present in amounts too small to be effectively reduced by technologies known to the Administrator.

Chloroform  
Bromoform  
Chlorodibromomethane

COOLING TOWER BLOWDOWN (Recirculating Cooling Water Systems).

#### Direct Dischargers

Chlorine. The Agency considered regulating chlorine by limiting total residual chlorine (TRC) as discussed above for once through cooling water. However, the Agency reexamined the data pertaining to chlorine. The Agency found that the flow of this waste stream was less than one percent of once-through cooling water flow for the industry. Less than 0.5 percent of the TRC which would be removed by regulating both cooling tower blowdown and once-through cooling water is attributable to cooling tower blowdown. EPA therefore concluded that the appropriate emphasis on TRC control should be in the once-through cooling waste stream and that BAT and NSPS for recirculating cooling systems should equal the FAC limits in previously promulgated BAT and NSPS.

Toxics. Of the 126 toxic pollutants, 124 are prohibited in detectable amounts where they are contained in cooling tower maintenance chemicals. This is based upon the Agency's finding that commercial cooling tower maintenance chemicals may contain one or more of the toxic pollutants, as discussed in Section V and VII and presented in Table VI-3.

The other two toxic pollutants, chromium and zinc, are retained for regulation from the 1974 regulation.

### Indirect Dischargers

Toxics. The 126 toxic pollutants are regulated as for direct dischargers. Since equivalent pollutant removals are required for indirect and direct dischargers, EPA determined that a zero discharge pretreatment standard for the 124 toxic pollutants was the means of assuring that no such priority pollutants would pass through a POTW.

### Low Volume Wastewaters

#### Direct Dischargers

The discharge of PCBs is prohibited for BAT and NSPS. This includes, but is not limited to, the seven PCBs on the list of toxic pollutants. PCBs have been regulated since 1974 in this industry. For NSPS, oil and grease continues to be regulated.

#### Indirect Dischargers

The discharge of PCBs is prohibited, as for direct dischargers.

#### Toxic Pollutants Excluded

The following 78 toxic pollutants are excluded from national regulation because they are not detected by Section 304(h) analytical methods or other state-of-the-art methods:

Acenaphthene  
Acrolein  
Acrylonitrile  
Benzidene  
Carbon Tetrachloride  
1,2,4-Trichlorobenzene  
Hexachlorobenzene  
Hexachloroethane  
1,1-Dichloroethane  
1,1,2,2-Tetrachloroethane  
Chloroethane  
Bis(2-Chloroethyl) Ether  
2-Chloroethyl Vinyl Ether (Mixed)  
2,4,6-Trichlorophenol  
Parachlorometa Cresol  
1,3-Dichlorobenzene  
3,3-Dichlorobenzidine  
1,2-Dichloropropane  
1,3-Dichloropropene  
2,4-Dimethylphenol  
2,4-Dinitrotoluene  
2,6-Dinitrotoluene  
1,2-Diphenylhydrazine  
Fluoranthene  
4-Chlorophenyl Phenyl Ether

4-Bromophenyl Phenyl Ether  
Bis(2-Chloroisopropyl) Ether  
Bis(2-Chloroethoxy) Methane  
Methyl Chloride  
Methyl Bromide  
Hexachlorobutadiene  
Hexachlorocyclopentadiene  
Isophorone  
Naphthalene  
2-Nitrophenol  
4-Nitrophenol  
2,4-Dinitrophenol  
4,6-Dinitro-O-Cresol  
N-Nitrosodimethylamine  
N-Nitrosodiphenylamine  
N-Nitrosodi-N-Propylamine  
Benzo(A)Anthracene  
Benzo(A)Pyrene  
Benzo(B)Fluoranthene  
Benzo(K)Fluoranthene  
Chrysene  
Acenaphthylene  
Anthracene  
Benzo(G,H,I)Perylene  
Fluorene  
Phenanthrene  
Dibenzo(A,H)Anthracene  
Indeno(1,2,3,-C,D) Pyrene  
Pyrene  
Vinyl Chloride  
Aldrin  
Dieldrin  
Chlordane  
4,4-DDT  
4,4-DDE  
Endosulfan-Alpha  
Endosulfan-Beta  
Endosulfan Sulfate  
Endrin  
Endrin Aldehyde  
Heptachlor  
Heptachlor Epoxide  
BHC-Alpha  
BHC-Beta  
BHC(Lindane)-Gamma  
BHC-Delta  
Toxaphene  
2,3,7,8-Tetrachlorodibenzo-P-Dioxin  
2-Chloronaphthalene  
1,1-Dichloroethylene  
Pentachlorophenol  
Asbestos  
Beryllium



The following 34 toxic pollutants are excluded from national regulation because they are present in amounts too small to be effectively reduced by technologies known to the Administrator. The observed levels are generally less than 10 ug/l.

Benzene  
Chlorobenzene  
1,2-Dichloroethane  
1,1,1-Trichloroethane  
1,1,2-Trichloroethane  
Chloroform  
2-Chlorophenol  
1,2-Dichlorobenzene  
1,4-Dichlorobenzene  
1,2-Trans-Dichloroethylene  
2,4-Dichlorophenol  
Ethylbenzene  
Bromoform  
Dichlorobromomethane  
Chlordibromomethane  
Nitrobenzene  
Phenol  
Tetrachloroethylene  
Toluene  
Trichloroethylene  
4,4-DDD  
Antimony  
Arsenic  
Cadmium  
Chromium  
Copper  
Cyanide  
Lead  
Mercury  
Nickel  
Selenium  
Silver  
Thallium  
Zinc

The following seven toxic pollutants are excluded from regulation because their detection in the final effluent samples is believed to be attributed to laboratory analysis and sampling contamination. Therefore, EPA believes these pollutants, although monitored in the effluent are not detectable as a result of their presence in the effluent but rather as a result of contamination.

Methylene Chloride  
Bis(2-Ethylhexyl) Phthalate  
Butyl Benzyl Phthalate  
Di-N-Butyl Phthalate  
Di-N-Octyl Phthalate  
Diethyl Phthalate  
Dimethyl Phthalate

### Fly Ash Handling

#### Direct Dischargers

BAT. The discharge of PCBs is prohibited for BAT, as in the 1974 BAT regulation. No non-conventional pollutants were identified for national regulation.

NSPS. The discharge of all wastewater pollutants is prohibited.

PSES. The discharge of PCBs is prohibited, as in the 1977 PSES regulation.

PSNS. The discharge of all wastewater pollutants is prohibited.

### Bottom Ash Handling

#### Direct Dischargers

The discharge of PCBs is prohibited for BAT and NSPS. This includes, but is not limited to, the seven PCBs on the list of toxic pollutants. PCBs have been regulated in this industry since 1974. Also, for NSPS, regulation of total suspended solids and oil and grease is retained from the 1974 NSPS.

#### Indirect Dischargers

The discharge of PCBs is prohibited for PSES and PSNS as for direct dischargers.

### Chemical Metal Cleaning Wastes

#### Direct Dischargers

The discharge of PCBs is prohibited. This includes, but is not limited to, the seven PCBs on the list of toxic pollutants. This is an extension of the 1974 prohibition on the discharge of PCBs.

The toxic pollutant copper and the non-conventional pollutant iron are regulated. This is an extension of the 1974 regulation.

### Indirect Dischargers

The discharge of PCBs is prohibited for direct dischargers. Also, the toxic pollutant copper is regulated for PSES and PSNS. These are an extension of the 1977 PSES requirements.

### Direct and Indirect Dischargers

The following 105 toxic pollutants are excluded from national regulation because they were not detected by Section 304(h) analytical methods or other state-of-the-art methods:

Acenaphthene  
Acrolein  
Acrylonitrile  
Benzidene  
Carbon Tetrachloride  
1,2,4-Trichlorobenzene  
Hexachlorobenzene  
Hexachloroethane  
1,1-Dichloroethane  
1,1,2,2-Tetrachloroethane  
Chloroethane  
Bis(2-Chloroethyl) Ether  
2-Chloroethyl Vinyl Ether (Mixed)  
2,4,6-Trichlorophenol  
Parachlorometa Cresol  
1,3-Dichlorobenzene  
3,3-Dichlorobenzidine  
1,2-Dichloropropane  
1,3-Dichloropropene  
2,4-Dimethylphenol  
2,4-Dinitrotoluene  
2,6-Dinitrotoluene  
1,2-Diphenylhydrazine  
Fluoranthene  
4-Chlorophenyl Phenyl Ether  
4-Bromophenyl Phenyl Ether  
Bis(2-Chloroisopropyl) Ether  
Bis(2-Chloroethoxy) Methane  
Methyl Chloride  
Methyl Bromide  
Hexachlorobutadiene  
Hexachlorocyclopentadiene  
Isophorone  
Naphthalene  
2-Nitrophenol  
4-Nitrophenol  
2,4-Dinitrophenol  
4,6-Dinitro-O-Cresol  
N-Nitrosodimethylamine  
N-Nitrosodiphenylamine  
N-Nitrosodi-N-Propylamine  
Benzo(A)Anthracene  
Benzo(A)Pyrene

Benzo(B)Fluoranthene  
Benzo(K)Fluoranthene  
Chrysene  
Acenaphthylene  
Anthracene  
Benzo(G,H,I)Perylene  
Fluorene  
Phenanthrene  
Dibenzo(A,H)Anthracene  
Indeno(1,2,3,-C,D) Pyrene  
Pyrene  
Vinyl Chloride  
Aldrin  
Dieldrin  
Chlordane  
4,4-DDT  
4,4-DDE  
Endosulfan-Alpha  
Endosulfan-Beta  
Endosulfan Sulfate  
Endrin  
Endrin Aldehyde  
Heptachlor  
Heptachlor Epoxide  
BHC-Alpha  
BHC-Beta  
BHC(Lindane)-Gama  
BHC-Delta  
Toxaphene  
2,3,7,8-Tetrachlorodibenzo-P-Dioxin  
Benzene  
Chlorobenzene  
1,2-Dichloroethane  
1,1,1-Trichloroethane  
1,1,2-Trichloroethane  
2-Chloronaphthalene  
Chloroform  
2-Chlorophenol  
1,2-Dichlorobenzene  
1,4-Dichlorobenzene  
1-1-Dichloroethylene  
1,2-Trans-Dichloroethylene  
2,4-Dichlorophenol  
Ethylbenzene  
Bromoform  
Dichlorobromomethane  
Chlorodibromomethane  
Nitrobenzene  
Pentachlorophenol  
Phenol  
Tetrachloroethylene  
Toluene  
Trichloroethylene  
4,4-DDD

Antimony  
Arsenic  
Asbestos  
Cyanide  
Mercury  
Selenium  
Silver  
Thallium

The following six toxic pollutants are excluded from national regulation because sufficient protection is already provided by the Agency's guidelines and standards under the Act. The BAT, PSES, PSNS, and NSPS limitations for copper and iron will effectively control the discharge of these pollutants.

Beryllium  
Cadmium  
Chromium  
Lead  
Nickel  
Zinc

The following seven toxic pollutants are excluded from regulation because their detection in the final effluent samples is believed to be attributed to laboratory analysis and sampling contamination. Therefore, EPA believes these pollutants, although monitored in the effluent are not detectable as a result of their presence in the effluent but rather as a result of contamination.

Methylene Chloride  
Bis(2-Ethylhexyl) Phthalate  
Butyl Benzyl Phthalate  
Di-N-Butyl Phthalate  
Di-N-Octyl Phthalate  
Diethyl Phthalate  
Dimethyl Phthalate

#### COAL PILE RUNOFF

##### Direct Dischargers

The discharge of PCB's is prohibited. This includes, but is not limited to, the seven PCB's on the list of toxic pollutants. This is an extension of the 1974 prohibition on PCB's. For BAT, no non-conventional pollutants were selected for national regulation. For NSPS, total suspended solids is regulated, as in the 1974 regulations.

### Indirect Dischargers

The discharge of PCB's is prohibited as for direct dischargers.

### Direct and Indirect Dischargers

The following 105 toxic pollutants are excluded from national regulation because they were not detected by Section 304(h) analytical methods or other state-of-the-art methods:

Acenaphthene  
Acrolein  
Acrylonitrile  
Benzidene  
Carbon Tetrachloride  
1,2,4-Trichlorobenzene  
Hexachlorobenzene  
Hexachloroethane  
1,1-Dichloroethane  
1,1,2,2-Tetrachloroethane  
Chloroethane  
Bis(2-Chloroethyl) Ether  
2-Chloroethyl Vinyl Ether (Mixed)  
2,4,6-Trichlorophenol  
Parachlorometa Cresol  
1,3-Dichlorobenzene  
3,3-Dichlorobenzidine  
1,2-Dichloropropane  
1,3-Dichloropropene  
2,4-Dimethylphenol  
2,4-Dinitrotoluene  
2,6-Dinitrotoluene  
1,2-Diphenylhydrazine  
Fluoranthene  
4-Chlorophenyl Phenyl Ether  
4-Bromophenyl Phenyl Ether  
Bis(2-Chloroisopropyl) Ether  
Bis(2-Chloroethoxy) Methane  
Methyl Chloride  
Methyl Bromide  
Hexachlorobutadiene  
Hexachlorocyclopentadiene  
Isophorone  
Naphthalene  
2-Nitrophenol  
4-Nitrophenol  
2,4-Dinitrophenol  
4,6-Dinitro-O-Cresol  
N-Nitrosodimethylamine  
N-Nitrosodiphenylamine  
N-Nitrosodi-N-Propylamine  
Benzo(A)Anthracene  
Benzo(A)Pyrene

Benzo(B)Fluoranthene  
Benzo(K)Fluoranthene  
Chrysene  
Acenaphthylene  
Anthracene  
Benzo(G,H,I)Perylene  
Fluorene  
Phenanthrene  
Dibenzo(A,H)Anthracene  
Indeno(1,2,3,-C,D) Pyrene  
Pyrene  
Vinyl Chloride  
Aldrin  
Dieldrin  
Chlordane  
4,4-DDT  
4,4-DDE  
Endosulfan-Alpha  
Endosulfan-Beta  
Endosulfan Sulfate  
Endrin  
Endrin Aldehyde  
Heptachlor  
Heptachlor Epoxide  
BHC-Alpha  
BHC-Beta  
BHC(Lindane)-Gamma  
BHC-Delta  
Toxaphene  
2,3,7,8-Tetrachlorodibenzo-P-Dioxin  
Benzene  
Chlorobenzene  
1,2-Dichloroethane  
1,1,1-Trichloroethane  
1,1,2-Trichloroethane  
2-Chloronaphthalene  
Chloroform  
2-Chlorophenol  
1,2-Dichlorobenzene  
1,4-Dichlorobenzene  
1,1-Dichloroethylene  
1,2-Trans-Dichloroethylene  
2,4-Dichlorophenol  
Ethylbenzene  
Bromoform  
Dichlorobromomethane  
Chlorodibromomethane  
Nitrobenzene  
Pentachlorophenol  
Phenol  
Tetrachloroethylene  
Toluene  
Trichloroethylene

4,4-DDD  
Antimony  
Arsenic  
Asbestos  
Cyanide  
Mercury  
Selenium  
Silver  
Thallium

The following seven toxic pollutants are excluded from national regulation because sufficient protection is already provided by the Agency's guidelines and standards under the Act. The BPT and NSPS limitation for total suspended solids will effectively control the discharge of these pollutants.

Beryllium  
Cadmium  
Chromium  
Copper  
Lead  
Nickel  
Zinc

The following seven toxic pollutants are excluded from regulation because their detection in the final effluent samples is believed to be attributed to laboratory analysis and sampling contamination. Therefore, EPA believes these pollutants, although monitored in the effluent are not detectable as a result of their presence in the effluent but rather as a result of contamination.

Methylene Chloride  
Bis(2-Ethylhexyl) Phthalate  
Butyl Benzyl Phthalate  
Di-N-Butyl Phthalate  
Di-N-Octyl Phthalate  
Diethyl Phthalate  
Dimethyl Phthalate



SECTION VII  
TREATMENT AND CONTROL TECHNOLOGY

INTRODUCTION

This section addresses treatment and control technologies judged to be effective in reducing or eliminating pollutants from steam electric power wastewaters. Wastewaters from steam electric powerplants vary in both quality and quantity from one plant to another. Control of pollutants, however, can be achieved in a uniform manner. The treatment and control technologies described in this section are those technologies which are available or currently in use in the steam electric power industry to decrease the discharge of toxic pollutants to navigable waters. The discussion of technologies is organized by major waste streams and waste stream categories: cooling water, ash handling, low volume wastes, metal cleaning wastes, and coal pile runoff.

ONCE-THROUGH COOLING WATER

In-Plant Discharge Control

Introduction

This section addresses in-plant treatment and control technologies that were judged to be effective in reducing or eliminating the concentration of total residual chlorine (TRC) in once-through cooling water. Chemical substitutions and improved process controls are two technology areas which contain potentially attractive control techniques. Housekeeping practices were examined for methods of TRC reduction: however, no such methods were discovered. In addition, changes in the manufacturing process were also examined. Although using dry cooling towers or a complete cooling water recirculation system would be effective in reducing TRC, these control techniques were judged not to be feasible from a cost standpoint because of retrofit costs. The following subsections discuss chemical substitutions and improved process controls and their associated costs.

Chemical Substitutions

TRC in once-through cooling water results from the application of chlorine to influent cooling water as a biofouling control agent. The substitution of other oxidizing agents for the chlorine will reduce or eliminate TRC in the cooling water. Oxidizing chemicals which were investigated include:

- Bromine chloride,
- Chlorine dioxide,
- Ozone,
- Bromine,
- Iodine.

The chemicals selected from this list for further evaluation were: bromine chloride, chlorine dioxide, and ozone.

### Bromine Chloride

#### Description of Technology

A bromine chloride biofouling control facility is identical to a chlorine biofouling control facility (described in Section B.1.3) except for minor changes required by differences in the physical and chemical properties of bromine chloride and chlorine. Bromine chloride is denser than chlorine, so the handling equipment and scales for the containers are of higher capacity. Bromine chloride exists in equilibrium with bromine and chlorine in both the liquid and the gaseous phases in containers. The vapor pressure of chlorine is higher than the vapor pressures of bromine and bromine chloride; therefore, a chlorine-rich vapor exists in the gas phase in containers. As a result, bromine chloride is always withdrawn from containers as a liquid, and an evaporator is used to convert the liquid to gas. Bromine chloride condenses at a higher temperature than chlorine, so the evaporator is designed to operate at a higher temperature in a bromine chloride facility than in a chlorine facility to prevent condensation of bromine chloride. The design changes consist of using steam or direct electric resistance heating rather than hot water. Bromine chloride attacks both steel and polyvinyl chloride which are the materials normally used in chlorination facilities. As a result, nickel or Monel is substituted for steel, and Kynar is substituted for polyvinyl chloride, in all parts which are in contact with liquid or vapor bromine chloride (1, 2).

#### Previous Industrial Applications

Bromine chloride has been used on a trial basis at three plants with once-through cooling water systems (3, 4, 5), but is not currently being used for biofouling control at any steam electric powerplants (2).

#### Effectiveness

The substitution of bromine chloride for chlorine in biofouling control should eliminate all total residual chlorine in the cooling water. Although total residual chlorine will not be present, bromine residuals, which are also toxic, will probably be present. Because of the toxic bromine residuals, this technology is not a preferred biofouling control technology.

## Chlorine Dioxide

### Description of Technology

Chlorine dioxide is a gas under standard conditions. At concentrations exceeding 15 to 20 percent, gaseous chlorine dioxide is unstable and, therefore, not suitable for handling in bulk form. As a result, chlorine dioxide is generated on site. Two methods of generating chlorine dioxide for biofouling control, the chlorine gas method and the hypochlorite method, are commonly used.

Chlorine Gas Method. When chlorine gas is dissolved in water, hypochlorous acid and hydrochloric acid are formed:



This is the reaction that occurs in the injector of a chlorination system. The chlorine dioxide biofouling control facility takes the chlorinated water stream from the injector and passes it through a packed column in which it reacts with a sodium chlorite solution to form chlorine dioxide:

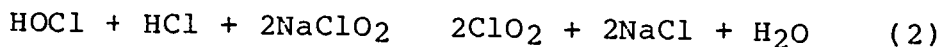

The resulting chlorine dioxide solution then enters the cooling water through a diffuser.

A simplified, schematic diagram of a chlorine dioxide biofouling control facility based on the chlorine gas generation method is presented in figure VII-1. The facility contains a complete chlorination system as described in the chlorine minimization section. In addition, the facility includes a sodium chlorite solution storage container, a metering pump for the sodium chlorite solution, and the packed column. The major component of the chlorine dioxide facility is the chlorination system.

The feed rate of chlorine dioxide to the cooling water is controlled by adjusting the feed rates of the chlorine gas and the sodium chlorite solution to the packed column. The feed rate of chlorine gas is controlled by the chlorinator in the chlorination system. The feed rate of the sodium chlorite solution is controlled by the metering pump. Since the flow of water through the packed column is provided by the booster pump in the chlorination system, the flow remains constant; therefore, changes in the feed rates of chlorine gas and sodium chlorite solution result in changes in the concentration of chlorine dioxide gas in the water entering the diffuser.

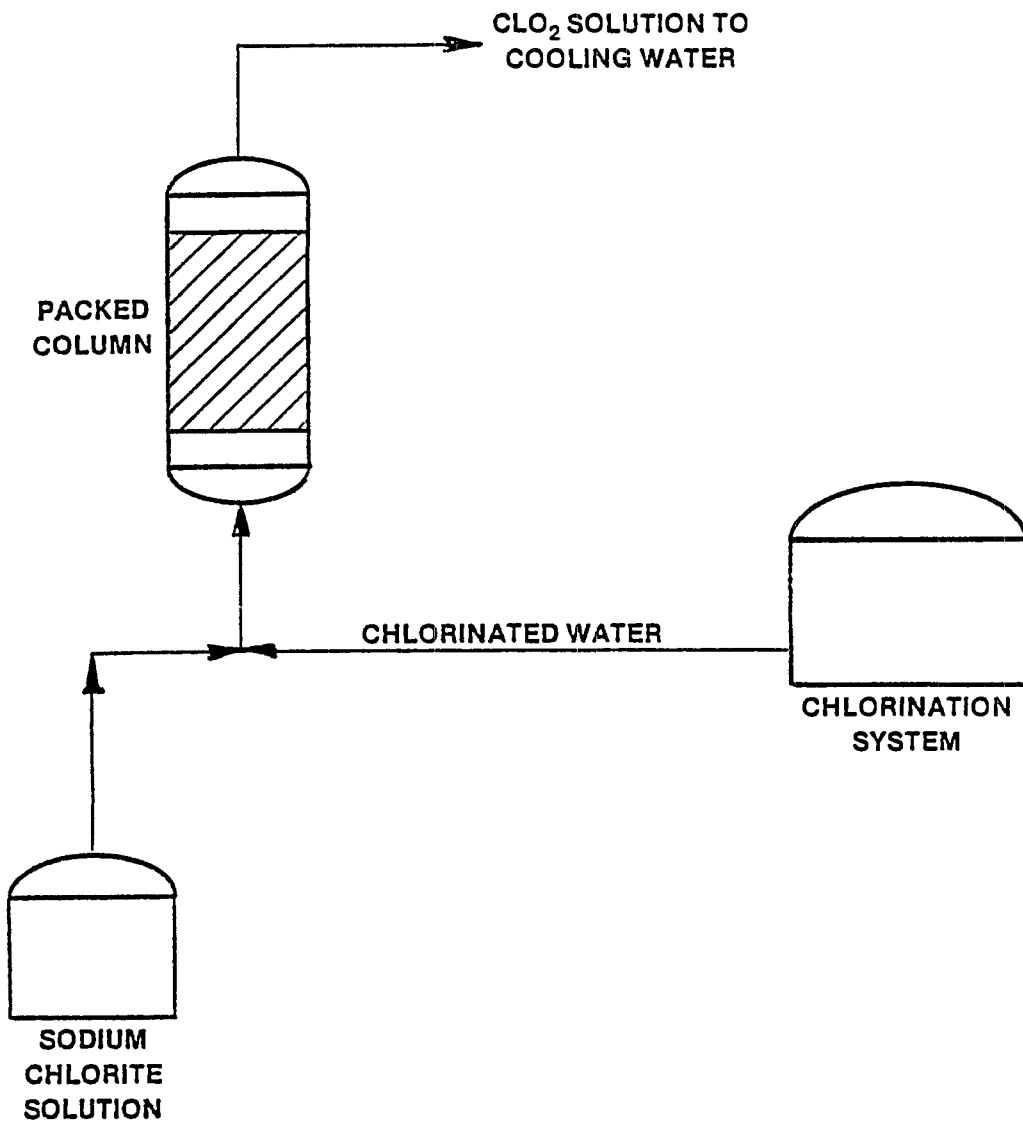

02 6162 1

Figure VII 1  
Simplified, Schematic Diagram of a Chlorine Dioxide Biofouling Control Facility  
Based on the Chlorine Gas Method ( 6 )

Hypochlorite Method. When sodium hypochlorite is dissolved in water, hypochlorous acid and sodium hydroxide are formed:

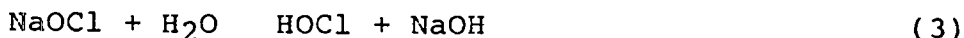

Reaction of the hypochlorous acid with a sodium chlorite solution produces chlorine dioxide:

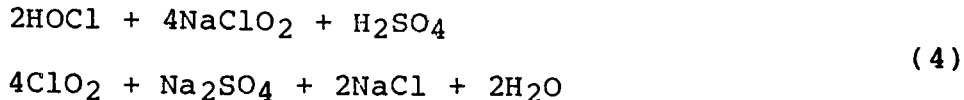

The sodium hydroxide formed in the reaction represented by equation 3 raises the pH of the solution above the optimum for the reaction in equation 4; therefore, sulfuric acid is added to the reaction represented by equation 4 to lower the pH. The reactions in equations 3 and 4 are the basis of the hypochlorite method.

A simplified, schematic diagram of a chlorine dioxide biofouling control facility based on the hypochlorite generation method is presented in figure VII-2. A side stream of cooling water is pumped to a packed column. Sulfuric acid and sodium hypochlorite are added by metering pumps to the water in the pipe between the pump and the column; thus, the reaction in equation 3 has occurred and the pH is at the optimum for the reaction in equation 4 when the water reaches the column. At this point, a sodium chlorite solution is added by a metering pump to the water, and the reaction in equation 4 occurs in the column. The resulting chlorine dioxide solution enters the cooling water through a diffuser. The feed rate of chlorine dioxide to the cooling water is controlled by adjusting the feed rate of the sodium hypochlorite and sodium chlorite solution metering pumps.

### Previous Industrial Applications

Chlorine dioxide is currently being used for biofouling control in a limited number of steam electric powerplants with once-through cooling water systems and in a single plant with a recirculating cooling water system (1).

### Effectiveness

The substitution of chlorine dioxide for chlorine in biofouling control should eliminate all total residual chlorine in the cooling water; however, the addition of excess chlorine in the generation of chlorine dioxide to insure maximum yield could create a total chlorine residual in the cooling water. The determination of the presence or absence of this residual and the concentration if the residual is present, is not possible. All of the methods of determining total residual chlorine are based on the oxidizing power of both free and combined chlorine residuals (7); chlorine dioxide residuals are also oxidizing agents.

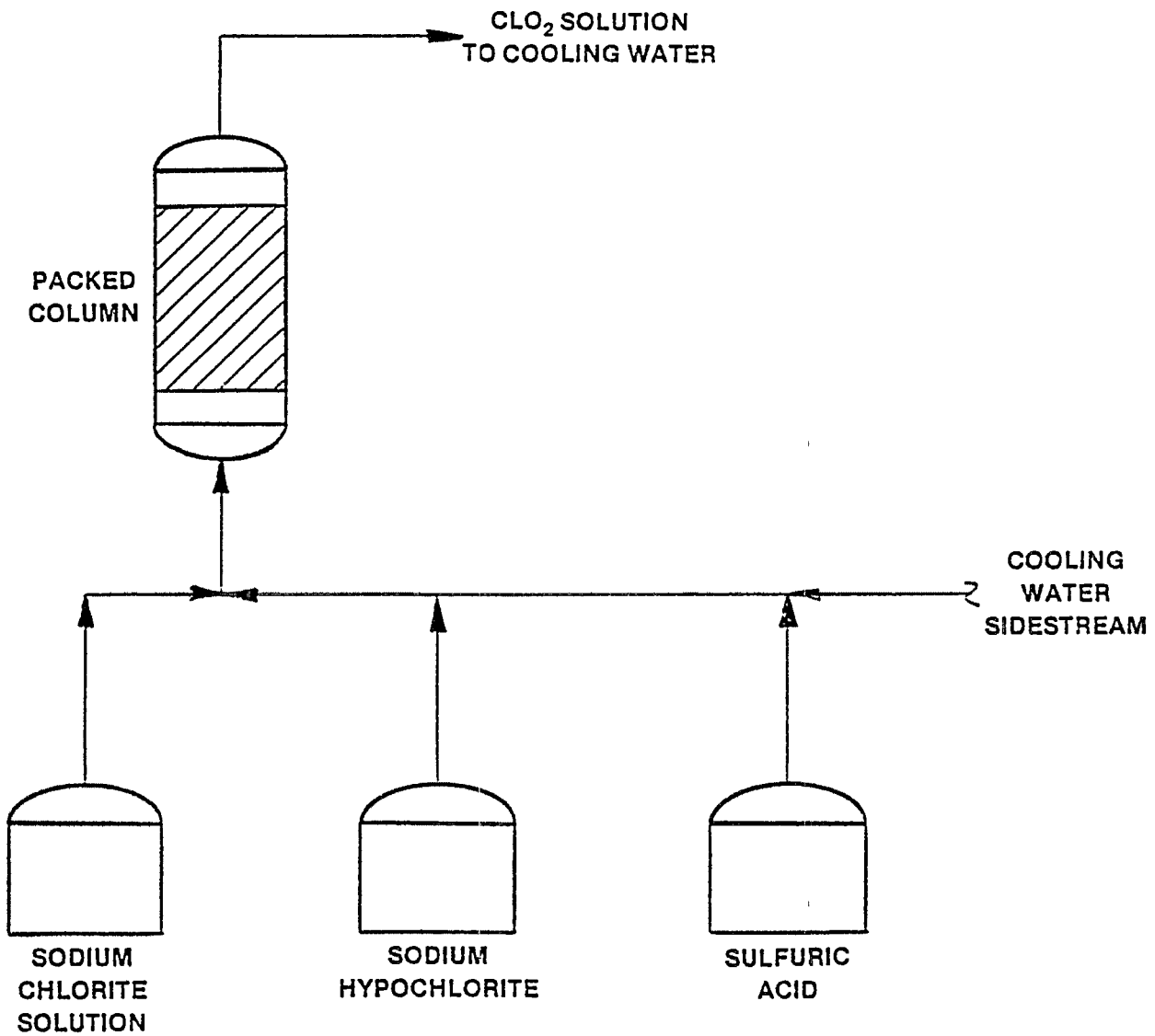

02 6164 1

Figure VII 2  
 Simplified, Schematic Diagram of a Chlorine Dioxide Biofouling Control Facility  
 Based on the Hypochlorite Method (6)

As a result, any attempt to measure total residual chlorine results in a measurement of both total residual chlorine and chlorine dioxide residuals. No officially accepted method of eliminating the chlorine dioxide residual interference is available (7).

In the absence of data on total residual chlorine in cooling water treated with chlorine dioxide, it was assumed that the concentration of total residual chlorine is zero. The basis for this assumption is fairly sound. The quantity of chlorine dioxide added to the cooling water is much greater than the quantity of chlorine added, and chlorine is a more powerful oxidant than chlorine dioxide (8). Therefore, the limited amount of chlorine is probably consumed by inorganic reducing agents and the biological fouling organisms before chlorine residuals are formed. Although total residual chlorine is probably not present, chlorine dioxide residuals, which are also toxic, are present. Therefore, this is not a preferred technology for reducing biofouling.

## Ozone

### Description of Technology

An ozone biofouling control facility consists of three systems: the ozone generating system, the gas treating system, and the gas-liquid contacting system.

Ozone is generated on site by passing an oxygen-bearing gas through a high frequency electric field called a corona. A schematic diagram of a corona cell is shown in figure VII-3. The cell consists of two electrodes separated by a narrow gap. One electrode is grounded and a high voltage alternating current is applied to the other electrode. This electrode discharges to the grounded electrode creating a high intensity corona discharge in the gap between the electrodes. The dielectric on the discharging electrode stabilizes the discharge over the entire electrode so that it does not localize in an intense arc. The corona discharge in the gap converts some of the oxygen in the oxygen-bearing gas passing through the gap to ozone. A relatively small amount of the energy in the discharge is utilized to convert oxygen to ozone; consequently, a substantial amount of heat is produced by the discharge. The low volume of gas passing through the gap cannot dissipate the heat, so the electrodes are cooled by either a liquid or a gas in contact with the side of the electrode opposite the discharge gap. The configuration of the corona cell, the materials of construction, and the cooling method vary with manufacturer (9, 10).

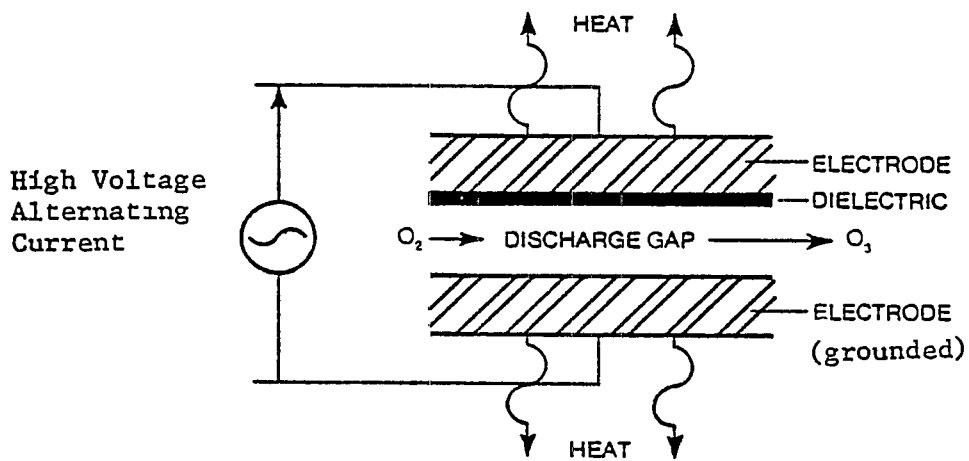

Figure VII-3  
 SCHEMATIC DIAGRAM OF CORONA CELL (9)



Ozone can be generated from either air or oxygen. In cooling water biofouling control applications, the choice between air and oxygen is based primarily on facility design capacity. For small capacity facilities, air is more economical. For large capacity facilities, oxygen is more economical. The breakpoint between air and oxygen is shown in figure VII-4 as a function of facility capacity expressed as flow and dosage.

Whether air or oxygen is used, the gas entering the generator must be dry. Moisture is removed from air by lowering its temperature, which causes the water to condense and then passing the air through a desiccant drier. Makeup oxygen comes directly from the oxygen source. Recycled oxygen is extracted from the waste gas from the gas-liquid contacting system. Moisture is removed from the recycled oxygen in the same way it is removed from air.

The three basic methods of supplying makeup oxygen for ozone generation are: on-site liquid oxygen storage, on-site generation by the pressure-swing adsorption process, and on-site generation by the cryogenic air separation process. On-site liquid oxygen storage requires an insulated tank, an evaporator, and the appropriate piping and valves. The stored liquid is withdrawn and vaporized to gas on demand. The supply of liquid oxygen is replenished periodically by tank truck deliveries from local suppliers. On-site storage is the preferred method when makeup requirements are less than 1 ton per day. On-site generation by the pressure-swing adsorption process is generally used for oxygen requirements of from 1 to 30 tons per day. In this process, air is compressed, cooled to condense moisture, and then passed through an adsorbent that removes carbon dioxide, water vapor, and nitrogen to produce a gas stream containing 90 to 95 percent oxygen. On-site generation by the cryogenic air separation process is generally used for oxygen requirements in excess of 30 tons per day, so this process is rarely used in ozonation systems (9).

The gas-liquid contacting system consists of a closed tank, diffusers, and an ozone decomposition device. Ozone is dispersed in water through diffusers which release the ozone as fine bubbles. The bubbles are dispersed in the water in a closed tank so that the ozone in the gases released from the water can be collected and passed through the ozone decomposition device before release of the gases to the atmosphere or recycle of the gases to the ozone generator. Ozone is fairly insoluble in water; therefore, contacting system designs must optimize the tradeoff between contact time and ozone utilization.

A typical ozonation facility using air to generate ozone is shown in figure VII-5. A typical ozonation facility using oxygen to generate ozone is shown in figure VII-6. The gas treating system, the ozone generating system, and the gas-liquid contacting system are delineated on the diagrams.

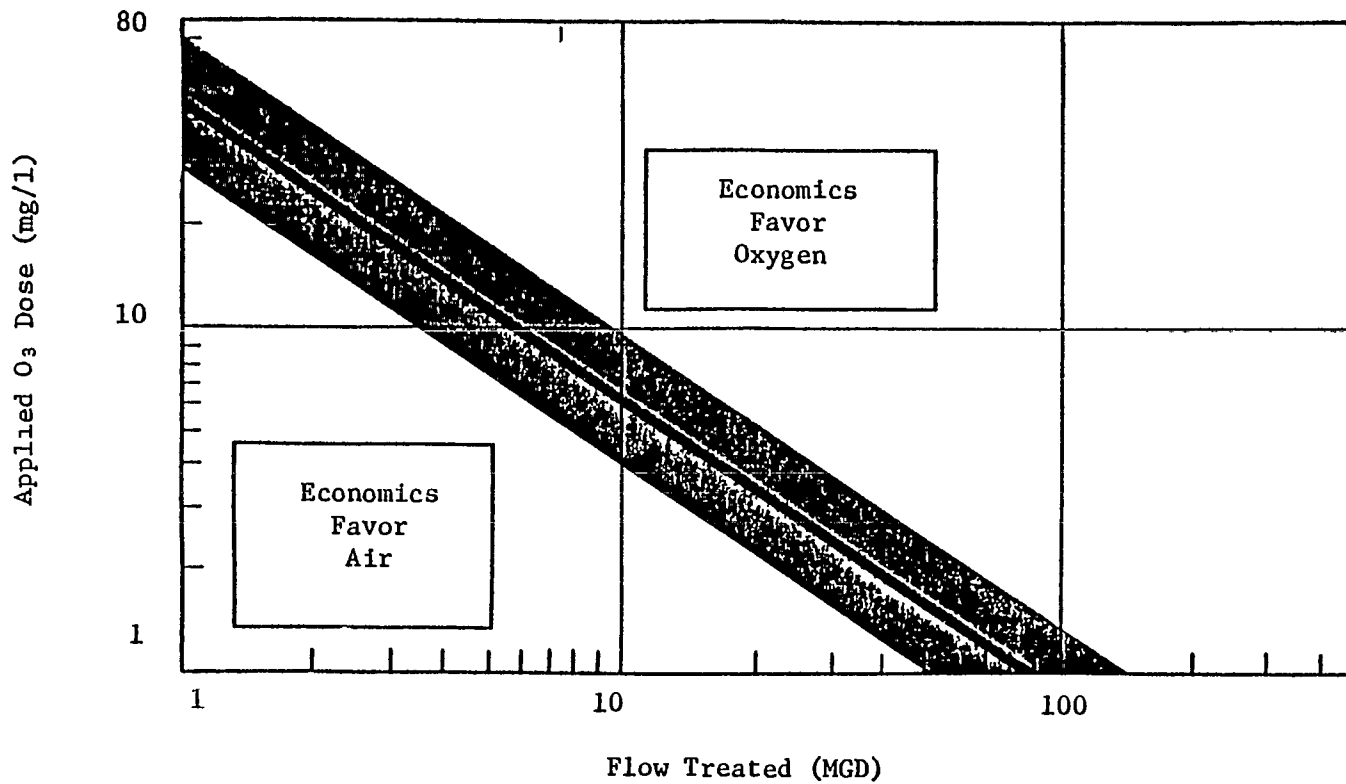

Figure VII-4  
EFFECT OF OZONATION FACILITY CAPACITY ON  
PROCESS CHOICE - OXYGEN VS AIR (28)

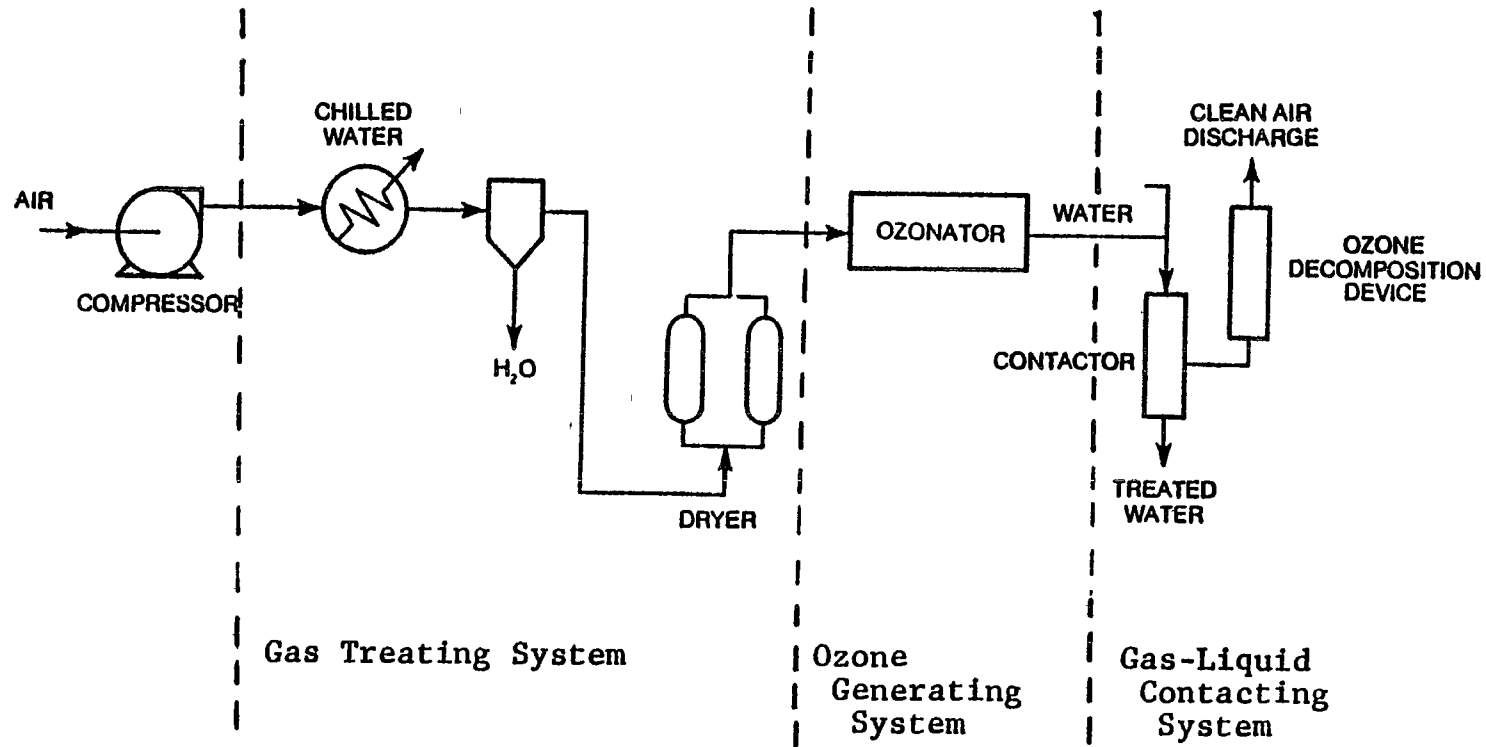

Figure VII 5  
OZONATION FACILITY USING AIR TO GENERATE OZONE (9)

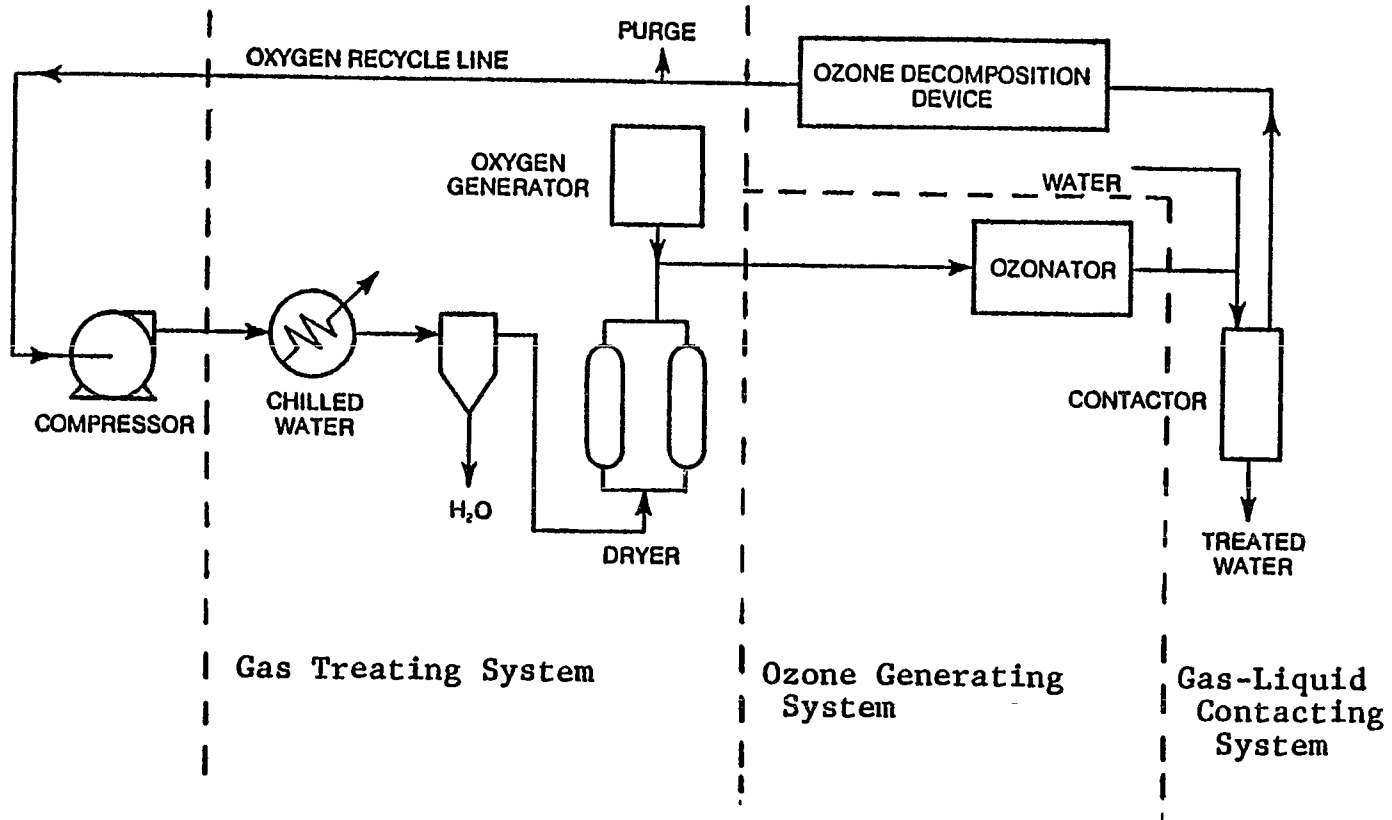

Figure VII-6  
OZONATION FACILITY USING OXYGEN TO GENERATE OZONE (9)

## Previous Industrial Applications

Ozone is not currently known to be used for biofouling control on a full-scale basis at any steam electric powerplant. Ozone has been used on a trial basis for biofouling control at one plant (1).

## Effectiveness

The substitution of ozone for chlorine in biofouling control should eliminate all total residual chlorine in the cooling water. Although total residual chlorine will not be present, other oxidant residuals, which are also toxic, will probably be present.

## Improved Process Control

Three process control improvements that are options for TRC control have been evaluated. These are: (1) chlorine minimization, (2) use of natural chlorine demand, and (3) mechanical cleaning. Each improved process control option is discussed below.

## Chlorine Minimization

Chlorine minimization is defined as any modification of a current cooling water chlorination program that reduces, to the minimum possible level, the loading of total residual chlorine (TRC) placed on a receiving water by the once-through cooling water system of a steam electric powerplant. Loading is the product of three factors: cooling water flowrate, TRC concentration in the cooling water discharge, and the length of time TRC is present in the discharge. Reduction of cooling water flow rate is not practical in a once-through system; therefore, chlorine minimization can be accomplished by reducing any of the following:

- o Dose of chlorine added; where dose is defined as the total weight of chlorine added per unit volume of cooling water, i.e., 1 mg/l, 2 mg/l, etc.;
- o Duration of chlorination period; where duration is defined as the length of time between the start and end of a single period of chlorine addition; and
- o Frequency of chlorination; where frequency is defined as the number of chlorination periods per day.

In addition, combinations of dose, duration and frequency may be reduced simultaneously to bring about a reduction in net loading of TRC to the environment.

Some plants add chlorine continuously in order to control bio-fouling from barnacles or fresh water clams. Often a low dose of chlorine is applied continuously for control of the hard shelled organisms--which can close their shell and endure intermittent chlorination periods--and a higher dose is applied intermittently at some duration and frequency for the control of biological slimes. Thus, plants which chlorinate continuously may be able to apply chlorine minimization by reducing their chlorine dose--for continuous chlorination--and reducing their dose, duration or frequency for intermittent chlorination.

### Description of Technology

A chlorine minimization program as described here has three components: upgrading the existing chlorination facility, conducting a minimization study, and implementing the recommendations of the study.

Upgrading Existing Chlorination Facility. An adequate chlorination facility must include an equipment module, an instrumentation module, and a structural module.

The equipment module contains the chlorine supply system. Two types of chlorine supply systems are used: chlorine gas systems and sodium hypochlorite generation systems. Sodium hypochlorite systems are considerably more expensive than gas feed systems and have seen limited application, primarily at plants which needed to avoid the necessity for regular deliveries of chlorine gas cylinders, or at plants where safety considerations suggested the use of a system not involving chlorine gas. Since the use of sodium hypochlorite generators is limited, the analysis does not consider these units further; nevertheless, the concepts of chlorine minimization developed for gas feed chlorination systems can be similarly applied to hypochlorite generation systems.

In gas feed chlorination systems, chlorine is manufactured off-site, compressed in steel containers, and shipped to the plant site as a liquid. Containers with a wide range of capacities are used. Cylinder capacity commonly ranges from 150 pounds to 1 ton of chlorine. Selection of container size is primarily a function of average daily chlorine consumption. Selection of the number of containers is primarily a function of facility design capacity and method of withdrawal (11). Generally, systems with a chlorine withdrawal requirement of more than 17 pounds per hour per 1 ton container use liquid withdrawal systems. Most steam electric powerplants fall into this category. Some small plants may use gas withdrawal systems.

Transmission of the chlorine from the containers to the metering system differs for gas withdrawal and liquid withdrawal. For gas withdrawal, the gas passes through a filter and, in some cases, a pressure-reducing valve. The filter removes impurities in the

in the chlorine solution line. If the vacuum falls below 25 inches of mercury, the metering system will not operate properly. The flow of water required to avoid these problems can be determined from manufacturer's injector efficiency curves. The pressure must be high enough to overcome the back pressure on the injector and the pressure loss through the injector. The back pressure on the injector is the sum of the static pressure at the point of injection and friction losses in the piping between the injector and the point of injection. The pressure loss through the injector can also be determined from manufacturer's injector efficiency curves. Given the required discharge volume and pressure, the proper booster pump can be selected (11).

The hypochlorous acid solution from the injector is dispersed in the cooling water with a diffuser. Two basic types of diffusers are available. For pipelines flowing full, the diffusers are essentially pipes mounted on the cooling water conduit perpendicular to the flow of cooling water and discharging at the center of the conduit. For open channel flow, the diffusers are perforated pipes mounted in the open channel. In steam electric powerplant applications, the open channel condition exists when the hypochlorous acid solution is added to the cooling water before it enters the circulating water pumps, and the full pipeline condition exists when the hypochlorous acid solution is added to the cooling water before it enters the condensers (11).

The instrumentation module consists of timers, a chlorine residual analyzer/recorder, a scale, and a chlorine leak detector. Timers are applicable to intermittent chlorination, not to continuous chlorination. The timers automatically start and stop the booster pump which in turn activates and deactivates the equipment module. The timers are set so that chlorination occurs with the frequency and duration desired. The chlorine residual analyzer/recorder continuously analyzes for total residual chlorine in the cooling water discharge and overrides the timers to stop the booster pump if the total residual chlorine concentration exceeds a predetermined level. The scale is used to weigh the chlorine containers in service in order to track consumption and to determine when containers need to be replaced. The chlorine leak detector monitors the air in the chlorination building for chlorine gas and sounds an alarm if any of the gas is detected (12).

The structural module consists of a building for the equipment and instrumentation modules. The building must be properly ventilated and heated. When one-ton chlorine containers are being used, a hoist must be provided with the building (11).

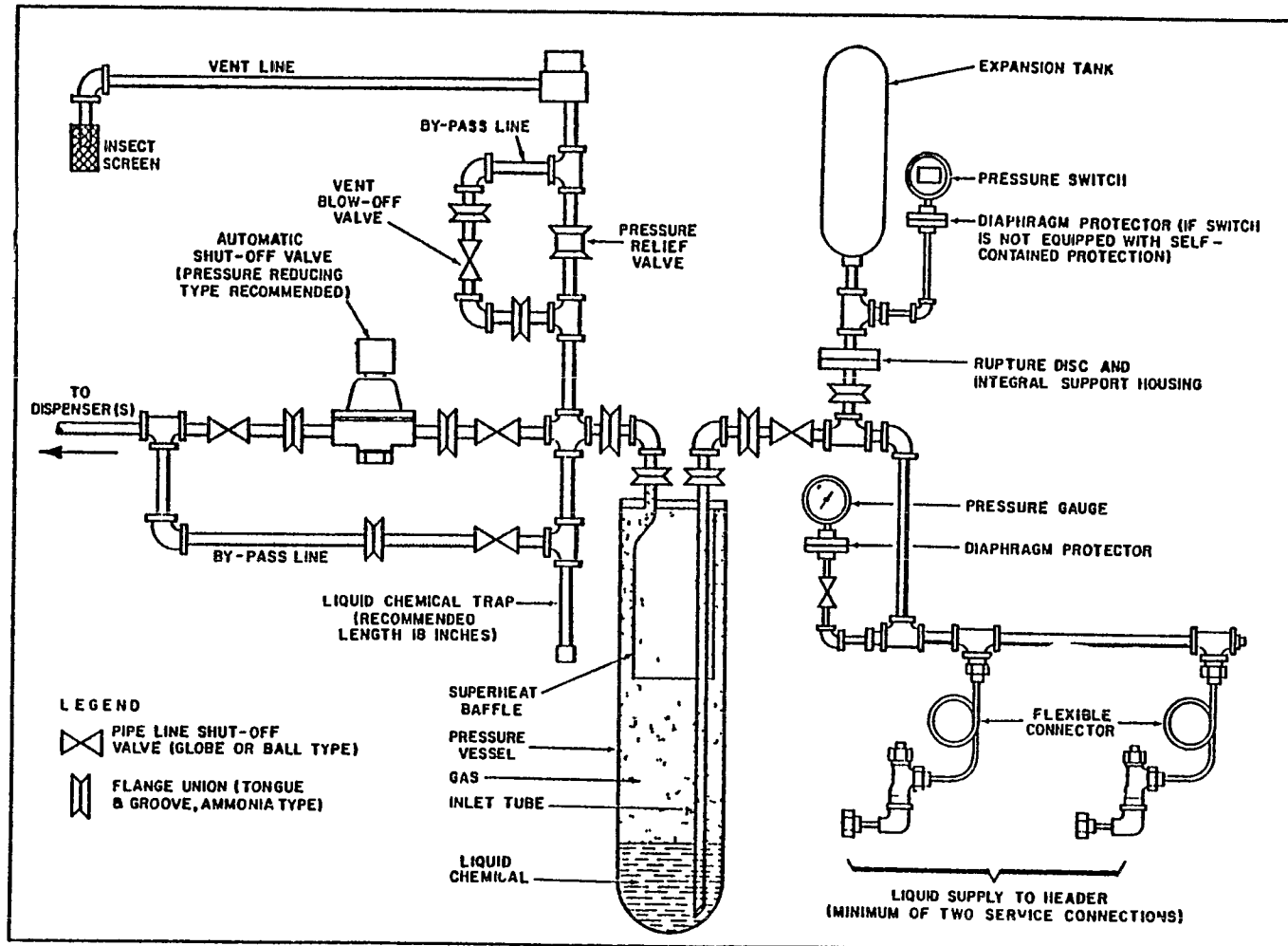

Figure VII 7

## LIQUID SUPPLY CHLORINATION SYSTEM

Reprinted from Instruction Bulletin 70-9001 by Fischer and Porter Co., April, 1977



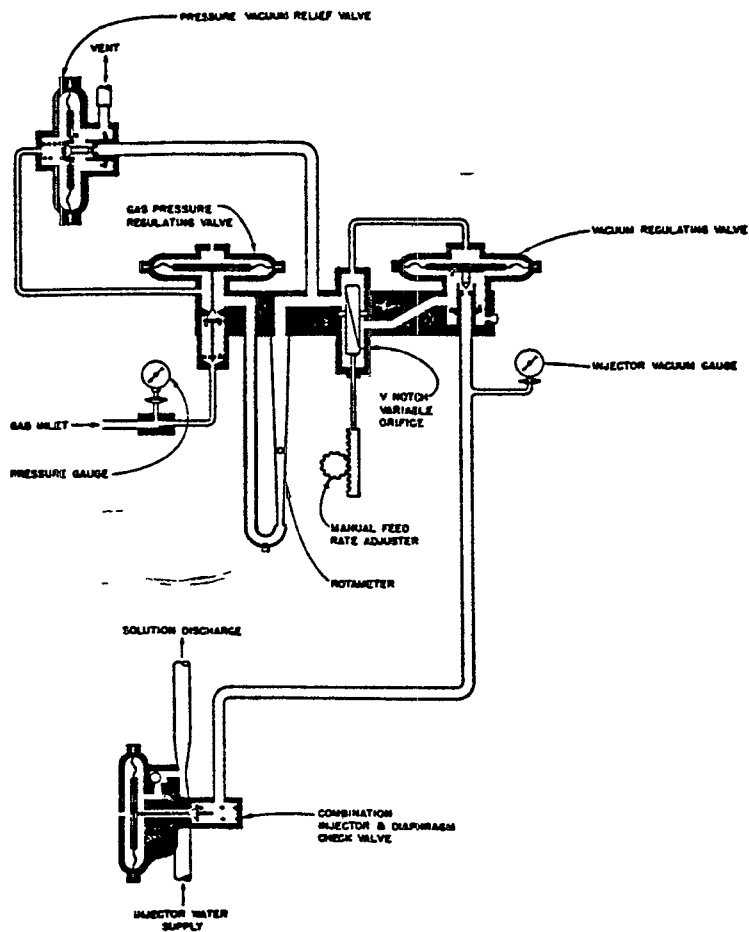

Figure VII-8  
 SCHEMATIC DIAGRAM OF A TYPICAL CHLORINATOR

Reprinted from Handbook of Chlorination by G. C. White by permission of Van Nostrand Reinhold Company. Year of first publication. 1972.

in the chlorine solution line. If the vacuum falls below 25 inches of mercury, the metering system will not operate properly. The flow of water required to avoid these problems can be determined from manufacturer's injector efficiency curves. The pressure must be high enough to overcome the back pressure on the injector and the pressure loss through the injector. The back pressure on the injector is the sum of the static pressure at the point of injection and friction losses in the piping between the injector and the point of injection. The pressure loss through the injector can also be determined from manufacturer's injector efficiency curves. Given the required discharge volume and pressure, the proper booster pump can be selected (11).

The hypochlorous acid solution from the injector is dispersed in the cooling water with a diffuser. Two basic types of diffusers are available. For pipelines flowing full, the diffusers are essentially pipes mounted on the cooling water conduit perpendicular to the flow of cooling water and discharging at the center of the conduit. For open channel flow, the diffusers are perforated pipes mounted in the open channel. In steam electric powerplant applications, the open channel condition exists when the hypochlorous acid solution is added to the cooling water before it enters the circulating water pumps, and the full pipeline condition exists when the hypochlorous acid solution is added to the cooling water before it enters the condensers (11).

The instrumentation module consists of timers, a chlorine residual analyzer/recorder, a scale, and a chlorine leak detector. Timers are applicable to intermittent chlorination, not to continuous chlorination. The timers automatically start and stop the booster pump which in turn activates and deactivates the equipment module. The timers are set so that chlorination occurs with the frequency and duration desired. The chlorine residual analyzer/recorder continuously analyzes for total residual chlorine in the cooling water discharge and overrides the timers to stop the booster pump if the total residual chlorine concentration exceeds a predetermined level. The scale is used to weigh the chlorine containers in service in order to track consumption and to determine when containers need to be replaced. The chlorine leak detector monitors the air in the chlorination building for chlorine gas and sounds an alarm if any of the gas is detected (12).

The structural module consists of a building for the equipment and instrumentation modules. The building must be properly ventilated and heated. When one-ton chlorine containers are being used, a hoist must be provided with the building (11).

Chlorine Minimization Study. A chlorine minimization study consists of three phases. The first phase establishes the following relationships:

- condenser performance and dose of chlorine added to the cooling water,
- condenser performance and duration of chlorination period, and
- condenser performance and frequency of chlorination.

Condenser fouling is commonly measured in terms of turbine back pressure.

The second phase consists of screening trials in which the chlorine residual in the cooling water discharge, the duration of the chlorination events, and the frequency of the chlorination events are each reduced below the baseline level until condenser performance drops below the baseline levels. The screening trials define the minimum chlorine dose, duration and frequency levels which can maintain adequate condenser performance. Throughout all of the screening trials, the TRC level and frequency and duration of chlorination for one unit are maintained at the baseline levels for the appropriate season of the year in order to detect any shifts in the baselines.

A set of screening trials is conducted for each chlorination parameter: dose, duration, and frequency of chlorination. The objective of each set of trials is to converge on the minimum value for the parameter under consideration. The other two parameters are held constant. The procedure for conducting a set of screening trials is shown in figure VII-9. The set of screening trials for TRC level are conducted first using the baseline levels for duration and frequency of chlorination for the appropriate seasons of the year. After the minimum TRC level has been determined, the set of screening trials for duration of chlorination are conducted using the seasonally adjusted minimum TRC level and the baseline level of chlorination frequency for the appropriate season of the year. At the completion of this set of trials, the set of screening trials for frequency of chlorination is conducted using the seasonally adjusted minimum TRC level and the seasonally adjusted minimum duration of chlorination. When all three sets of screening trials have been completed, the minimum values of TRC level, duration of chlorination, and frequency of chlorination are known.

The third phase is a long-term trial of the chlorine minimization program defined in the second phase. The minimum chlorine dose, duration, and frequency are maintained and condenser performance is monitored. If performance is satisfactory over the long term, the chlorine minimization program is instituted permanently (13, 14, 15).

Figure VII-9

PROCEDURE FOR CONDUCTING A SET OF SCREENING TRIALS TO CONVERGE ON THE MINIMUM VALUE FOR TRC LEVEL, DURATION OF CHLORINATION, AND CHLORINATION FREQUENCY

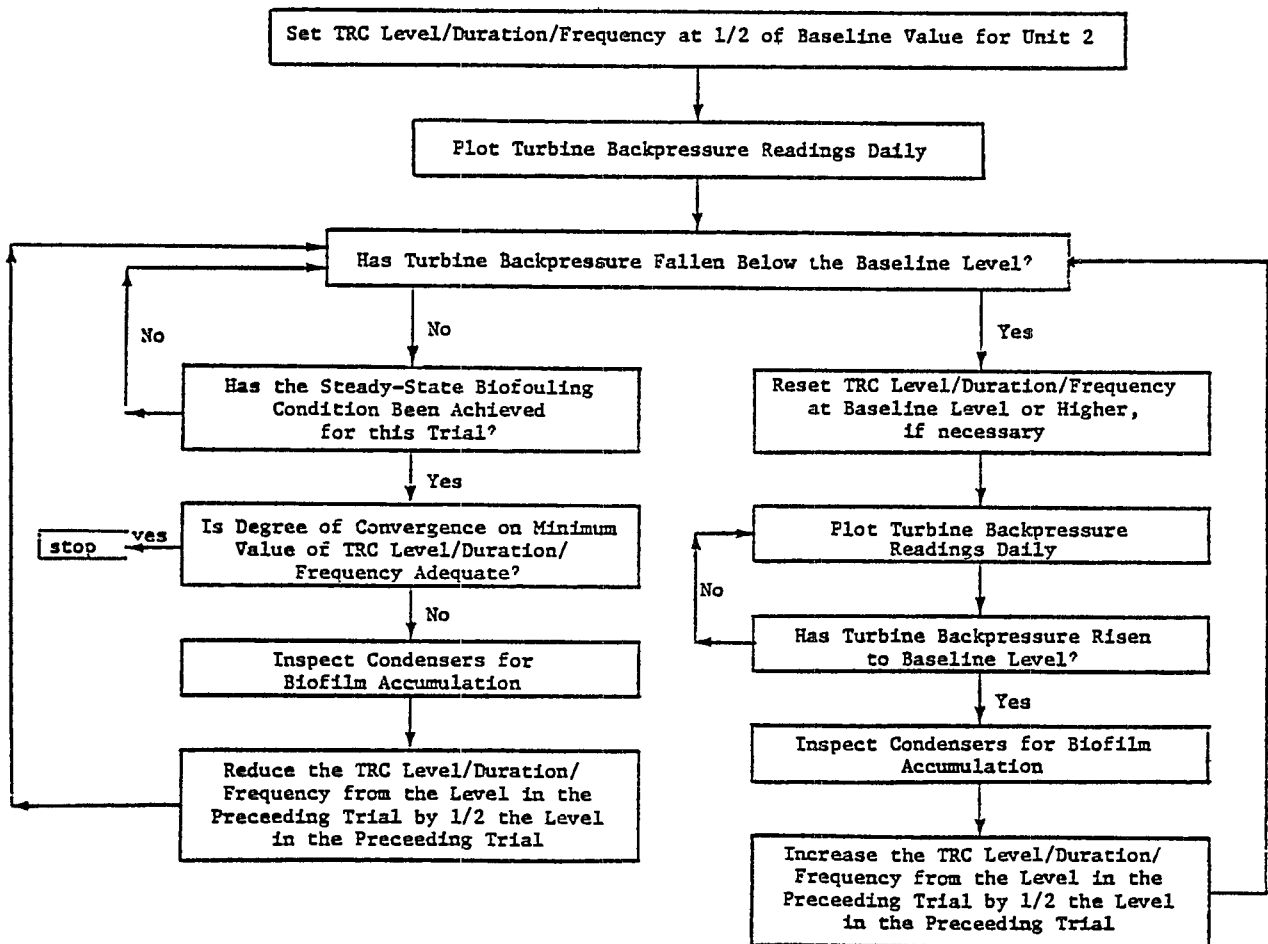

Almost all of the data required to conduct the study are collected as part of the normal operation and maintenance procedure in plants with an adequate chlorination facility. The normal operation and maintenance procedure for the chlorination facility includes daily logging of the chlorine scale readings, daily logging of timer settings, changing the chart on the chlorine residual analyzer, and weekly checks of the analyzer using an amperometric titrator. The normal operation and maintenance procedure for the plant is assumed to include daily logging of cooling water flow, changing charts on the turbine back pressure recorder, and sampling and analysis of intake water quality. The only data not collected as part of normal operation and maintenance procedure is a qualitative evaluation of the degree of biofouling in the condensers. A visual inspection of the condenser can be conducted at the conclusion of each screening trial. The inspection, however, requires taking the condenser out of service, which is very costly in terms of lost power output from the plant.

The performance data are analyzed by correlating intake water quality and chlorine demand, relating chlorine demand to chlorine dosage, and plotting turbine back pressure, TRC level, duration of chlorination, and frequency of chlorination versus time. The analyses are performed at different intervals for each phase of the study. The frequency of analysis is greatest in the second phase since the results of the analyses are used to operate the chlorination facility.

The study procedure is applicable not only to a plant practicing intermittent chlorination but also to a plant practicing continuous chlorination with the addition of a parallel set of steps to determine the minimum dosage required to control biofouling in the intake structure and the pipeline.

#### Implementing Study Recommendations

The final step in the chlorine minimization program is implementing the recommendations of the study. Assuming that the conclusions of the study are that reductions in TRC concentration, duration of chlorination are possible, and frequency of chlorination, the four sets of seasonal minimum values become the permanent basis of chlorination facility operation. The same measurements which were made in the minimization study become part of the data base on plant operation that is generated as standard operating procedure. The analysis of the data is also assigned to the plant operating staff with the assistance of appropriately designed calculation sheets and graph paper. In essence, the chlorine minimization program loses its identity in this final step as it is completely integrated into the normal operation of the plant. A detailed discussion of the necessary

steps in conducting a chlorine minimization program is provided in Appendix B. Appendix D presents the details of the analysis resulting in this conclusion.

### Previous Industrial Applications

Chlorine minimization has been used at a large number of steam electric plants. Data are available for 25 plants which have conducted chlorination minimization studies. Table VII-1 presents the data collected on these plants. From this 25 plant study, the Agency estimates that 63% of all once-through cooling systems that chlorinate (equivalent to 45 percent of all once-through systems) can achieve the 0.20 mg/l TRC limit by chlorine minimization. Appendix D of this document presents the details of the analyses. The industry estimates that 80% of once-through capacity that chlorinates will be able to meet a .20 mg/l TRC limit through minimization.

### Effectiveness

The objective of a chlorine minimization program is to reduce the loading of total residual chlorine (TRC) into the receiving water as much as possible without impairing condenser performance. The degree to which this objective is achieved--the effectiveness of chlorine minimization--is measured in terms of the TRC level at the point of cooling water discharge and the length of time that chlorine is added to the cooling water per day. Data on these two measures of effectiveness were compiled from various studies of efforts to reduce the quantity of chlorine discharged at operating powerplants. Very little data from efforts to reduce the length of time that chlorine is added to the cooling water were found. It should be noted, however, that the current time limitation was not exceeded in any of the studies. An adequate amount of data from efforts to reduce TRC level was found; therefore, an assessment of the effectiveness of chlorine minimization was conducted by analyzing data on TRC levels only.

The TRC data which were extracted from the chlorine minimization and reduction studies were presented in table VII-1. Twenty-five plants, all with once-through cooling water systems, are represented. Nine out of the 25 plants shown in table VII-1 were able to maintain adequate biofouling control at plant discharge levels of 0.1 mg/l or less. Six additional plants were able to achieve TRC discharge levels of 0.2 ng/l or lower.

A statistical evaluation of the effectiveness of chlorine minimization at three Michigan powerplants is presented in Appendix C. On the average, the three plants were able to reduce their effluent TRC concentrations by 40 percent through the use of a chlorine minimization program.

Table VII-1

SUMMARY OF CHLORINE MINIMIZATION STUDIES AT POWER PLANTS  
USING ONCE-THROUGH COOLING SYSTEMS

Plant Number	Number of Units	Chlorine Dosage/Concentration* (mg/l)			Point of Water Dilution	Quality of Cooling Water	Biofouling Problems	References
		Dose	Condenser Outlet	Discharge Point				
1	1	3	NA	<0.1 TRC	Condenser	Seawater	Yes	16, 17
2	1	7 (max)	NA	0.2-0.9 TRC	Condenser	Low TDS	No	16, 17
3	Multiple	NA	2 FAC (max)	<DL	Unit	Low TDS	No	16, 17
4	1	NA	<0.1 TRC	<0.1 TRC	None	Brackish	No	16, 17
5	1	0.6	NA	<0.1 TRC	Condenser + Unit	Seawater	Yes	16, 17
6	1	2.8 (max)	0.8-1 FAC	<0.1 TRC	Condenser + Unit	Seawater	No	16, 17
7	1	NA	0.3-0.5 TRC	0.1 TRC	Condenser	Seawater	No	16, 17
8	1	0	0	0	None	Low TDS	No	16, 17
9	Multiple	NA	NA	0.1 FAC	Condenser + Unit	<500 ppm TDS	No	16, 17
10	1	NA	NA	0.1 FAC	None	<500 ppm TDS	Yes	16, 17
11	1	3.5	0.1-0.2 FAC	<0.1 TRC	Condenser + Unit	Low TDS	No	16, 17
12	1	0.6-1	NA	0.1-0.2 FAC	None	Low TDS	No	16, 17
13	1	0.5	NA	<0.1 TRC	Condenser	Brackish	Yes	16, 17
14	Multiple	3.1	NA	0.2-0.8 TRC	Unit	NA	No	18
15	NA	NA	NA	0-0.2 TRC	NA	NA	No	19
16	NA	NA	NA	0-0.2 TRC	NA	NA	No	20
17	NA	NA	0.5 TRC	NA	NA	NA	No	20
18	NA	NA	1.0 TRC	NA	NA	NA	No	20
19	NA	NA	1.5 TRC	NA	NA	NA	No	13
20	NA	NA	1.0 TRC	NA	NA	NA	No	21
21	NA	NA	0.2 TRC	NA	NA	NA	No	22
22	NA	NA	NA	>0.4 TRC	NA	NA	No	22
23	NA	NA	NA	>0.2 TRC	NA	NA	No	23
24	NA	NA	NA	>0.2 TRC	NA	NA	No	24
25	NA	NA	NA	0.2 TRC	NA	NA	No	24

\*<DL - Less than detection limit  
 FAC - Free Available Chlorine  
 TRC - Total Residual Chlorine  
 NA - Not Available

Reprinted from Costs of Chlorine Discharge Control Options For Once-Through Cooling Systems At Steam Electric Power Plants Draft by Radian Corporation for Effluent Guidelines Division, U.S. Environmental Protection Agency, October 1981

## Reliability

A chlorine minimization program requires close monitoring by the operating staff of a steam electric powerplant to insure that several problems do not arise. First, the likelihood of severe condenser biofouling is increased. If this biofouling does occur, the condenser has to be treated with very high dosages of chlorine or be taken out of service for manual cleaning. Severe biofouling is more likely because there is no measure of condenser performance that unambiguously reflects the formation of biofilm on condenser tubes. The measure of condenser performance selected for the recommended minimization program, turbine back pressure, is affected by factors other than biofilm formation, principally, debris blocking the condenser tubes. The other measures of condenser performance, heat transfer efficiency and pressure drop across the condenser, are similarly affected and require more data to calculate (15). Second, the units on which screening trials are being conducted for the minimization study have to be shutdown for visual inspection of the condenser tubes at the end of each screening trial. The shutdowns reduce the power output of the plant and require more operator time for the shutdown and startup procedures. Unfortunately, no other method of evaluating turbine back pressure readings is available (15). Some of the inspections may be required at times when the units are shutdown for other reasons, thus minimizing the impact of the inspections. Third, the total residual chlorine measurements may be in error when the cooling water is drawn from an estuary. Errors to the high side could cause premature shutdown of the chlorination facility and thus increase the potential for severe biofouling of the condensers. Errors to the low side could create toxic conditions in the receiving stream as a result of the chlorination facility not shutting down when a predetermined level of TRC is exceeded.

The potential operating problems which have been mentioned should be known to the operators of a plant before a chlorine minimization program is begun so that the operators can deal with the problems as effectively as possible.

## Natural Chlorine Demand

### Description of Technology

In a once-through plant, this technology essentially consists of placing the point of chlorine injection directly into or near the condenser inlet box. In an existing plant, this often involves moving the current points of injection from the suction (low pressure) side of the cooling water pumps to the new location near the condenser inlet box (where the water is at high pressure). In a new plant, the chlorination system can be designed to feed into or near the condenser inlet box.



Feeding the chlorine into or near the condenser inlet box may offer any of three distinct advantages depending on plant design. First, less reaction time with the natural chlorine demand of the cooling water will be available before the cooling water reaches the condenser tubes where biofouling control is required. This is because the residence time between the traditional point of chlorine injection (the suction side of the cooling water pumps) and the new point of chlorine injection (into or near the inlet condenser box) has been eliminated. A shorter residence time means less of the free chlorine will react with ammonia, to form chloramines of low biocidal activity, and less of the free chlorine will react with other chlorine demand compounds, to form compounds containing no residual chlorine and having little or no biocidal activity. Since less of the free chlorine is being lost to chlorine demand reactions before reaching the condenser tubes, a lower dose of chlorine will be required to achieve the same concentration of free available chlorine in the condenser tubes. Thus, moving the point of chlorine injection may allow a reduction in the chlorine dose required to maintain adequate biofouling control. For this reason, some reports have referred to moving the points of injection as a chlorine minimization technique. The definition of chlorine minimization contained in this document does not include moving the points of injection.

The second major advantage of locating the points of injection at or near the condenser inlet box is that chlorination can then be done sequentially; each condenser or condenser half is chlorinated by itself, one at a time. The effect of chlorinating sequentially is to provide non-chlorinated water for dilution of the chlorinated water stream. Figure VII-10 illustrates a hypothetical powerplant cooling water system; the points of chlorine injection (before and after the movement of the points) are shown. In this example, there are two condensers, each is split into two separate halves. If the cooling water flow rate through each of the condenser halves is equal, then only one quarter of the cooling water flow will be chlorinated at any one time; three quarters of the flow is available for dilution. From simple dilution then, the concentration of residual chlorine in the final discharge effluent will only be one quarter of the concentration present in the exit line from the chlorinated condenser half.

The third major advantage of locating the points of chlorine injection at or near the condenser inlet box is that the unchlorinated water being used for dilution will also bring about some

dechlorination due to the presence of natural chlorine demand compounds in the unchlorinated water. The extent to which dechlorination removes the remaining free chlorine (after dilution) is a function of the quality of the cooling water and the residence time in the cooling water discharge conduit. Any chloramines formed by reaction of chlorine with ammonia will not be decomposed by any of the natural chlorine demand compounds so some residual chlorine will still be present in the final effluent.

In summary, the application of dechlorination by natural chlorine demand in once-through cooling water systems by moving the points of chlorine injection, offers three potential advantages:

1. Less natural dechlorination before the condenser.
2. More unchlorinated water available for dilution.
3. Some natural dechlorination after the cooling water exits the condenser outlet box.

#### Previous Industrial Applications

Increased usage of natural chlorine demand has been used as an effective TRC control technique in many steam electric plants. No specific data on the number of plants using natural chlorine demand are available.

#### Effectiveness

The effectiveness of dechlorination by natural chlorine demand is extremely site specific. For once-through plants, three factors will tend to increase the effectiveness:

1. The longer the residence time between the present points of chlorine addition and the new points of addition, the more reaction time will be eliminated by moving the points; thus, the larger a reduction in chlorine loss to pre-condenser demand reactions.

2. The larger the number of condensers and the larger the plant megawatt capacity, the more unchlorinated water will be available for dilution, provided all the condenser exit streams are combined before final discharge.

3. The higher the chlorine demand (except ammonia) of the raw cooling water, the more dechlorination will occur upon combination of the chlorinated condenser exit stream with the unchlorinated streams.

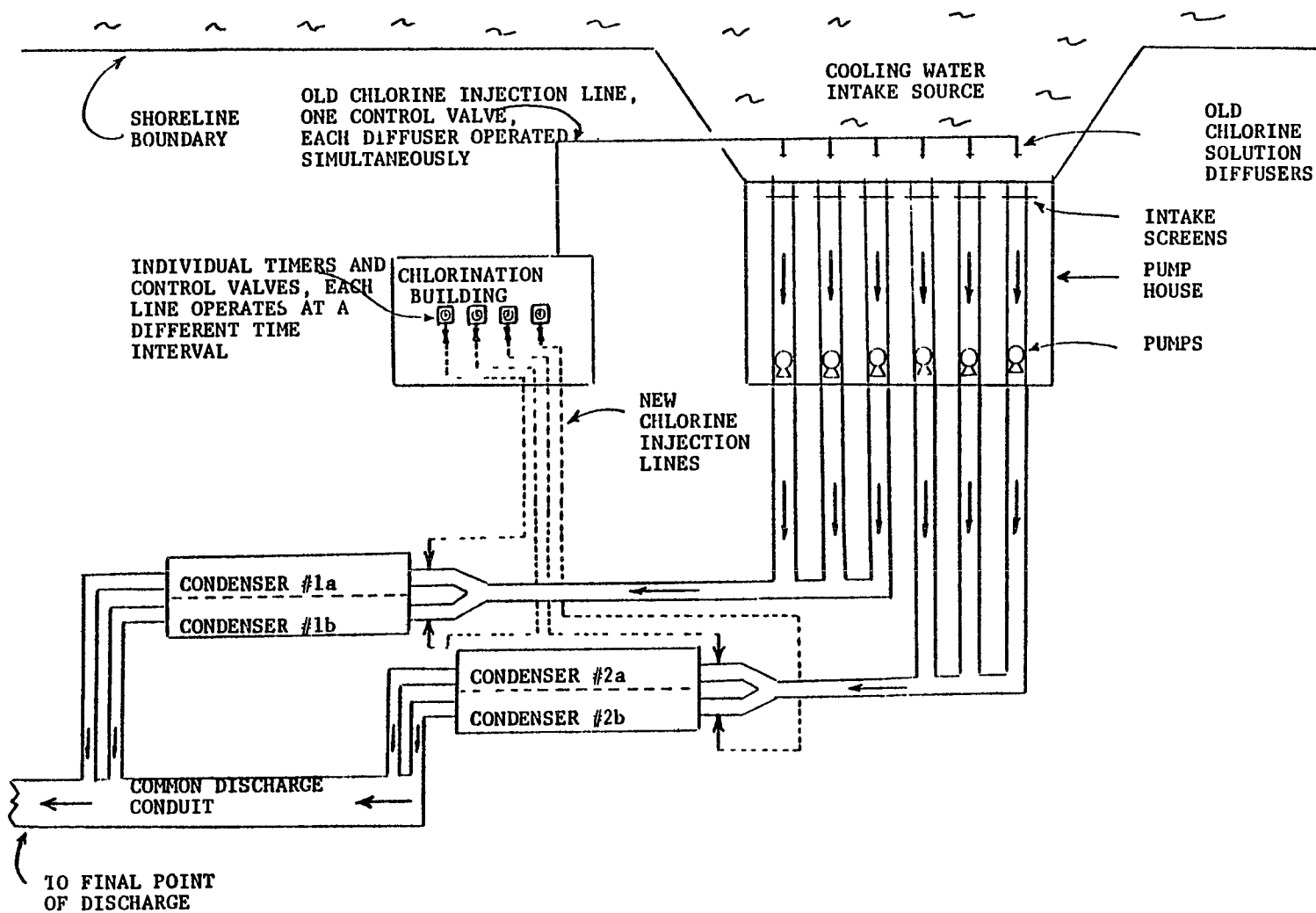

FIGURE VII - 10  
 DECHLORINATION BY NATURAL CHLORINE DEMAND  
 IN A ONCE - THROUGH COOLING WATER SYSTEM

## Reliability

One potential operating problem is immediately apparent when considering dechlorination by natural chlorine demand. In once-through cooling systems, there may be a need for biofouling control in the inlet cooling water tunnel. If the points of chlorine injection are moved from the entrance to the cooling water tunnel to the condenser inlet box, there may be a problem with biofouling in the inlet cooling water tunnels.

## Mechanical Cleaning

### Technology Description

Mechanical means of cooling system cleaning can be used in place of chemical antifoulants. The most obvious method is manual cleaning which requires long plant downtime. Two types of automatic mechanical condenser cleaning systems, which can be used during normal plant operations, are the Amertap and American M.A.N. systems. Diagrams showing the major components of each of these systems are presented in figures VII-11 and VII-12. The Amertap system is the most common type of automatic mechanical cleaning system. By circulating oversize sponge rubber balls through the condenser tubes with the cooling water, the inside of the condenser tubes are wiped. The balls are collected in the discharge water box by screens and repumped to the inlet of the condenser for another pass through the system. They can be used on an intermittent or continuous basis. The American M.A.N. system uses flow drive brushes which are passed through the condenser tubes intermittently by reversing the flow of condenser cooling water. The brushes abrasively remove fouling and corrosion products. Between cleaning cycles, the brushes are held in baskets attached at both ends of each tube in the condenser.

### Previous Industrial Applications

Mechanical cleaning has been widely used in the steam electric industry and in other industries using condensers of similar size. Specific data on the number and location of plants using mechanical cleaning have not been collected.

### Effectiveness

Mechanical cleaning is not always effective in the reduction of TRC discharges. It may be necessary, periodically, to chlorinate the cooling water in addition to the mechanical cleaning. At these times the TRC concentration in the discharge water will increase.

The Amertap and, to a lesser extent, the American M.A.N. system have been reasonably successful in maintaining condenser efficiency and reliability. Some problems are abrasion and grooving of condenser tubes, and, in some cases, the systems themselves become fouled and must be cleaned.

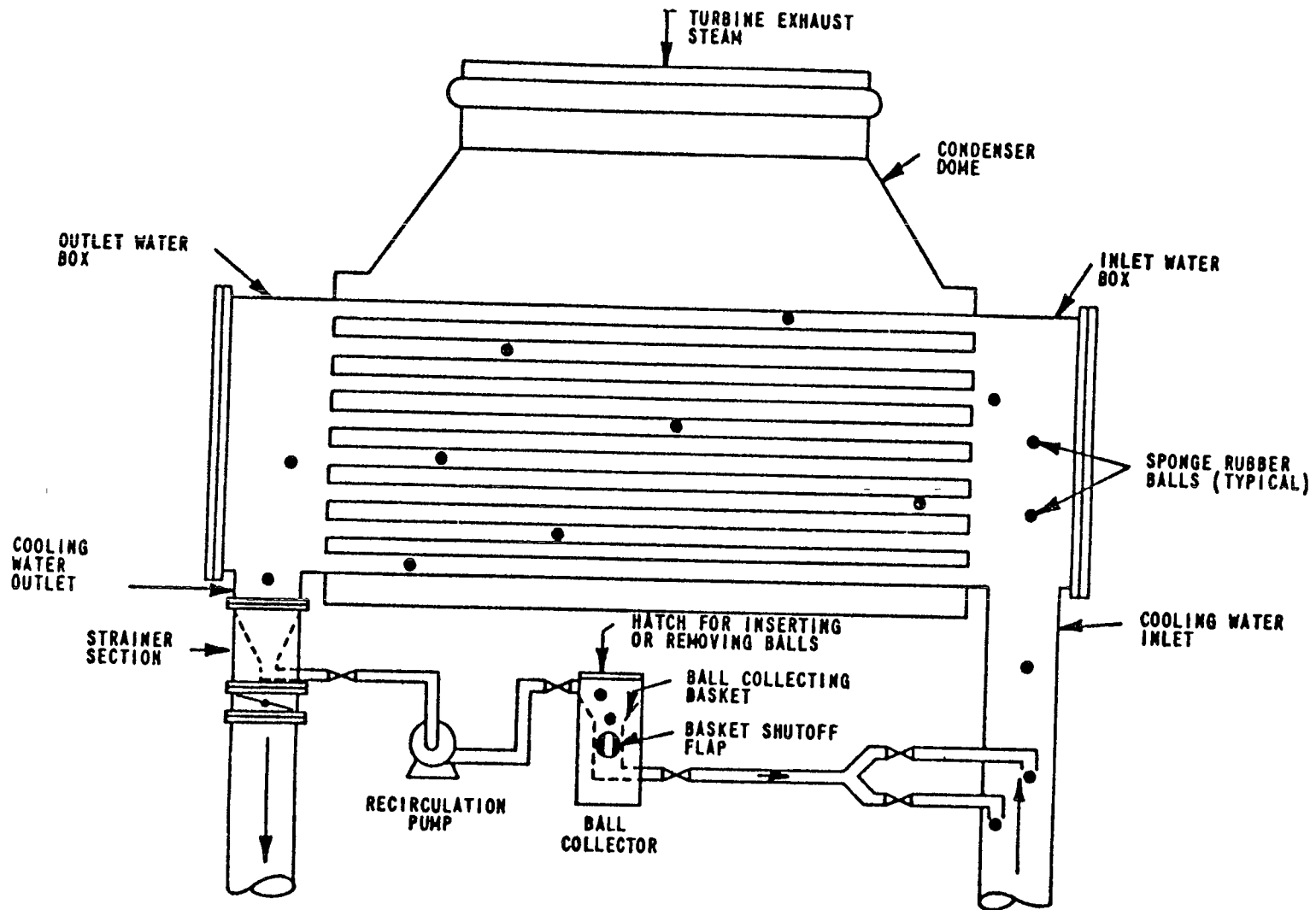
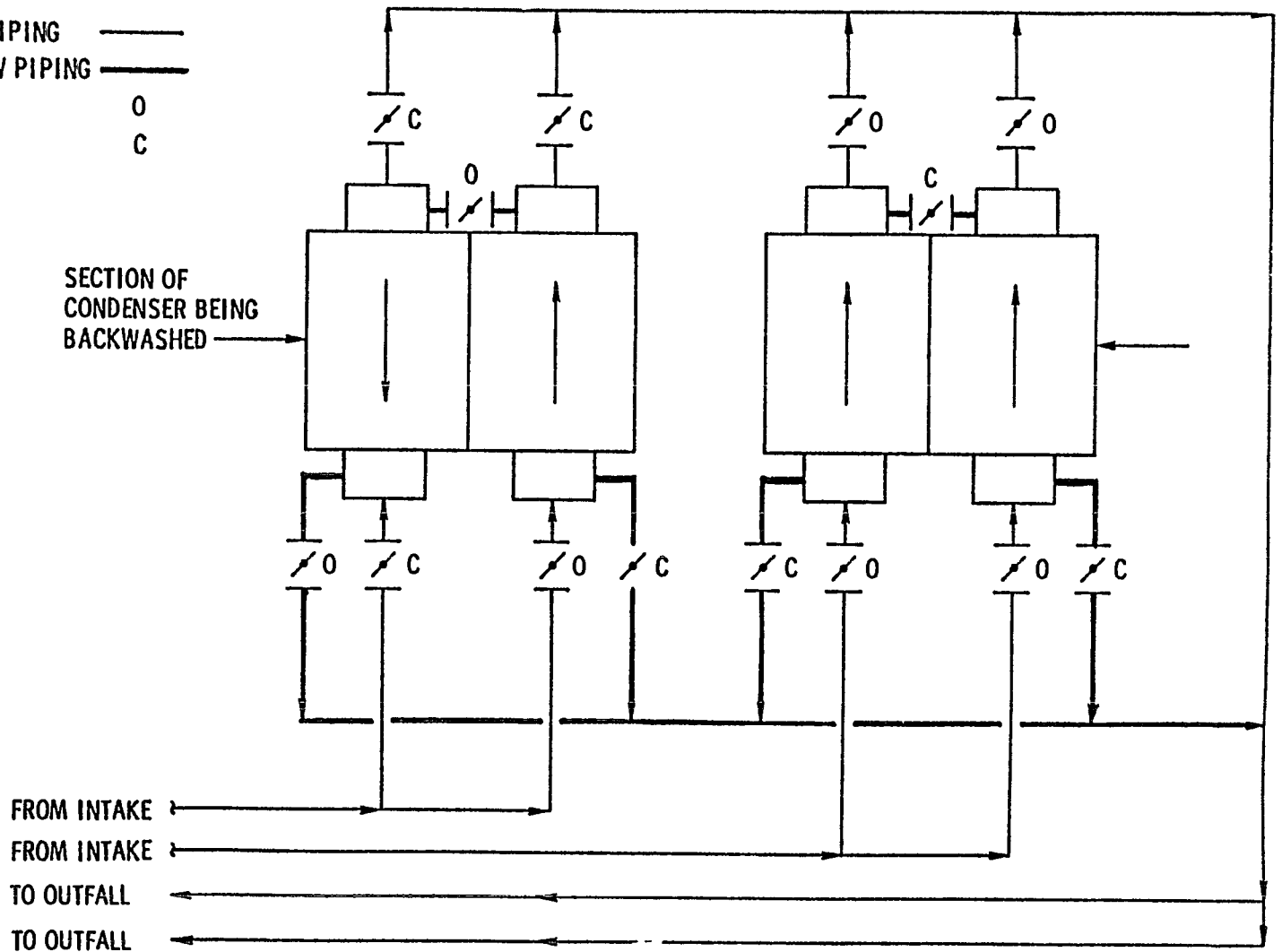

FIGURE VII 11  
 SCHEMATIC ARRANGEMENT OF AMERTAP TUBE CLEANING SYSTEM (25)

NORMAL FLOW PIPING ———  
 BACKWASH FLOW PIPING ———  
 OPEN O  
 CLOSED C



304

FIGURE VII - 12  
 SCHEMATIC OF M A.N SYSTEM REVERSE FLOW PIPING (25)

## End of Pipe Treatment

### Introduction

End of pipe treatment technologies, for the purpose of this report, have been defined as techniques for the reduction or elimination of TRC in once-through cooling water after it leaves the condenser. Technologies which have been evaluated include:

- Dechlorination,
- Vapor compression distillation,
- Evaporation ponds, and
- Complete recirculation.

All technologies other than dechlorination were eliminated from further consideration for various reasons, including:

- The technology was not believed to be applicable to a large population of plants;
- The technology was judged to be too complex to be reliably operated and maintained at a steam electric plant; or
- No data was available to establish the effectiveness of the technology in use at steam electric powerplants or in similar biofouling control applications.

### Dechlorination

Dechlorination is the process of adding a chemical-reducing agent to the cooling water which reduces chlorine to chloride, a non-toxic chemical. There are numerous reducing agents available for this purpose. Only a few have shown themselves to be practical for use in the water and wastewater treatment industry (26):

1. Sulfur Dioxide ( $\text{SO}_2$ )
2. Salts Containing Oxidizable Sulfur
  - a. Sodium Sulfite ( $\text{Na}_2\text{SO}_3$ )
  - b. Sodium Metabisulfite ( $\text{Na}_2\text{S}_2\text{O}_5$ )
  - c. Sodium Thiosulfate ( $\text{Na}_2\text{S}_2\text{O}_3$ )
3. Ferrous Sulfate ( $\text{FeSO}_4$ )
4. Ammonia ( $\text{NH}_3$ )
5. Activated Carbon (C)
6. Hydrogen Peroxide ( $\text{H}_2\text{O}_2$ )

The use of ferrous sulfate, ammonia, activated carbon, or hydrogen peroxide for dechlorination at powerplants has been evaluated and found to be technically or economically infeasible (26). Any dechlorination systems in which these chemicals are used were, therefore, not given further consideration.

### Dechlorination via Sulfur Dioxide

#### Description of Technology

The most common form of dechlorination as practiced in the water and wastewater treatment industry is injection of sulfur dioxide (SO<sub>2</sub>) (11). When injected into water, sulfur dioxide reacts instantaneously to form sulfurous acid (H<sub>2</sub>SO<sub>3</sub>):



The sulfurous acid, in turn, reacts instantaneously with hypochlorous acid (HOCl):

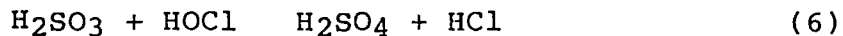

Monochloramine also reacts with sulfurous acid:

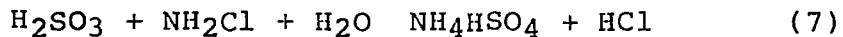

Both dichloramine and nitrogen trichloride are also reduced by sulfur dioxide in similar reactions. The reaction of sulfur dioxide with hypochlorous acid (HOCl) is virtually instantaneous. Reactions with monochloramine and the other combined forms proceed slightly more slowly (27).

The equipment required for dechlorination by sulfur dioxide injection is shown in figure VII-13. As indicated in the figure, a complete system includes the following pieces of equipment:

- SO<sub>2</sub> storage containers,
- expansion chamber-rupture disk,
- SO<sub>2</sub> evaporator,
- SO<sub>2</sub> gas regulator,
- sulfonator,
- ejector,
- ejector pump,
- building for system housing, and
- required timers and control system.

The equipment required for dechlorination by sulfur dioxide injection is identical to the equipment required for chlorination, and the description of chlorination equipment is also applicable to the sulfur dioxide dechlorination system. Equipment manufacturers sell the same equipment for both chlorination and sulfur dioxide dechlorination applications. The capacities of the equipment are different in each application due to differences in the properties of the two gases.



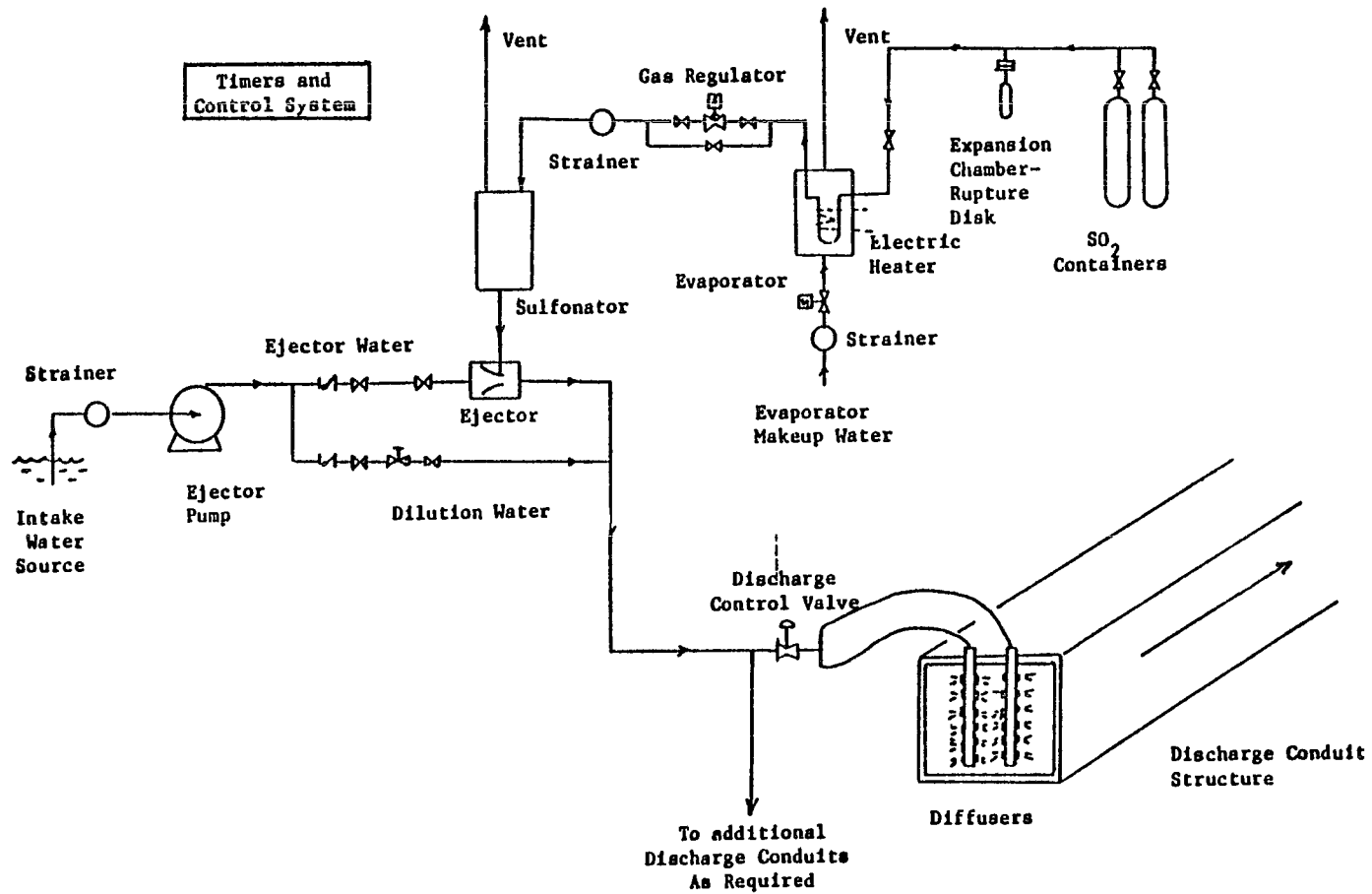

FIGURE VII - 13

FLOW DIAGRAM FOR DECHLORINATION BY SULFUR DIOXIDE (SO<sub>2</sub>) INJECTION

Also shown in figure VII-13 is a typical diffuser assembly installation in a discharge conduit. The number of diffuser installations and the pipe run required to each of the diffusers can vary significantly from plant to plant. If the water in the discharge conduit is in turbulent flow, mixing of the injected solution should be complete in approximately ten discharge conduit diameters. In some plants, this length of pipe may not be available between the point at which sulfur dioxide can be injected and the point at which the effluent cooling water enters the receiving source. Adequate mixing can be provided in even these cases by the proper placement and use of multiple injectors which are commercially available (28), inducement of turbulent flow in the final discharge pipe, or extending the length of the final discharge pipe.

As stated earlier, the number of diffusers required and the length of the pipe runs to each diffuser vary significantly from plant to plant. Proper diffuser placement is essential for complete dechlorination. In order to provide adequate time for mixing and reaction of the  $\text{SO}_2$  with the residual chlorine, it is desirable to locate the diffuser assembly as far upstream from the point of final cooling water discharge as possible. However, no biological fouling control can be expected downstream of the diffuser assembly so in cases where biofouling control is required in the discharge conduit (due to presence of mollusks, asiatic clams, etc.), the diffuser should be located as close to the point of final discharge as possible. In theory, these two opposing constraints are balanced in determining the location of the diffuser assembly. In reality, the location of the diffuser assembly is often fixed by the location of the existing access points in the discharge conduit. Installing the diffuser assembly in an already existing access point (stop log guides, gate shafts) is far less expensive than installing the diffuser assembly by creating a new access point.

Another reason to dechlorinate as far upstream as possible is to minimize the contact time of chlorine with organic matter in the cooling water. Although the kinetics of the formation of chlorinated organics has not been completely defined, it is likely that reducing the chlorine-hydrocarbon contact time will reduce any likelihood of forming chlorinated organics.

#### Previous Industrial Applications

Sulfur dioxide has been used by municipal water and wastewater treatment plants since 1926 (28). Sulfur dioxide dechlorination systems have also been installed or are currently being installed in several United States steam electric plants.

A survey by EPA of the steam electric industry was conducted to identify plants with SO<sub>2</sub> dechlorination experience. This survey and its results were corroborated by industry submittals and a survey conducted by TVA. The identified facilities are listed in table VII-2. As indicated in table VII-2, two of the six identified plants, codes numbers 0611 and 0502, are operating and have effluent data upon which to judge the performance of SO<sub>2</sub> dechlorination technology.

Plant 0611 currently operates a full-scale SO<sub>2</sub> dechlorination system on a once-through seawater cooling unit. This system is operated manually and is successful in removing total residual chlorine from the condenser cooling water discharge. This was corroborated by industry-submitted information and the results of the TVA survey.

Plant 0502 has a 500 mw once-through cooling unit which has an SO<sub>2</sub> dechlorination system. This system is manually operated and was installed in 1970. The system is reported to operate very successfully with minimum problems. No data were provided concerning compliance with the plant's 0.20 mg/l TRC limit, although the characterization of the treatment technique as successful suggests that the plant is meeting a 0.20 mg/l TRC limitation. This plant reportedly meets the limitation on a consistent basis.

### Effectiveness

Municipal treatment plants using sulfur dioxide dechlorination have been able to consistently reduce effluent TRC concentrations to the limit of detection (0.02 mg/l TRC). One reason for this is that a sewage treatment plant is generally dealing with a much lower water flow rate than steam electric plants. This allows a dechlorination contact basin to be used and adequate contact time is insured.

At Plant 0611, an involved study was done to determine the effectiveness of dechlorination by sulfur dioxide injection (29). This plant has a once-through cooling system using salt water. Samples were collected from three streams in the plant: the chlorinated condenser outlet, the unchlorinated condenser outlet and the dechlorinated effluent from the SO<sub>2</sub> dechlorination system. The data are presented in tables VII-3, VII-4 and VII-5. In all cases, the total oxidant residual (TOR) in the dechlorinated effluent was below the limit of detection of 0.02 mg/l. TOR, as compared to total residual chlorine (TRC), measures all free oxidants because the bromine in salt water reacts upon chlorination to form bromine residuals which are also active oxidizing compounds. Amperometric titration does not distinguish between chlorine and bromine residuals.

Table VII-2

SULFUR DIOXIDE DECHLORINATION SYSTEMS IN USE OR  
UNDER CONSTRUCTION AT U.S. STEAM ELECTRIC PLANTS (1)

<u>Plant Code</u>	<u>Discharge Type</u>	<u>NPDES Limits (mg/l)</u>	<u>Status</u>
Plant 2702	Once-through	0.2	New system; dechlorination being used on one unit; no data available.
Plant 0611	Once-through	0.02	Has been successful in removing TRC from the condenser cooling water to meet 0.2 mg/l
Plant 0604	Once-through	0.02	New system; no data available
Plant 0502	Once-through	0.2	System has operated very successfully with minimal problems since 1975

Table VII-3

CHLORINATED CONDENSER OUTLET FIELD DATA  
FROM PLANT 0611 (29)

<u>Test No.</u>	<u>Chlorine Dose* (mg/l)</u>	<u>TOR (mg/l)</u>	<u>pH</u>	<u>D.O. (mg/l)</u>
1	0.85	0.052	7.4	3.9
2	0.82	0.027	7.5	3.7
3	0.85	0.093	7.4	4.9
4	0.83	0.200	7.1	4.7
5	0.72	0.269	7.4	5.4
6	0.83	0.178	7.3	5.0
7	0.81	0.122	7.4	5.8
8	0.81	0.168	7.4	5.5
9	0.80	0.213	7.4	5.4
10	0.80	0.217	7.4	5.4
11	0.80	0.206	7.3	5.4
12	0.81	0.225	7.6	7.0
13	0.87	0.243	7.3	5.4
14	0.87	0.265	7.6	5.5
15	0.87	0.315	7.5	5.1
16	0.87	0.281	7.6	5.2
17	0.88	0.320	7.6	4.8
18	0.89	0.339	7.4	5.1
19	0.88	0.331	7.0	5.0
20	0.85	0.277	7.6	5.3
21	0.85	0.289	7.6	5.4
22	0.82	0.259	7.5	5.0
23	0.85	0.304	7.6	5.0
24	0.42	0.140	7.7	5.3
25	0.85	0.306	7.7	5.4
26	0.81	0.270	7.7	5.0
27	0.81	0.256	7.7	5.4
28	0.83	0.322	7.7	5.2

\*Calculated based on chlorine and cooling water flow rates.

Table VII-4

UNCHLORINATED CONDENSER OUTLET FIELD DATA  
FROM PLANT 0611 (29)

<u>Test No.</u>	<u>TOR (mg/l)</u>	<u>pH</u>	<u>D.O. (mg/l)</u>
1	<0.03	7.6	3.5
2	<0.03	7.3	3.4
3	<0.03	7.5	5.2
4	<0.03	7.4	5.4
5	<0.03	7.2	5.5
6	<0.03	7.4	5.6
7	<0.03	7.4	5.3
8	<0.03	7.4	5.9
9	<0.03	7.4	5.9
10	<0.03	7.4	5.7
11	<0.03	7.4	6.0
12	<0.03	7.0	5.8
13	<0.03	7.4	5.8
14	<0.03	7.5	5.4
15	<0.03	7.5	5.4
16	<0.03	7.7	5.3
17	<0.03	7.7	5.7
18	<0.03	7.4	5.5
19	<0.03	7.7	5.5
20	<0.03	7.7	5.5
21	<0.03	7.6	5.8
22	<0.03	7.6	5.4
23	<0.03	7.7	5.7
24	<0.03	7.7	5.5
25	<0.03	7.7	5.6
26	<0.03	7.6	5.4
27	<0.03	7.7	5.8
28	<0.03	7.7	5.8

Table VII-5

DECHLORINATED EFFLUENT DATA FIELD DATA  
FOR PLANT 0611 (29)

<u>Test No.</u>	<u>TOR (mg/l)</u>	<u>pH</u>	<u>D.O. (mg/l)</u>
1	<0.03	7.4	3.7
2	<0.03	7.6	3.9
3	<0.03	7.4	4.7
4	<0.03	7.4	5.3
5	<0.03	7.4	5.2
6	<0.03	7.3	4.8
7	<0.03	7.4	5.3
8	<0.03	7.4	5.5
9	<0.03	7.4	5.1
10	<0.03	7.4	5.4
11	<0.03	7.4	5.0
12	<0.03	7.4	5.4
13	<0.03	7.3	5.5
14	<0.03	7.4	4.9
15	<0.03	7.5	5.1
16	<0.03	7.6	5.1
17	<0.03	7.6	5.4
18	<0.03	7.4	5.5
19	<0.03	7.7	5.4
20	<0.03	7.7	5.6
21	<0.03	7.6	5.5
22	<0.03	7.4	5.2
23	<0.03	7.7	5.4
24	<0.03	7.6	5.4
25	<0.03	7.7	5.6
26	<0.03	7.6	5.4
27	<0.03	7.7	4.9
28	<0.03	7.7	5.6

The sampling program conducted at Plant 0611 also included analysis of samples for trihalomethanes. Samples were collected from the same three streams as the TOR samples: the chlorinated condenser outlet, the unchlorinated condenser outlet, and the dechlorinated final effluent. The data indicate that chlorination of a once-through brackish cooling water did result in statistically significant increases in total trihalomethane (THM) concentration. The data also indicated that the dechlorinated effluents contained significantly smaller concentrations of THM's than the non-dechlorinated samples. No mechanism for the decomposition of trihalomethanes by dechlorination is known to exist; the lower THM concentrations in the dechlorinated samples were attributed to sampling error. Thus, dechlorination is not expected to have a significant effect on the THM concentrations found in once-through cooling water effluent.

In summary, the available data indicate that state-of-the-art SO<sub>2</sub> dechlorination systems in municipal wastewater treatment plants can bring effluent TRC concentrations down to the detection limit (approximately 0.03 mg/l). Similarly, experience in steam electric power plants, notably at Plant 0611, shows that existing limitations as low as 0.02 mg/l (i.e., not detectable) are being achieved with SO<sub>2</sub> dechlorination.

#### Reliability

The amount of SO<sub>2</sub> required to dechlorinate a given cooling water will vary from plant to plant. A stoichiometric analysis of the sulfur dioxide-chlorine residual reveals that 0.9 milligrams of sulfur dioxide are required to remove 1.0 milligrams of residual chlorine (11). Actual operating experience at one sewage treatment plant suggests that a sulfur dioxide dose rate of 1.1 milligrams of sulfur dioxide per milligram of total residual chlorine will result in proper system performance (27). As was discussed earlier, the concentration of total residual chlorine in the cooling water effluent will depend on the chlorine dose added and the chlorine demand of the influent water. A high quality influent cooling water will require a relatively small dose of chlorine to provide the approximately 0.5 mg/l of free available chlorine (FAC) that is required to control biofouling in the condenser. Since a small dose of chlorine was added to the cooling water to begin with, a small dose of sulfur dioxide will be required for dechlorination.

On the other hand, when a poor quality influent cooling water is used (e.g., high ammonia concentration), a large chlorine dose will be required to achieve the necessary amount of free residual chlorine. This large chlorine dose may result in a high total residual chlorine concentration which, in turn, would require a large dose of sulfur dioxide to remove the chlorine residual. While such situations may require higher dosages of dechlorination chemicals, there is no evidence to suggest that it is either technically or economically infeasible to achieve a TRC limitation of 0.20 mg/l.



In summary, high quality influent water will require small chlorine doses and, in turn, small sulfur dioxide dosages. Low quality, high ammonia influent cooling water is likely to require a high chlorine dose and, therefore, a high sulfur dioxide dose.

There are several potential operating problems with sulfur dioxide dechlorination systems. First, since the vapor pressure of sulfur dioxide is lower than chlorine at the same temperature, the sulfur dioxide has a tendency to recondense in the feed lines between the evaporator and the sulfonator. This problem can be controlled by installing continuous strip electric heaters along the feed line piping.

A second potential problem is pH shift in the effluent. The end products of the reaction of sulfur dioxide with hypochlorous acid are sulfuric acid and hydrochloric acid. Both these compounds tend to lower the pH of the effluent water. Since the total dose of sulfur dioxide is, in most cases, quite small and since the water usually has some natural buffering capability, the pH shift is usually not significant. A statistical analysis of the pH data collected from each of the three streams at Plant 0611 (tables VII-3, VII-4, and VII-5) did not indicate that SO<sub>2</sub> dechlorination was causing any statistically significant change in pH.

Dechlorination may also present the potential problem of increased salinity in the effluent from the addition of dechlorination chemicals such as sulfur dioxide. One study pointed out that the concentration of acids produced from dechlorination of cooling water are on the order of 10<sup>-6</sup> g-mole/l.\* Moreover, no information is available to suggest that such increases in salinity have or would cause adverse environmental effects.

Excess sulfur dioxide may also react with dissolved oxygen (DO) present in the effluent cooling water. This could present a problem since dissolved oxygen must be present in water in concentrations of at least 4 mg/l to support many kinds of fish. However, Sulfur dioxide dechlorination has been practiced at wastewater treatment plants for many years and dissolved oxygen depletion has not been a problem at plants where proper sulfur dioxide dosage control has been practiced. The data collected for dissolved oxygen levels at Plant 0611 (tables VII-3, VII-4, and VII-5) do not indicate that any significant depletion of

---

\*Whitaker and Tan, WPCF, Feb. 1980.

dissolved oxygen is occurring due to SO<sub>2</sub> dechlorination. No other sources of information demonstrate adverse effects due to reduction in DO levels in cooling water discharges.

In summary, some operational problems can and do occur with sulfur dioxide dechlorination systems. However, based upon the information collected and made available to the Agency, with proper equipment maintenance and good process control, sulfur dioxide dechlorination offers an effective method of essentially eliminating the discharge of residual chlorine from power plant effluents without causing demonstrable adverse environmental effects.

### Dechlorination via Dry Chemical Systems

Several sodium salts of sulfur can be used in dechlorination. These compounds are all purchased in bulk volumes as dry chemical solids. They will, therefore, be referred to hereafter by the generic term "dry chemicals."

### Description of Technology

One of the dry chemicals commonly used in dechlorination is sodium sulfite (Na<sub>2</sub>SO<sub>3</sub>). Sodium sulfite reacts with hypochlorous acid as shown in equation 8.

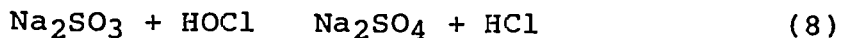

The stoichiometry of this reaction is such that 1.775 grams of sodium sulfite are required to remove 1.0 gram of residual chlorine. Sodium sulfite will also react with the chloramines.

A second dry chemical useful in dechlorination is sodium metabisulfite (Na<sub>2</sub>S<sub>2</sub>O<sub>5</sub>) which dissociates in water into sodium bisulfite as shown in equation 9.

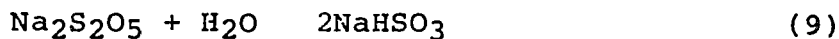

The sodium bisulfite then reacts with the hypochlorous acid as shown in equation 10.

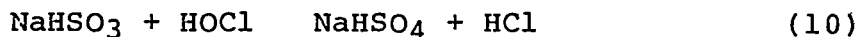

Stoichiometrically, 1.34 grams of sodium metabisulfite are required to remove 1.0 grams of residual chlorine. Sodium metabisulfite reduces chloramines through a similar sequence of reactions.

The third commonly used dechlorination dry chemical is sodium thiosulfate (Na<sub>2</sub>S<sub>2</sub>O<sub>3</sub>). It reacts with hypochlorous acid as shown in equation 11.



The stoichiometric reaction ratio is 0.56 grams of sodium thiosulfate per gram of residual chlorine. Sodium thiosulfate will also reduce chloramines. White (11) does not recommend the use of sodium thiosulfate for dechlorination because it reacts through a series of steps and requires significantly more reaction time than the other dry chemicals. Sodium thiosulfate, however has been used at full-scale steam electric plants so it will be discussed here.

The equipment required for dechlorination by dry chemical injection is shown in figure VII-14. As indicated in the figure, a complete system includes the following pieces of equipment (16):

- loading hopper and dust collector unit,
- extension storage hopper,
- volumetric feeder,
- solution makeup tank and mixer,
- metering pump,
- pressure relief valve, and
- required timers and control system.

Also shown in figure VII-14 is a typical diffuser assembly installation in a discharge conduit.

The chemicals are typically received and stored in 100-pound bags. When necessary, bags are opened and manually dumped into a loading hopper dust collector unit. An extension storage hopper is provided so that bags of chemical need only be loaded on a periodic basis. A volumetric feeder then adds the chemical at a preselected rate into a solution mixing tank. The chemical is mixed with water to form a solution which is then pumped by a metering pump to the required points of injection. If the water in the discharge conduit is in turbulent flow, mixing of the injected solution should be complete in approximately 10 discharge conduit diameters. The dechlorination reaction is generally very rapid but the rate can vary significantly depending on which dry chemical is used. All of the points made earlier about the location of the point of sulfur dioxide injection apply to the point of dry chemical injection. The same is true for the relationship between influent water quality and the required dose of dechlorination chemical.

#### Previous Industrial Applications

Dry chemical injection systems have been or are currently being installed at a number of United States steam electric plants. A list of these facilities is shown in table VII-6.

Industrial experience using dry chemical dechlorination was presented with the sulfur dioxide experience earlier in this section. In its comments, the industry indicated that the dry

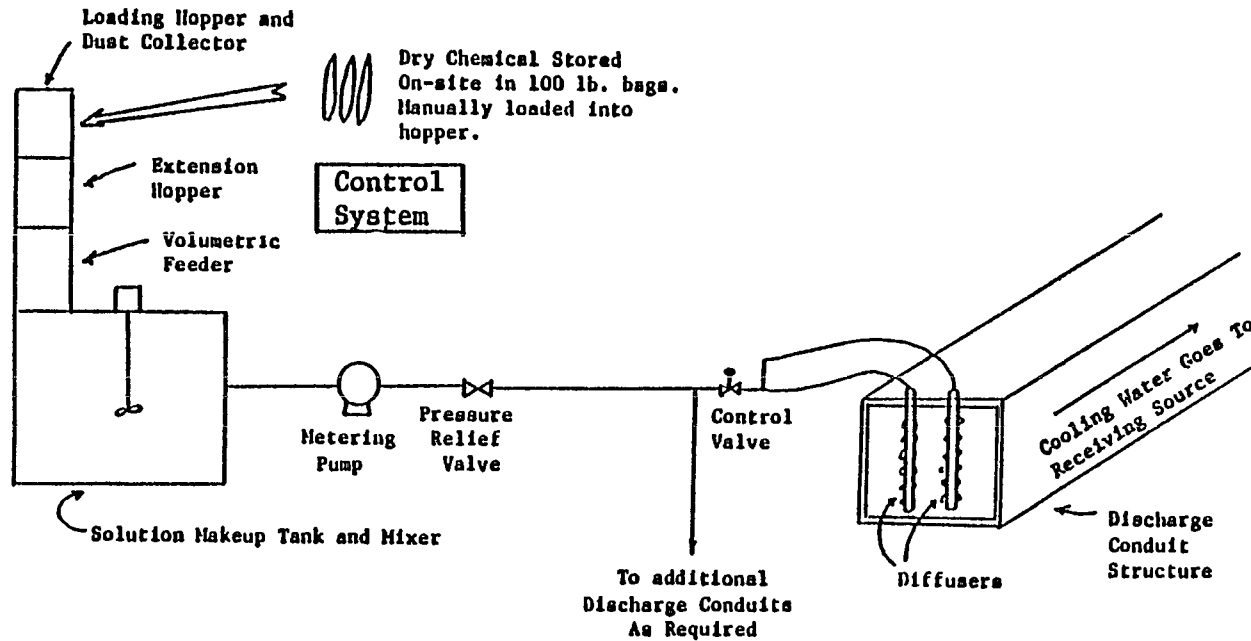

Figure VII-14  
 FLOW DIAGRAM FOR DECHLORINATION BY DRY CHEMICAL INJECTION

Table VII-6

DRY CHEMICAL DECHLORINATION SYSTEMS IN USE OR  
UNDER CONSTRUCTION AT U.S. STEAM ELECTRIC PLANTS (1)

<u>Plant Code</u>	<u>Discharge Type</u>	<u>Dechlorination Chemical</u>	<u>TRC NPDES Limits</u>	<u>Status</u>
2601	Once-through	Sodium sulfite	0.2	Currently shut down
2603	Once-through	Sodium sulfite	0.2	Currently shut down
2607	Once-through	Sodium thiosulfate	0.2	Currently shut down
2608	Once-through	Sodium thiosulfate	0.2	Currently shut down
2619	Once-through	Sodium sulfite	0.04-W* 0.2-S*	Manual system; not yet started up
5513	Once-through	Sodium bisulfite	0.2	Operating since 1977
4107	Once-through	Sodium bisulfite	0.1**	Operating since 1976; operating problems still exist.
0502	Once-through	Sodium sulfite	0.2	Operating since 1970; Systems have operated very successfully with minimal problems.

---

\*W-winter - intake water less than 70°F.

S-summer - intake water greater than 70°F.

\*\*non-detectable concentration.

chemical system at plant 2603 did not work. They concluded that mechanically the system at plant 2603 is a superior system to those at plants 2607 and 2608 and theoretically should work.

Information is available on facilities from the east, midwest and west utilizing dry chemical dechlorination systems. All of these facilities are reportedly meeting the TRC limits in their discharge permits.

### Effectiveness

Three of the plants listed in Table VII-6 were selected for a detailed statistical analysis of their effluent TRC levels over a period of two years. They were the only plants with sufficient data available to conduct a statistical analysis of effluent levels for developing effluent limitations. These were identified by an EPA survey and corroborated by industry submittals and a similar survey conducted by TVA. Data on the operational practices applied at these three plants is provided in Table VII-7. During the two year study period, two chlorination programs were in effect, as follows:

Chlorine Minimization - 1/77 through 10/77  
Dechlorination, - 11/77 through 12/78

Plants 2603, 2607 and 2608 are discussed in detail in the following section. No information is available on Plant 2601, which is now shut down.

Plant 2619 has operated a dry chemical dechlorination system for two years and indicated plans to switch to an SO<sub>2</sub> system. The plant indicated many exceedences of a 0.20 mg/l TRC level in 1980. However, by 1981 the plant was performing significantly better with very few exceedences, characterized by equipment malfunction, abnormal operating procedures, or improper operating procedures.

Plant 5513 installed a dry chemical dechlorination system in 1977 to comply with a 0.2 mg/l TRC limitation reportedly consistent with the limitation.

Plant 4107 has been operating a sodium bisulfite dechlorination system to a TRC level of 0.1 mg/l. The system was installed in 1976. The industry reports that problems have been encountered with the sampling system and the chlorine analyzer. While designed to reduce TRC to non-detectable levels, no discharge data is available.

Plant 0502 has three generating units on dry chemical dechlorination systems. The operators indicate that these systems have been operating very successfully since 1970 with minimum problems in meeting the 0.2 mg/l TRC limits in their permits. Industry commenters identified many of the dry chemical dechlorination systems as primitive, manual, experimental or

Table VII-7

## CHLORINATION/DECHLORINATION PRACTICES (1)

<u>Practice</u>	<u>Plant 2603</u>	<u>Plant 2608</u>	<u>Plant 2607</u>
Dechlorination Chemical	Sodium Sulfite Sodium Thiosulfate	Sodium Sulfite	Sodium Thiosulfate
Dose of dechlorination chemical fed per chlorination period (concentration)	winter .9ppm summer .9 ppm	winter .07 ppm summer .2 ppm	winter .14 ppm summer .3 ppm
Chlorination Chemical	Chlorine Gas	Sodium Hypochlorite	Sodium Hypochlorite
Dose of chlorination chemical fed per chlorination period (concentration of available chlorine)	winter .22 ppm summer 1.06 ppm	winter .04 ppm summer .11 ppm	winter .22 ppm summer .22 ppm
Flow rate of discharge	150,000 gpm	405,000 gpm	214,000 gpm
Reaction time condenser outlet to headwall)	calculated-5 min. actual-4.5 min.	calculated-1-2 min.	calculated-6 min.

temporary. With more sophisticated, permanent installations, it could be expected that many of the identified problems would be eliminated. None of the specific operating or maintenance problems cited are considered unique to water pollution control systems and none of the problems were identified as either insurmountable or as obstacles to achieving a TRC limitation of 0.20 mg/l.

A TVA survey report of industry experience submitted by the industry to EPA in public comments on the proposed regulations, states that "chemical dechlorination does achieve its main goal of reducing TRC to undetectable limits in condenser cooling water discharge. These utilities have proven that chemical dechlorination is a viable technology capable of supporting the power industries' efforts to comply with low-level effluent limitations. Furthermore, chemical dechlorination can be applied to all types of intake water (seawater, freshwater, estuarine water)".

Thus, dechlorination data from discharge monitoring reports (DMR's) are available for each of the three plants (2603, 2608, 2607) for a period of slightly over one year. As detailed in Appendix H, the dechlorination data were analyzed by EPA standard procedures to determine the 99th percentile of the distribution of daily effluent TRC concentrations. The analysis concluded that a 0.14 mg/l TRC is the concentration below which 99 percent of all grab samples taken during periods of simultaneous chlorination and dechlorination would fall. It is concluded that dry chemical dechlorination can effectively control the discharge of TRC to concentrations of 0.14 mg/l or lower with 99 percent reliability.

Because the data provided to EPA were in the form of aggregate statistics (i.e., minimum and maximum sample values, average of sample values, and number of samples per chlorination event) and compliance with the limitations is assessed only when a chlorination event occurs, limitations based on long term average performance and variability factors were not deemed appropriate. The statistical methodology described in Appendix C of the Development Document was developed to address the above cited characteristics of the submitted data while at the same time determining a numerical limitation consistent with the Agency's policy of setting daily maximum limitations based on 99th percentile estimates of the distribution of effluent concentration values.

It is important to note that the dry chemical dechlorination systems in use at Plants 2603, 2607, and 2608 are all "make-shift" systems. The equipment used is basically a 55 gallon drum (used as a mix tank) with a pump and a hose leading to the condenser outlet. Thus, the apparatus constitutes a minimum of sophistication. It follows therefore, that more sophisticated and properly designed and instrumented dechlorination systems



would be capable of achieving much better performance. This is supported, for instance, by the data from Plant 0611 (tables VII-3, VII-4, VII-5) which has a properly instrumented SO<sub>2</sub> dechlorination system. TRC levels in the final effluent from Plant 0611 were consistently below the level of detection.

### Variability

Experience from municipal treatment plants indicates the variability of this technique is small, and a minor factor in its application for TRC control. Plants in the steam electric category using dry chemical dechlorination are able to consistently achieve TRC levels at or below 0.20 mg/l when properly operated.

### Reliability

Potential problems with dry chemical dechlorination systems include pH shift, and oxygen depletion. Table VII-8 presents pH data from four powerplants with dry chemical dechlorination systems. In these four plants, pH shift was not significant and may have been within the error limits of the instrumentation.

Table VII-9 presents additional data from the same four plants using dry chemical dechlorination. The data indicate that dissolved oxygen depletion in the effluent cooling water is not a problem. In no case was the dissolved oxygen lowered by more than 0.6 mg/l.

### SUMMARY

In summary, dry or SO<sub>2</sub> chemical dechlorination is an effective method of eliminating the detectable discharge of residual chlorine from cooling water discharge. Good process control and proper equipment maintenance are necessary for the system to perform optimally. None of the information collected by or submitted to EPA indicates that there are insurmountable problems in process control or equipment operation and maintenance. Such problems are common to all but the most simplistic water pollution control systems. These problems occur continually in well designed and operated systems only during startup and "shakedown" of new systems. Temporary, less well-designed systems, as represented by several of the installed systems described in this section would be expected to experience such problems on a continual basis until they are either properly upgraded or replaced by properly designed and operated systems.

As indicated in this section, such temporary, rudimentary dechlorination systems which experience reportedly continual operating problems have demonstrated the ability to achieve TRC levels of 0.20 mg/l and less. Upgrading to or replacement by permanent, well-designed systems could only result in significantly more efficiency and reliability in meeting the effluent limitation.

Table VII-8

EFFECT OF DRY CHEMICAL DECHLORINATION  
ON PH OF THE COOLING WATER  
(EPA Surveillance and Analysis Regional Data)

<u>Plant Code</u>	<u>pH</u>		
	<u>Intake</u>	<u>Chlorinated</u>	<u>Dechlorinated</u>
2603	8.0	8.4	7.2
2608	7.5	8.1	7.9
2607	8.0	7.9	8.0
5513	7.3	7.3	7.2

Table VII-9

EFFECT OF DRY CHEMICAL DECHLORINATION ON  
DISSOLVED OXYGEN IN COOLING WATER  
(EPA Surveillance and Analysis Regional Data)

<u>Plant Code</u>	<u>Dissolved Oxygen (mg/l)</u>		
	<u>Intake</u>	<u>Chlorinated</u>	<u>Dechlorinated</u>
2603	5.3	NA	7.2
2608	8.1	NA	7.5
2607	7.0	NA	6.6
5513	2.2	2.1	1.9

---

NA - Data not available.

The successful operation of dechlorination systems in various geographies and climates and with widely varying intake water quality (salt water, brackish, fresh water) indicates that these factors have no bearing on the basic ability of dechlorination systems to be installed and to effect chlorine discharge reduction to achieve a discharge TRC level of 0.20 mg/l, or less.

### Pretreatment

Pretreatment of once-through cooling water would be necessary only if the effluent is sent to a POTW. No steam electric plants are known to discharge once-through cooling water to POTW's. Even if once-through cooling water is sent to a POTW, however, pretreatment for TRC removal will not be required since the concentration of TRC found in once-through cooling water would not interfere with the operation of the POTW. TRC levels in the influent wastewaters to a POTW are not significantly related to TRC levels in POTW effluents. However, it is quite unlikely that a POTW would accept the large volumes associated with this waste stream because it would utilize a significant amount of POTW hydraulic capacity which would otherwise be used to treat much more concentrated, lower volume wastes.

### RECIRCULATING COOLING WATER

The blowdown from a recirculating cooling water system may contain any of a number of pollutants which were identified in Section V. Total Residual Chlorine (TRC) and certain priority pollutants are the pollutants in recirculating cooling water blowdown that are of primary interest. This section is broken down into two subsections, one discussing TRC control and the other detailing methods for priority pollutant control.

#### Total Residual Chlorine Control

##### In-Plant Discharge Control

Several techniques for in-plant TRC control in recirculating cooling water systems are available. These include chemical substitutions such as bromine chloride, and chloride dioxide, and improved process control via use of natural chlorine demand. There are no housekeeping practices or manufacturing process changes which are applicable for control of TRC in cooling tower blowdown.

##### Chemical Substitutions

###### Bromine Chloride

The application of bromine chloride for biofouling control in a recirculating cooling water system is the same as its application in a once-through cooling water system. This is true with respect to the technology description, previous industrial applications, effectiveness, variability, and reliability. This material is discussed at the beginning of Section VII.

## Chlorine Dioxide

The use of chlorine dioxide as a biofouling control agent in recirculating cooling water systems is identical to its use in a once-through cooling water system. These two applications of chlorine dioxide are identical with respect to the technology, previous applications, effectiveness, variability, and reliability, and the description given earlier in this Section is applicable to recirculating cooling water systems.

## Ozone

As is the case with all other chemical substitution options, biofouling control with ozone is similar for both once-through and recirculating cooling water systems. All aspects of an ozone biofouling control system are identical for once-through and recirculating cooling water systems. The discussion of ozone biofouling control given earlier in this Section is applicable to this section as well.

## Improved Process Control

### Natural Chlorine Demand

In recirculating cooling systems, the application of dechlorination by natural chlorine demand consists of simply modifying the chlorination procedure currently in use at the plant such that blowdown is not discharged during the chlorination period nor during the period of time after chlorine addition stops when residual chlorine is still present in the recirculating cooling water. Once chlorine addition ceases, the natural chlorine demand reactions will bring about a rapid reduction in the residual chlorine concentration present in the recirculating stream. For example, in a study conducted at Plant 8919, it was found that the total residual chlorine concentration in the recirculating water of a cooling tower dropped to zero 1.5 hours after chlorine dosage was ceased (30). A program of chlorination was adopted such that the cooling tower blowdown valve was closed during the period of chlorination and left closed for the following three hours. A three hour no-blowdown time period was selected in order to insure complete degradation of the total residual chlorine present in the recirculating cooling water. It is expected that this same kind of operation procedure could be successfully applied to recirculating cooling systems using cooling ponds or canals.

In all other respects, previous industrial applications, variability, effectiveness, and reliability, this control method is identical to that presented earlier in this Section for once-through cooling water.

## End-of-Pipe Treatment

There is only one end-of-pipe treatment method which was judged to be technically and economically feasible for reducing or

eliminating TRC in recirculating cooling water blowdown. This is dechlorination which can be accomplished by two different methods: (1) SO<sub>2</sub> injection, and (2) dry chemical systems. Each of these methods is discussed in the subsections which follow.

### SO<sub>2</sub> Injection

The use of SO<sub>2</sub> injection as a means to control TRC concentrations in recirculating cooling water blowdown is similar to its use for once-through cooling water. The discussion of the technology, previous applications, effectiveness, variability, and reliability of SO<sub>2</sub> injection for once through cooling water, presented earlier in this Section, is applicable to recirculating cooling water blowdown.

### Dry Chemical Systems

The application of this control technology to recirculating cooling water systems is identical to its application to once-through cooling water systems. The discussion earlier in Section VII of the technology, previous applications, effectiveness, variability, and reliability is equally applicable to recirculating cooling water blowdown.

Pretreatment of recirculating cooling water blowdown would be necessary only if the effluent is sent to a POTW. No steam electric plants discharge recirculating cooling water blowdown to POTW's. Even if recirculating cooling water blowdown is sent to a POTW, however, pretreatment for TRC removal will not be required since TRC control at POTW's is easily achieved.

### Priority Pollutant Control

Several of the 126 priority pollutants have been observed in cooling tower blowdown. The sources of these priority pollutants are chemical additives used for corrosion, scaling, and biofouling control and asbestos fill material from the cooling towers. The only feasible technology for priority pollutant control is substitution of products not containing priority pollutants for products that do contain these pollutants. Chemical mixtures not containing priority pollutants can be substituted for scaling and corrosion control chemicals and non-oxidizing biocides. These two techniques for the elimination of priority pollutants are in-plant chemical substitutions. Replacement of asbestos cement cooling tower fill with another type of fill eliminates the release of asbestos fibers in cooling tower blowdown. This control technique has been designated as a housekeeping practice and is discussed in the first subsection below.

### In-Plant Discharge Control

There are no manufacturing process changes or improvements in process control that were considered to be technically and economically feasible.

## Housekeeping Practices

### Replacement of Asbestos Cooling Tower Fill

The technology evaluated to control the discharge of asbestos fibers in cooling tower blowdown is replacement of existing asbestos fill material. Existing asbestos cement fill is taken out of the tower and replaced with wood, PVC, or ceramic tiles. This is a straightforward disassembly-and-reassembly construction procedure. The tower is, of course, out of service during this construction activity.

The cost for asbestos cement fill replacement is extremely site-specific. Factors such as the current fill configuration, plant location, fill chosen for replacement, local labor wages and availability, proximity to appropriate asbestos fill disposal site and time available for fill replacement (cooling tower must be out of service) all affect the cost of fill replacement. The general range of the fill replacement costs can be estimated from repair work done by cooling tower manufacturers in the past. In one such case, the existing asbestos cement fill was damaged due to problems with the water chemistry of the recirculating water. This resulted in the leaching of calcium carbonate from the asbestos cement which brought about rapid fill deterioration. In another case, water freezing in the fill brought about serious damage. In both instances, complete fill replacement was necessary.

## Chemical Substitutions

### Alternative Corrosion and Scaling Control Chemicals

The principal control technology available to eliminate the discharge of priority pollutants as a result of the use of corrosion and scale control agents is the substitution of corrosion and scaling control agents which do not contain priority pollutants. Most powerplants usually purchase the chemicals they need for corrosion and scaling control from vendors as prepackaged mixtures. The exact composition of these "proprietary" mixtures is confidential but a partial listing of some of the commonly used mixtures which do contain priority pollutants is given in Table VII-10. At least one vendor is now offering a corrosion and scaling control mixture that contains neither zinc nor chromium and has proven very effective in several full scale test programs in various industrial applications (32).

### Alternative Non-Oxidizing Biocides

Many steam electric powerplants use non-oxidizing biocides instead of, or in conjunction with, the oxidizing biocides. The non-oxidizing biocides are also effective in controlling bio-fouling but do so through mechanisms other than direct oxidation of cell walls.

Table VII-10

CORROSION AND SCALING CONTROL MIXTURES  
 KNOWN TO CONTAIN PRIORITY POLLUTANTS (31, 32)

<u>Compounds Known to Contain Priority Pollutants</u>	<u>Specific Priority Pollutants Contained in Product</u>
<u>NALCO CHEMICALS</u>	
25L	Copper
38	Chromium
375	Chromium
<u>CALGON CHEMICALS</u>	
CL-70	Zinc Chloride
CL-68	Sodium Dichromate, Zinc Chloride
<u>BETZ CHEMICALS</u>	
BETZ 40P	Chromate and Zinc Salts
Dianodic 191	Chromate and Zinc Salts
<u>HERCULES CHEMICALS</u>	
CR 403	Zinc Dichromate, Chromic Acid
<u>BURRIS CHEMICALS</u>	
Sodium Dichromate	Sodium Dichromate



A list of most of the commonly used oxidizing biocides is presented in Table VII-11. Note that there are really two kinds of oxidizing biocides. The first group are appropriate for use in large-scale applications and require expensive feed equipment. These compounds have all been thoroughly discussed earlier and no further discussion will be presented here.

The second group of oxidizing biocides are commonly purchased from suppliers as a liquid or solid in small containers (i.e., 50 gallon drums, 100 pound bags). These biocides are fed using relatively simple feed equipment (solution tank, mixer, pump, diffuser) and in some cases are simply dumped into the influent lines to the cooling system. Note that many of these compounds contain chlorine which is released upon solution in water to form hypochlorous acid (free available chlorine). The use of chlorine in this form will create the same problems as injection of chlorine gas, the only difference being the method in which the chlorine was introduced to the system. Plants using the "chlorine bearing" compounds will have to meet the same effluent standards as plants injecting chlorine gas. Both chlorine minimization and dechlorination are technologies available to help a plant meet total residual chlorine limitations.

A third possibility for biofouling control is the substitution of a "non-chlorine bearing" oxidizing biocide which may offer similar biofouling control but will not result in the discharge of residual chlorine. For example, a plant currently using calcium hypochlorite could switch to dibromonitripropionamide (DBNPA) and avoid the discharge of residual chlorine altogether.

Another substitution available to the plant is to use a non-oxidizing biocide instead of an oxidizing biocide. A list of the commonly used non-oxidizing biocides is presented in table VII-12. As the table shows, a diversity of products have been used for this purpose. An advantage that non-oxidizing biocides have over their oxidizing counterpart is their slow decay. Oxidizing biocides are, by design, very reactive compounds. As a result, the oxidizing biocides react with many contaminants present in the cooling water and rapidly decay to relatively non-toxic compounds. The non-oxidizing biocides are, by design, very toxic materials which react selectively with microorganisms and other life forms. They may decay very slowly once released to the environment and thus pose a substantial environmental hazard.

Many of the non-oxidizing biocides are priority pollutants. If a compound is a known priority pollutant it is marked with an asterisk to the left of the compound name. Since there are many non-priority pollutant, non-oxidizing compounds readily available on the marketplace, it is not recommended that priority pollutants be used for this purpose.

Before searching for a substitute for the current biocide a plant is using, careful examination should be given for the need of biocides at all, especially non-oxidizing biocides.

Table VII-11

COMMONLY USED OXIDIZING BIOCIDES (33, 34)

Group A - Appropriate for Use in Large Scale Applications,  
Require Expensive Feed Equipment

Bromine chloride  
Chlorine  
Chlorine dioxide  
Ozone

Group B - Appropriate for Use on Intermittent Basis or in Small  
Systems, May Not Require Expensive Feed Equipment

Ammonium persulfate  
Bromine  
Calcium chlorite  
Calcium hypochlorite  
Dibromonitrilopropionamide  
2,2-dichlorodimethyl hydantoin  
Iodine  
Potassium hydrogen persulfate  
Potassium permanganate  
Sodium chlorite  
Sodium dichloroisocyanurate  
Sodium dichloro-s-triazinetriene  
Sodium hypochlorite  
Trichloroisocyanuric acid

NOTE: None of these compounds are priority pollutants.

Table VII-12

COMMONLY USED NON-OXIDIZING BIOCIDES \*(33, 34)

\*Acid copper chromate  
 \*Acrolein  
 n-alkylbenzyl-N-N-N-trimethyl ammonium chloride  
 n-Alkyl (60% C , 30% C , 5% C , 5% C ) dimethyl benzyl  
 Ammonium chloride  
 n-Alkyl (50% C , 30% C , 17% C , 3% C ) dimethyl ethylbenzyl  
 ammonium chloride  
 n-Alkyl (93% C , 2% C ) dimethyl-1-naphthylmethyl ammonium  
 chloride  
 alkylmethylbenzylammonium lactate  
 Alkyl-9-methyl-benzyl ammonium chloride  
 n-Alkyl (C - C ) - 1,3-Propanediamine  
 \*Arsenous Acid  
 \*Benzenes  
 Benzyltriethylammonium chloride  
 Benzyltrimethylammonium chloride  
 Bis-(tributyltin) oxide  
 Bis-(trichloromethyl) sulfone  
 Bromonitrostyrene  
 Bromostyrene  
 2-bromo-4-phenylphenol  
 \*Carbon tetrachloride  
 Cetyldimethylammonium chloride  
 Chloro-2-phenylphenol  
 2-chloro-4-phenylphenol  
 \*Chromate  
 \*Copper Sulfate  
 \*Cromated copper arsenate  
 \*Cresote  
 \*Cyanides  
 3,4-dichlorobenzylammonium chloride

Table VII-12 (Continued)

COMMONLY USED NON-OXIDIZING BIOCIDES (33, 34)

\*2,4-dichlorophenol  
Dilauryldimethylammonium chloride  
Dilauryldimethylammonium oleate  
Dimethyltetrahydrothiadiazinethione  
Disodium ethylene-bis-(dithiocarbamate)  
Dodecyltrimethylammonium chloride  
Dodecyl dimethyl ammonium chloride  
Dodecyl guanidine acetate and hydrochloride  
Isopropanol  
\*Lactoxymercuriphenyl ammonium Lactate  
Lauryldimethyl-benzyl-diethylammonium chloride (75%)  
Methylene bithiocyanate  
Octadecyltrimethylammonium chloride  
\*Phenylmercuric triethanol-ammonium lactate  
\*Phenylmercuric trihydroxethyl ammonium lactate  
o-phenylphenol  
Poly-(oxyethylene (dimethylimino) ethylene-(dimethylimino)  
ethylene dichloride)  
Sodium dimethyldithiocarbamate  
\*Sodium pentachlorophenate  
\*Sodium trichlorophenate  
2-tertbutyl-4-chloro 5-methyl phenol  
2,3,4,6-tetrachlorophenol  
Trimethylammonium chloride  
\*Zinc salts

---

In addition to the above chemicals the following may be present as solvents or carrier components:

Dimethyl Formamide  
Methanol

Table VII-12 (Continued)

COMMONLY USED NON-OXIDIZING BIOCIDES (33, 34)

Ethylene glycol monomethyl ether  
Ethylene glycol monobutyl ether  
Methyl Ethyl Ketone  
Glycols to Hexylene Glycol  
\*Heavy aromatic naphtha  
Cocoa diamine  
Sodium chloride  
Sodium sulfate  
Polyoxyethylene glycol  
Talc  
Sodium Aluminate  
Mono chlorotoluene  
Alkylene oxide - alcohol glycol ethers

NOTE: \*Indicates the compound is known to contain a priority pollutant. Some of the other compounds may degrade into priority pollutants but no data was available to make a definite determination.

In those recirculating plants using cooling towers with wood fill, a special biofouling problem exists. It is only in these systems in which the use of non-oxidizing biocides is really justified (1). The problem is that the wood fill is susceptible to fungal attack in the center of the boards. Chlorine doses high enough to provide microbial control at the center of the boards would result in the delignification of the lumber and destroy the wood's structural strength. Thus, a nonoxidizing biocide offers a perfect solution. For this reason, lumber used in cooling tower fill is often pre-treated with a non-oxidizing biocide. Pentachlorophenate and various trichlorophenates are frequently used for this purpose (33). Both pentachlorophenate and the trichlorophenates are priority pollutants.

#### End-of-Pipe Treatment

There are no end-of-pipe treatment technologies which were judged to be technically and economically feasible to implement.

#### Pretreatment

In plants where cooling tower blowdown is discharged to a POTW, pretreatment is required for the removal of priority pollutants. The recommended pretreatment technology is chemical substitution which has been discussed in the section entitled Chemical Substitutions.

#### ASH HANDLING

Systems for handling the products of coal combustion by hydraulic or pneumatic conveyors have been used for 50 years or more. With the advent of larger steam generation units, larger ash handling systems have been built with heavier components to cope with the increased loads. Powerplant refuse, which can be classified as ash, falls into four categories (36):

- o Bottom ash (dry or slag)--material which drops out of the main furnace and is too heavy to be entrained with the flue gases;
- o Fly ash--finer particles than bottom ash which are entrained in the flue gas stream and are removed downstream via dust collecting devices such as electrostatic precipitators, baghouses, and cyclones;
- o Economizer and air preheater ash--coarser particles which drop out of flue gases as a result of changes in direction of the flue gas; and,
- o Mill rejects, or pyrites--variety of coarse, heavy pieces of stone, slate, and iron pyrite which are removed from coal during preparation stages (at plants which clean the coal prior to use).

Economizer and air preheater ashes are usually collected in hoppers and transported in conjunction with fly ash to a disposal site; thus, fly ash transport systems are considered to apply to the economizer and preheater ash as well. Mill rejects are wastes encountered in coal preparation which is usually performed off site; therefore, mill reject transport systems are treated as off site operations and are not addressed in this discussion. As a result, only bottom ash and fly ash handling systems are considered in this subsection.

Statistics for 1975 indicate that approximately 410 million tons of coal were burned, producing nearly 41 million tons of fly ash and 22 million tons of bottom ash and boiler slag (37). As coal use increases to replace the dwindling supplies of other fuels used for generating electric power, the amounts of fly ash and bottom ash requiring proper disposal will also increase. Perhaps the most environmentally acceptable and economically attractive method of disposal is through utilization as a raw material in the manufacture of new products. Recently fly ash and other coal residues have found uses such as lightweight aggregates for construction, structural fills, embankments, or low-cost highway base mixes. Ash also has been successfully used as a soil amendment, in fire-control or fire-abatement procedures, and for treatment of acid mine drainage. Since ash is typically high in concentrations of many metals such as copper, vanadium, aluminum, chromium, manganese, lead, zinc, nickel, titanium, magnesium, strontium, barium, lithium, and calcium, it may serve as an important source of these metals in the near future (38). Thus far, however, the use of fly ash and bottom ash in manufacturing has been relatively small, only 16.3 percent in 1974 (38); therefore, the major portion of the fly ash and bottom ash resulting from coal combustion must be disposed.

### Fly Ash

The treatment and control technologies applicable to fly ash handling systems are:

- o dry fly ash handling;
- o partial recirculation fly ash handling; and
- o physical/chemical treatment of ash pond overflows from wet, once-through systems.

### Dry Systems

Dry fly ash handling systems are pneumatic systems of the vacuum or pressure type. Vacuum systems use a vacuum, produced by ejectors or mechanical blowers, to provide the necessary air flow to convey ash from the electrostatic precipitator (ESP) hoppers to its destination point, i.e., a dry storage silo or landfill. Pressure systems, on the other hand, make use of pressure blowers

to provide the required air flow for ash conveying. In general, a vacuum system is more limited in conveying distance than a pressure system; thus, vacuum systems are generally not used for systems covering distances greater than 500 to 700 feet (39). Controls for a vacuum system are generally simpler than those for a pressure system. This can be advantageous for systems which have a large number of ash hoppers, e.g., 35 to 40. Because dry fly ash systems eliminate the need for an ash sluice water discharge, they represent a means of achieving zero discharge.

Vacuum Systems. In this type of system, fly ash is pneumatically conveyed to a dry storage silo by means of a mechanical vacuum producer. An example of a vacuum system for dry fly ash is shown in figure VII-15. Fly ash is drawn from the bottom of the ash hopper through the dust valves and segregating valves to the primary and secondary collectors above the dry storage silo. The dust-free air from the collectors is sent through a cartridge filter before it is allowed to pass through the mechanical blowers where it is vented to the atmosphere.

Vacuum systems are limited in conveying distance. The distance to which material can be conveyed depends on the configuration of the system and plant altitude above sea level. The application of vacuum systems is generally limited from 500 to 700 feet of distance from the ash hoppers to the dry storage silos (39). The simplicity of vacuum systems makes them particularly advantageous in systems with 35 to 40 ESP hoppers.

Equipment. The following list of equipment comprises the major components of a vacuum system:

- o vacuum producers--mechanical or hydraulic;
- o valves--type "E" Dust Valves and segregating valves;
- o conveying pipe;
- o dry storage--silo, dust collectors, and vent filters;
- o dust conditioners (or unloaders); and
- o controls.

Many vacuum systems use mechanical exhausters to provide the necessary vacuum to convey fly ash to the dust collectors. These mechanical exhausters are 300- to 400-hp blowers (39), which are similar to those used in pressure systems. Vacuum production may also be provided by mechanical vacuum pumps motor driven machines of either the dry or water-injected positive displacement type or the water sealed rotary bucket type. Experience has shown that water-injected lobe type positive displacement vacuum producers cannot be used in cases where flue gases are high in sulfur dioxide (40). In such cases, dry vacuum pumps or watersealed



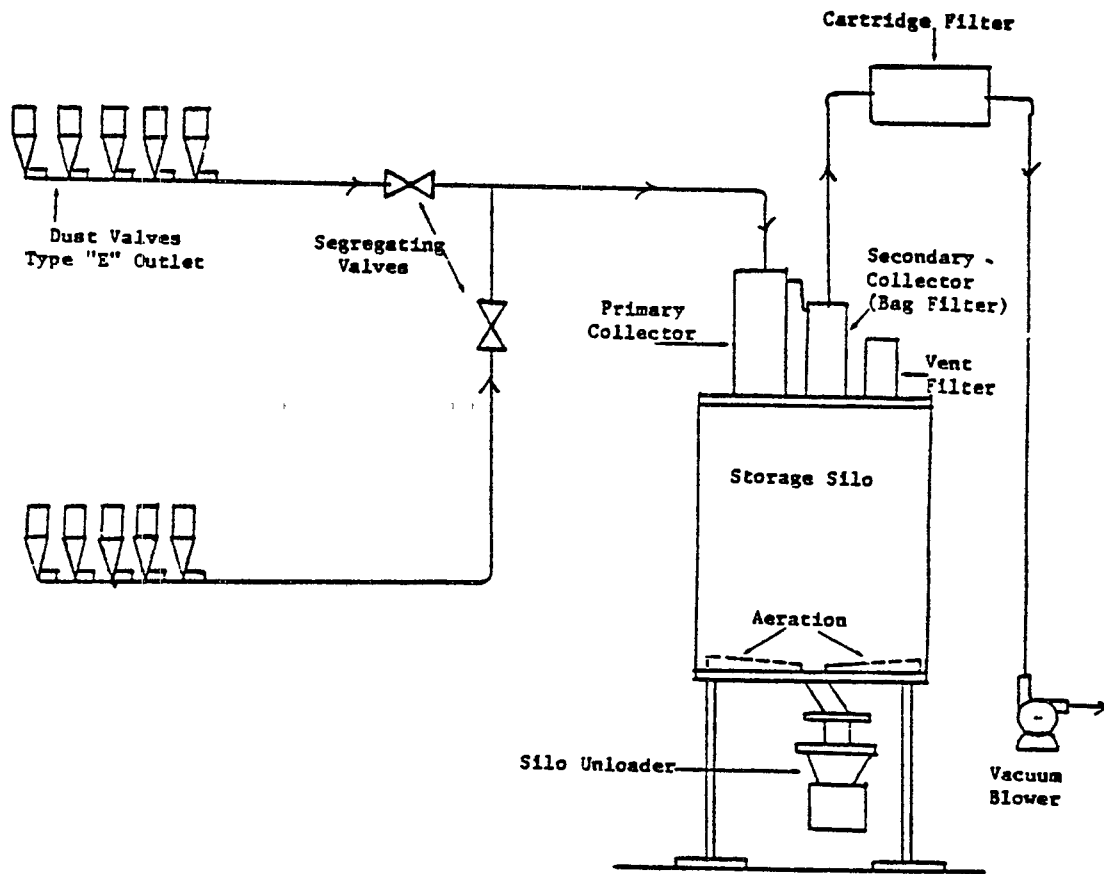

Figure VII-15  
 DRY FLY ASH HANDLING - VACUUM SYSTEM

machines must be used to avoid corrosion. The use of any mechanical vacuum pump requires the installation of collecting equipment of the highest possible efficiency ahead of the pump.

Figure VII-16 presents a diagram of a hydraulic vacuum producer. This particular unit, marketed under the trade name "Hydrovac-tor," is manufactured by the Allen-Sherman-Hoff Company. The hydrovac-tor makes use of high-pressure water (from 100 to 300 psi) discharged through an annular ring of nozzles into a venturi throat to create the vacuum to convey dust to the collectors (40). A similar unit, known as a "Hydroveyor," is manufactured by United Conveyor Corporation. The amount of water required, the pressure of the water, and the extent of the vacuum produced are a function of the ash generating rate and distance to the storage silo. Typical values might be 1,500 gpm of water through the venturi to draw 100 pounds per minute of air at 13 inches of mercury (39).

Figure VII-17 illustrates the type "E" dust valve which is installed under the fly ash collection hoppers. This valve is air-electric operated and is designed to admit ambient air through integrally mounted inlet check valves. As the slide gate is opened, air drawn through these valves and from the interstices in the dust becomes the conveying medium which transports the fly ash. Valve opening and closing is controlled by fluctuations in the vacuum at the producer. A drop in vacuum indicates an empty hopper, so that an operator, or an automatic control device, is alerted to move to the next point of dust collection.

When the fly ash is conveyed from two or more branch lines, segregating valves are used to block off any branched lines which are not in use. By isolating the lines in this manner, the full energy of the conveying air can be applied to one branch at a time without the possibility of loss of conveying capacity due to leaks in other branches. Segregating valves may be provided with chain wheel or hand wheel operators as well as air-electric operators as shown in figure VII-18.

There are three types of pipe generally used in ash handling:

- o carbon steel pipe,
- o centrifugally cast iron pipe, and
- o basalt-lined pipe.

In general, the carbon steel and centrifugally cast iron pipes are most commonly used for dry handling (39). Basic pipe for ash handling service have a Brinnell Hardness Number (BHN) of 280; fittings are harder (approximately 400 BHN) to combat the added abrasive action at bends in a conveying line (40). Typical pipe and fittings are shown in figure VII-19. Integral wear back, tangent end fittings are used. A line of fittings with replaceable

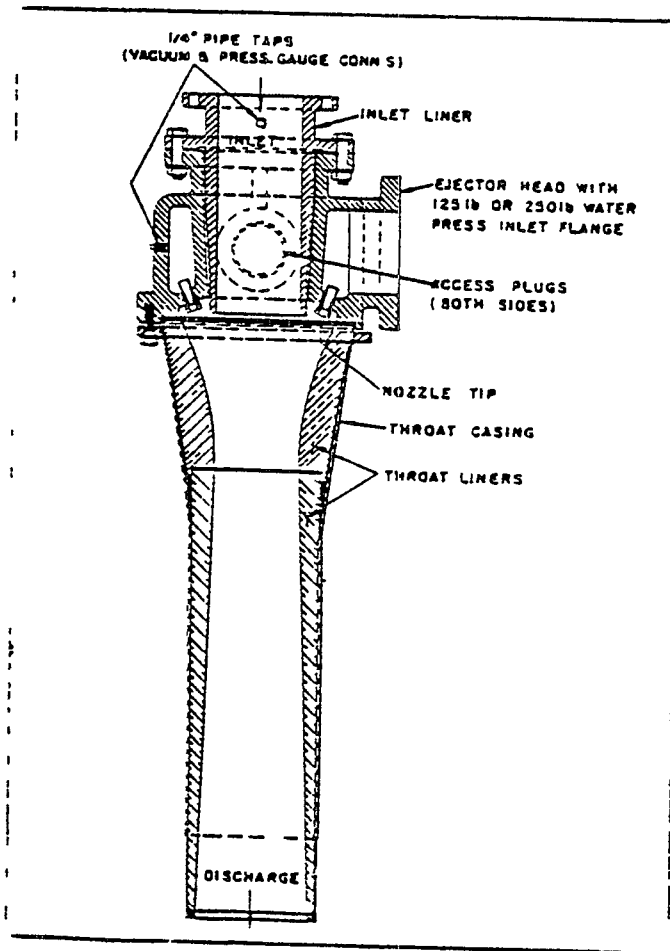

Figure VII-16

DIAGRAM OF A HYDRAULIC VACUUM PRODUCER

Reprinted from A Primer for Ash Handling by Allen-Sherman-Hoff Company by permission of Allen-Sherman-Hoff Company, A Division of Ecolaire. Year of first publication 1976.

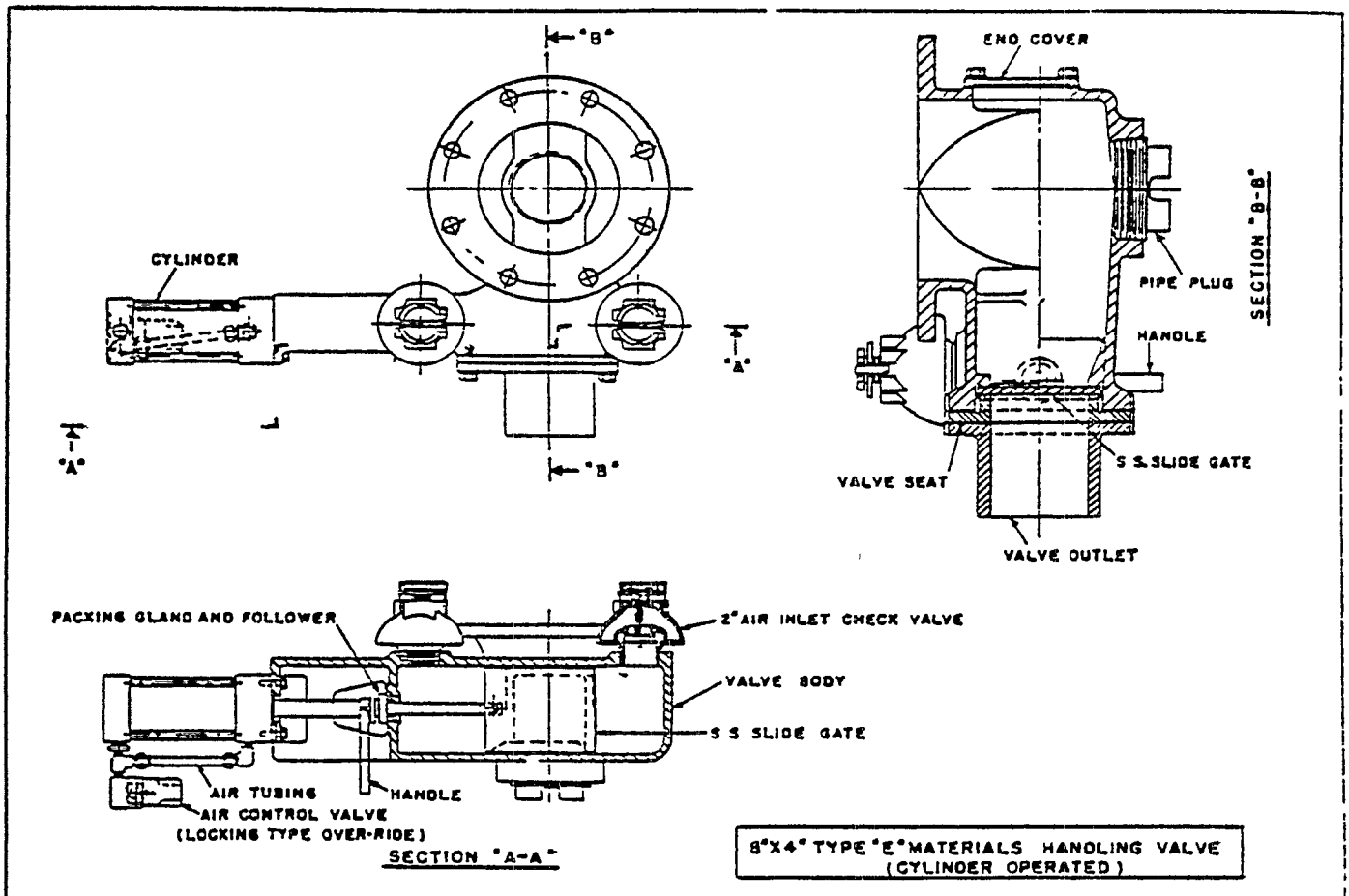

Figure VII-17

TYPE "E" DUST VALVES

Reprinted from A Primer for Ash Handling by Allen-Sherman-Hoff Company by permission of Allen-Sherman-Hoff Company, A Division of Ecolaire. Year of first publication 1976.

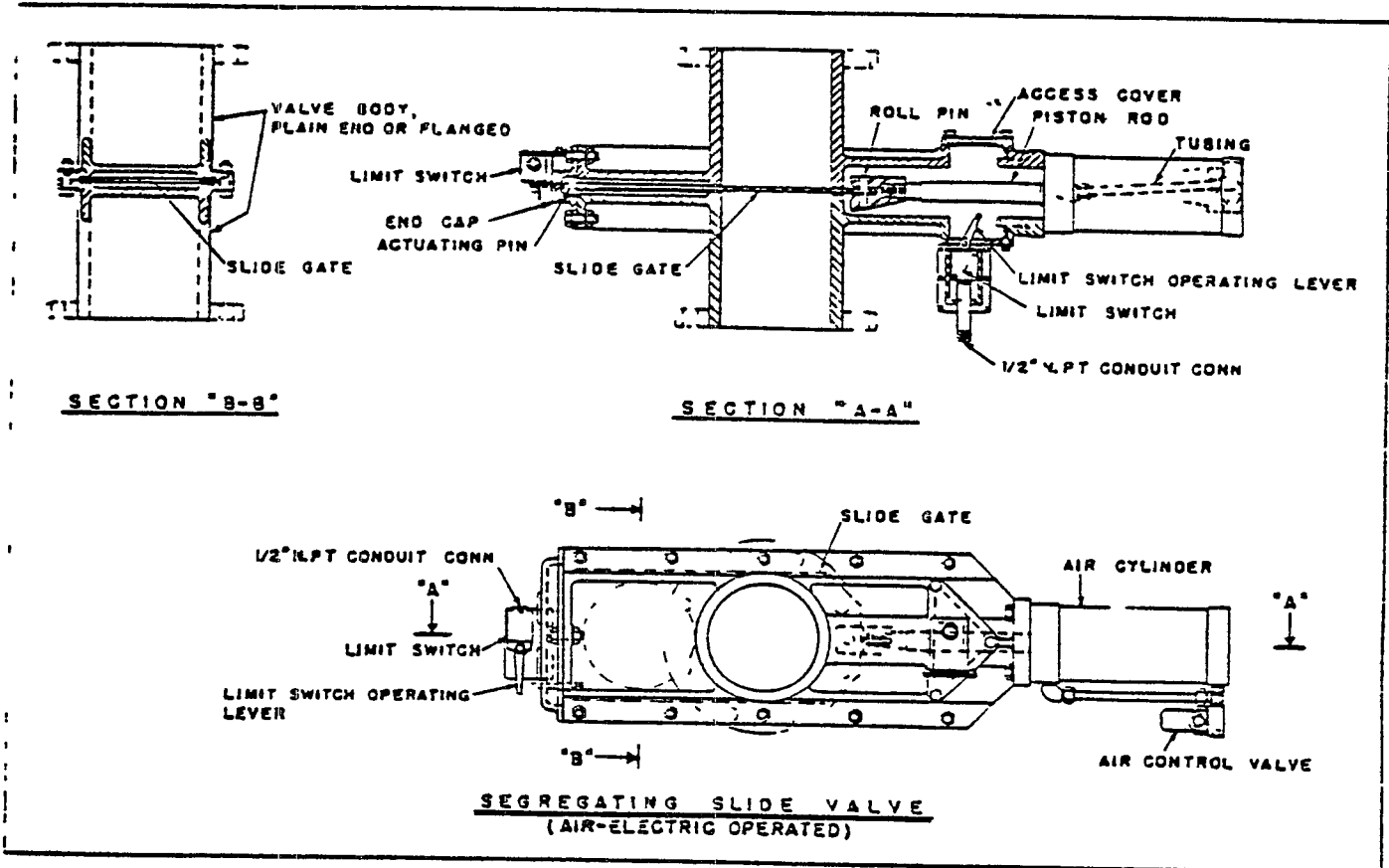
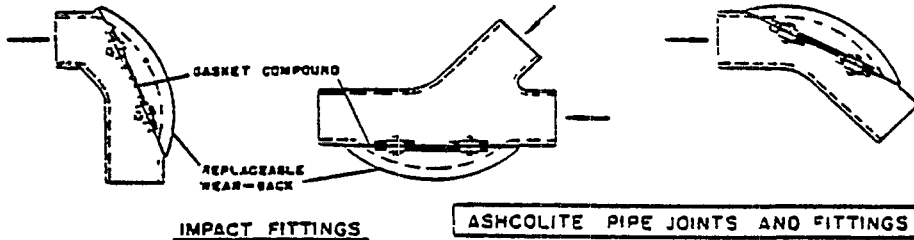
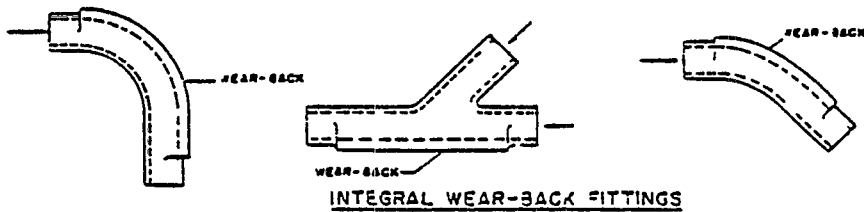
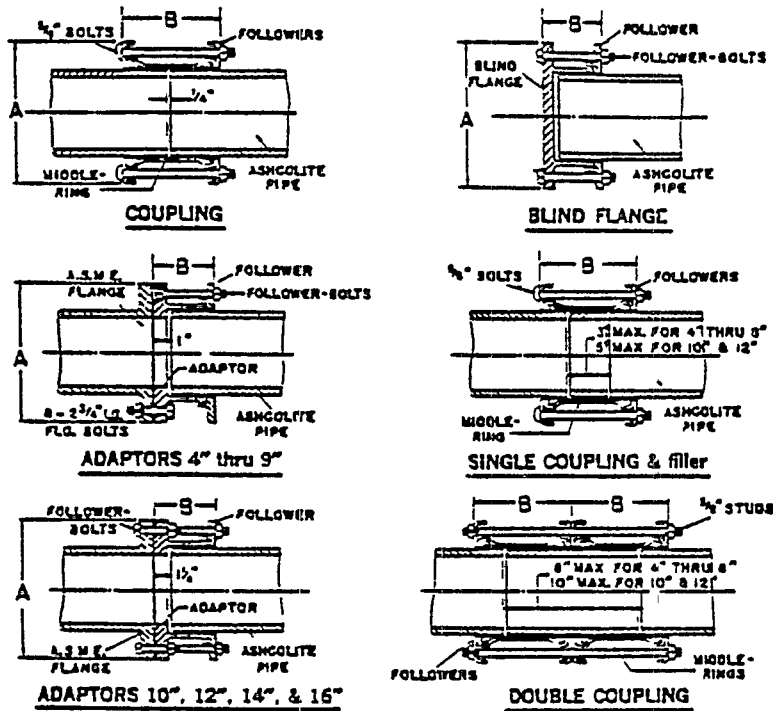

Figure VII-18

SEGREGATING VALVES

Reprinted from A Primer for Ash Handling by Allen-Sherman-Hoff Company, by permission of Allen-Sherman-Hoff Company, A Division of Ecolaire. Year of first publication 1976

STANDARD COUPLINGS, ADAPTORS & BLIND FLANGES



ASHCOLITE PIPE JOINTS AND FITTINGS

Figure VII-19

TYPICAL PIPES AND FITTINGS FOR ASH CONVEYING

Reprinted from A Primer for Ash Handling by Allen-Sherman-Hoff Company by permission of Allen-Sherman-Hoff Company, a Division of Ecolaire. Year of first publication. 1976.

wear backs is available for vacuum systems. These wear backs are reversible so that each provides two points of impact where abrasion is most severe. In addition, each wear back, for a given size pipe fitting, can be used on all fittings of that size. Some typical line sizes which may be used for varying system capacities are provided in table VII-13. Experience has shown that one line should handle no more than 50 TPH fly ash and that two lines with cross-over provision should be run to the silo (40).

Dust caught by the collectors is continuously dropped into a fly ash storage silo where it is held until disposed. Storage silos may be of carbon steel or hollow concrete stave construction. Flat bottom silos are equipped with aeration stones or slides to fluidize dust and induce flow to the discharge outlets. Motor driven blowers supply the fluidizing air. Silos are also provided with bag vent filters to prevent the discharge of dust along with displaced air as the silo is being filled. Alternately, venting can be provided by a duct from the silo roof back to the precipitator inlet. It may be necessary to supply low-pressure blowers on the vent duct to overcome losses which may prevent release of the conveying air, resulting in a pressure build up in the silo and drop-out of the fly ash in the duct.

Fly ash is normally deposited in trucks or railroad cars for transport to a dump area. In such cases, it is necessary to wet the dust to prevent it from blowing off conveyances during transportation. This is accomplished by means of conditioners which may be of the horizontal rotary pug-mill type or the vertical type.

The horizontal type is suitable for conditioning a maximum of 180 tons of dust per hour with water additions as high as 20 percent by weight (40). This unit requires a rotary feeding device between the discharge point and the unloader inlet to feed dry ash at a steady measured rate. Dust is fed by means of the star (rotary) feeder to the inlet of a screw feeder which carries the dust to the end of a rotating drum. Water is added at the discharge point of the screw feeder and at various points along the drum as the dust is tumbled and rolled past a series of scrapers toward the discharge point. Operator attention is essential to the satisfactory functioning of this conditioner.

The vertical conditioner is more adaptable to automatic operation with 20 percent water addition (40). This unit is supplied with a fluidizing feeder and metering cut off gate to provide uniform feed. Dust enters a chamber on the top of the vertical conditioner where it falls onto a rotating distributing cone. This creates a cylindrical curtain of dust which is sprayed from numerous directions by high-velocity fog-jet nozzles. The wetted dust, which is driven onto the walls of the bottom chamber, is moved toward the bottom discharge nozzle by means of a pair of motor-driven scraper blades.

Table VII-13

## ASH CONVEYING CAPACITIES OF VARIOUS SIZE PIPES (39)

<u>Pipe Size</u> (inside diameter in inches)	<u>Ash Generating Rate</u> (tons/hour)
6	15-20
8	25-50
10	50-75



Both units require water at a minimum pressure of 80 psi to achieve intimate mixing. Water supplied at a lower pressure cannot penetrate the mass of dust passing through in a very short period of time (40).

Controls for vacuum fly ash systems are activated by changes in vacuum. When a hopper is emptied of fly ash, the system vacuum will drop. A pressure switch then activates a rotary step switch to close the dust valve under the hopper and to open the valve under the next hopper. This procedure continues until all the hoppers are empty.

Maintenance. There are several high-maintenance areas associated with vacuum systems:

- o Vacuum Blowers - Problems may arise if the conveying air is insufficiently filtered upstream of the blower. Dust in the conveying air would then pass through the blower, and erode the blades.
- o Bag Filter - Bag filter breakage is a common maintenance problem, creating a fugitive dust problem usually just within the confines of the silo area.
- o Leakage - Leaks in the couplings of the pipe system can reduce the conveying power of the system. Maintenance problems for leakage are much less severe for vacuum systems as compared to pressure system leakage because all leaks are inward.
- o Vacuum Silo - Since the silo is generally outside the plant area, maintenance may be less frequent. For the vacuum silo, this can be more of a problem because it is more complex than a pressure silo due to the need for collectors.

Pressure Systems. This system conveys fly ash from individually controlled air locks (at the bottom of the ESP hoppers) to a dry storage silo by means of pressure provided by positive displacement blowers. A schematic diagram of a pressure system appears in figure VII-20. The mechanical blowers supply compressed air at pressures of up to 32 psi (40). The main difference between the vacuum and pressure systems is that the pressure system does not require cyclone collectors at the storage silo; instead, a vent filter relieves the silo of the air displaced by the incoming dust as well as the expanded volume of the conveying air. In some systems, a return line is run from the vent filter back to the ESP hopper to avoid possible fugitive dust emissions from the vent filter. A blower is usually required on this line to overcome draft losses.

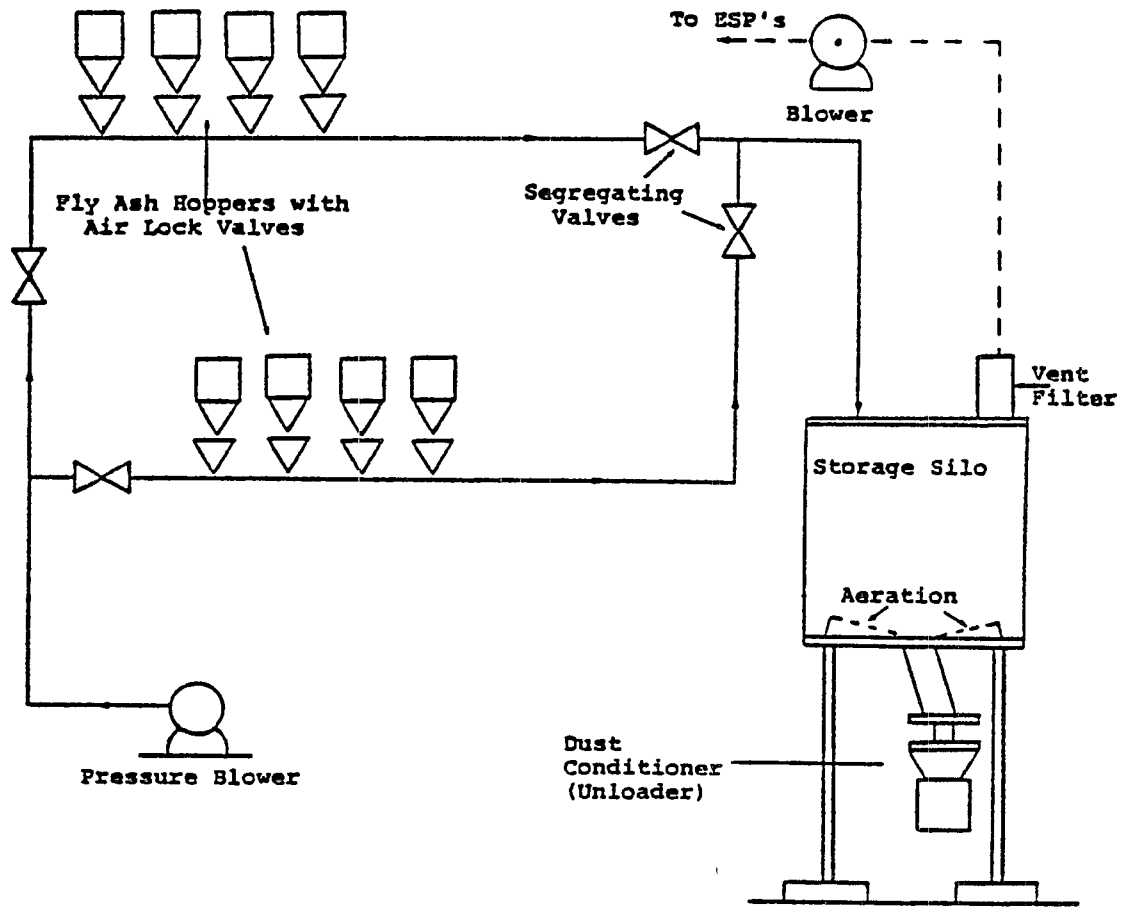

Figure VII-20  
 DRY FLY ASH HANDLING SYSTEM - PRESSURE SYSTEM

Equipment. The major components of a pressure system are essentially the same as those of a vacuum system with the following exceptions.

Air locks are used to transfer fly ash from a hopper at one pressure to a conveying line at a higher pressure (figure VII-21). These are available in a wide range of capacities to meet any handling rate required of a pressurized conveying system. Air-electric operated cylinders control the positioning of upper and lower feed gates in proper sequence with the equalizing valves between upper and lower chambers. Manual cut off gates are supplied at the inlet and discharge of each air lock to permit its removal without interrupting operation of the rest of the system (40).

Silo storage is the same as for vacuum systems except that dust collectors are not required; however, a self-cleaning vent bag filter is required. Air-to-cloth ratio should be no greater than 2.5 to 1; i.e., 2.5 cubic feet per minute to 1 square foot of bag cloth area (40). Vent ducts provide an alternate means of relieving air from silos.

Controls for pressure systems operate on a timed basis determined by the amount of dust stored in each row of collector hoppers. Individual air locks on any given row are carefully interlocked with the other air locks to prevent discharge of more than one hopper at a time. Programmable controls are available to permit changing of air lock cycling where dust loading fluctuations are expected.

Maintenance. There are several areas of high maintenance in a pressure system. The blowers, in general, are high-maintenance items. However, the risk of erosion of fan blades due to dust in the conveying air is not as great in the pressure system as it is in the vacuum system. Leakage, on the other hand, represents a more severe problem in the pressure system than it does in the vacuum system. Leaks in the pipe couplings can cause greater fugitive dust problems because of the positive pressure in the lines. In this sense, the pressure system is not as "clean" as the vacuum system.

Fugitive Dust Emissions. Dry fly ash handling systems potentially have significant dust emission problems. These dust emissions can occur at various locations within the ash handling system. Fly ash is a very abrasive material so problems generally arise in maintenance. Positive pressure fly ash transport systems generally incur problems in the pipe joints. One of the major maintenance problem areas with vacuum systems is with the bag filters used in the secondary or tertiary collectors on top of the storage silo. If these bags break, the dust-laden air stream will continue through the vacuum producer and into the atmosphere. If the vacuum producer is hydraulic, then the fly ash will be slurried with high-pressure water, eliminating the

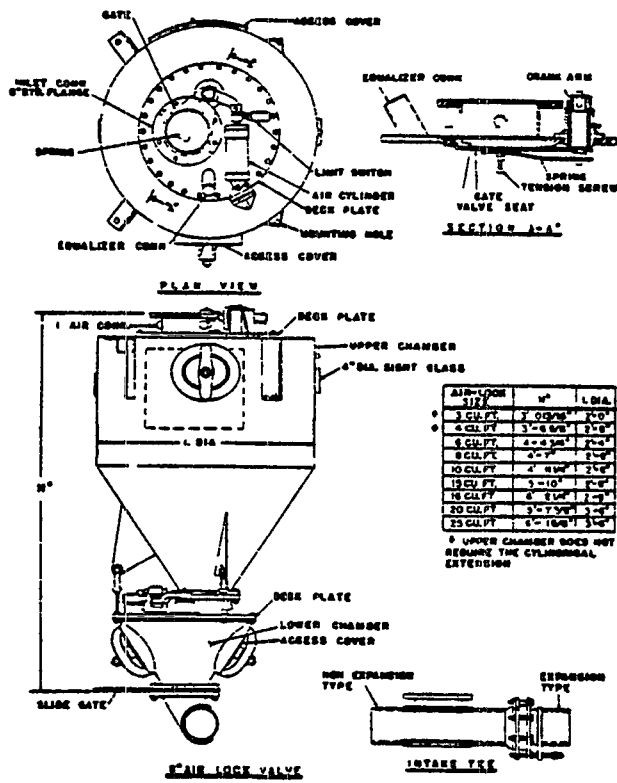

Figure VII-21  
 TYPICAL AIR LOCK VALVE FOR PRESSURE FLY ASH  
 CONVEYING SYSTEM

Reprinted from A Primer for Ash Handling by Allen-Sherman-Hoff Company by permission of Allen-Sherman-Hoff Company, a Division of Ecolaire. Year of first publication 1976.

dusting problem, dusting problems also arise from bag breakage if a mechanical exhauster is used. Another problem area is the unloader at the bottom of the silo where spray nozzles are used to wet the fly ash before it is dumped into the truck. These spray nozzles need continuous maintenance to avoid pluggage and subsequent dusting problems. Even with proper maintenance of the nozzles, the area around the unloader is still exposed to excessive dusting. Some facilities use roll-up doors to close off this area and vent the air back to the precipitator.

EPA conducted a telephone survey to determine the types of regulations on fugitive dust emissions which exist among different federal, state, and local authorities. In general, there are no regulations which apply specifically to dry fly ash handling systems. Fugitive dust emissions are usually covered by a more general regulation regarding particulate emissions such as a general opacity reading at the plant boundary. Regular monitoring or inspection for dust emissions is generally not required. Enforcement is based primarily on complaints.

Retrofitting. The motivation for retrofitting dry fly ash handling systems may stem from a variety of circumstances:

- o A shortage of water may exist for sluicing the fly ash to ponds,
- o State or local regulations for certain aqueous discharges may result in a retrofit, and
- o A marketable use for the fly ash such as an additive for making cement.

Very little, if any, equipment could be reused in retrofitting to a dry fly ash system from a wet handling system. The equipment needing removal would be:

- o Valves allowing flow from the ESP hopper into the sluice line, if the sluice line runs into the hopper;
- o Pumps for carrying fly ash to the pond; and
- o The line used for conveying the ash slurry.

In some cases, fly ash is pneumatically conveyed via a hydrovac-tor (or hydroveyor) to a mixing tank where it mixes with bottom ash for sluicing to a pond. The piping and vacuum producers, in these cases are potentially reusable. It would be necessary to shut down the existing equipment during installation of the new equipment.

Trip Reports. EPA visited several plants in order to define various bottom ash and fly ash handling practices. This subsection discusses dry fly ash handling systems encountered at some of these plants.

Plant 1811. This plant is a 615-MW coal-fired electric power generating station located in Northern Indiana. The ash is generated by two cyclone type boilers of 194 and 422 MW each. The coal is characterized as low sulfur with an ash content of 10 to 12 percent with 11 percent as the average. This bituminous coal comes from Bureau of Mines Coal Districts 10 and 11.

The fly ash handling system currently in use at the plant is a dry vacuum system that was retrofitted in early 1979. The previous system was a wet sluicing operation that used a hydroveyor and ponding. The major equipment for this dry system is presented schematically in figure VII-22. This is a dual system in terms of the separators, i.e., cyclones and bagfilters, and the mechanical exhausters. There are separate lines which run from Unit 8 ESP hoppers and Unit 7 ESP hoppers. These lines feed separate cyclone collectors and bagfilters, but one silo is used to store the ash transported by the two lines. The storage silo has a diameter of 35 feet. Sixteen hoppers feed the unit 8 line (10-inch diameter pipe) and eight feed Unit 7 line. The distance from the hoppers to the silo is approximately 300 feet. No major problems occurred in the changeover from hydroveying the ash to ponds to vacuum handling of the ash to a storage silo.

The fly ash system was fairly new at the time of the site visit, and no major operating difficulties had been encountered. Early experience showed that the optimum operating procedure was to run the mechanical exhausters continuously; intermittent operation had caused some difficulty in achieving a sufficient vacuum for fly ash transport. Minor erosion of the exhausters had occurred.

In 1978, the plant generated 38,100 tons of fly ash. This ash is currently trucked to a landfill site for disposal by an outside firm. Closed cement trucks are used; the ash is not conditioned at the silo.

Plant 1164. This plant is a 447-MW coal-fired powerplant located in Northwestern Colorado. The plant consists of two units: Unit 1 completed in 1965 and Unit 2 in 1976. The facility is a base-load plant which uses cooling towers for condenser heat dissipation, dry fly ash transport, and a zero discharge bottom ash sluicing system. The plant burns a bituminous coal from Bureau of Mines Coal District 17. The plant is sufficiently close to the coal mine (9 miles) to be considered a mine-mouth operation. Plant water is drawn from a nearby river. The facility uses a vapor compression distillation unit to recover recycleable water

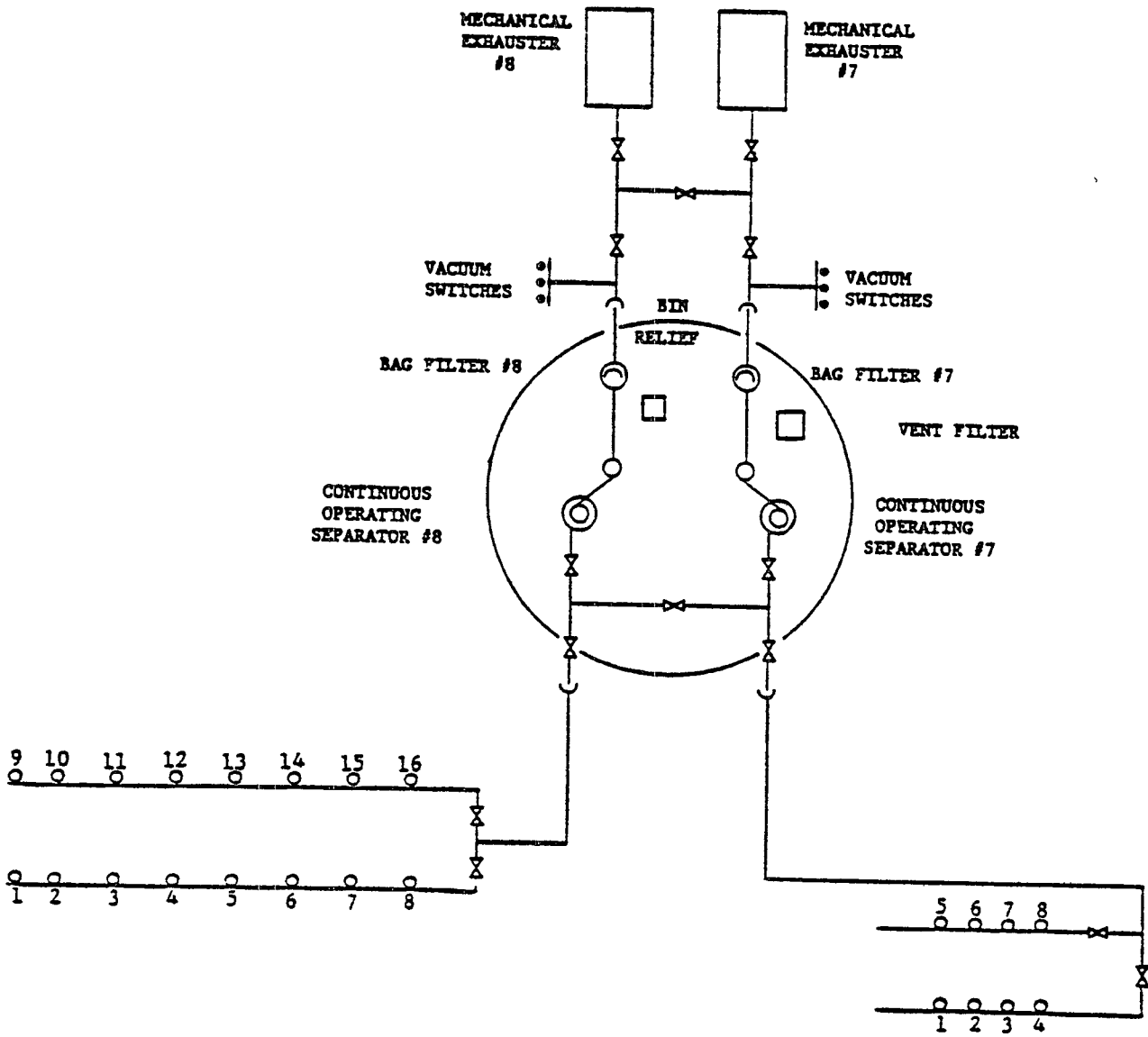

Figure VII-22  
 FLY ASH SILO AND HOPPERS/PLANT 1811

from cooling tower blowdown. All wastewaters are ultimately handled by an evaporation pond. A generalized flow scheme for the plant appears in figure VII-23. The water system, as currently in operation, was designed by Stearns-Rodgers.

The dry fly ash handling system for the plant removes fly ash from the boiler economizer hoppers and precipitator hoppers on Units 1 and 2 and transports the ash to a common fly ash silo where the ash is loaded into trucks. The trucks then transport the ash back to the mine site for burial. The system is pressurized and uses air as the conveying media. Ash conveying blowers supply the conveying air. Fly ash is fed into the system from the economizer and precipitator hoppers by "nuva" feeders in a programmed sequence and the air flow carries the ash to the plant fly ash silo. Exhaust air from the silo is vented by the fly ash silo vent fans to the Unit 2 precipitator flue gas inlet manifold.

Three positive displacement blowers are used to drive the fly ash from the ESP and economizer hoppers to the plant storage silo. These blowers include one spare. Blower 1 serves Unit 1; blower 3 serves Unit 2; and blower 2 is the spare. These blowers each have a capacity of 2,900 ACFM at 13.5 psig and are driven by 250 hp, 480-volt, 3-phase, 60-hertz, 1,800-rpm electric motors. A 10-inch line is run from the Unit 2 blower to the Unit 2 precipitator and economizer hoppers. Each of the two precipitators contain 16 ash hoppers and the economizer contains four hoppers. The conveying air is piped to service nine groups of hoppers, each group containing four hoppers. Fly ash from each group of four hoppers is automatically fed by "nuva" feeders in a programmed sequence contained in the fly ash control system which empties the hoppers in each group one at a time.

The fly ash system for Unit 1 consists of one four-branched conveyor, which automatically conveys fly ash from 24 precipitator "nuva" feeders. The "nuva" feeders are essentially airlocks which utilize fluidizing stones to achieve better dust flow characteristics from the hopper to the pressure pneumatic conveyor. "Nuva" is a trade name used by United Conveyor for their airlocks. The air displaced by ash in the precipitator feeders is vented through a bag filter to the atmosphere. Air displaced by the economizer ash is vented back into the hopper.

From the hoppers the fly ash and conveying air travel through a 10-inch line into the plant fly ash silo. The conveying air is vented from the silo through a 16-inch line by three fly ash silo vent fans. The air is piped through one of two 14-inch lines leading to the Unit 1 and 2 precipitators. The three silo vent fans are driven by 50-hp, 480-volt, 3-phase, 60-hertz, 1,800-rpm electric motors.



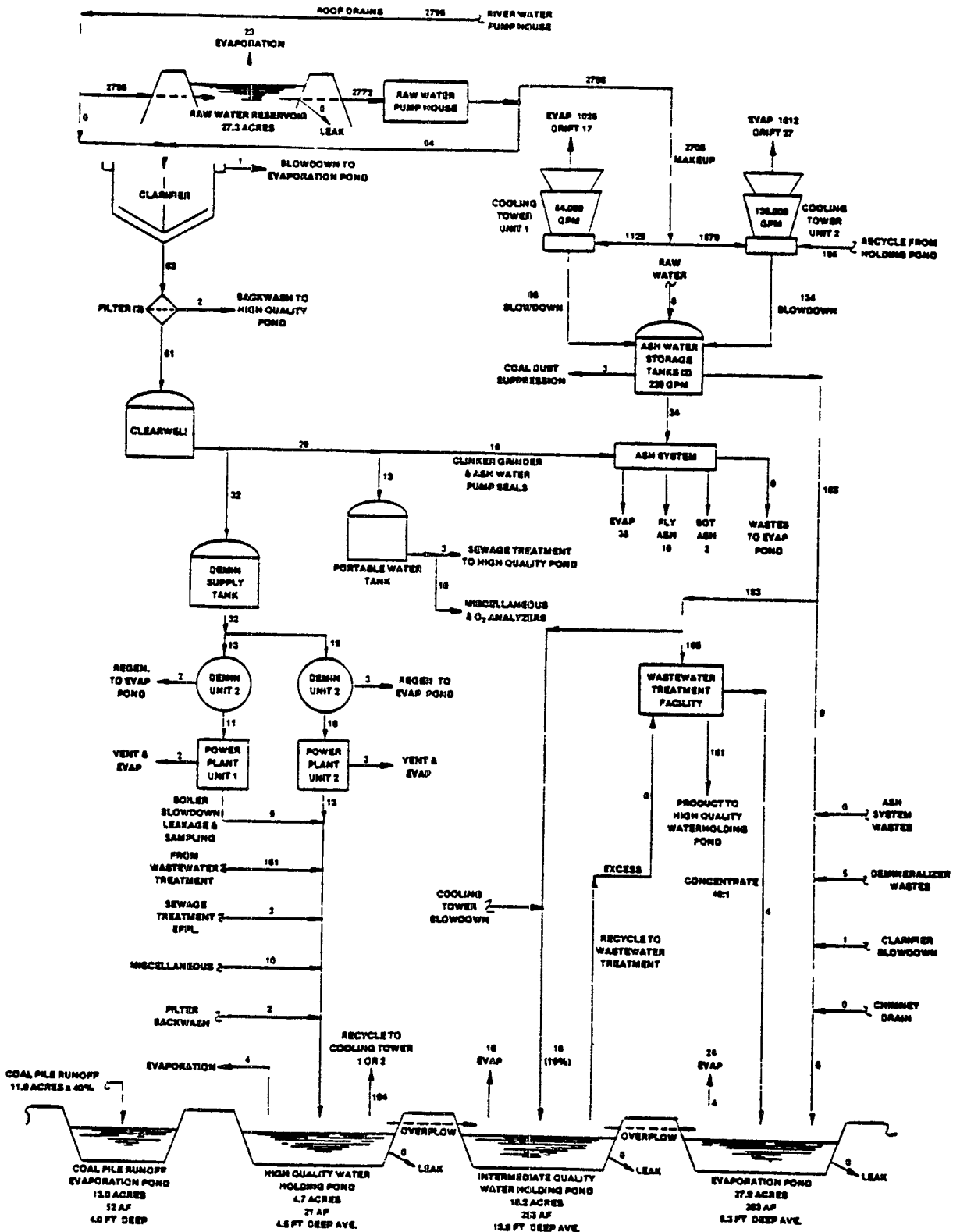

**CONDITIONS.**  
 ALL FLOWS IN AVERAGE GPM  
 70% CAPACITY FACTOR  
 AVERAGE ANNUAL COOLING TOWER EVAPORATION  
 COOLING TOWER CONCENTRATION 11 CYCLES  
 COOLING TOWER DRIFT 0.02% OF CIRC. WATER FLOW  
 RESERVOIR & POND NET ANNUAL AVERAGE  
 EVAPORATION 0.26 GPM/ACRES (16.7 IN/YR)

Figure VII-23  
 FLOW DIAGRAM FOR PLANT 0822

The rotary unloaders condition the fly ash which is then hauled to the mine for disposal. Ash water from the bottom ash surge tank is pumped to the fly ash silo by two fly ash unloader pumps through a 6-inch line.

The most significant maintenance item is the blowers. These have required two mechanics full time due to the erosion of the compressors. Other problems occur with pipe fitting leakage due to pipe expansion. The pipe expands because of the high temperature (700°F) fly ash which is being conveyed.

This system was installed along with the bottom ash system in 1974 as a retrofit to Unit 1 and as new to Unit 2. No particular problems were encountered in this retrofit. Some downtime was required to hookup the fly ash conveying pipe and airlocks to the ESP and economizer hoppers. Also, the old wet sluicing pipe needed to be taken out. No pipe was reusable for the fly ash system.

Plant 3203. This plant is a 340-MW western bituminous coal-burning facility which fires a moderately low-sulfur coal (average 0.6 percent) with an average ash content of 12 percent. The availability of the three boilers has historically averaged 86 percent annually.

The dry fly ash handling system currently in use is a pressure system designed and installed by United Conveyor Corporation. Fly ash is generated by three pulverized dry bottom coal-fired units. Operating conditions at the plant indicate that 80 percent of the coal ash leaves the boilers via the flue gas stream. This corresponds to approximately 385 TPD of fly ash being generated. Approximately 0.3 percent of this fly ash is collected in the economizer hopper; the ash collected there is sluiced to the bottom ash handling system at a rate of 1 TPD. The majority of the remainder of the fly ash is collected in mechanical collecting devices, cyclones, with an efficiency of 75 percent. The remaining 25 percent is collected in the air pre-heater and stack hoppers. The fly ash collected is then conveyed under pressure to a storage silo for commercial use or disposal. Approximately 250 TPD of the fly ash is sold dry, or unconditioned, to a cement company as an additive for \$1 per ton. The remainder is conditioned and trucked to an on site landfill.

The pressure system is diagrammed in figure VII-24. There are six hoppers per mechanical collector which feed through an airlock device into a pressurized (8-10 psig) pneumatic conveying line which leads to the storage silo. The distance from the cyclone hoppers to the storage silo is approximately 500 feet. The volume of the silo is 30,000 cubic feet and the pneumatic lines leading to the silo are 6 to 7 inches in diameter. This

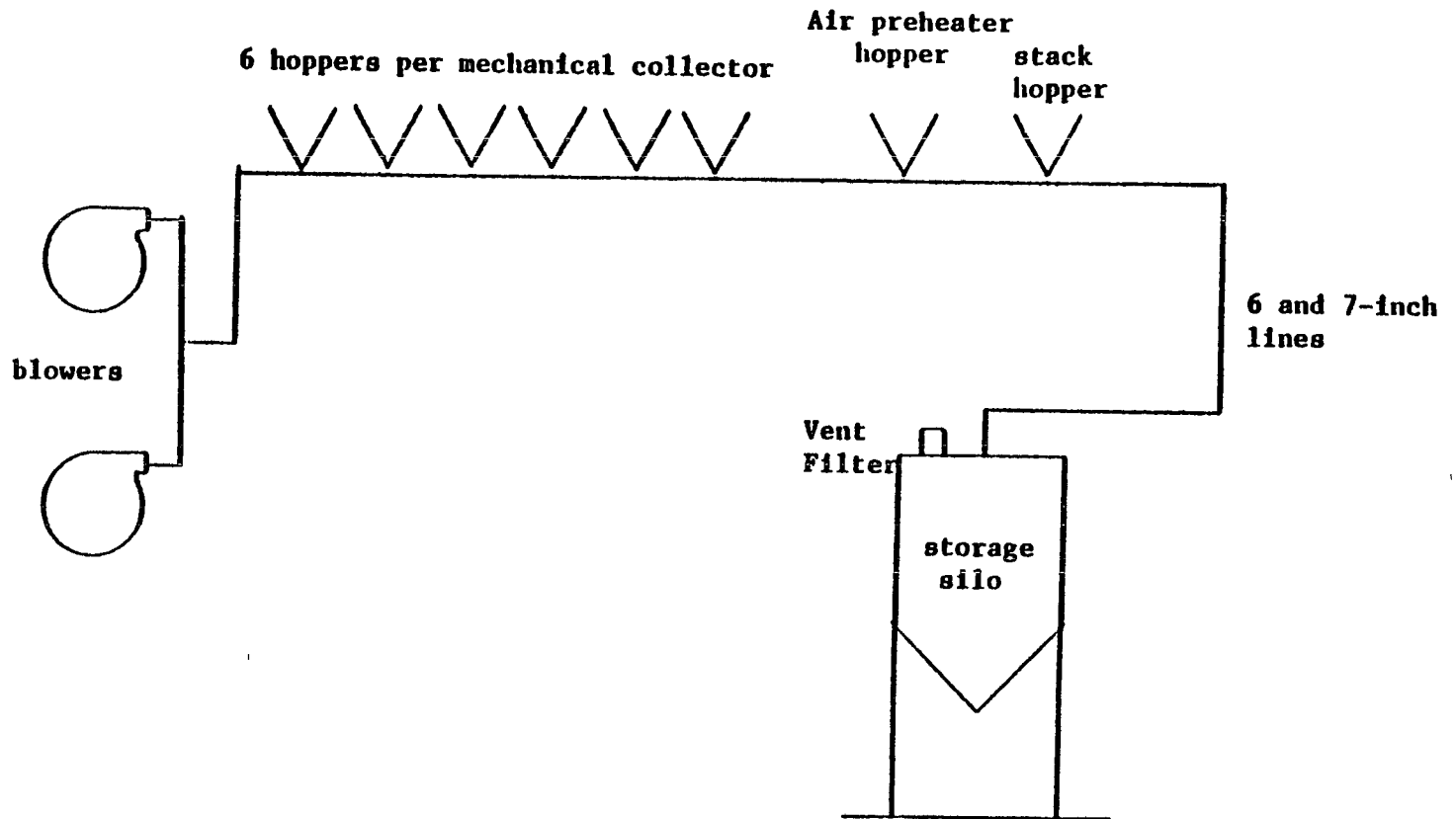

Figure VII-24  
PRESSURE FLY ASH HANDLING SYSTEM FOR PLANT 3203

silo volume provides approximately a 2-day storage capacity and therefore requires dumping several times a week.

The equipment which required the most maintenance during the past 4 years of operation of the unit were (1) the blowers and (2) valves and elbows. There were no real problems with the rest of the system.

The motivation for retrofitting this system was twofold: a general water shortage problem existed and approximately 250 TPD of the fly ash was a saleable product at a rate of \$1 per ton. At the time the pressure dry fly ash system was installed in 1975, a dewatering bin system and a third unit boiler were also installed. A 2-week outage for Units 1 and 2 was incurred when these retrofit systems were installed.

Utilization of the Systems. Data from the 308 survey were used to evaluate the distribution of fly ash handling systems for the following parameters:

- o fuel type,
- o boiler type,
- o location,
- o size, and
- o intake water quality.

**Fuel Type.** The most important fuel type is coal. This fuel type accounts for 74 percent of the fly ash handling systems as shown in figure VII-25. Dry fly ash handling systems are as common as wet once-through systems for coal-burning facilities and represent 34 percent of all ash handling systems. Wet recirculating systems, however, are much less common, representing only 2 percent of all ash handling systems. This distribution does not change significantly among coal, gas, and oil-burning facilities. Thus, it seems that fuel type has little effect on the type of ash handling system used.

The distribution of ash handling systems among different coal types is shown in figure VII-26. Coal type does not seem to significantly affect the distribution of systems. Bituminous coal facilities, by far the most common of the three coal types considered, are split between dry and wet once-through systems. Wet recirculating systems are rare.

**Boiler Type.** Three major boiler types are considered in this analysis: cyclone, pulverized coal, and spreader stoker units.

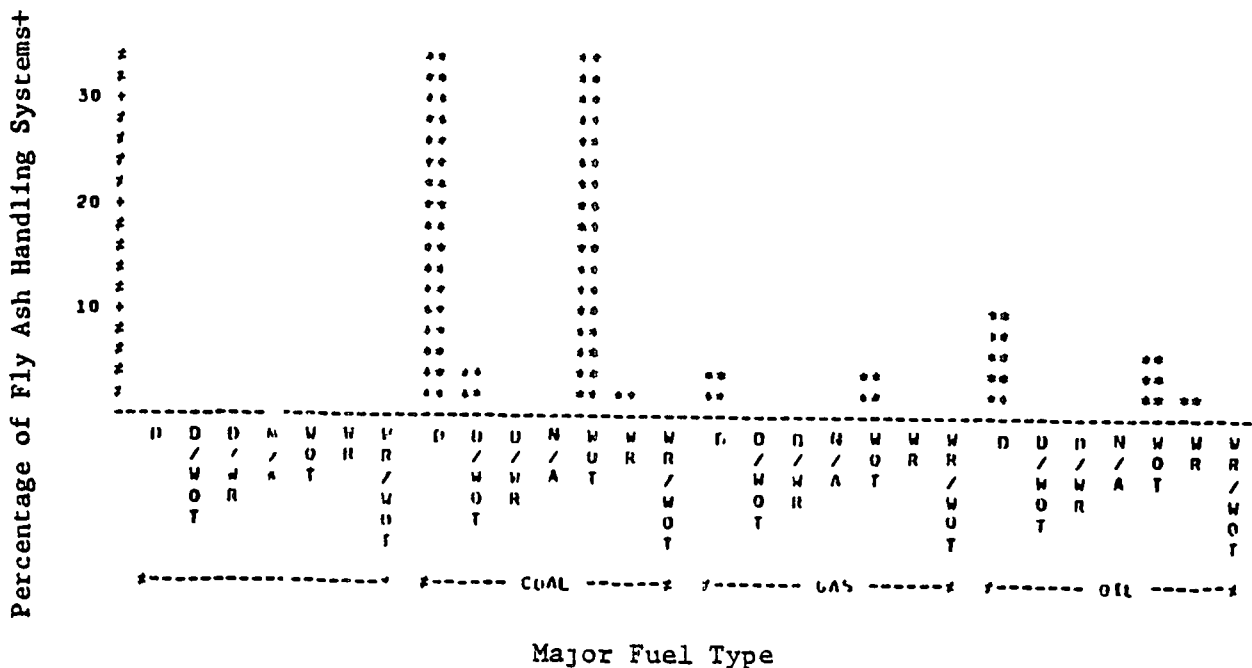

Key D Dry Fly Ash Handling System  
WOT Wet Once-Through Fly Ash Handling System  
WR Wet Recirculating Fly Ash Handling System

NOTE Plants which could not be identified under a subgroup appear in a subgroup on the far left of the chart, designated by a " " or by "----"

Figure VII-25  
DISTRIBUTION OF FLY ASH HANDLING SYSTEMS  
BY MAJOR FUEL TYPES

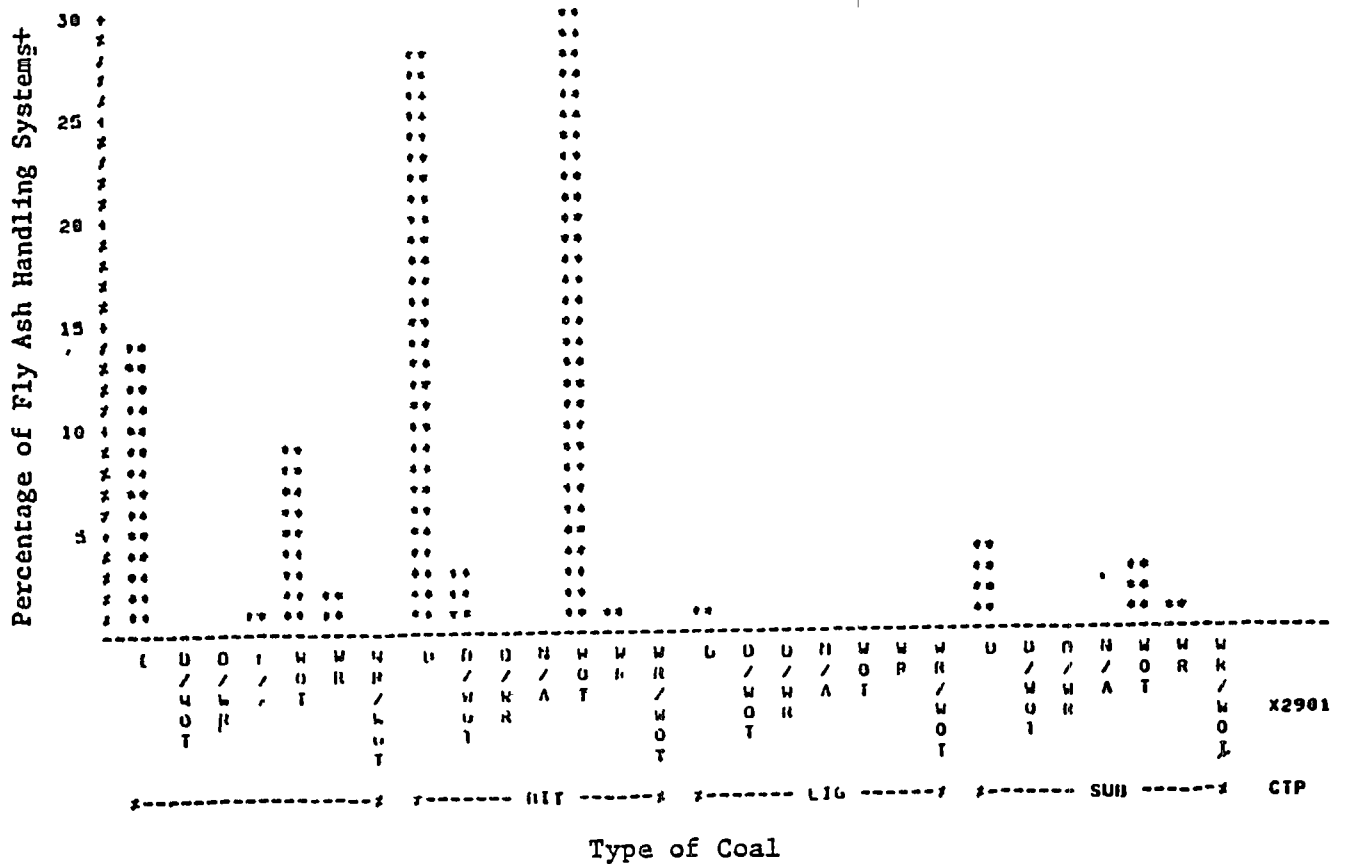

Key- D: Dry Fly Ash Handling System  
 WOT Wet Once-Through Fly Ash Handling System  
 WR Wet Recirculating Fly Ash Handling System

NOTE: Plants which could not be identified under a subgroup appear in a subgroup on the far left of the chart, designated by a " " or by "---"

Figure VII-26  
 DISTRIBUTION OF FLY ASH HANDLING SYSTEMS BY COAL TYPE

Figure VII-27 indicates that the type of boiler does influence the distribution of fly ash handling systems. Dry fly ash units are outnumbered three-to-one by wet once-through systems for cyclone units. Eighty to 90 percent of the ash produced by a cyclone boiler is bottom ash. Since the cyclone boiler is a slagging boiler, the bottom ash is usually handled wet; thus, it is not surprising that the remaining 10 to 20 percent of the ash is more frequently handled wet. Wet recirculating systems are rare (less than 2 percent of the systems reported) for cyclone boilers, as well as for pulverized and stoker boilers. Pulverized coal units seem to have the same distribution of fly ash handling systems as discussed previously for fuel types. Dry systems are very common (almost equal in number to wet once-through systems), and wet recirculating systems are rare. Spreader stoker units use a much larger proportion of dry systems than wet once-through systems. Wet recirculating systems are rare.

**Location.** The distribution of fly ash handling systems for each of the 10 EPA regions is shown in figure VII-28. A map displaying the EPA regions is provided in figure VII-29. The distribution indicates that there are some regional variances in the distribution of fly ash handling systems.

Regions I through III show a slightly greater frequency of dry systems (as opposed to wet once-through) and very few instances of wet recirculating systems. Oil-burning facilities are more common in the Northeast. The low ash production rate of oil-burning facilities may be one explanation for the increased use of dry fly ash systems. In addition, insufficient land for ponding may also contribute to the choice of dry over wet handling.

In Region IV, wet once-through systems are most commonly used. Dry fly ash systems represent 3 percent of all ash handling systems. Wet once-through systems account for 18 percent of all ash handling systems. The high occurrence of wet once-through systems may be due in part to the greater availability of land for ponding rather than some restriction on the use of dry systems.

In Regions V, VI, and VII, dry systems are competitive with wet once-through systems.

In Regions VIII and IX, the proportions of dry and wet recirculating systems are considerably higher than those of any other region. This reflects the need to conserve water in these areas. The only systems reported in Region X are dry fly ash systems. Again, this is a result of the scarcity of water in the West.

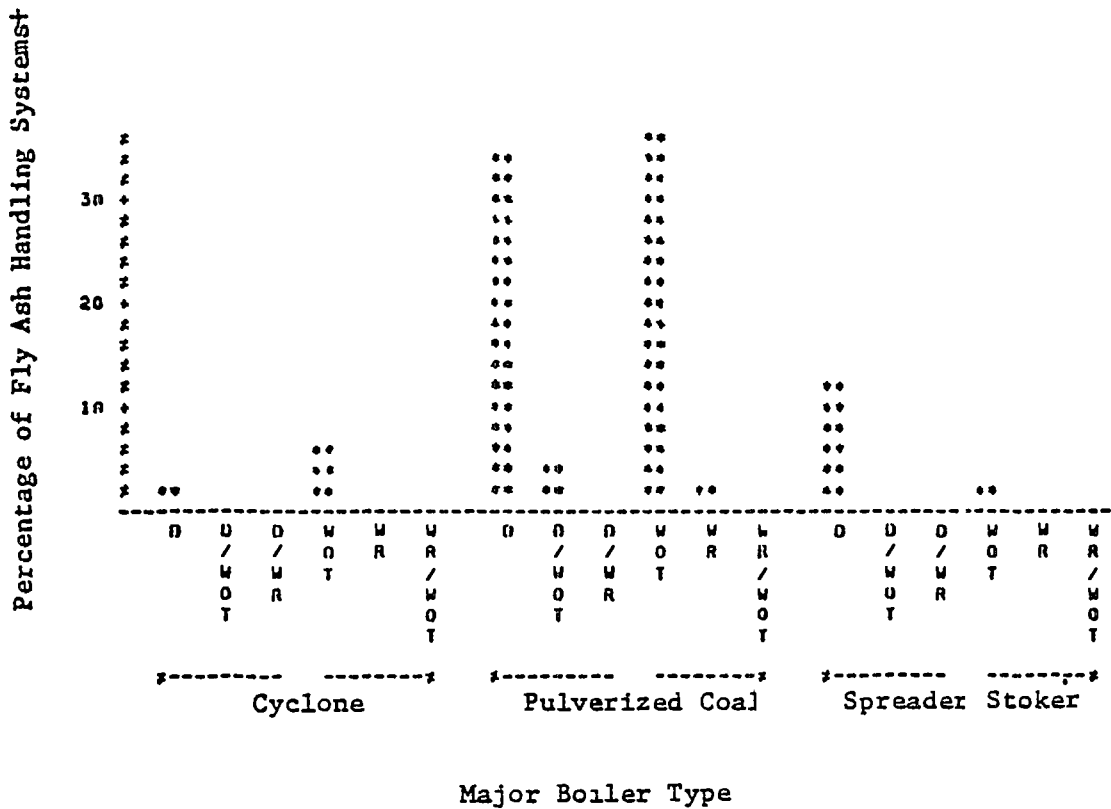

- Key D. Dry Fly Ash Handling System  
WOT Wet Once-Through Fly Ash Handling System  
WR Wet Recirculating Fly Ash Handling System

NOTE. Plants which could not be identified under a subgroup appear in a subgroup on the far left of the chart, designated by a " " or by "---".

Figure VII-27  
DISTRIBUTION OF FLY ASH HANDLING SYSTEMS  
BY MAJOR BOILER TYPES



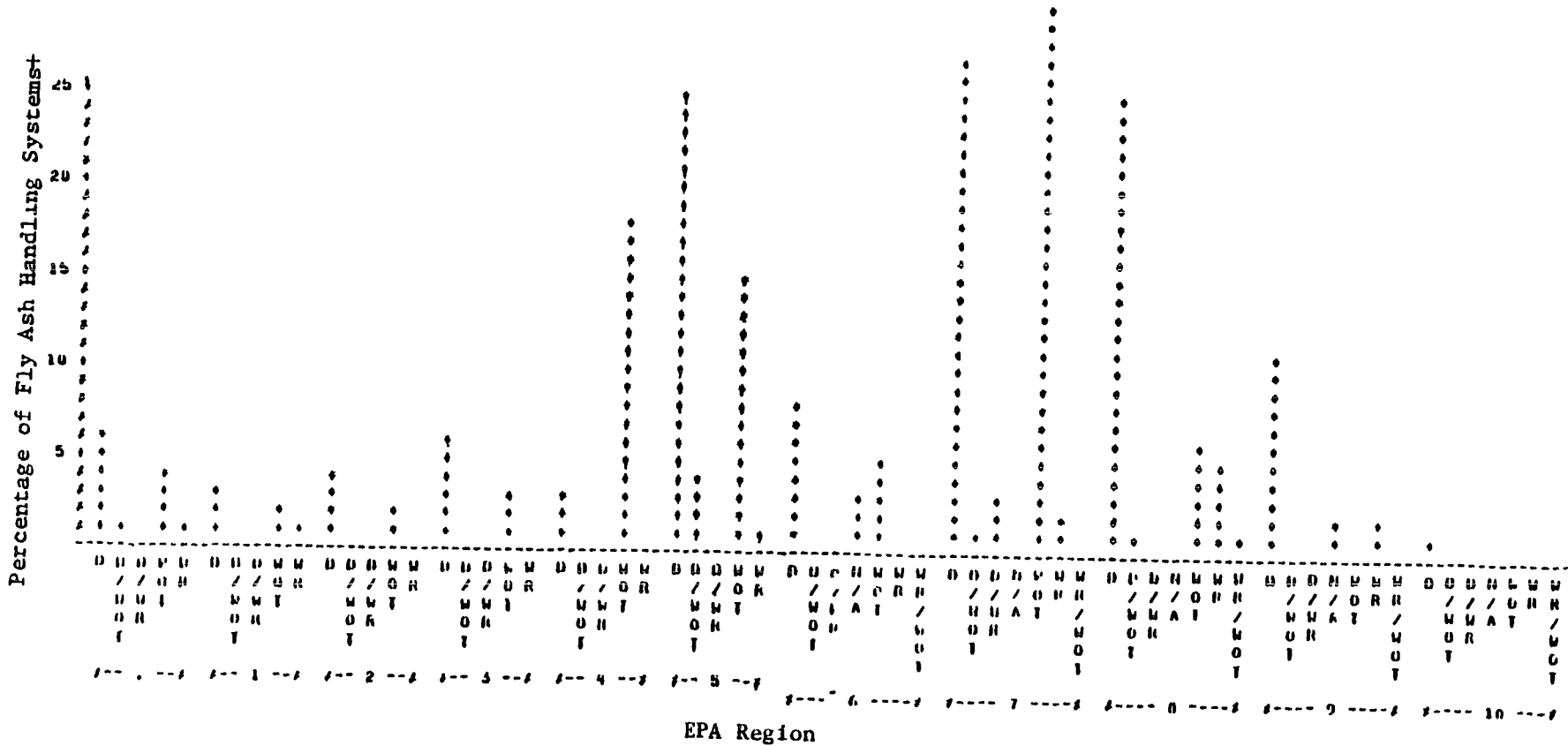

Key D Dry Fly Ash Handling System  
WOT Wet Once-Through Fly Ash Handling System  
WR Wet Recirculating Fly Ash Handling System

NOTE Plants which could not be identified under a subgroup appear in a subgroup on the far left of the chart, designated by a " " or by "----"

Figure VII-28  
DISTRIBUTION OF FLY ASH HANDLING SYSTEMS BY EPA REGION

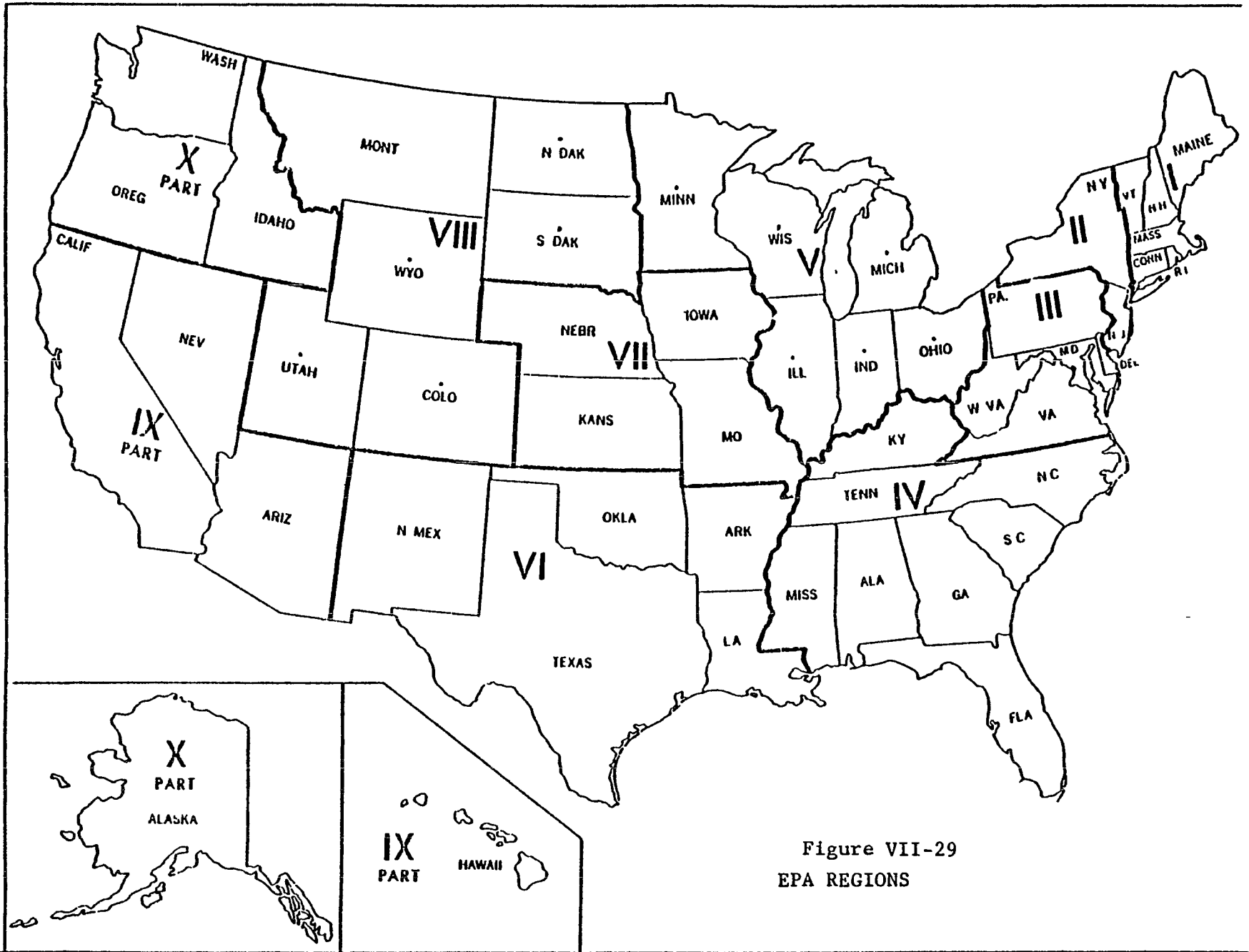

Figure VII-29  
EPA REGIONS

Plant Size. Plant size is expressed in plant nameplate capacity. The distribution of fly ash handling systems by various plant size categories is presented in figure VII-30. Category 1 is dominated by dry fly ash systems. This probably reflects the dominance of stoker boilers among low capacity plants. As plant capacity increases above 100 MW, wet once-through systems become competitive with dry fly ash systems. For plants greater than 500 MW, the percentage of wet once-through is slightly greater than the percentage of dry systems.

Intake Water Quality. Intake water quality was measured as total dissolved solids (TDS). The distribution of fly ash handling systems by intake water quality is presented in figure VII-31. No significant differences in the distribution of fly ash systems are apparent among any of these categories.

Retrofitted Dry Fly Ash Systems. Table VII-14 presents a list of plants which have been identified as having retrofitted dry fly ash systems.

Partial Recirculating Systems. The wet handling of fly ash is achieved by sluicing the fly ash from the collection device, ESP or cyclone hopper, to a pond. Settling of the fly ash typically occurs in primary and secondary ponds. A third settling area, usually referred to as a clear pond, is used if the sluice water is to be recycled. Total recirculation of the ash pond transport water is a zero discharge system. If less than total recycle occurs, the system is defined as a partial recirculating system.

#### Partial Recirculating Systems

Process Description. A generalized schematic of a typical partial recirculating system is shown in figure VII-32. Sluiced ash is pumped to the primary and secondary pond and flows to the clear pond from which water is recirculated by the main recirculation pumps to the main sluice pumps to be used as dilution water. A portion of the clear pond overflow is discharged.

There are various methods of sluicing the fly ash from the collection point. A typical method is illustrated in figure VII-33. Fly ash from the ESP hoppers is vacuum conveyed through the vacuum producer where it is slurried with the high-pressure water used to create the vacuum for conveying. This slurry is discharged through an air separator. From the air separator, the sluiced fly ash may flow by gravity to the pond or to a mix tank before it is pumped to the pond site. Slurry pumps are necessary when the ash slurry is pumped a great distance to the pond, which is often the case. Many ponds are typically 1,000 to 3,000 feet from the hoppers.

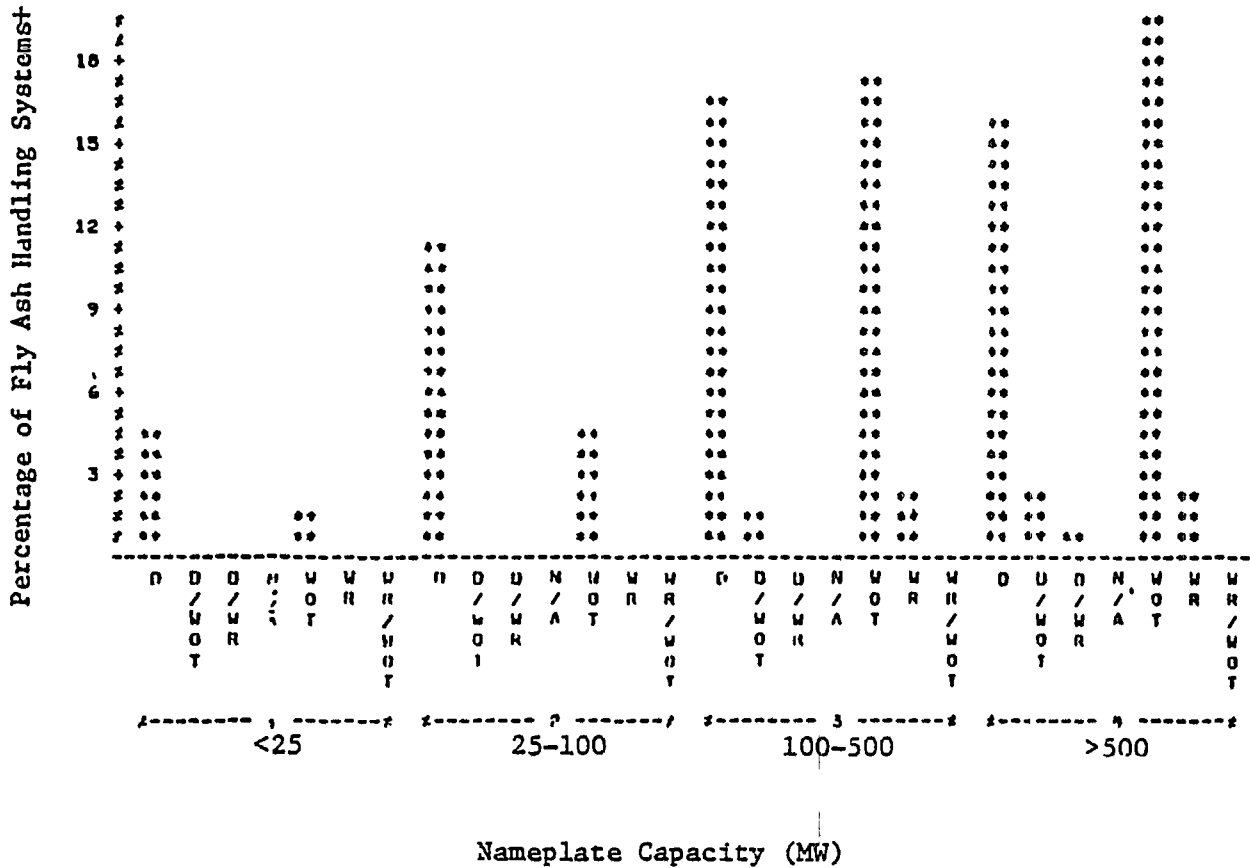

Key D. Dry Fly Ash Handling System  
 WOT. Wet Once-Through Fly Ash Handling System  
 WR. Wet Recirculating Fly Ash Handling System

NOTE. Plants which could not be identified under a subgroup appear in a subgroup on the far left of the chart, designated by a " " or by "---"

Figure VII-30  
 DISTRIBUTION OF FLY ASH HANDLING SYSTEMS  
 BY VARIOUS PLANT SIZES

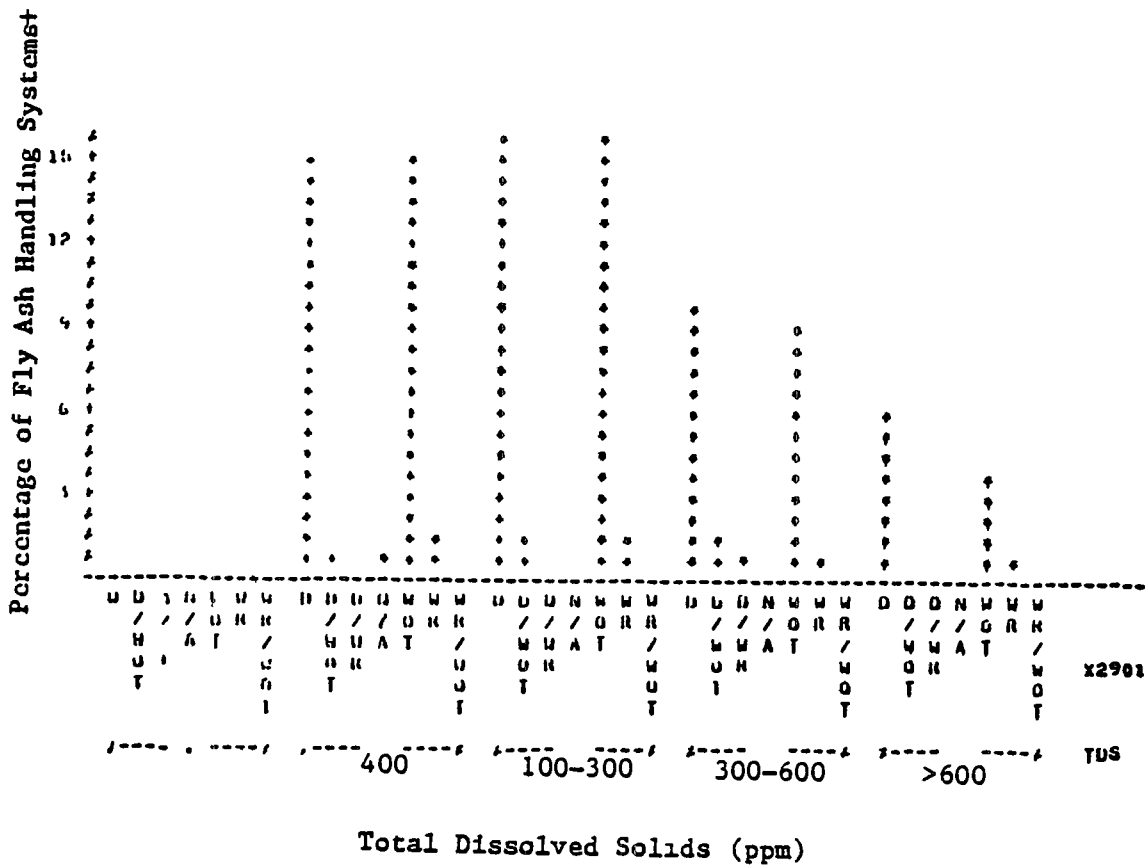

Key D Dry Fly Ash Handling System  
WOT Wet Once-Through Fly Ash Handling System  
WR Wet Recirculating Fly Ash Handling System

NOTE Plants which could not be identified under a subgroup appear in a subgroup on the far left of the chart, designated by a " " or by "---"

Figure VII-31  
DISTRIBUTION OF FLY ASH HANDLING SYSTEMS  
AS A FUNCTION OF INTAKE WATER QUALITY

Table 1-14

## PLANTS WITH RETROFITTED DRY FLY ASH HANDLING SYSTEMS

<u>Plant/Utility</u>	<u>Location (EPA Region)</u>	<u>Capacity (MW)</u>
Gallatin/TVA	Summer, TN (IV)	1255.2
John E. Amos/ Appalachian Power Co.	Kanawha, WV (III)	2932.6
Kirk/Black Hills Power & Light Co.	Lead, SD (VIII)	31.5
Ben French/Black Hills Power & Light Co.	Rapid City, SD (VIII)	22.0
Fisk/Commonwealth Edison Co.	Cook, IL (V)	547.0
Bailey/No. Indiana Public Service Co.	Porter, IN (V)	615.6
Ashtabula/Cleveland Electric Illuminating Co.	Ashtabula, OH (V)	640.0
Avon Lake/Cleveland Electric Illuminating Co.	Lorain, OH (V)	1,275.0
Eastlake/Cleveland Electric Illuminating Co.	Lake, OH (V)	1,257.0
Lake Shore/Cleveland Electric Illuminating Co.	Cuyahoga, OH (V)	514.0
Coffeen/Central Illinois Public Service	Montgomery, IL (V)	1,005.5
Reid Gardner/Nevada Power Co.	Moapa Clark Co., NV (IX)	340.8
Hayden/Colorado-Ute	Hayden, CO (VIII)	447.0
Cherokee #3/Public Service of Colorado	Adams, CO (VIII)	801.3
Bowen/Georgia Power Company	Bartow, GA (IV)	2,547.0
Arkwright/Georgia Power Co.	Bibb, GA (IV)	181.0
McDonough/Georgia Power Company	Cobb, GA (IV)	598.0
Port Wentworth/ Savannah Electric & Light	Chatham, GA (IV)	333.9

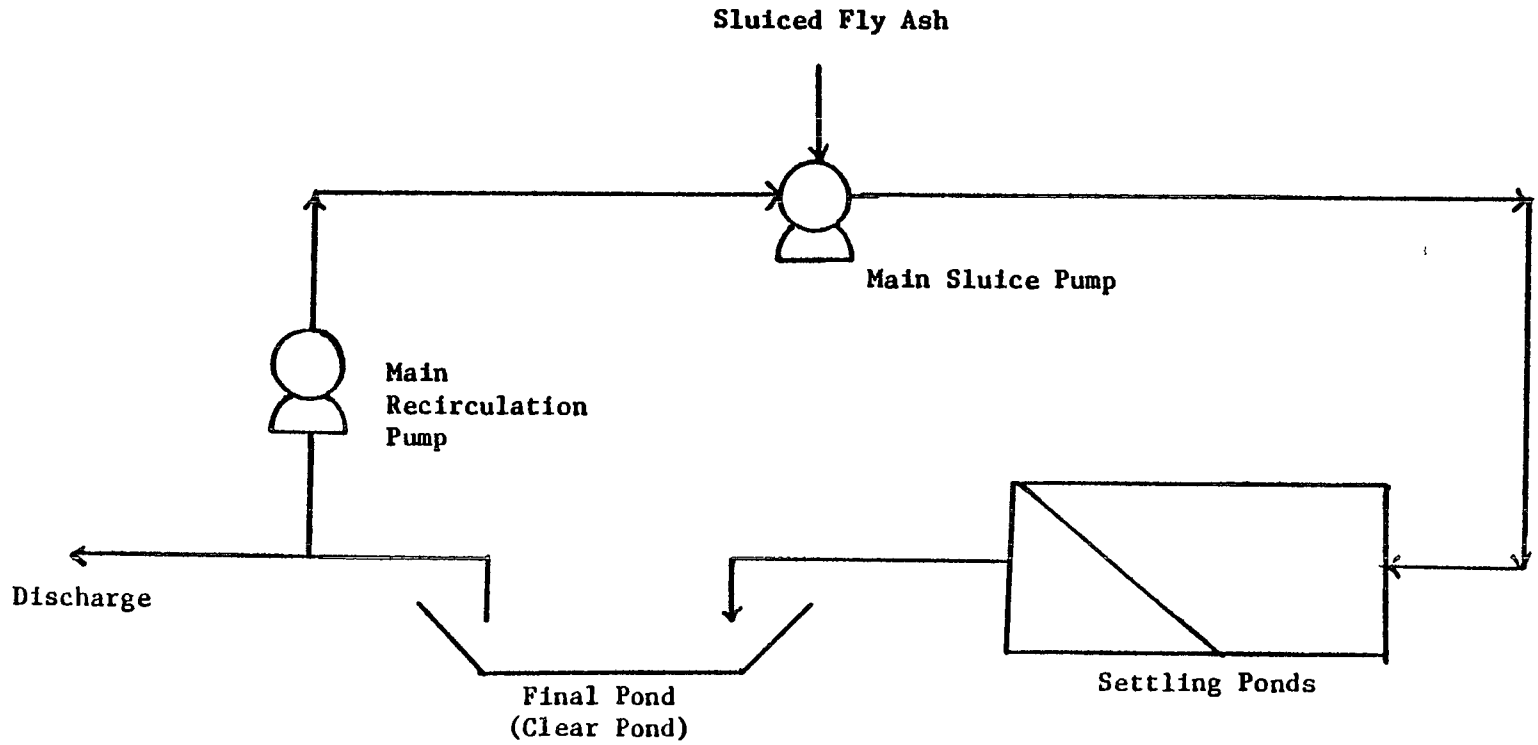

Figure VII-32  
GENERALIZED, SCHEMATIC DIAGRAM OF A PARTIAL RECIRCULATION FLY ASH  
HANDLING SYSTEM

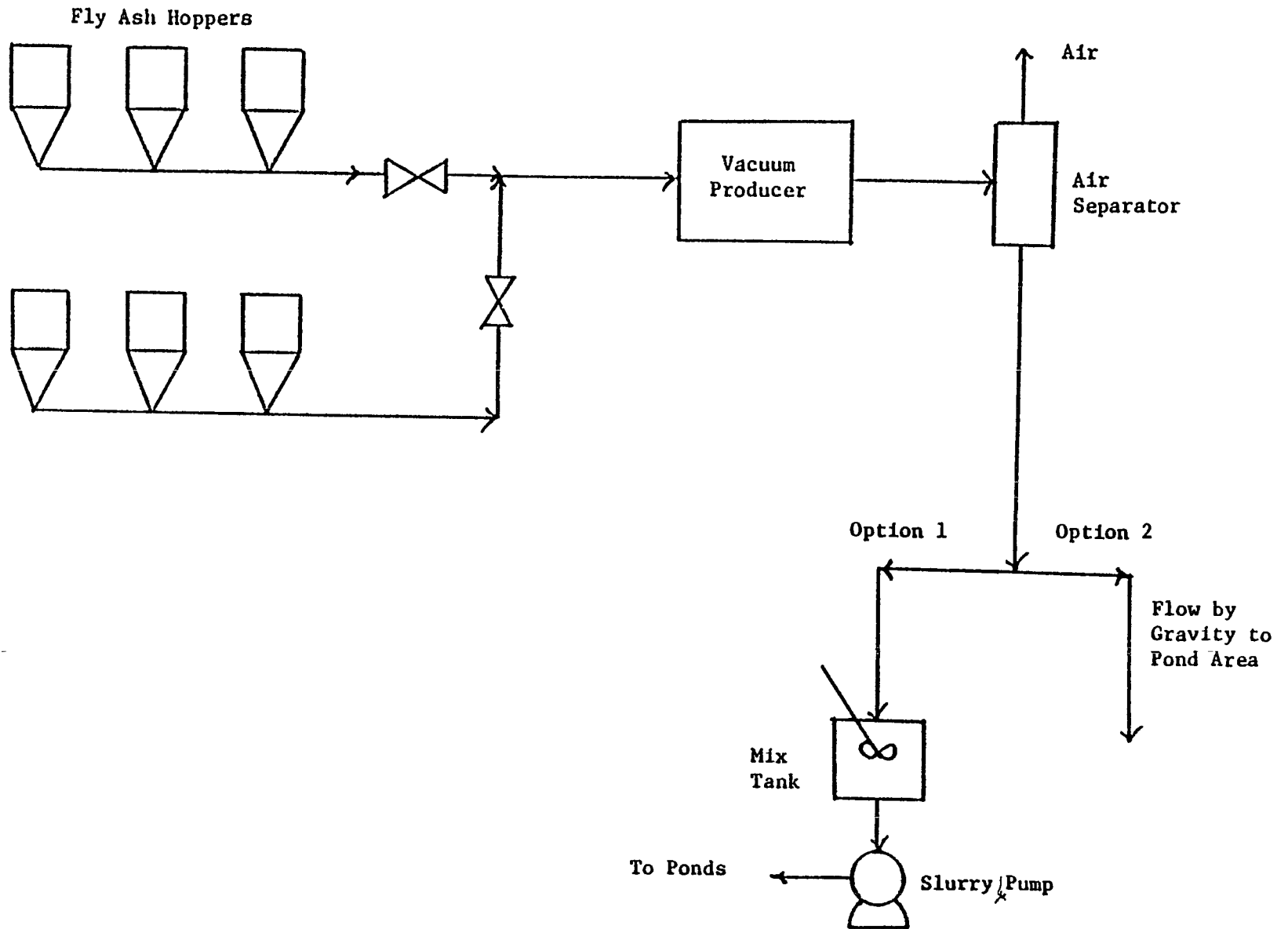

Figure VII-33  
A TYPICAL METHOD OF SLICING FLY ASH FROM COLLECTION POINTS



Equipment. The equipment associated with dry conveying, i.e., all equipment up to and including the vacuum producer, is discussed in the sections on dry fly ash handling. The major equipment discussed in this section includes:

- o air separator,
- o pumps,
- o conveying pipe, and
- o ponds.

Air Separator. A typical air separator is shown in figure VII-34. A wide variety of separators, unlined or with basalt linings, is available for single and multiple systems.

Pumps. Slurry pumps may be centrifugal pumps or ejectors (jet pumps). Either pump requires considerable dilution at the suction in order to provide a slurry that can be pumped. For the same discharge quantity and discharge head, a centrifugal pump is about 40 percent more efficient than a jet pump without considering the efficiency of auxiliary pumping equipment which supplies the ejector nozzle (40). Jet pumps are generally more favorable for slurry handling than centrifugal pumps because of the relative ease with which they can be serviced, even though such service may be required much more frequently than for a comparable centrifugal pump. The higher maintenance requirement is due to higher operating pressure in the ejector nozzles.

Hard metals are employed in the construction of both types of pumps in areas where abrasion is most severe. It is desirable to maintain velocities as low as possible within the limits of pump efficiency to reduce abrasion. A velocity of 40 to 50 feet per second maximum through a jet pump is desirable. In the case of centrifugal pumps, the impeller peripheral speed should not exceed 4,500 to 5,000 feet per minute (40).

When system heads exceed about 100 feet, jet pumps are generally ineffective since series pumping is not practical. Centrifugal pumps, on the other hand, can be conveniently placed in series for high-head requirements (40).

Centrifugal pumps are generally used for recirculation. Clarity of recirculated water does not present a wear problem to a centrifugal ash handling pump.

Pipe. The pipe conveying an ash slurry is similar to that used in dry fly ash systems. Basic pipe for ash handling service has a Brinnell Hardness Number (BHN) of 200; fittings have a BHN

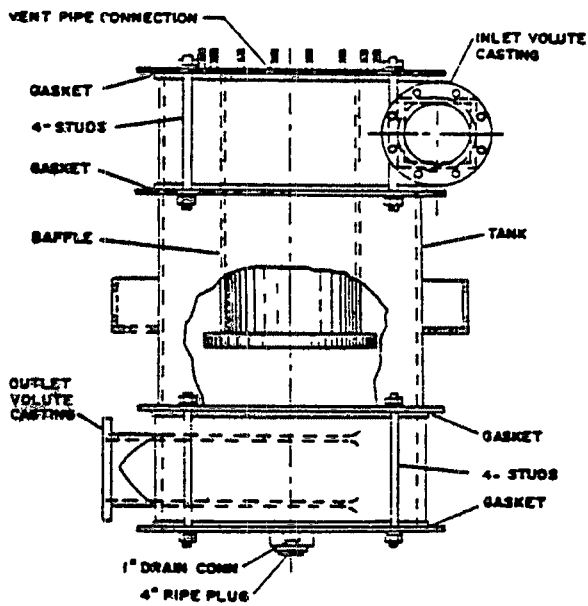
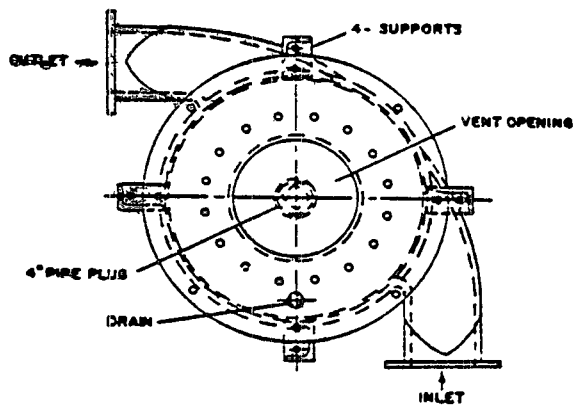

Figure VII-34  
 TYPICAL AIR SEPARATOR IN A PARTIAL RECIRCULATING  
 FLY ASH HANDLING SYSTEM

Reprinted from A Primer for Ash Handling by Allen-Sherman-Hoff Company by permission of Allen-Sherman-Hoff Company, a Division of Ecolaire. Year of first publication 1976

around 400. Various hardnesses are available with cost usually increasing in proportion to hardness (40). Centrifugally cast iron pipe is by far the most widely used pipe for wet systems because of its ability to withstand the corrosive and erosive condition often encountered in ash handling (39). This type of pipe is available from a number of pipe manufacturers. Basalt-lined pipe is another fairly common pipe used in ash handling systems. The basalt lining is formed from volcanic rock which is melted and shaped into a liner for the pipe. Basalt provides improved protection from abrasion; however, it is generally less resistant to impact caused by turbulent conditions at bends in the pipe. In fact, some plants have used basalt-lined pipes for straight sections and cast iron for bends. Basalt also protects against corrosion by sealing the pipe from the corrosive conditions within. One drawback from this pipe is that it is more expensive to install because it requires a lot of shaping and cutting. Some firms are marketing a ceramic pipe for use in ash handling systems. This type of pipe is fairly new and has not been universally accepted by the utility companies. Fiberglass pipe has also been used in ash handling systems. Like basalt-lined pipe, fiberglass pipe has fairly high installation costs because it requires cutting and shaping.

**Ponds.** The primary pond or settling area may not necessarily be a pond, per se, but can be a run-off area for removal of the larger ash particles. The sluice water may then overflow via gravity to a secondary pond for further settling. Overflow from the second pond would flow to a clear pond which serves as a holding basin for recirculation water. To be effective, ponds must cover a considerable area to allow sufficient retention time for settling of the ash in the conveying water. For bottom ash, volume in the storage basin should be sufficient to provide at least 1 day's retention time. Because of its slow settling rate, fly ash requires a larger pond to provide longer retention time than for bottom ash.

**Maintenance.** For those sections of a partial recirculating system which involve dry conveying, maintenance of the equipment is the same as for vacuum and pressure dry fly ash handling systems. Abrasive and corrosive wear on the pumps and conveying lines handling the ash sluice is a major source of maintenance problems. Most of the wear on pipe lines occurs along the bottom because most of the solids in the slurry are carried along the bottom. To distribute the wear along the bottom, many plants rotate their cast iron pipe lines regularly. The other area of major maintenance are the settling ponds. Generally, these ponds must be dredged regularly to remove settled ash for landfill disposal.

Retrofitting. The motivation for retrofitting a partial recirculating system onto an existing ash pond system may be either a water shortage or regulations governing wastewater effluents. Essentially no equipment must be removed in order to retrofit a partial recirculating system other than rerouting of old pipe near the sluicing pumps where hook up would occur. Old pipe in the plant may be used in some instance to help defray the capital cost of the new pipe. Recirculation pumps may be required to move the pond water to the existing ash sluice pumps. Some downtime may be required for hook up of the recycle line to the main sluice water conveying pumps.

Trip Report. One of the plants visited in the effort to define various bottom ash and fly ash handling practices had a partial recirculating system for fly ash. Plant 1505 is a 736 MW electric power generating station. Four of the seven boilers currently in operation burn bituminous coal from Bureau of Mines Districts 10 and 11 with an ash content of 10 to 12 percent. The boilers are of the wet bottom, cyclone type and produce a relatively large amount of bottom ash slag. The plant utilizes a wet recirculating ponding system to handle both fly ash and bottom ash. Water is obtained from a nearby creek for use in the sluicing operation. Figure VII-35 presents a flow diagram indicating separate fly ash and bottom ash holding ponds. There are two primary, two secondary, and one final pond.

The fly ash is jet sluiced from the ESP hoppers from Units 4, 5, 6, and 12 to one of two fly ash settling ponds. The sluice water from the fly ash pond is overflowed by gravity to the final pond for holding and recirculation to the jet pumps and ESP hoppers. The final pond also contains bottom ash sluice water. The same discharge point exists for the fly ash system as for the bottom ash. The final pond and recycle lines were retrofitted in 1974 in order to collect the discharge streams in one location for treatment purposes. The distance from the ESP hoppers to the fly ash ponds is approximately 1,500 feet. The fly ash is sluiced six times a day in 12-inch diameter sluice lines of cast basalt construction for 45-minute sluicing intervals. Thirty fly ash hoppers collect the fly ash at the ESP for Unit 12 and 12 hoppers collect for Units 4, 5, and 6.

Since the coal-fired boilers are all cyclone type, a small percentage of fly ash is produced relative to the bottom ash. In 1978, approximately 48,600 tons of fly ash was produced which represents 26 percent of all the ash produced. This fly ash is cleaned out of one pond annually and is trucked to a landfill site by an outside firm.

The sluicing jets and recirculation pumps are the primary maintenance items for this system. Minor erosion has caused some

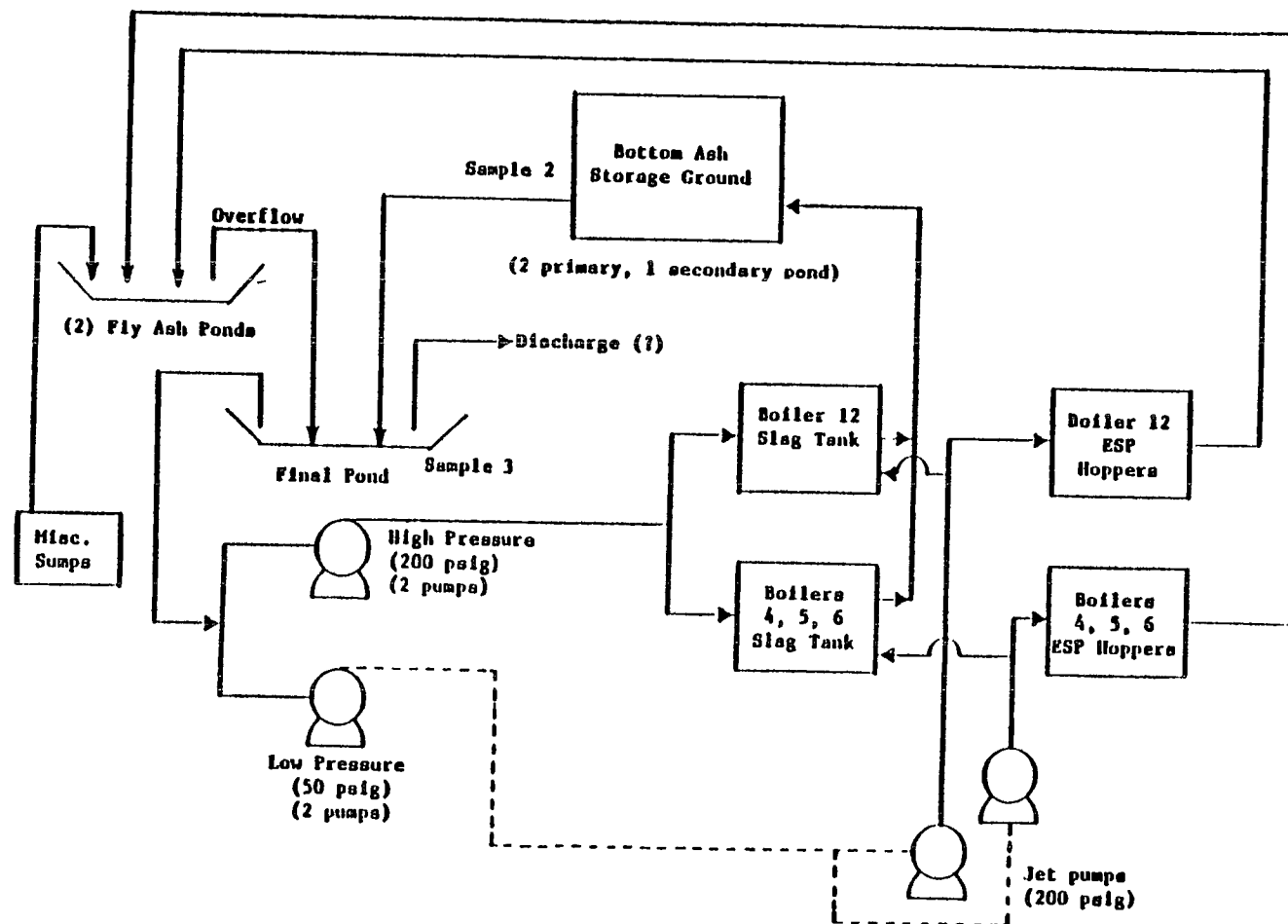

NOTE: Approximately 1/4 mile from slag tanks and ESP hoppers to the pond area

Figure VII-35  
ASH HANDLING SYSTEM FLOW DIAGRAM AND SAMPLING LOCATIONS FOR PLANT 1809

maintenance problems. Scaling and corrosion have not been found to be prevalent.

#### Physical/Chemical Treatment of Fly Ash Pond Overflows from Wet, Once-Through Systems

Wet, once-through systems with ponding are commonly used for ash handling. Typically, sluiced fly ash is sent to primary and secondary ponds arranged in series where settling of the larger particles occurs. The overflow from the secondary pond is then discharged. Physical/chemical treatment of the ash pond overflow may be employed to remove trace metals before the sluice water is discharged. This section describes physical/chemical treatment and the equipment involved and assesses the effectiveness of physical/chemical treatment in removing arsenic, nickel, zinc, copper, and selenium from ash pond overflows.

Process Description. Metals typically are removed from wastewater by raising the pH of the wastewater to precipitate them out as hydroxides. Lime is frequently used for pH adjustment. A flow diagram of a typical physical/chemical treatment system for metals removal using lime is shown in figure VII-36. The major equipment items include a lime feed system, mix tank polymer feed system, flocculator/clarifier, deep bed filter, acid feed system, and another mix tank. The underflow from the clarifier may require additional treatment with a gravity thickener and a vacuum filter to provide sludge which can be transported economically for landfill disposal. Typically, wastewater pH's of 9 to 12 are required to achieve the desired precipitation levels. Lime dosage rates, flocculant dosage rates, and clarifier design parameters are determined by jar tests and onsite pilot test on the ash sluice water discharge.

Equipment. Typically, hydrated or pebble lime is used to raise low pH systems to the desired pH. Hydrate lime feed systems are used when lime feed rates are less than 250 pounds per hour (41). Pebble lime feed systems are used for lime feed rates greater than 250 pounds per hour. A typical pebble lime feed system is illustrated in figure VII-37. For larger systems, the reduced chemical cost and ease of handling of pebble lime make the pebble lime systems more desirable.

Wastewaters which have a pH greater than 9 after lime addition will require acid addition to reduce the pH before final discharge. The system differs from lime feed systems in that the acid is delivered to the plant as a liquid. The feed system equipment must be constructed of special materials, typically rubber or plastic-lined carbon steel or stainless steel alloys. Acid addition rates for pH adjustment are highly dependent upon

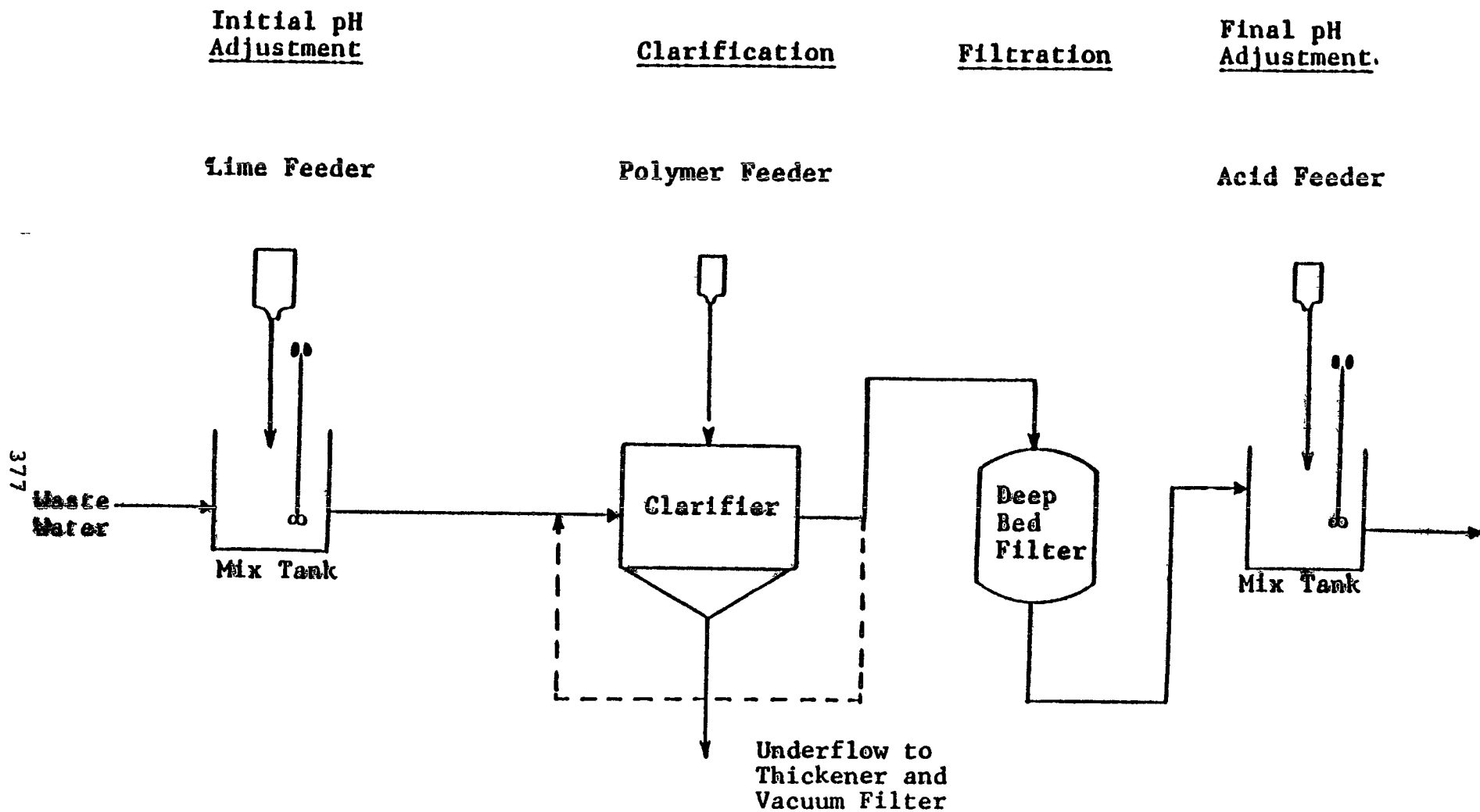

Figure VII-36  
 FLOW DIAGRAM OF A TYPICAL PHYSICAL/CHEMICAL TREATMENT SYSTEM FOR  
 METALS REMOVAL USING LIME

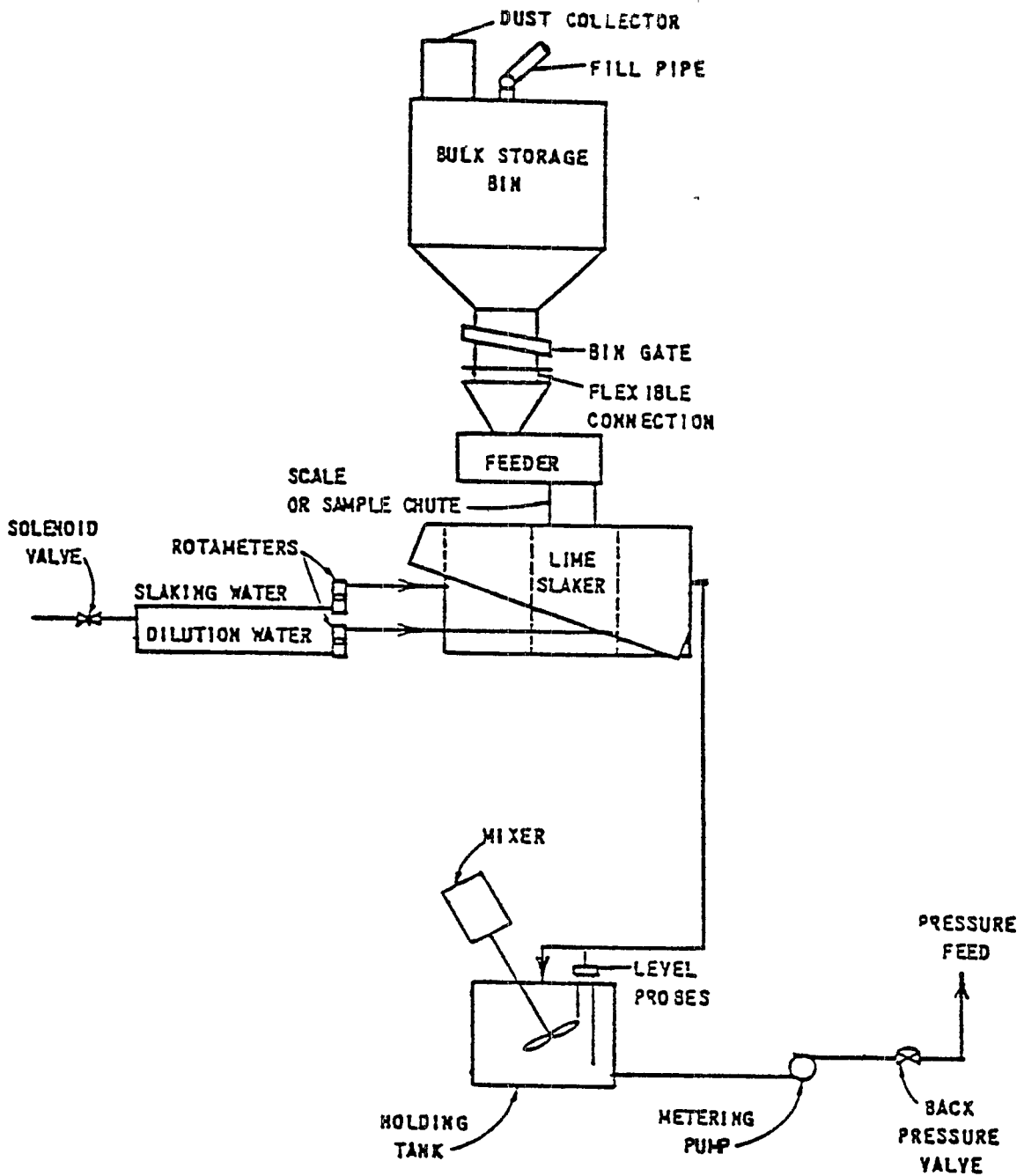

Figure VII-37  
TYPICAL LIME FEED SYSTEM (41)



wastewater flow, pH, alkalinity, and type and strength of acid. Dosage rates are determined by laboratory or onsite testing.

For wastewaters which have a pH of less than 6, mixers and mixing tanks are made of special materials of construction (stainless steel or lined-carbon steel). For wastewaters with pH's greater than 6, concrete tanks are typically used.

Polymer addition may be required to enhance the settling characteristics of the metal hydroxide precipitate. Typical polymer feed concentrations in the wastewater are 1 to 4 ppm. The required polymer addition rate is determined using laboratory or onsite testing.

The metal hydroxide precipitate is separated from the wastewater in the clarifier. Unlike settling ponds, these units continually collect and remove the sludge formed. To determine the size of the unit required, laboratory settling tests are required. These tests will define the required surface area. Typically, a 2- to 3-hour wastewater retention time will be required (39). Clarifier diameters range from 10 to 200 feet with average side water depths of 10 to 15 feet (39).

Filters are typically used for effluent polishing and can reduce suspended solids levels below 10 mg/l. Figure VII-38 illustrates a typical deep bed filter. Sand or coal are the most common filter media. Hydraulic loading rates of 2 to 20 gpm per square foot of bed cross sectional area are common. High removal efficiencies require lower hydraulic loading rates. For general design purposes, a hydraulic loading of 5 gpm per square foot of filter area is typical. As the filter medium becomes plugged with suspended solids, the pressure drop across the bed increases. At 10 to 15 psi bed differential pressure, the bed is automatically backwashed with water and air to remove the trapped suspended solids. Typically, 6 to 8 scfm of air and 6 to 8 gpm of water are required to backwash a square foot of bed cross section. Total backwash water consumption is usually in the range of 150 to 200 gallons per square foot of filter surface area. Backwash frequency can range from 1 to 6 times per day for normal operations. For backwash systems using only water, 15 to 20 gpm per square foot of filter area is required with a backwash water rate of 400 to 500 gallons per square foot of filter area (39).

Gravity thickeners are essentially identical to clarifiers in design. Sludge enters the middle of the thickener and the solids settle into a sludge blanket at the bottom. The concentrated sludge is very gently agitated by a moving rake which dislodges gas bubbles and keeps the sludge moving to the center well through which it is removed. The average retention time of solids in the thickener is between 0.5 and 2 days (42). Most

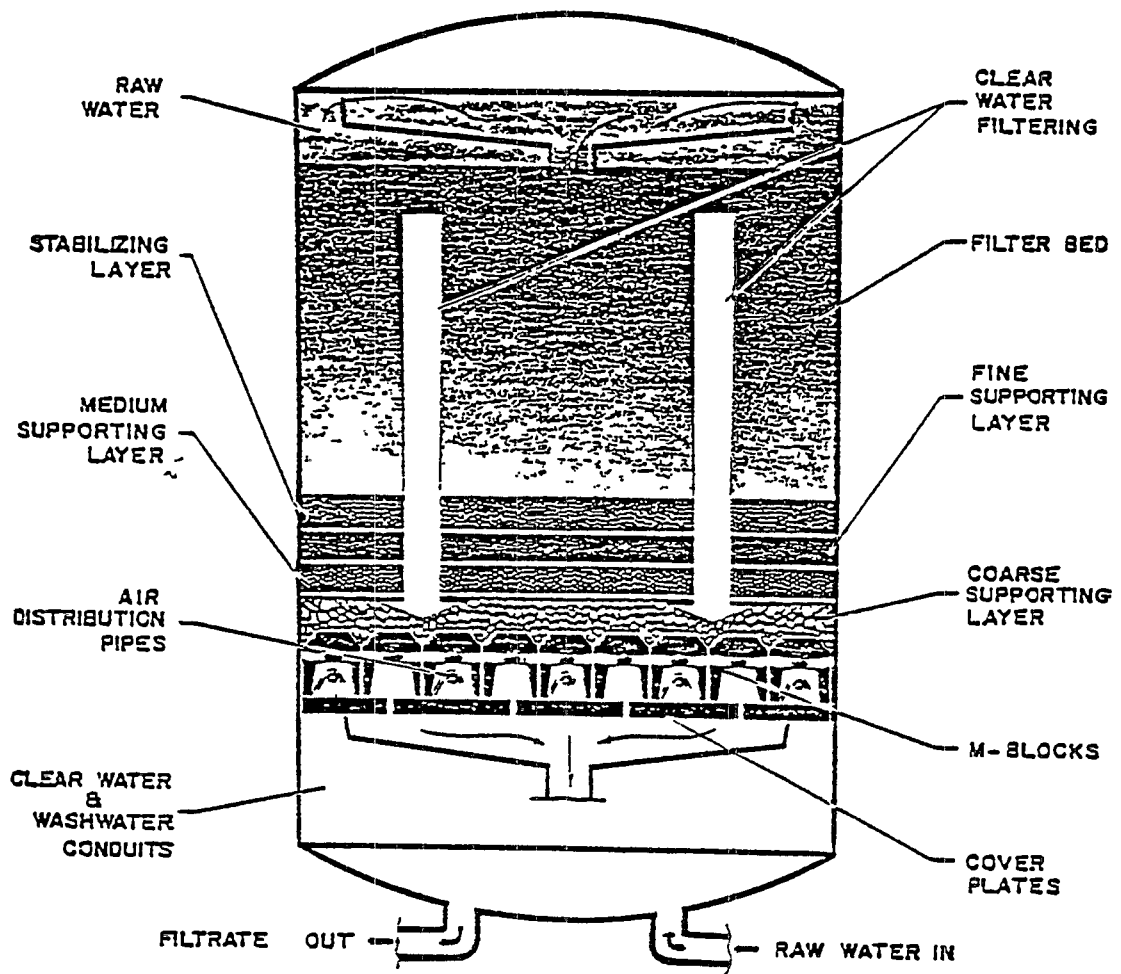

Figure VII-38  
DEEP BED FILTER

continuous thickeners are circular and are designed with side water depths of 10 feet (42). In thickening of lime sludge from lime tertiary treatment, incoming sludge of 1 to 2 percent solids has been thickened to 8 to 20 percent solids at solids loadings of 200 ppd/feet<sup>2</sup> (43).

Vacuum filtration is a common technique for dewatering sludge to produce a cake that has good handling properties and minimum volume. The vacuum filter typically consists of a cylindrical drum that rotates with the lower portion of the drum submerged in the feed sludge. The drum is covered with a porous filter medium. As the drum rotates, the feed liquor is drawn onto the filter surface by a vacuum that exists on the drum interior. The liquid passes through the filter and the sludge forms a cake on the surface of the drum. The cake is separated from the filter by a scraper. Generally, vacuum filters are capable of dewatering a 2 to 4 percent solids feed to a filter cake with a concentration of 19 to 36 percent solids. Typical solids loading rates may vary from 3 to 14 pounds per hour feet squared for lime sludges.

Effectiveness. A review of the literature on trace metals removal from various wastewaters using physical/chemical treatment was conducted for arsenic, nickel, zinc, copper, and selenium. The results of this literature review and the results of benchscale studies of trace metal removals in ash pond overflows are discussed in this subsection.

Arsenic. Arsenic and arsenical compounds have been reported as waste products of the metallurgical industry, pesticide production, petroleum refining, and the rare-earth industry. High levels of arsenic also have been reported in raw municipal wastewater. Arsenic occurs in four oxidation states, but it is found primarily in the trivalent (arsenite) and pentavalent (arsenate) forms. It is found in organic and inorganic compounds. The inorganic compounds are generally more hazardous than the organic compounds, and the trivalent form is generally more toxic than the pentavalent form. Information on the conventional coagulant and lime-softening processes indicates that removal is valance dependent (44).

While only limited information is available on the concentration of arsenic in industrial wastewater and on current treatment processes, more up-to-date information is available on the removal of arsenic in municipal wastewater. One study (45) of the lime softening process indicates removals of approximately 85 percent. In particular, the lime softening process was found to reduce an initial arsenic concentration of 0.2 mg/l down to 0.03 mg/l. Simple filtration through a charcoal bed reduced the same initial arsenic concentration to 0.06 mg/l. Results from another

pilot plant study (45) for removal of arsenic in municipal wastewaters indicate removal efficiencies of 96 to 98 percent (final effluent concentration = 0.06 mg/l). The treatment involved addition of coagulant (ferric sulfate), followed by flocculation, settling, dual media filtration, and carbon adsorption.

The Water Supply Research Division (WSRD) of EPA recently completed pilot plant studies on arsenic removal (44). In one study, sample effluents were pumped to a rapid-mix tank then flowed by gravity through coagulation, flocculation, and sedimentation steps to filter columns. WSRD reported removals as high as 96 percent for an initial concentration of 0.39 mg/l of arsenate and 82 percent for an initial concentration of 0.12 mg/l of arsenite. The study confirmed that:

- o Arsenic V is more easily removed than Arsenic III by alum and ferric sulfate coagulation.
- o Ferric sulfate is more effective for removal of Arsenic III.

The average removal efficiency of Arsenic V was approximately 69 percent (minimum removal = 11 percent, maximum removal = 96 percent). The average removal efficiency of Arsenic III was approximately 48 percent (minimum removal = 1 percent, maximum removal = 82 percent). WSRD also investigated the use of lime softening techniques. Removals of 71 percent for Arsenic III and 99 percent for Arsenic V were reported after settling and dual-media filtration. The average removal efficiency for Arsenic III was about 50 percent; and for Arsenic V, about 76 percent.

In pilot plant studies in Taiwan, the only technique continuously capable of high arsenic removal was ferric chloride coagulation, preceded by chlorine oxidation (for oxidation of Arsenic III to Arsenic V), followed by sedimentation and filtration (44). Based on these studies, a full-scale arsenic removal plant for treatment of municipal wastewater, handling 150 m<sup>3</sup>/day of water, was built in Taiwan. During the first 59 days of operation, 82 to 100 percent removal was achieved (with initial concentrations from 0.60 to 0.94 mg/l).

In a bench scale study conducted for EPA of priority heavy metals removal, chemical precipitation was evaluated for arsenic removal from three ash pond effluents (48). This treatment method proved effective in reducing arsenic to the analytical detection limit. The results of this study are presented in greater detail later in this section.

A summary of arsenic treatment methods and removals is shown in table VII-15.

Table VII-15

## ARSENIC REMOVAL FROM MUNICIPAL WASTEWATERS (44, 45)

<u>Treatment Method</u>	<u>Initial Arsenic Concentration (mg/l)</u>	<u>Final Arsenic Concentration (mg/l)</u>	<u>Percent Removal</u>
Lime Softening	0.2	0.03	85
Lime Softening			
As V	0.58	----	99
As III	0.34	0.10	71
Coagulation with Ferric Chloride	1.5-3.0	0.06	96-98
Coagulation with Ferric Chloride			
As V	0.39	0.02	96
As III	0.12	0.02	82
Chlorine Oxidation and Ferric Chloride Coagulation	0.06-0.94	----	82-100
Charcoal Filtration	0.2	0.06	70

Nickel. Wastewaters containing nickel are found primarily in the metal industries, particularly in plating operations. A list of industries and their average wastewater nickel concentrations is given in table VII-16. Nickel exists in wastewater as the soluble ion. In the presence of complexing agents such as cyanide, nickel may exist in a more soluble complexed form; therefore, pretreatment to remove these agents may be necessary. The formation and precipitation of nickel hydroxide is generally the basis for destructive treatment of nickel wastes (as opposed to carbonates and sulfates, which are used in the recovery of nickel). Table VII-17 summarizes actual full-scale results of lime precipitation. The theoretical solubility limit for nickel is approximately 0.001 mg/l (46). Complete removal of nickel has been reported with ion exchange treatments. Though this is generally more expensive, the cost is offset by the value of the recovered nickel. Since recovery of nickel from ash pond effluents is not practical, such a treatment would probably be uneconomical for steam electric powerplants.

Pilot plant studies (45) have been conducted on the use of reverse osmosis for removal of nickel from wastewater. The studies indicate removals of greater than 99 percent. It should be noted, however, that reverse osmosis units typically blowdown 10 to 40 percent of the volume of wastewater treated. Reverse osmosis simply concentrates materials in a dilute stream.

Zinc. Waste concentrations of zinc range from 1 to 1,000 mg/l in various waste streams described in the literature, but average values fall between 1 and 100 mg/l as shown in table VII-18. Table VII-19 summarizes published precipitation treatment results. As with nickel, cyanide forms a more soluble complex ion with zinc; therefore, cyanide treatment may be required before precipitation of zinc.

A treatment combining hydroxide and sulfide precipitation of heavy metals, known as the "Sulfex" process, has reported effective removal of zinc, chromium, and other trace metals. The Sulfex process has been used to treat water rinses following carburetor-casting treatment tanks in an automotive plant in Paris, Tennessee. The waste stream in this plant has a zinc concentration of 34 mg/l. Treatment has resulted in a filtered effluent concentration of less than 0.05 mg/l of zinc (47).

Copper. Primary sources of copper in industrial waste streams are metal process pickling and plating baths. For a given bath, the rinse water concentration will be a function of many factors, such as drainage time over the bath, shape of the parts, surface area of the parts, and the rate of rinse water flow. Untreated process waste water concentrations of copper typical of plating and metal processing operations are summarized in table VII-20.

Table VII-16

SUMMARY OF NICKEL CONCENTRATIONS IN METAL  
PROCESSING AND PLATING WASTEWATERS (45)

(mg/l)

<u>Industry</u>	<u>Nickel Concentration</u>	
	<u>Range</u>	<u>Average</u>
<u>Tableware Plating</u>		
Silver bearing waste	0-30	5
Acid Waste	10-130	33
Alkaline waste	0.4-3.2	1.9
<u>Metal Finishing</u>		
Mixed wastes	17-51	-
Acid wastes	12-48	-
Alkaline wastes	2-21	-
Small parts fabrication	179-184	181
Combined degreasing, pickling and Ni dipping of sheet steel	3-5	-
<u>Business Machine Manufacture</u>		
Plating wastes	5-35	11
Pickling wastes	6-32	17
<u>Plating Plants</u>		
4 different plants	2-205	-
Rinse waters	2-900	-
Large plants	up to 200	25
5 different plants	5-58	24
Large plating plant	88 (single waste stream)	-
	46 (combined flow)	-
Automatic plating of Zinc base castings	45-55	-
Automatic plating of ABS type plastics	30-40	-
Manual barrel and rack	15-25	-

Table VII-17

SUMMARY OF EFFLUENT NICKEL CONCENTRATIONS AFTER  
PRECIPITATION TREATMENT (45)

<u>Source</u>	<u>Nickel Concentration (mg/l)</u>		<u>Percent Removal</u>	<u>Comment</u>
	<u>Initial</u>	<u>Final</u>		
Tableware Plating	21	0.09-1.9	91-99.6	FeCl <sub>3</sub> + Sand Filtra- tion
Appliacne Manu- facutring	35	0.4	98.9	----
Office Machine Manufacutring	39	0.17	99.6	
Non-Ferrous Metal Plating	--	0.5-0.13	----	6 hour Works settling
Record Changer Manufacturing	--	0.1-0.2	----	6 hour detention in clarifier



Table V-18

## CONCENTRATIONS OF ZINC IN PROCESS WASTEWATERS (45)

(mg/l)

<u>Industrial Process</u>	<u>Zinc Concentration</u>	
	<u>Range</u>	<u>Average</u>
<u>Metal Processing</u>		
Bright dip wastes	0.2-37.0	
Bright mill wastes	40-1,463	
Brass mill wastes	8-10	
Pickle bath	4.3-41.4	
Pickle bath	0.5-37	
Pickle bath	20-35	
Aqua fortis and CN dip	10-15	
Wire mill pickle	36-374	
<u>Plating</u>		
General	2.4-13.8	8.2
General	55-120	
General	15-20	15
General	5-10	
Zinc	20-30	
Zinc	70-150	
Zinc	70-350	
Brass	11-55	
Brass	10-60	
General	7.0-215	46.3
Plating on zinc castings	3-8	
Galvanizing of cold rolled steel	2-88	
<u>Silver Plating</u>		
Silver bearing wastes	0-25	9
Acid waste	5-220	65
Alkaline	0.5-5.1	2.2
<u>Rayon Wastes</u>		
General	250-1000	
General	20	
General	20-120	

Table VII-19

## SUMMARY OF PRECIPITATION TREATMENT RESULTS FOR ZINC (45, 47)

<u>Source</u>	<u>Zinc (mg/l)</u>		<u>Percent Removal</u>	<u>Comment</u>
	<u>Initial</u>	<u>Final</u>		
Zinc Plating	----	0.2-0.5	----	----
General Plating	18.4	2.0	89	
General Plating	----	0-6	----	Sand Filtration
General Plating	55-120	≤1.0	99	
Vulcanized Fiber	100-300	≤1.0	99	
Brass Wire Mill	36-374	0.08-1.60	99	Integrated Treatment for Copper Recovery
Tableware Plant	16.1	0.02-0.23	99	Sand Filtration
Viscose Rayon	20-120	0.88-1.5	----	
Viscose Rayon	70	3-5	93-96	
Viscose Rayon	20	1.0	95	
Metal Fabrication	----	0.5-1.2 0.1-0.5		(1) Sedimentation (2) Sand Filtration
Automotive Industry (Sulfex Process)	34	0.05	99	

Table VII-20

COPPER CONCENTRATIONS IN WASTEWATER FROM METAL PLATING  
AND PROCESSING OPERATIONS

(mg/l)

<u>Process</u>	<u>Copper Concentration</u>
Plating Rinse	20-120
Plating Rinse	0-7.9
Plating Rinse	20 (ave.)
Plating Rinse	5.2-41
Plating	6.4-88
Plating	2.0-36.0
Plating	20-30
Plating	10-15
Plating	3-8
Plating	11.4
Appliance Manufacturing	
Spent Acids	0.6-11.0
Alkaline Wastes	0-1.0
Automobile Heater Production	24-33 (28 ave.)
Silver Plating	
Silver Bearing	3-900 (12 ave.)
Acid Wastes	30-590 (135 ave.)
Alkaline Wastes	3.2-19 (6.1 ave.)
Brass Plating	
Pickling Bath Wastes	4.0-23
Bright Dip Wastes	7.0-44
Plating Wastes	2.8-7.8 (4.5 ave.)
Pickling Wastes	0.4-2.2 (1.0 ave.)
Brass Dip	2-6
Brass Mill Rinse	4.4-8.5
Brass Mill Rinse	
Tube Mill	74
Rod and Wire Mill	888
Brass Mill Bichromate Pickle	
Tube Mill	13.1
Rod and Wire Mill	27.4
Rolling Mill	12.2
Copper Rinse	13-74
Brass Mill Rinse	4.5

Table VII-20 (Continued)

COPPER CONCENTRATIONS IN WASTEWATER FROM METAL PLATING  
AND PROCESSING OPERATIONS

(mg/l)

<u>Process</u>	<u>Copper Concentration</u>
Brass and Copper Wire Mill	72-124
Brass and Copper Pickle	60-9
Brass and Copper Bright Dip	20-35
Copper Mill Rinse	19-74
Copper Tube Mill	70 (ave.)
Copper Wire Mill	800 (ave.)
Copper Ore Extraction	0.28-0.33
Gold Ore Extraction	20
Acid Mine Drainage	3.2
Acid Mine Drainage	3.9
Acid Mine Drainage	0.12
Acid Mine Drainage	51.6-128.0

As with most heavy metal wastes, treatment processes for removal of copper may be of a destructive nature, involving precipitation and disposal of resulting solids, or of a recovery nature, e.g., ion exchange, evaporation, and electrolysis. Ion exchange or activated carbon are appropriate treatment methods for wastewaters containing copper at concentrations less than 200 mg/l; precipitation is applicable for copper levels of 1.0 to 1,000 mg/l, and electrolytic recovery is advantageous for copper treatment at concentrations above 10,000 mg/l (45).

Generally, hydroxide precipitation is accomplished by lime addition to an acidic wastewater. The theoretical solubility limit of the metal ion is approximately 0.0004 mg/l at a pH of approximately 9.0 (46). Theoretical levels are seldom achieved due to colloidal precipitates, slow reaction rates, pH fluctuations, and the influence of other ions. Reported treatment levels achieved by full-scale industrial treatment operations are presented in table VII-21.

Selenium. Industries which use selenium include paint, pigment and dye producers, electronics, glass manufacturers, and insecticide industries. Selenium is similar to arsenic in several ways. For example, the two predominant oxidation states in water are Selenium IV (selenite) and Selenium VI (selenate) and selenium appears in the anion form and thus has acid characteristics. Very little information is available on levels of selenium in industrial wastewaters or treatment methods for selenium wastes.

Secondary municipal sewage treatment plants with 2 to 9 ug/l of selenium in the effluent have been reported (45). A tertiary sequence of treatment which included lime treatment to pH 11, sedimentation, mixed-media filtration, activated carbon adsorption and chlorination yielded selenium removals of 0 to 89 percent. In another study (45), various advanced treatments were tested for a sewage treatment plant effluent with a selenium concentration of 2.3 ug/l. The investigators concluded that efficient removal (>99 percent) could be achieved using a strong acid-weak base ion exchange system (45).

Jar tests and pilot plant tests conducted by WSRD on the removal of selenium from ground and surface waters by conventional coagulation showed that selenium removal is dependent on the oxidation state, initial concentration of selenium, pH, and types and doses of coagulation (44). Removals range from 0 to 81 percent using ferric sulfate and alum coagulants. In general, ferric sulfate was more efficient than alum in removing Selenium IV. Both ferric sulfate and alum yielded removals of 11 percent or less for Selenium VI. Initial selenium concentrations ranged from 0.03 to 0.10 mg/l. With dual media and granular activated carbon filters, removals as high as 80 percent were obtained for

Table VII-21

COPPER REMOVAL BY FULL-SCALE INDUSTRIAL WASTEWATER  
TREATMENT SYSTEMS (45)

<u>Source and Treatment</u>	<u>Initial Copper conc. (mg/l)</u>	<u>Final Copper conc. (mg/l)</u>	<u>Removal Efficiency (%)</u>
Metal Processing (Lime)	204-385	0.5	98.7-99.8
Nonferrous Metal Processing (Lime)	-	0.2-2.3 (prior to sand filtration)	-
Metal Processing (Lime)	-	1.4-7.8 (prior to sand filtration) 0.0-0.5 (after sand filtration)	-
Electroplating (caustic, Soda Ash + Hydrazine)	6.0-15.5	0.09-0.25 (sol.) 0.30-0.45 (tot.)	-
Machine Plating (Lime + coagulant)	-	2.2	-
Metal Finishing (Lime)	-	0-12 (ave. 0.19)	-
Brass Mill (Lime)	10-20	1-2	-
Plating	-	0.02-0.2	-
Plating (CN oxidation, Cr reduction, neutralization)	11.4	2.0	82.5
Wood Preserving (Lime)	0.25-1.1 (range)	0.1-0.35	-
Brass Mill (Hydrazine + NaOH)	75-124	0.25-0.85	-
Silver Plating (CN oxidation, Lime, Fe Cl <sub>3</sub> )	30 (ave.)	0.16-0.3 (with sand filtration)	99-99.5

Selenium IV. WRDS also conducted pilot plant studies on lime-softening treatments for selenium removal. The results indicate that this is not an effective treatment for selenium removal (44). WSRD conducted studies which confirmed removals of greater than 99 percent using a cation-anion exchange system in series. Research on both laboratory and pilot plant scale is needed before feasibility of this treatment technique can be determined (44).

Ash Pond Overflows. The removal efficiencies which have been presented for arsenic, nickel, zinc, selenium and copper must be viewed with caution regarding application of removal efficiencies to fly ash and bottom ash pond discharges. Table VII-22 shows a comparison of the range of initial concentrations associated with the removal efficiencies which have been presented and the average concentrations of trace metals in fly ash and bottom ash pond discharges. The average concentrations in fly ash and bottom ash ponds are much lower than the ranges of initial concentrations contained in the literature; thus, the removal efficiencies do not necessarily reflect the efficiencies of such treatments for removal of trace metals in the ash ponds of steam electric powerplants. The final effluent concentration, however, would probably be lower for a powerplant because of the low initial concentration.

Bench scale studies of various removal technologies for treatment of ash pond effluents from steam electric powerplants have been conducted (48). Results of chemical precipitation treatments of the ash pond effluents from three powerplants located in Wyoming, Florida, and Upper Appalachia are shown in tables VII-23 and VII-24 for lime and lime and ferric sulfate addition, respectively. Arsenic removal appears to be reasonably good, ranging from 67 to less than 99 percent. Copper removals are variable, ranging from 31 to 80 percent. The efficiency of nickel removal is also uncertain. Selenium removal is, in general, fairly poor. This is consistent with other studies cited earlier on removal of selenium by chemical precipitation. The efficiency of zinc removal varies significantly from 14 to 92 percent. Though this study may indicate that chemical precipitation has potential for effective removal of some trace metals from ash ponds effluents, other studies are necessary to confirm these results.

Ash/Sludge Disposal. The two primary methods of ash disposal are landfill and utilization. Only a few plants presently sell or use fly ash. Ash which has been collected dry or has been dewatered is disposed of by landfill. Figure VII-39 illustrates some common landfill methods. Equipment requirements include closed trucks, graders, and bulldozers. Disposal of dry fly ash poses some fugitive dust problems. Closed trucks are used to prevent fugitive dust emissions enroute to the landfill site. At

Table VII-22

COMPARISON OF INITIAL TRACE METAL CONCENTRATIONS CITED  
 IN STUDIES REPORTED IN THE LITERATURE AND TRACE METAL  
 CONCENTRATIONS IN ASH POND DISCHARGES

(ppm)

<u>Metal</u>	<u>Initial Concentrations Treated</u>	<u>Average Bottom Ash Concentrations</u>	<u>Average Fly Ash Concentrations</u>
As	0.200 to 3.00	0.022	0.055
Ni	>21	0.079	0.224
Zn	18 to 374	0.020	0.034
Cu	0.25 to 385	0.012	0.003
Se	0.01 to 0.08	0.004	0.008



Table VII-23

TRACE METAL REMOVAL EFFICIENCIES FOR LIME PRECIPITATION  
TREATMENT OF ASH POND EFFLUENTS (48)

	<u>Inlet (ppb)</u>	<u>Outlet (ppb)</u>	<u>Removal Efficiency %</u>
Arsenic			
Wyoming	<1	1	DL
Florida	9	1	89
Appalachia	74	1	>99
Copper			
Wyoming	80	23	71
Florida	14	10	29
Appalachia	26	12	54
Nickel			
Wyoming	9.5	0.5	<95
Florida	5.5	6.0	OGTI
Appalachia	2.5	2.2	12
Selenium			
Wyoming	3	3	DL
Florida	8	8	NR
Appalachia	42	52	OGTI
Zinc			
Wyoming	300	31	90
Florida	7	2	57
Appalachia	11	<2	>82

---

KEY: DL - Concentrations of both inlet and outlet are below the detection limit.  
OGTI - Outlet concentrations greater than inlet.  
NR - No removal.

Table VII-24

TRACE METAL REMOVAL EFFICIENCIES FOR LIME PLUS  
FERRIC SULFATE PRECIPITATION TREATMENT OF ASH POND  
EFFLUENTS (48)

	Inlet (ppb)	Outlet (ppb)	Removal Efficiency %
<b>Arsenic</b>			
Wyoming	<1	<1	DL
Florida	9	3	67
Appalachia	74	<1	>99
<b>Copper</b>			
Wyoming	80	23	80
Florida	14	7	50
Appalachia	26	18	31
<b>Nickel</b>			
Wyoming	9.5	10.5	>95
Florida	5.5	9.0	OGTI
Appalachia	2.5	2.0	20
<b>Selenium</b>			
Wyoming	3	3	DL
Florida	8	7	12
Appalachia	42	32	24
<b>Zinc</b>			
Wyoming	300	25	92
Florida	7	6	14
Appalachia	11	<2	>82

KEY: DL - Concentrations of both inlet and outlet are below  
the detection limit.  
OGTI - Outlet concentrations greater than inlet.  
NR - No removal.

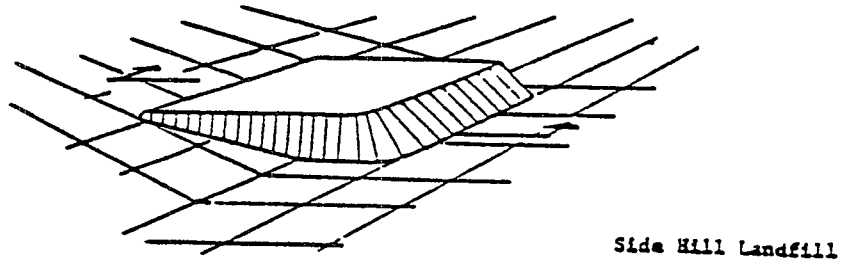

Side Hill Landfill

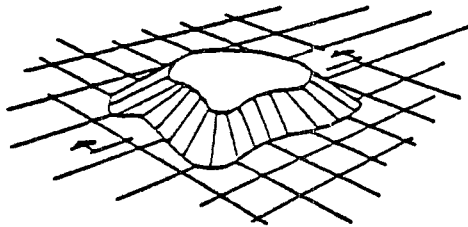

Heaped Landfill Configuration

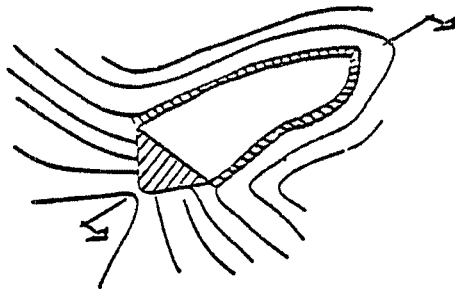
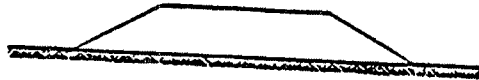

Valley Fill Disposal Configuration

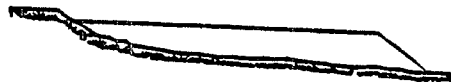

Figure VII-39  
LANDFILL METHODS

the site, the ash should be wetted down after application to the landfill.

### Bottom Ash

The technologies applicable to bottom ash handling systems are:

- o dry bottom ash handling,
- o Hydrobin/dewatering bin systems, and
- o ponding with recycle.

### Dry Systems

Dry handling of bottom ash is generally typical of stoker-fired boilers. This method is used by 19 percent of those plants which reported a bottom ash system type in the 308 survey (including all types of plants). Stoker-fired boilers are generally used in relatively small capacity installations where small amounts of bottom ash are handled. Since this technology represents a small and more obsolete sector of the industry, it is not addressed in further detail in this section.

### Complete Recycle Systems

The term "complete recycle" describes a system which returns all of the ash sluice water to the ash collecting hoppers for recurrent use in sluicing. The key concept of complete recycle is that there is no continuous discharge of sluice water from the system. Virtually no system is zero discharge from the standpoint of containing all ash handling water onsite because ash-laden water does leave the facility in a variety of ways. Water is occluded with the ash when trucked away to disposal. Under upset conditions, it is often necessary to discharge water. In some cases, small amounts of water from the ash handling system are needed elsewhere in the plant, typically for wetting fly ash handling trucks to prevent blowing of dry fly ash and for servicing the silo unloaders. Makeup water is required to maintain a steady water balance despite these inherent losses in the system. The magnitude of the makeup water requirement depends upon the major equipment in the ash handling system.

### Technology Descriptions.

Dewatering/Hydrobin System (36). The various stages of a closed-loop recirculating system appear in figure VII-40. For the sake of clarity, some details have been omitted. Initially, as illustrated in figure VII-40a, the ash hopper is filled to its overflow line, and one dewatering bin (bin A) is partially

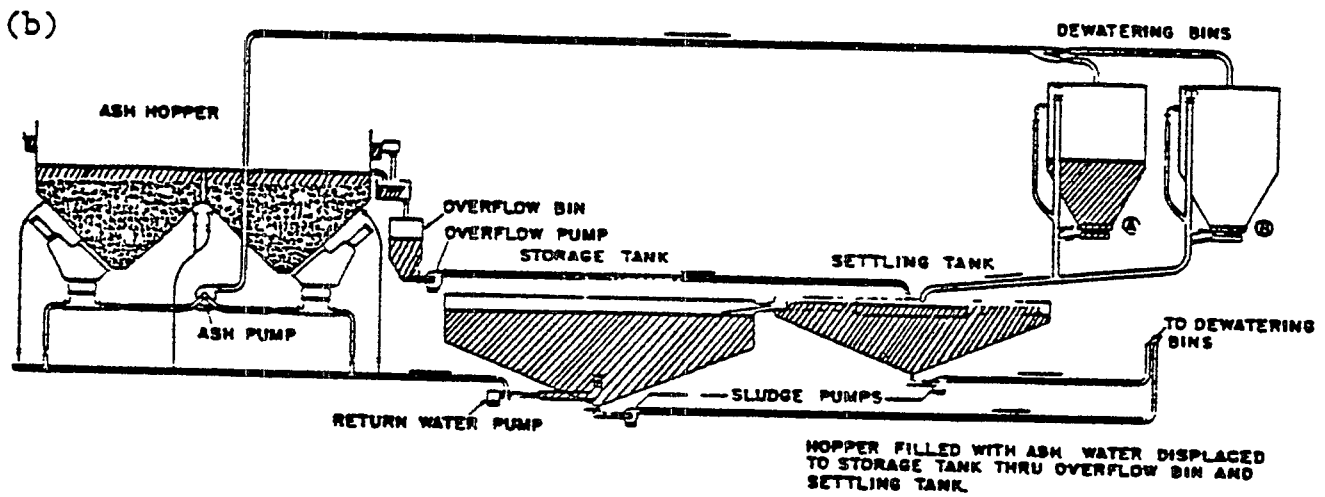
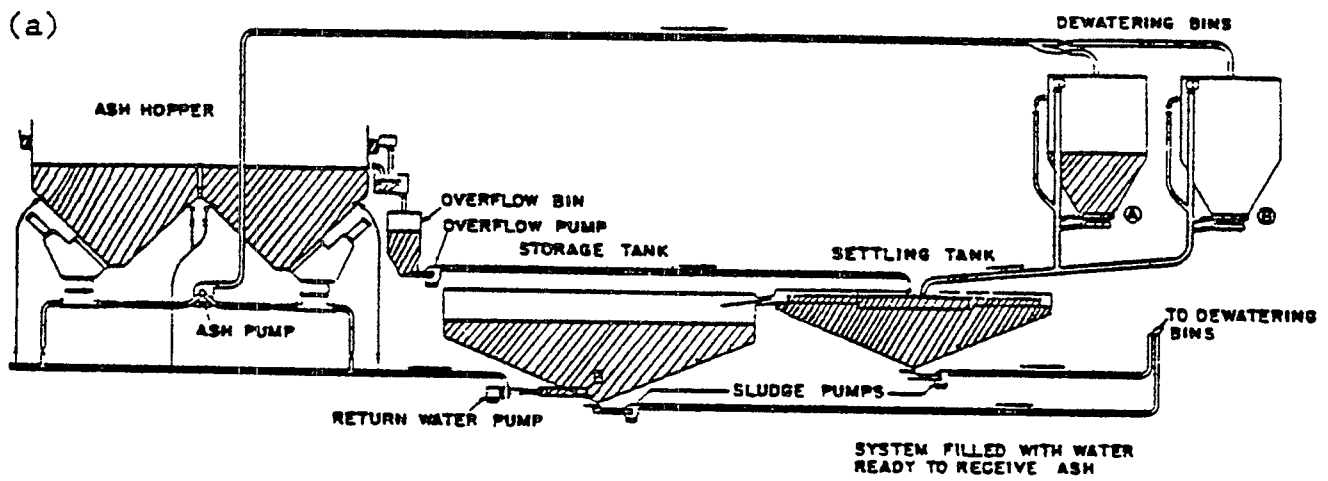
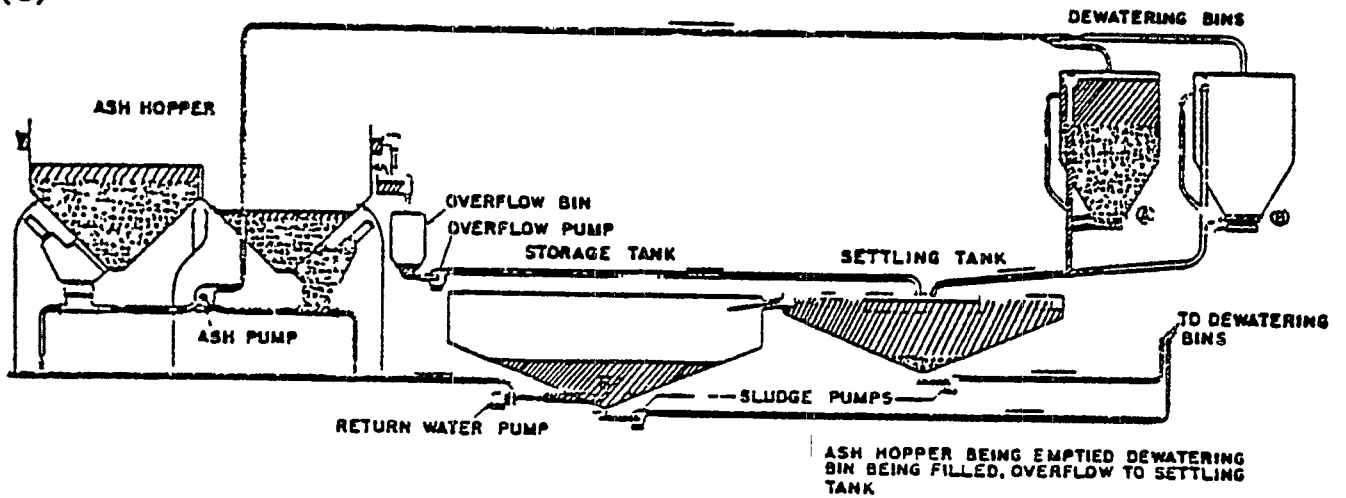

Figure VII-40  
VARIOUS STAGES OF A CLOSED-LOOP RECIRCULATING SYSTEM (36)

(c)



(d)

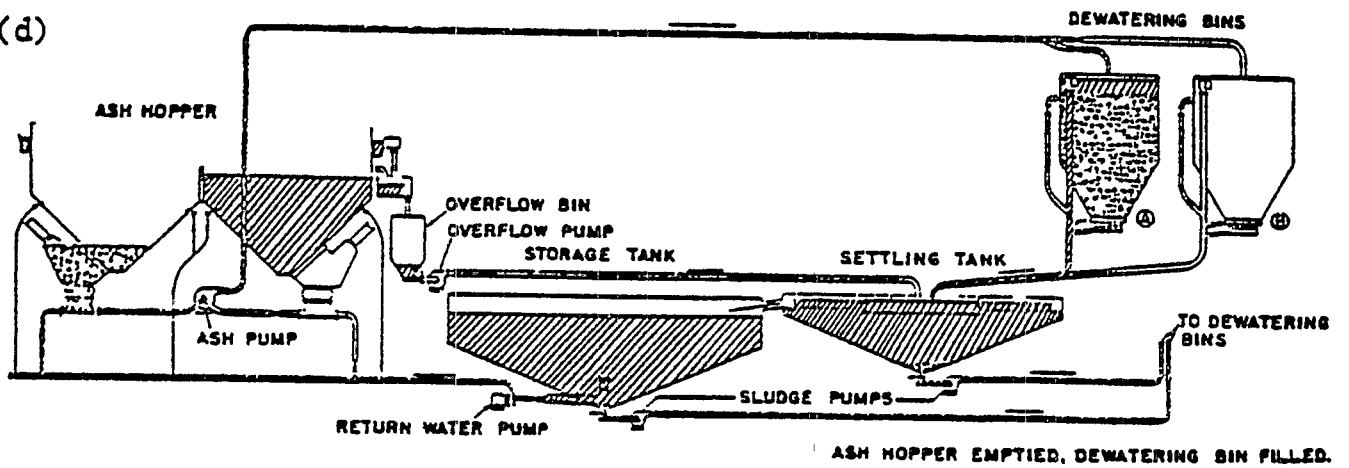
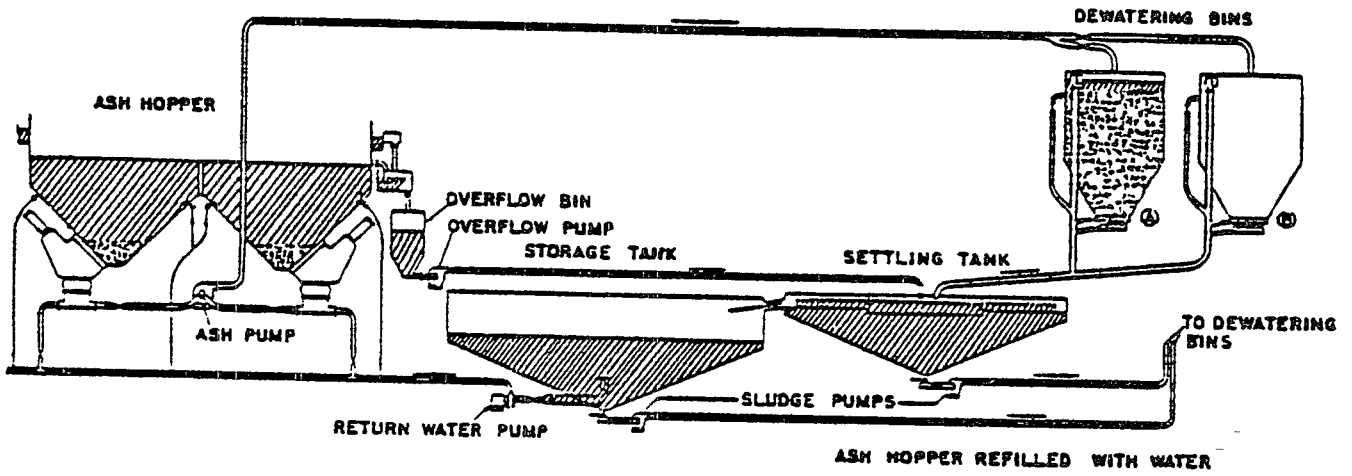

Figure VII-40 (Continued)  
VARIOUS STAGES OF A CLOSED-LOOP RECIRCULATING SYSTEM (36)

(e)



(f)

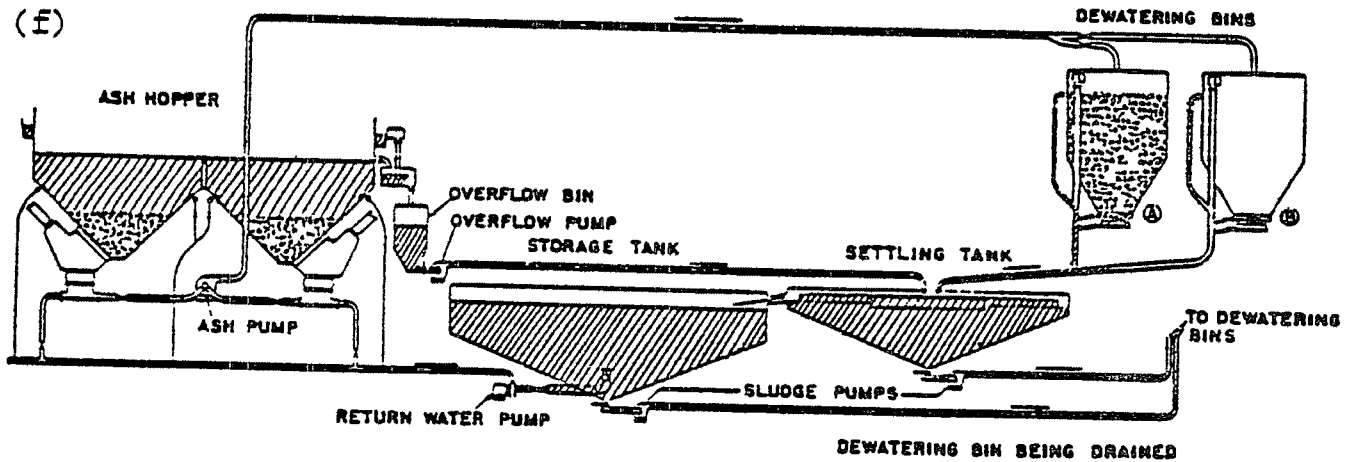

Figure VII-40 (Continued)  
VARIOUS STAGES OF A CLOSED-LOOP RECIRCULATING SYSTEM (36)

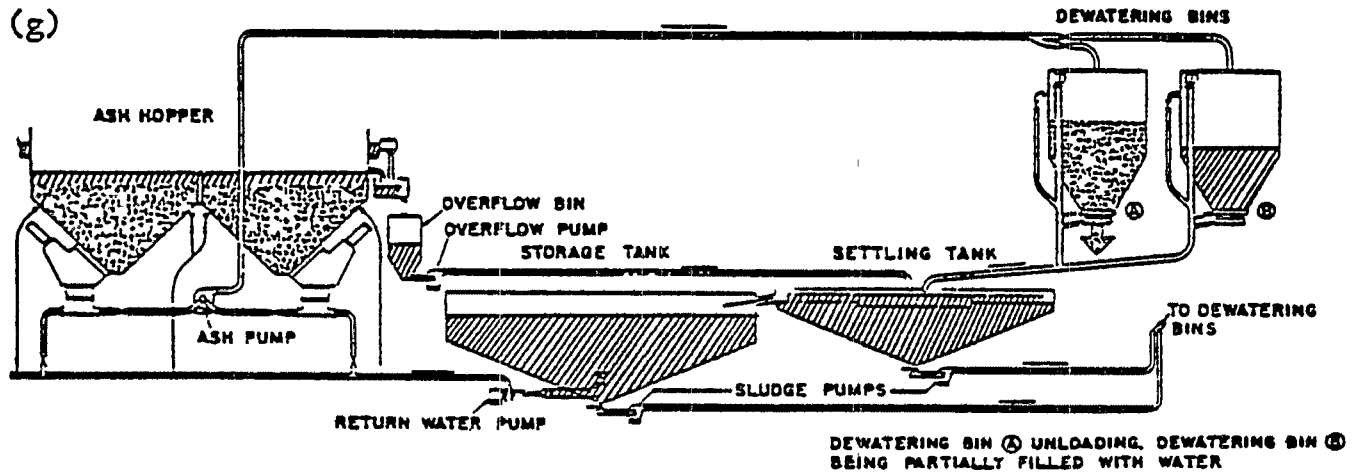

Figure VII- 40 (Continued)  
 VARIOUS STAGES OF A CLOSED-LOOP RECIRCULATING SYSTEM (36)



filled with water. Enough water remains in the storage tank to start operating the system after the ash hopper is filled with ashes. In the next stage, illustrated in figure VII-40b, the ash hopper has been filled with ashes, and the water displaced by them has been pumped into the settling tank and overflowed into the storage tank. In the next step, shown in figure VII-40c, ash hopper cleaning is in progress in the right hand chamber. Ashes are pumped to the Dewatering Bin A. As ash-water slurry enters the dewatering bin, an equal amount of water overflows to the settling tank and then to the storage tank. In figure VII-40d, the ash hopper has been completely emptied. All of the water that had been in the ash hopper is now in the storage tank. The water in the storage tank is used to refill the ash hopper as shown in figure VII-40f. The water in the ash hopper is then available for filling Dewatering Bin B as shown in figure VII-40g. The water volume in the settling tank remains constant while the volume in all other vessels varies during different phases of operation.

Outside makeup water is necessary to restore the water lost with the bottom ash discharged from the dewatering bins as well as water lost through evaporation from the bottom ash hopper. Makeup usually is added at the storage tank. An emergency bypass can be installed between the settling tank and the storage tank to provide needed water in the event of temporary failure outside makeup.

In most cases, a closed-loop recirculating system shows a marked change in the pH of the recirculated water. This pH shift is tempered by the addition of makeup water if it is added in sufficient quantity and is of good quality. A monitoring system and chemical additives can maintain recirculated water at as neutral a level as possible in order to keep pipe scaling or corrosion to a minimum.

Cases where pH adjustment is not sufficient for scale prevention, such as very reactive bottom ash or poor intake water quality, may require side stream lime/soda ash treatment. The equipment for slip stream softening has been described in the section concerning physical/chemical treatment of ash pond overflows from wet once-through fly ash handling systems. The magnitude of the flow rate of the slip stream is estimated to be about 10 percent of the total sluice stream. The use of slip stream softening in a dewatering bin system would create an additional solid waste stream as well as an additional water loss source which would require more makeup water. Slip stream softening in a dewatering/hydrobin system is not a proven technology based on data from the 308 survey.

Bottom ash obtained from dewatering bins is considered "commercially dry" by vendors of this equipment (36, 39), i.e., on the order of 20 percent moisture. This degree of moisture can vary widely depending on the installation as well as within a particular plant. The ash is wet enough for transport to a landfill site in an open truck without creating a fugitive dust problem, and at the landfill site, there is no need to wet the ash down. Some dust problems may occur with certain western coal ashes since these tend to contain relatively more fines than eastern coal ashes (39).

A dewatering/hydrobin system which contains a slip stream softening system produces a sludge waste stream which requires disposal. This waste is produced at a much lower rate than is the bottom ash and has a higher moisture content.

**Ponding System.** Approximately 81 percent of all plants which replied in the 308 survey designated ponding as their bottom ash handling method. Of these, approximately 9 percent designated either complete or partial recycle.

A ponding recycle system for bottom ash is illustrated in figure VII-41. The ash or slag collected in the bottom ash hopper which is filled with water is ground down to a sluiceable size range by clinker grinders at the bottom of the hopper. Depending on the size of the boiler, the bottom ash hopper may have two or three "pantlegs," or discharge points. At each pantleg there may be one or two clinker grinders. Larger facilities usually have three pantlegs and two clinker grinders at each pantleg (39). Smaller facilities have two pantlegs and one clinker grinder at each leg. Double roll clinker grinders can generally handle from 75 to 150 tons per hour of ash with drives from 5 hp to 25 hp depending on the material to be crushed and required system capacity. A smaller grinder that can handle 20 tons per hour or less uses a single roll with a stationary breaker plate.

After being crushed, the ash is fed into an adopter or sump from which it is pumped by one of two types of pumping devices, a centrifugal pump or a jet pump. Pumps and piping have already been discussed in the subsection on partial recirculating fly ash systems.

A series of ponds are usually used for bottom ash settling. A primary pond accumulates most of the sluiced bottom ash. The sluice water then flows by gravity to a secondary settling pond. Overflow from the secondary pond goes to a final or clear pond which is used as a holding basin for the recirculating water. Pond sizes cover a wide range depending on the plant size, the amount of bottom ash produced (boiler type), pond depth, required holding time (which is a function of the solids settling rate), and the amount of land available. Typically the primary and

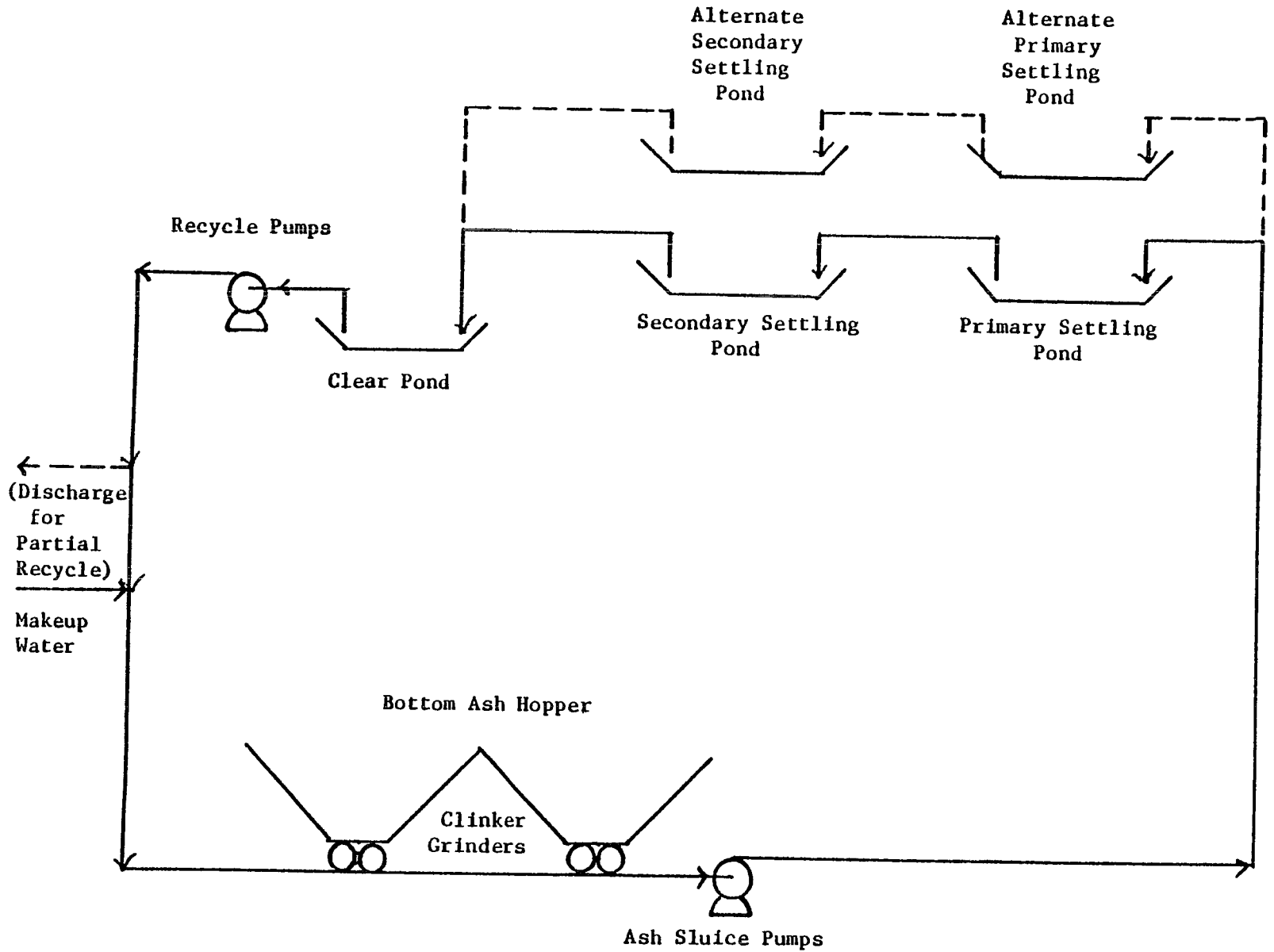

Figure VII-41  
PONDING RECYCLE SYSTEM FOR BOTTOM ASH

secondary ponds are dual systems so that dredging does not interfere with operation. For instance, a plant may have two primary and secondary ponds. One primary and one secondary are dredged annually to remove the settled solids while the other two ponds are in operation.

Facilities may be made available to provide for a discharge of sluice water from the recycle line. A makeup water stream will be necessary due to water losses inherent in the system. The most significant water losses occur in percolation through the floor of unlined ponds and evaporation of pond water. A pond system maintained at a steady-state water balance without discharging is considered a zero discharge or complete recycle system. A partial recycle system maintains a discharge either on a continuous basis or for upset conditions.

Bottom ash recovered from ponds by dredging does not create fugitive dust problems because of the high moisture content of the ash. Disposal of bottom ash may be achieved by any of the conventional landfill methods discussed in the fly ash subsection.

Evaporation Ponds. In cases where pH adjustment can not adequately prevent scale, an alternative to slip stream softening is the release of some of the ash sluice water as a blowdown stream. In cases where it is difficult to maintain a steady water balance in a complete recycle system, occasional discharge of ash sluice water may be necessary. The use of evaporation ponds to contain blowdown streams from dewatering bin systems is an option for achieving zero discharge under these conditions. This option has been successfully exercised in the western part of the United States where high net evaporation rates are indigenous. Two of the plants visited attained zero discharge by using a blowdown to evaporation ponds from dewatering bin systems.

Retrofitting. The primary reasons for retrofitting complete recycle systems are:

- o A shortage of water requiring minimal consumption,
- o State or local regulations governing a reduction in wastewater pollutants, and
- o A market for dewatered slag.

Some of the piping from the old system is reusable in the retrofitted system, although difficulties may be encountered in rerouting old pipe. Of course, difficulty may be encountered in integrating any other system discharge with the bottom ash

recycle loop, e.g., sump discharge and cooling tower blowdown. Plant downtime would be required for the hook-up of the retrofitted dewatering bin system, resulting in a temporary reduction in generating capacity. In addition, some downtime may occur during the debugging period. For some plants, debugging may last up to a year. The land required to retrofit a dewatering bin system is:

- o Approximately 1 acre to contain the dewatering bins, settling tank, surge tank, and pump houses; and
- o Landfill area for bottom ash disposal.

A plant that used a pond system prior to the retrofit of the dewatering bin system probably would have land available for disposal of the dewatered bottom ash.

Utilization of Complete Recycle Systems. Data from the 308 survey provided a list of plants which reported wet recirculating bottom ash handling systems and zero discharge of ash transport water. EPA telephoned each of these 14 plants to confirm the data submitted on the 1976 data form. The results of the telephone contacts appear in table VII-25. Specific details of plant designs are discussed below.

This information has not been positively confirmed for all 14 plants. The only method of positive confirmation is site inspection but time and budget constraints precluded visitation of all 14 plants. Four of the the most likely plants were visited.

Plants 4813, 3203, 1811 and 0822, handle and dispose of bottom ash completely separately from fly ash. The plants employ dry fly ash handling and complete recirculation of bottom ash transport water. The plants are located in Texas, Indiana, Nevada, and Colorado. The facilities in Nevada and Colorado make use of high evaporation rates in those locations to achieve zero discharge while allowing for some blowdown from the systems. The fuels burned at these plants include lignite and bituminous coals with the ash contents ranging from 9.7 percent to 11.5 percent. The boiler types include both pulverized coal boilers and cyclone boilers, giving a bottom ash to fly ash ratio from 20:80 to 90:10. These plants represent zero discharge designs; while the absolute number of plants identified as achieving zero discharge from this study is small, they do present a representative mix of location fuel type and boiler type.

Plants 4813, 3203, and 0822 use hydrobins or dewatering bins to separate the bottom ash particles from the sluice water. In each case, the sluice water overflows the weir at the top of the bin

Table VII-25

DATA SUMMARY OF PLANTS REPORTING ZERO DISCHARGE OF  
BOTTOM ASH TRANSPORT WATER

<u>Plant Code</u>	<u>Location</u>	<u>Fuel</u>	<u>Boiler Type</u>	<u>Ash Handling Systems</u>	<u>Comments</u>
2903	Missouri	Bituminous (13.8% ash)	Pulverized- Dry Bottom	- Fly Ash can be either dry transported to silo (for sale) or or sluiced to pond - Bottom Ash is sluiced to pond and water is recycled	Not all sluice water is recycled some is discharged to a river
2705	Minnesota	Subbituminous (9% ash)	Pulverized- Dry Bottom	- Fly Ash removed in wet scrubber - Bottom Ash is sluiced to pond and some of sluice water is recycled	The Bottom Ash Sluice water not recycled serves as scrubber makeup
2413	Maryland	Bituminous (14.6% ash)	Pulverized- Dry Bottom	- Dry Fly ash handling - Bottom ash sluiced to hydrobins overflow to surge tank and recycled	Not all the sluice water is recycled some reaches central treatment plant
4813	Texas	Lignite (10.4% ash)	Pulverized- Dry Bottom	- Dry Fly ash handling - Bottom ash sluiced either to hydrobins or primary settling ponds all sluice water is recycled	Zero discharge of bottom ash sluice water

Table VII-25 (Continued)

DATA SUMMARY OF PLANTS REPORTING ZERO DISCHARGE OF  
BOTTOM ASH TRANSPORT WATER

<u>Plant Code</u>	<u>Location</u>	<u>Fuel</u>	<u>Boiler Type</u>	<u>Ash Handling Systems</u>	<u>Comments</u>
5102	Virginia	Bituminous (17.8% ash)	Pulverized- Dry Bottom	- Dry Fly ash handling - Bottom ash is sluiced to a pond and all pond water is recycled	Drains carrying discharges from ash hoppers and pumps go to central treatment facility and are discharged
4229	Pennsylvania	Bituminous (11.5% ash)	Pulverized- Dry Bottom	- Dry Fly ash handling - Bottom ash is sluiced to a pond some of the water is recycled	Not a zero discharge facility
4230	Pennsylvania	Bituminous (10% ash)	Pulverized- Dry Bottom	- Wet Fly ash handling with recirculation of water - Bottom ash sluiced to a pond, some of the water is recycled	Not a zero discharge system facility, ash transport water goes to treatment facility
2901	Missouri	Subbituminous (25% ash)	Pulverized- Wet Bottom	- Fly ash is sluiced to settling pond water is recycled - Bottom ash is sluiced to settling pond and water is recycled	Combined ash pond, all water is recycled-zero discharge of ash transport water

Table VII-25 (Continued)

DATA SUMMARY OF PLANTS REPORTING ZERO DISCHARGE OF  
BOTTOM ASH TRANSPORT WATER

<u>Plant Code</u>	<u>Location</u>	<u>Fuel</u>	<u>Boiler Type</u>	<u>Ash Handling Systems</u>	<u>Comments</u>
3203	Nevada	Bituminous (9.69% ash)	Pulverized- Dry Bottom	- Dry Fly ash handling - Bottom ash is sluiced to dewatering bins and water is recycled	Blowdown from bottom ash sluicing system goes to evap. ponds
1811	Indiana	Bituminous (11.54% ash)	Cyclone- Wet Bottom	- Dry Fly ash handling - Bottom ash is sluiced to a pond, water is recycled recycled	Zero discharge design however blowdown is removed at times when water balance problems occur
1809	Indiana	Bituminous (13.72% ash)	Cyclone- Wet Bottom	- Fly ash is wet sluiced to ponds overflow goes to recycle - Bottom ash is wet sluiced to holding pond overflow to recycle	Recycle serves both fly ash and bottom ash sluicing opera- tions, zero dis- charges except under upset conditions
3626	New York	Bituminous (17.7% ash)	Pulverized- Dry Bottom	- Dry Fly ash handling - Bottom ash wet sluiced to hydrobins, overflow to surge tank and recycled	Some water is discharged due to water balance problems



Table VII-25 (Continued)

DATA SUMMARY OF PLANTS REPORTING ZERO DISCHARGE OF  
BOTTOM ASH TRANSPORT WATER

<u>Plant Code</u>	<u>Location</u>	<u>Fuel</u>	<u>Boiler Type</u>	<u>Ash Handling Systems</u>	<u>Comments</u>
2415	Maryland	Bituminous (14.58% ash)	Pulverized- Dry Bottom	- Dry Fly ash handling - Bottom ash wet sluiced some of water is recycled	Not a zero dis- charge plant, sluiced water is treated prior to discharge
0822	Colorado	Bituminous (10.66% ash)	Pulverized- Dry Bottom	- Dry Fly ash handling - Bottom ash is wet sluiced to hydrobins and overflow goes to recycle basin	Blowdown from sluice system is sent to evapora- tion pond

and gravity flows to a surge tank which supplies the suction side of the recycle or recirculation pumps. Makeup water to compensate for evaporation, water lost from pump seals, water lost from the ash hopper locks, water occluded with the bottom ash and other spills and leaks is added at some point in each system depending on the plant. Accurate control of makeup water is an important factor in achieving zero discharge. If the actual makeup rate exceeds the required makeup rate, a system upset occurs which causes discharge of ash transport water. Such upsets do occur in most systems from time to time, but do not constitute normal operating procedure. Plant 0153 has settling ponds backing up the hydrobins. Bottom ash can be sent to either system. One pond serves as a recycle tank from which recirculating sluice water is drawn.

Plant 1811 uses a ponding system to separate the bottom ash from the sluice water. One side of the settling pond is wide and gradually inclined. The ash is sluiced to this open area where the heavy material forms a pile. The sluice water drains into a final settling pond at the base of the incline. The recirculation pumps draw suction from this pond. All system drains and leaks are sent to this pond.

Plants 2901 and 1809 sluice both fly ash and bottom ash. These two sluice waters are ponded prior to recycle. In both cases, the primary settling ponds for fly ash and bottom ash are separate ponds. The overflow from these ponds gravity flows to a final settling pond. Both plants are zero discharge designs. Only under upset conditions is ash handling water discharged. The plants are located in Missouri and Indiana and burn a subbituminous coal with 25 percent ash and a bituminous coal with 13.7 percent ash. Both plants have cyclone boilers which give a bottom ash to fly ash ratio of 90:10.

The remaining plants employ some continuous blowdown or discharge from the recirculating bottom ash sluicing systems. These plants have very low discharge rates but are not zero discharge facilities. Only one plant, 4429, was designed to be zero discharge but was unable to close the water balance due to problems in accurately monitoring the makeup water requirement. An additional plant, 2750, was not intended to be a closed-loop bottom ash system since the scrubber makeup is drawn from the recycle tank. If the scrubber loop can be operated in a closed-loop or zero discharge mode, this plant could be considered a zero discharge facility from the standpoint of ash handling. It could not, however, be representative of achievable complete recycle technology for bottom ash handling.

Each plant contact was asked if any scaling or corrosion problems had resulted from the recirculation mode of operations. Only one

plant, 2750, indicated that scaling in the recirculation line might be a problem. No such problems have been encountered however. The plants in the survey produce both alkaline ash and acid ash covering the range of chemical properties of ash handling waters.

Trip Reports. Four plants were visited to confirm the bottom ash handling practices as zero discharge. Only two of the four plants were true zero discharge plants: 3203 and 0822. In both cases a blowdown from the bottom ash sluicing systems (with dewatering bins) was observed; however, this blowdown was directed to evaporation ponds on plant property. The purpose of the blowdown was primarily to maintain a steady-state water balance. The remaining two plants, 1811 and 1809, were confirmed as having discharges and were considered partial recycle plants.

Abridged versions of the trip reports for these plants are contained in this subsection. A description of the bottom ash handling system, a discussion of retrofitting problems, a discussion of operating and maintenance problems, and a presentation of sampling and analysis work are provided for each plant. Detailed information concerning the analytical techniques is presented in Appendix D.

Plant 3203. This plant is a 340-MW western bituminous coal-burning facility that uses a dewatering bin (United Conveyor Corporation) bottom ash sluice recycle system with a series of evaporation ponds. The plant fires a moderately low-sulfur coal (average 0.6 percent) with an average ash content of 12 percent and fluctuation to approximately 16 percent ash. The availability of the three boilers has historically averaged 86 percent annually. Water comes from two sources. During the summer, water is pumped from wells and during the winter, from a nearby river. The water is pumped to a reservoir for holding and then to the three cooling towers. Blowdown from the cooling towers accumulates in a storage tank. Water from this storage tank then feeds the three SO<sub>2</sub> scrubbers as well as the bottom ash sluicing system. The bottom ash storage tank receives water from the cooling tower blowdown storage tank and from the plant drain sump; the drain sump receives water from the area drains and boiler blowdown. A generalized flow diagram appears in figure VII-42, which shows the major equipment and associated typical flow rates.

The bottom ash sluicing system was designed and installed by United Conveyor Corporation. It was retrofitted to Units 1 and 2 and was installed along with Unit 3. The system was designed for 7 percent ash coal with capacity to handle a fourth unit, which was to be built at a later date. The bottom ash handling system is currently operating at a greater-than-rated capacity due to

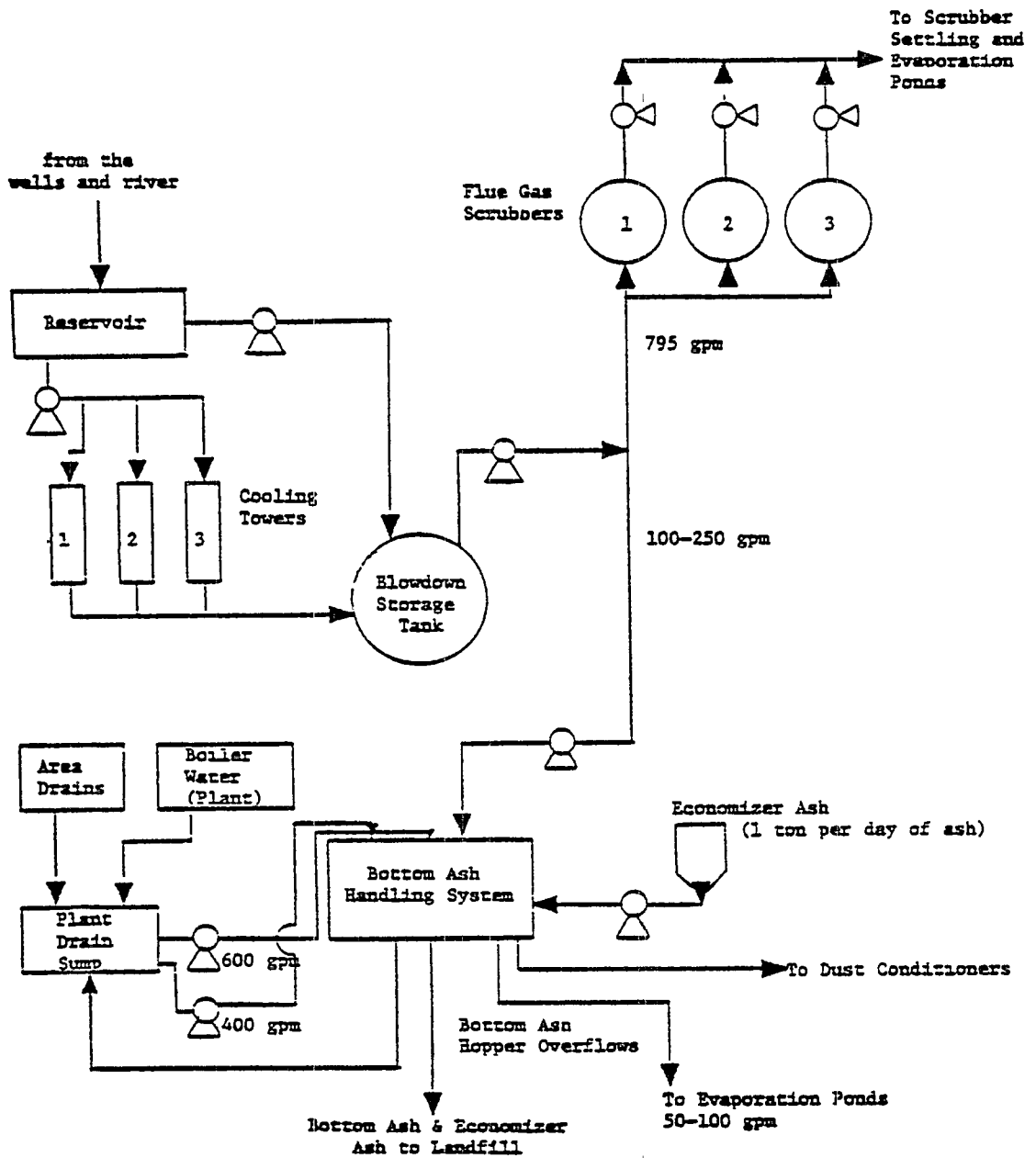

Figure VII-42  
 WATER FLOW DIAGRAM FOR PLANT 3203

the higher-than-average ash coal being burned in the three units. The general flow scheme for this bottom ash recycle system is shown in figure VII-43. The bottom ash handling system processes approximately 77 tons per day of bottom ash as well as 1 ton per day of economizer ash for all three units combined. The bottom ash is pumped from the hoppers to the dewatering bins for approximately 4 hours per day, the economizer ash for 1 hour each day. It takes approximately 6 hours to dewater the bottom ash in the bin to yield an ash moisture content of about 20 percent to 50 percent. Approximately one truckload of dewatered bottom ash is hauled to the onsite disposal area per day. The number of loads per month varies from 30 to 40. The disposal area is 1 mile from the plant. The hauling and placement of the ash is contracted to an outside firm.

The major equipment for the bottom ash recycle system was bought from and installed by United Conveyor Corporation. The dewatering bins are 30 feet in diameter, with 5,000 cubic feet per bin. Two bins are used: one dewateres ash, while the other fills with ash. The drained-off water from the bins flows by gravity to a settling tank of 50 feet in diameter and a capacity of 145,000 gallons. Sludge pumps are provided beneath the settling tank to pump any settled solids back into the top of the settling tank. Overflow from the settling tank drains into the surge (or storage) tank, which is of the same diameter and capacity as the settling tank. The surge tank is operated, however, at 19,108 cubic feet, or 135,000 gallons. Sludge pumps beneath the surge tank pump any settled solids back into the settling tank. From the surge tank, water is pumped back to the bottom ash hoppers for subsequent sluicing. A jet pump provides the pressure for transporting the ash to the dewatering bins. The length of pipe from the bottom ash hopper to the dewatering bin is approximately 500 feet for Unit 3 and 100 feet from Units 1 and 2. The pipe diameter for this system is typically 10 inches with a discharge pressure of 200 psi. The land area devoted to the dewatering bins, settling tank, and surge tank is approximately one acre; this does not include the pump house or pipe rack. The bottom ash is trucked to a 200-acre, onsite landfill area. Side streams are taken from the bottom ash sluice lines which feed the fly ash dust conditioning nozzles and from a purge stream to the evaporator ponds. The purge flow rate is continuous and varies from approximately 50 to 100 gpm.

The maintenance of the sluicing system has been nominal since installation in 1975. No chemical testing for scaling species has been done and no scaling has been observed to the extent of producing a malfunction in equipment or line pluggage. Some minor corrosion on valves has occurred and some pump repair has been needed due to minor erosion.

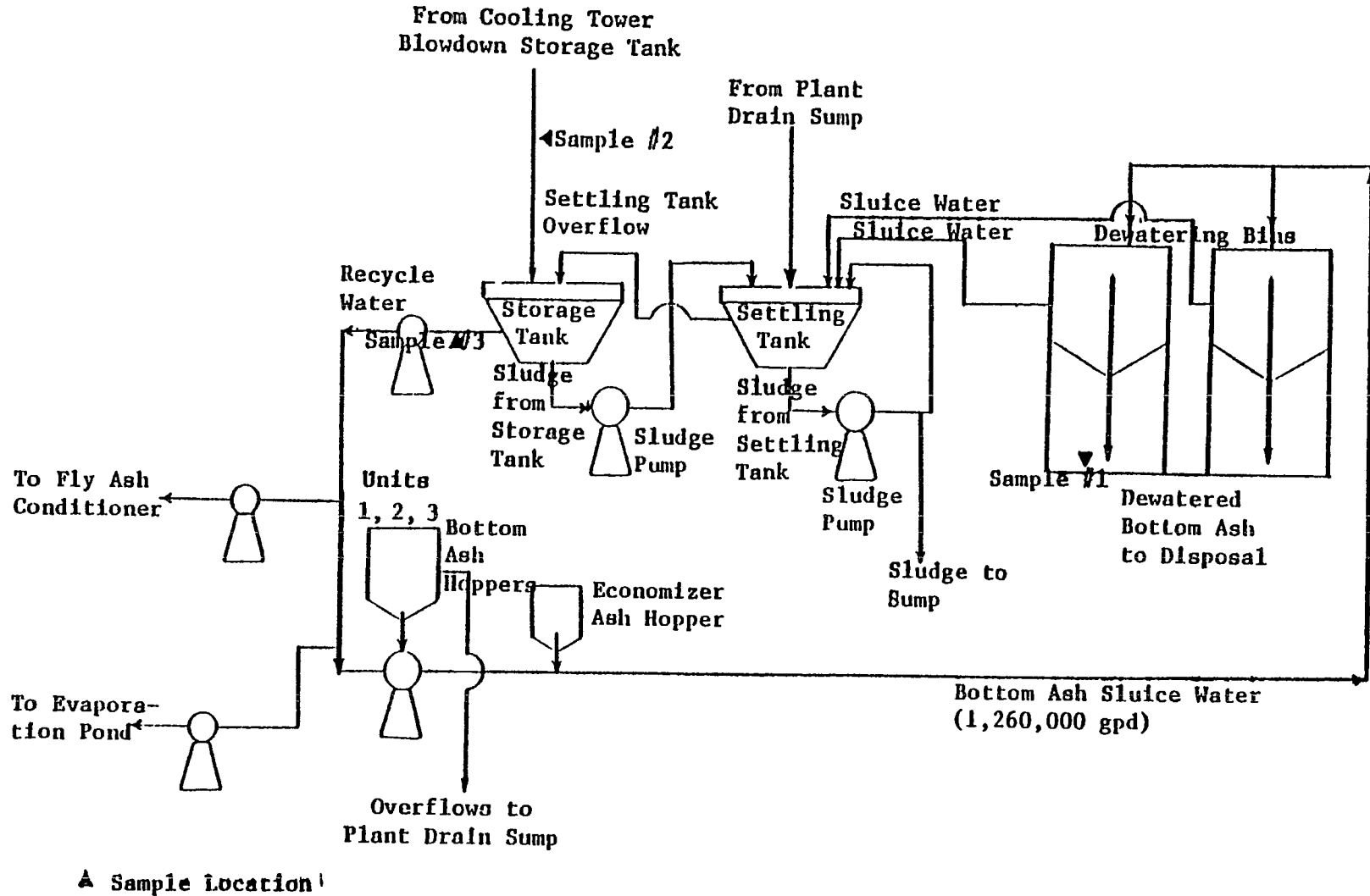

Figure VII-43  
 BOTTOM ASH RECYCLE SYSTEM AT PLANT 3203

There is a problem with solids pluggage in the bottom of the settling tank. This is due to several inherent design aspects of the system. The settling tank is not designed to remove large amounts of sludge. In this system, the plant drain sump discharges to the settling tank as well as the sludge from the surge tank. Adding to the problem is the fact that the system was designed to remove less ash than is currently being generated. Generation of fines is indigenous to western bituminous coal ash. These fines can plug the dewatering bin screens and overflow into the settling tank. A platform has been built over the settling tank to provide access for air lancing the solids in order to prevent sludge pump plugging. The settling tank sludge pumping capacity is to be doubled in the future to help reduce the load on the current pumps.

The entire bottom ash system requires two men per day for maintenance and one man per shift each day for operation of the system.

The motivation for retrofitting the bottom ash recycle system was a general water shortage problem associated with both wet once-through bottom ash and fly ash handling systems. At the time the bottom ash recycle system was installed, a pressure dry fly ash handling system and a third unit were also installed. Scaling problems tended to be more prevalent in the wet once-through system than in the current bottom ash sluice recycle system. Some of the wet once-through system piping was reused in the installation of the new bottom ash system. A 2-week outage for Units 1 and 2 occurred when the retrofit systems were installed and major pipe rerouting was done. It took approximately a year to debug the fly ash and bottom ash systems as well as the new Unit 3.

Samples were taken at three different locations in the bottom ash sluicing system. These locations are shown in the bottom ash sluicing system diagram in figure VII-43 and are described as follows:

- o A sample was taken of a stream of water leaking through the slide gate at the bottom of the dewatering bins,
- o A sample was taken of the recycle system makeup water from the cooling tower blowdown tank, and
- o A sample was taken at the recirculation pump which pumps the ash transport water back to the bottom ash hoppers.

These samples provide an indication of the trace elements, major species, and carbon dioxide content of transport streams before and after dewatering of the bottom ash and of the makeup water to the system. The trace elements which were quantified include

silver, arsenic, beryllium, cadmium, chromium, copper, mercury, nickel, lead, antimony, selenium, thallium, and zinc. Other metal elements (major species) were magnesium, calcium, and sodium. The non-metal major species quantified were phosphate, sulfate, chloride, silicate, and carbon dioxide. The results of the analyses are presented in tables VII-26 and VII-27.

Of the three samples taken, the cooling tower blowdown had the highest concentrations in arsenic, magnesium, sulfates, and silicates. The pH of this stream was 8.2, and the temperature was 96°F. Dilution of this stream in the surge tank with the plant drain sump effluent resulted in lower concentrations of these species. Species which had the highest concentrations at the recirculation pump, i.e., downstream from the surge tank, were phosphates, chlorides, carbon dioxide, zinc, and sodium. The pH of this stream was 8.2, and the temperature was 126°F. The third sample was taken from a leak beneath the dewatering bin during an ash dewatering mode of operation. The pH of this water was 10.4, and the temperature was ambient, 106°F. The significant species in this sample relative to the other two samples were copper, lead, and calcium.

On the basis of the sampling results and the subsequent analyses, EPA assessed the potential for precipitation of certain species by using an aqueous equilibrium computer program. The results from this assessment indicated that the calcium carbonate species has the greatest potential for precipitation in the leakage from the dewatering bin sample. The next greatest potential for the same species was in the cooling tower blowdown. The lowest potential was in the recycle stream prior to the recirculation pump. In this case, the maximum precipitation potential occurred in the stream in contact with the coal ash for the greatest period of time.

In conclusion, a closed-loop bottom ash system is feasible at Plant 7281 by using discharge to evaporation pond. The technical problems associated with the equipment in the closed-loop system were of a reconciliable design nature. The only significant equipment problem exists because the settling tank was designed to handle all the overflow fines from the dewatering bins. More modern systems pipe these overflow fines back to dewatering bins. Chemically, there seemed to be no major cycling of trace elements and major species concentrations as a result of the closed-loop operation. It appears, however, that the concentration of copper increases as a consequence of sludge water being in contact with the coal ash. Contact with the coal ash also increased the concentrations of calcium and sodium. The potential for precipitation of  $\text{CaCO}_3$  exists in all three sample streams based on scaling tendency calculations. The greatest potential exists in the sludge water in the dewatering bin. This means that



Table VII-26

TRACE ELEMENTS/PRIORITY POLLUTANTS<sup>1</sup>  
CONCENTRATIONS AT PLANT 3203

(ug/l)

	<u>Cooling Tower Blowdown</u>	<u>Leakage from Dewatering Bin</u>	<u>Recirculation Pump</u>
pH	8.20	10.40	8.20
Temp. (°F)	96	--	96
Silver	<0.1	<0.1	<0.1
Arsenic	71	4	26
Beryllium	<0.5 <sup>2</sup>	<0.5	<0.5
Cadmium	<0.5	<0.5	<0.5
Chromium	15	24	19
Copper	21	49	5
Mercury	<2	<2	<2
Nickel	<0.5	<0.5	<0.5
Lead	<3	4	<3
Antimony	8	<1	5
Selenium	5	<2	<2
Thallium	<1	<1	<1
Zinc	160	40	40

<sup>1</sup>Two analyses were done for each sample species, the results are given as the average for each element.

<sup>2</sup><.5 refers to the fact that the measured concentration was less than 0.5 g/l, which is the detection limit for this species.

NOTE. All concentrations reflect dissolved as opposed to total concentrations.

Table VII-27  
 MAJOR SPECIES CONCENTRATION<sup>1</sup> AT PLANT 3203

(mg/l)

	<u>Cooling Tower Blowdown</u>	<u>Leakage from Dewatering Bin</u>	<u>Recirculation Pump</u>
Calcium	395	505	310
Magnesium	190	1	105
Sodium	645	780	770
Phosphate <sup>2</sup>	0.40	0.06	2.30
Sulfate	2546	1773	1786
Chloride	394	601	622
Silicate	181	27	92
Carbonate	2520	60	2760

---

<sup>1</sup>Two analyses were done for each sample for Ca, Mg, Na, the results are given as an average of the two values.

<sup>2</sup>All species except Ca, Mg, Na, were analyzed only once, one number is reported for each sample species.

NOTE: All concentrations reflect dissolved as opposed to total concentrations.

increased recycle or continuous operation of the current system can cause scale formation on pipes thereby reducing the flow rate in the pipes.

Plant 0822. This plant is a 447 MW coal-fired powerplant located in northwestern Colorado. The plant consists of two units: Unit 1 completed in 1965 and Unit 2 in 1976. The facility is a base-load plant using cooling towers for condenser heat dissipation, dry fly ash transport, and a zero discharge bottom ash sluicing system. The plant burns a bituminous coal from USBM Coal District 17. The plant is sufficiently close to the coal mine (nine miles) to be considered a mine-mouth operation. Plant water is drawn from a nearby river. The facility utilizes an RCC vapor compression distillation unit to recover recycleable water from cooling tower blowdown. All final wastewaters are ultimately handled by an evaporation pond. A general description along with a flow diagram (figure VII-23) of this plant has been provided in the fly ash subsection.

The flow scheme for the bottom ash sluice system is illustrated in figure VII-44. Bottom ash from the boiler is jetted to one of two United Conveyor dewatering bins (one bin is in operation while the other is being drained). The overflow from the dewatering bin flows by gravity to a solids settling tank. Sludge from the settled ash material is pumped back to the hydro-bin. The overflow from the settling tank flows to the surge tank and then to the two centrifugal pumps which supply water to the ash jet pumps. Makeup water, which consists of cooling tower blowdown and some plant raw water, is added to two ash water storage tanks. The makeup water is directed either to the surge tank or to the high- and low-pressure ash water pump suction headers. Under normal operation, the ash water makeup equals the water retained by the bottom ash after dewatering, the water used for wetting fly ash prior to unloading and small losses from evaporation in the bottom ash hopper. Any solids which settle to the bottom of the surge tank are pumped as sludge back to the dewatering bins.

Once the dewatering bin fills with bottom ash, the bottom ash sluice is switched to the other bin. The filled bin is then drained of the sluice water. When the bottom ash is sufficiently dewatered (after about 8 hours), it is dumped into an open truck and hauled to the mine for disposal. The sluice water makeup from the cooling tower blowdown is treated with a scale inhibitor (NALCO). The cooling towers operate between 8 and 10 cycles of concentration with a dissolved solids level of 1,200 mg/l.

The current bottom ash sluice system was designed as a part of Unit 2. Thus, for Unit 2, the system is an original design while for Unit 1, it is a retrofit. Prior to the construction of the

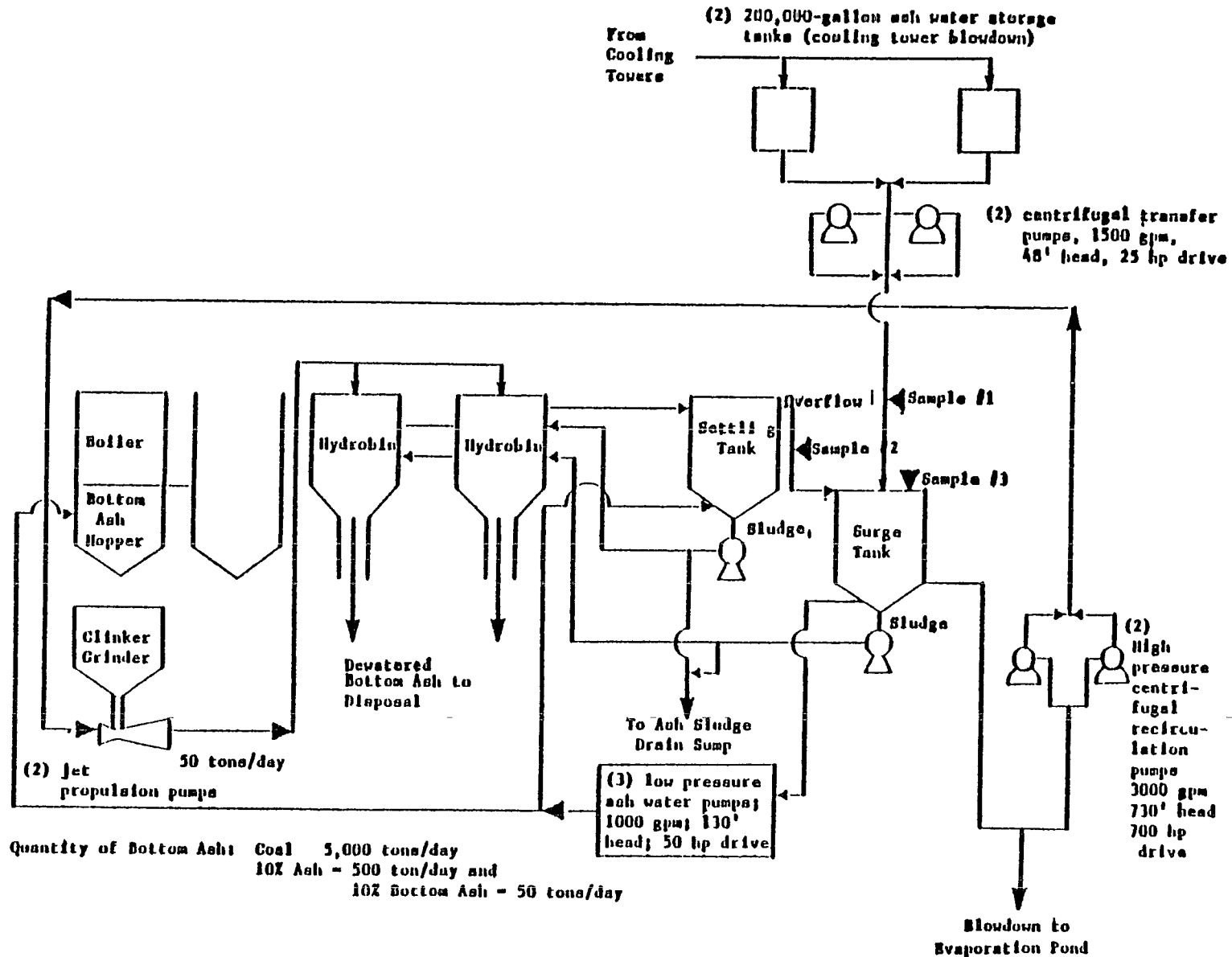

▼ Sample

Figure VII-44  
 BOTTOM ASH HANDLING SYSTEM FOR PLANT 0822

current system in 1975, the plant used a once-through sluice operation in which both fly ash and bottom ash were sluiced to a pond. The solids resulting from these operations have since been removed and disposed of at the mine. The pond now serves as a water storage pond to be used in the event of drought conditions.

The bottom ash handling system supplier for plant 0822 is United Conveyor Corporation. The following discussion provides specific information concerning the major equipment for the bottom ash handling system.

Two ash water storage tanks hold the makeup water to the ash handling system. These tanks have volumes of 200,000 gallons each. High and low water level switches are used to control the water level in these tanks.

Two Bingham horizontal end suction, back pullout, centrifugal pumps each rated at 150 gpm, 48 feet head are driven by 25 HP, 1,200 rpm Westinghouse motors. These pumps supply water to the surge tank from the ash water storage tanks and are automatically controlled by surge tank hi-low level switches.

Two high pressure pumps supply recirculation water to the jet pumps at the bottom ash hoppers from the surge tank. These pumps are Bingham horizontal, single stage, axially split, double suction centrifugal pumps each rated at 3,000 gpm, 730 feet head and are driven by 700 hp, 3,600 rpm Reliance motors. Start-stop control switches are located on the bottom ash panel.

Three low pressure ash water pumps supply ash water from the surge tank at a pressure of approximately 50 psig to the surge and settling tanks for sludge removal and flushing, and to the bottom ash hopper for fill, seals, flushing, and overflow supply. These pumps are Bingham horizontal end suction, back pullout, single stage centrifugal pumps each rated at 1,000 gpm, 130 feet head and are driven by 50 hp, 1,800 rpm Westinghouse motors. Automatic controls are located on the bottom ash panel and manual controls are locally placed.

The "jetpulsion" pumps are jet pumps located beneath the cylinder grinders. These pumps create the force necessary to convey the ash and water to the dewatering bins. Water for the "jetpulsion" pumps is supplied by the high pressure ash water pumps. These jet pumps are controlled on and off by associated two-way rotary sluice gates located in the discharge line of each pump. The sluice gates are solenoid operated from the bottom ash control panel by OPEN-CLOSE switches.

Each of the two dewatering bins is designed to provide a net storage volume of 12,700 cubic feet or approximately 48 hours

bottom ash storage capacity with both Unit 1 and 2 at full load. Also, each bin is fitted with a 12 kw chromolox electric heater and an ash level detector which activates an alarm and a light on the control room panel when maximum ash level is reached. At this point the conveyor is stopped, the diverting gates are switched, and the conveying operation is then restarted by an operator.

Separate settling and water surge tanks are provided to recover the ash water used in the handling of bottom ash and pyrites. The settling tank is sized to provide flow-through water velocities sufficiently low to precipitate most particulate matter larger than 100 microns. Sufficient volume is provided in the surge tank to absorb the severe imbalance between input and output flows that occur when the system progresses through the ash transport and dewatering cycle.

The manpower increase due to the retrofitted ash handling systems is 15. This number includes both fly ash and bottom ash systems for both maintenance and operation.

The maintenance problems with the bottom ash handling system are nominal. The most frequently recurring problem is the erosion of the impellers and casings of the high pressure recirculation pumps. There are no problems with fines in the operation of the dewatering bins, e.g., screen plugging or overflow into the settling tank causing plugging of the sludge pumps. Some problems arose in retrofitting the bottom ash system; the usual pipe rerouting, use of old pipe, and outage time were required for the system installation.

Samples were taken at three different locations in the bottom ash sluicing system. These locations were:

- o A sample was taken of the system makeup stream from the cooling tower blowdown water,
- o A sample was taken of the settling tank overflow to the surge tank, and
- o A sample was taken from the surge tank.

These samples provide an indication of the trace elements, major species, and carbon dioxide content of transport streams before and after the surge tank, and of makeup water to the system. The trace elements which were analysed include silver, arsenic, beryllium, cadmium, chromium, copper, mercury, nickel, lead, antimony, selenium, thallium, and zinc. The major species analyzed were magnesium, calcium, sodium, phosphate, sulfate, chloride, silicate, and carbon dioxide. The results of these analyses are reported in tables VII-28 and VII-29.

Table VII-28

TRACE ELEMENTS PRIORITY POLLUTANTS CONCENTRATIONS<sup>1,2</sup>  
AT PLANT 0822

(ug/l)

	<u>Cooling Tower Blowdown</u>	<u>Settling Tank Overflow</u>	<u>Surge Tank</u>
pH	8.0	6.3	6.7
Temp. (°F)	89.0	130.0	126.0
Silver	<0.1	0.4	<0.1
Arsenic	49.0	3.0	3.0
Beryllium	<0.5 <sup>3</sup>	<0.5	<0.5
Cadmium	<0.5	2.0	<0.5
Chromium	<2.0	10.0	<2.0
Copper	47.0	8.0	15.0
Mercury	<0.2	<0.2	<0.2
Nickel	<0.5	<0.5	<0.5
Lead	<3.0	<3.0	<3.0
Antimony	<1.0	<1.0	5.0
Selenium	<2.0	5.0	6.0
Thallium	<1.0	<1.0	<1.0
Zinc	95	145	410

<sup>1</sup>All trace element analyses were done in duplicate, the two values were averaged.

<sup>2</sup>All concentrations are for the dissolved, not total, concentration.

<sup>3</sup>The value <0.5 indicates that the concentration was below the detection limit which in this case is 0.5 ppb for beryllium.

Table VII-29  
 MAJOR SPECIES CONCENTRATIONS<sup>1,2</sup>  
 AT PLANT 0822

(mg/l)

	<u>Cooling Tower Blowdown</u>	<u>Settling Tank Overflow</u>	<u>Surge Tank</u>
Calcium	365	365	370
Magnesium	120	92	90
Sodium	210	145	150
Phosphate (PO <sub>4</sub> )	3.3	0.17	0.09
Sulfate (SO <sub>4</sub> )	1215	1203	1165
Chloride (Cl <sup>-</sup> )	211	112	125
Silicate (SiO <sub>2</sub> )	57	36	35
Carbonate (CO <sub>3</sub> <sup>=</sup> )	60	120	360

<sup>1</sup>Ca, Mg, Na were analyzed in duplicate, values are averages.

<sup>2</sup>All values reflect dissolved, not total, concentrations.



The sampling results indicate that the contact of the sluice water with the bottom ash, as reflected in the settling tank overflow species values relative to the other two streams, raises the concentrations of some species. The trace elements, which increased due to ash contact are silver, cadmium, chromium, selenium, and zinc. For the major species, an increase in carbonate concentration is reflected in the carbon dioxide values. Decreases in concentration from the makeup source to the recycle loop are observed for arsenic and copper and for magnesium, sodium, chloride, and silicate, which indicates that a cycling effect does not exist in this system for these species.

On the basis of the sampling analyses, the Agency determined the tendencies for scaling for various species in the makeup and recycle streams by using an aqueous equilibrium program. The amount of scaling which may actually exist is contingent upon the amount of the species present and any other inhibitor additives which may be present. Only one sample species represented any driving force for precipitation. This species was  $\text{CaCO}_3$  for the cooling tower blowdown makeup water stream.

In summary, this plant has achieved zero discharge by using evaporation ponds. No significant mechanical problems have occurred since the installation of this bottom ash system in 1974, and no significant problems arose during the retrofitting procedure. Chemically, some increase in trace element priority pollutants and major species concentrations has been observed due to contact with the ash. The potential exists for scaling  $\text{CaCO}_3$  in the makeup water stream. However, neither scaling nor corrosion has been a problem in the operation of this system.

Plant 1811. This plant is a 615-MW electric power generating station located in Northern Indiana. The plant uses a wet recirculating ponding system to handle bottom ash. This ash is generated by two cyclone-type boilers of 194 and 422 MW each. The coal ash content is 10 to 12 percent with 11 percent as the average. This bituminous coal is obtained from Bureau of Mines Coal Districts 10 and 11. The bottom ash sluicing recycle system was retrofitted in the early 1970's. The dry fly ash handling system was retrofitted early in 1979. Both of these systems were designed and installed by United Conveyor Corporation.

The bottom ash sluicing system is characterized by a bottom ash storage area, a series of settling ponds, and a recirculation or final pond. Figure VII-45 presents the sluice system flow diagram for the plant. Only one primary and one secondary pond is used during operation of the sluicing system. The sluice lines shown, other than the bottom ash sluice, are used to transport sump water to the ponds. Also, the discharge from a package sewage treatment facility is sent to the primary settling pond.

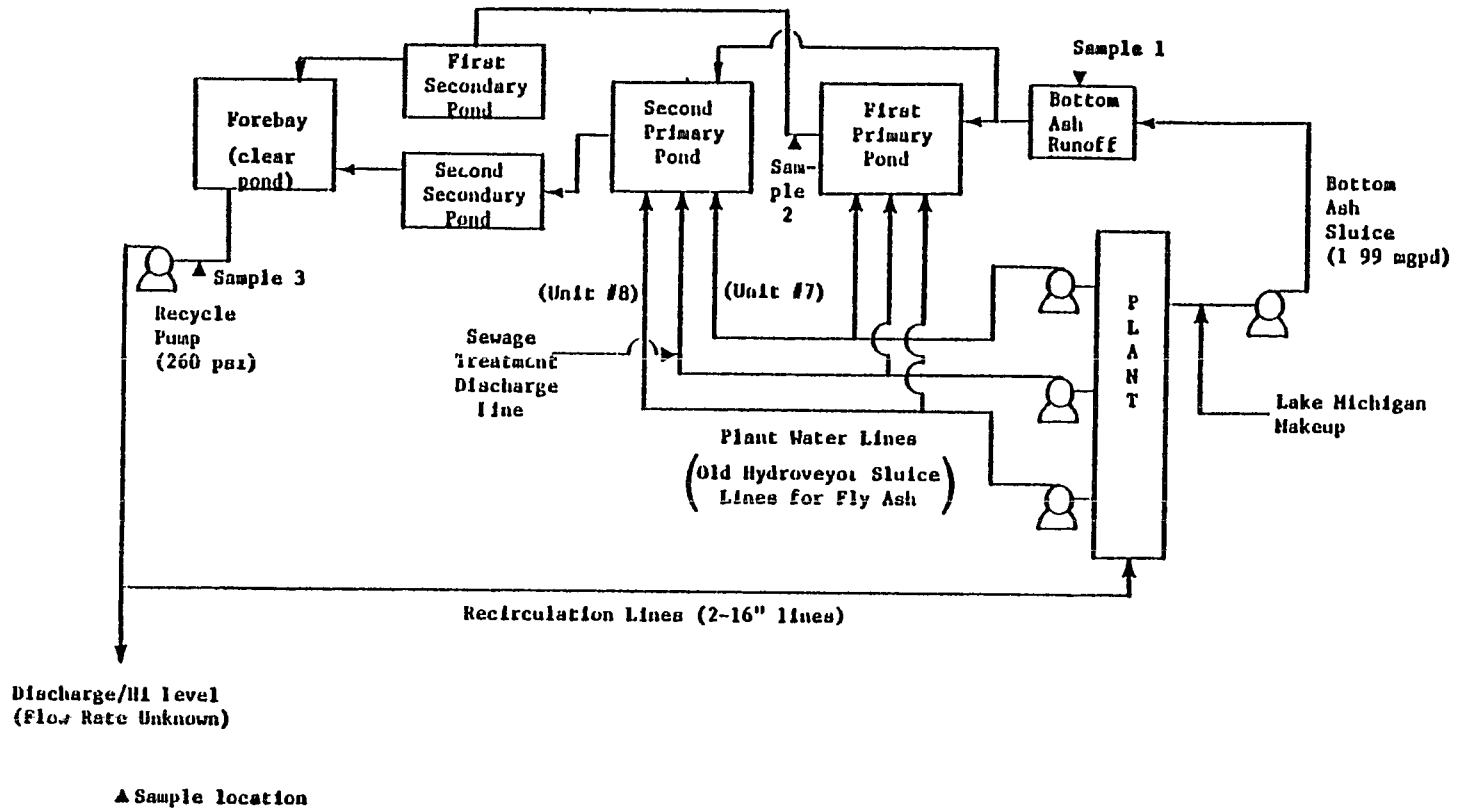

Figure VII-45  
PLANT 1811 FLOW DIAGRAM FOR BOTTOM ASH HANDLING

The hydroveyor line, which was used to sluice fly ash to the ponds, is used as a backup to the normal ash sluice pipes. The main sluice pumps for the bottom ash are jet pumps which discharge at a pressure of 230 psig at the runoff area. The larger unit 8 has two 10 inch sluice lines (including one spare) which transport the ash one-quarter of a mile to the slag runoff area. The smaller unit 7 has one 10 inch sluice line. The flow rate used to transport the bottom ash to the runoff area is approximately  $2.0 \times 10^6$  gpd. The ash is sluiced for 1 to 2 hours each shift (depending on the load) with 10 minutes of flushing before and 15 to 20 minutes afterwards. The surface areas of the two primary settling ponds are 4.2 acres (182,900 feet<sup>2</sup>) and 4.4 acres (192,200 feet<sup>2</sup>). The areas of the two secondary ponds are 2.09 acres and 3.66 acres. The forebay or final pond has an area of 0.1 acres (5,188 feet<sup>2</sup>). Three centrifugal pumps are located at the forebay which are used to recirculate the sluice water back to the bottom ash pump (a distance of 1/2 mile) as well as the general plant water system through one of two existing lines (16 inches diameter). These recirculation pumps supply sluice water to the bottom ash pump at a discharge pressure of 260 psig. A single pipe exists downstream of the forebay recirculation pumps which allows for the discharge of sluice water from the recirculating system. This discharge is initiated during upset conditions but is under complete control of the plant operators. This discharge is estimated to occur 2 days out of 7. The water is transported to Lake Michigan. Since this occurs intermittently, the flow rate was difficult to quantify. Makeup water to the bottom ash sluicing system enters the system at the sluice pumps from Lake Michigan. Makeup water is required because of pond evaporation, pond percolation, and water losses by removal of wet bottom ash. The amount of ash handled by the bottom ash sluicing system was estimated by 1978 FPC figures given by Plant 1811 personnel.

In 1978, the amount of bottom ash collected was 72,200 tons. The operating and maintenance cost associated with the sluicing operation was \$67,300 for 1978. The hauling and disposal of the bottom ash at the landfill site was contracted out and cost \$86,900 in 1978. Some of the bottom ash was sold which yielded \$11,400.

Operating problems associated with the sluice system are nominal. Occasional broken lines and ruptured slag pumps require periodic maintenance, but this is considered normal. One major operating problem is pond sluice water percolation. The ponds are located at a higher elevation than a nearby plant and national park. These ponds are not sealed and the sluice water seeps into off-site water systems. The amount of percolation increases during periods of high water levels in the pond. Future plants are expecting to build a lined pond to prevent this percolation.

The operating manpower required to run the sluicing system is one man part-time in the control room each shift and one man part-time monitoring the slag sluicing operation. This requirement totals to one man full-time for equipment maintenance. Most heavy maintenance work is done during planned outages.

The recycle portion of the sluice system, i.e., the forebay and recycle line, was retrofitted in the early 1970's as a result of a decision to collect all process waters at one location. No problems were incurred due to the retrofit of the system.

Samples were taken at three different locations in the bottom ash sluicing system. These locations, which are designated in figure VII-45, are:

- o the bottom ash discharge point,
- o the primary pond overflow, and
- o the forebay outfall.

These samples were taken to provide an indication of the levels of trace elements and major species in the recirculating/sluicing system. The trace elements assayed were silver, arsenic, beryllium, cadmium, chromium, copper, mercury, nickel, lead, antimony, selenium, thallium, and zinc. The major species assayed were magnesium, calcium, sodium, phosphate, sulfate, chloride, silicate, and carbon dioxide. The results of these analyses are reported in tables VII-30 and VII-31.

The sampling results are inconclusive. Most of the concentrations are low, except for the sulfate and zinc. There is essentially no indication of an effect on trace metal concentrations due to contact of the sluice water with the ash.

On the basis of sampling results, EPA determined the tendencies for scaling for various species in the recycle streams by using an aqueous equilibrium program. The results of this analysis indicated that the potential for scaling of four major species was very low in all three sample streams.

The feasibility of zero discharge using complete recycle with ponding for bottom ash cannot be confirmed by the system used at this plant because it requires intermittent discharge to maintain a steady-state water balance in the system; however there were no mechanical or chemical problems related to the recycle operation. The problem with percolation could be alleviated by lining the existing ponds.

Table VII-30  
TRACE ELEMENTS PRIORITY POLLUTANTS CONCENTRATIONS<sup>1,2</sup>  
AT PLANT 1811

(ug/l)

	<u>Forebay Outfall</u>	<u>Primary Pond Overflow</u>	<u>Bottom Ash Discharge</u>
pH	6.5	6.7	6.3
Temp. (°F)	77	79	85
Silver	<0.1 <sup>3</sup>	<0.1	<0.1
Arsenic	<1.0	2	6
Beryllium	<0.5	<0.5	<0.5
Cadmium	6.0	5.0	8.0
Chromium	<2	<2	<2
Copper	14	3	10
Mercury	<1	<1	<1
Nickel	27	16	17
Lead	<2	<2	<2
Antimony	<3	<3	<3
Selenium	<2	<2	<2
Thallium	10	10	25
Zinc	270	180	90

---

<sup>1</sup>All trace elements analyses were done in duplicate, and the two values were averaged.

<sup>2</sup>All concentrations are for the dissolved, not total, concentration.

<sup>3</sup>The value <.1 indicates that the concentration was below the detection limit which in this case is .1 ppb for silver.

Table VII-31

MAJOR SPECIES POLLUTANTS CONCENTRATIONS<sup>1,2</sup>  
AT PLANT 1811

(mg/l)

	<u>Forebay Outfall</u>	<u>Primary Pond Overflow</u>	<u>Bottom Ash Discharge</u>
Calcium	69	54	74
Magnesium	14	11	19
Sodium	40	43	36
Phosphate (PO <sub>4</sub> )	<0.06	<0.06	<0.06
Sulfate (SO <sub>4</sub> )	273	241	250
Chloride (Cl)	8	8	8
Silicate (SiO <sub>2</sub> )	5	<3	4
Carbonate (CO <sub>3</sub> )	60	300	600

---

<sup>1</sup>Ca, Mg, Na were analyzed in duplicate, the values are averaged.

<sup>2</sup>All values reflect dissolved, not total, concentrations.

Plant 1809. This plant is a 736-MW electric power generating station. Four boilers currently in operation burn bituminous coal which has an ash content of 10 to 12 percent. The boilers are of the wet bottom cyclone type and produce a relatively large amount of bottom ash slag. The plant utilizes a wet recirculating ponding system to handle both fly ash and bottom ash. Water is obtained from a nearby creek for use in the sluicing operation. A flow diagram of the ash handling system appears in figure VII-35.

The bottom ash sluicing system was retrofitted in 1974 along with the fly ash sluicing system and Unit 12, the largest of the steam generators (520 MW). All systems were designed and installed by Allen-Sherman-Hoff, retrofitted for Units 4, 5, and 6, and new for Unit 12. The principal reasons for installing the ash sluicing recycle system were the requirements of discharge regulations and the decision to collect and handle all process waters at one location. The fly ash and bottom ash is produced at a ratio of 26 percent fly ash to 74 percent bottom ash. In 1978, approximately 48,600 tons of fly ash were collected and 136,000 tons of bottom ash were collected.

A jet pump sluices the bottom ash from the slag tanks to the bottom ash runoff area. Two 12-inch diameter pipes are used to sluice the bottom ash; one from the Boiler 12 slag tank and one from Boilers 4, 5, and 6 slag tanks. The bottom ash sluice water flow rate is approximately  $3 \times 10^6$  gpd. At the bottom ash runoff area, the bottom ash slag is bulldozed into piles and is sold for use as a road bed aggregate. The runoff area is composed of two primary ponds, 11,536,000 and 14,198,000 gallons capacity, and one small secondary pond. Only one primary pond operates at a time. The bottom ash is sluiced every 4 hours for 30 to 45 minutes. The piping used for conveying the bottom ash is cast iron in the plant area and cast basalt (Sch. 80) outside the plant area. From the secondary pond, the sluice water overflows into the final pond for recirculation back to the jet pumps.

At the final pond, facilities are available for a discharge to Lake Michigan. These facilities consist of two pipes from the main conveying lines to Lake Michigan for intermittent and upset conditions. The discharge is actuated by gravity overflow. A discharge condition prevails when Unit 12 is operating. Usually when Units 4, 5, and 6 are operating and Unit 12 is down, the discharge condition does not exist. The final pond also receives a large amount of water from the miscellaneous sump system; thus, during heavy rainfall periods, a discharge condition often exists. Thus, Plant 1505 is not strictly a zero discharge plant. It does provide for a discharge under fairly consistent conditions when Unit 12 is operating. This discharge stream was not

quantified by plant personnel. The discharge is not used to prevent scaling of the ash handling components, but is used solely to remove the surplus water which accumulates. This surplus water is being considered for use as makeup to the cooling tower.

Operating problems associated with the sluice system are nominal. Occasional instances of low pH have caused some pipe corrosion; however, lime addition for pH adjustment has alleviated much of this problem. Scaling has historically not been a maintenance problem. Suspended solids have caused pump erosion problems on an intermittent basis. Currently, the creek is used as the makeup water source. High flow situations, e.g., after heavy rainfall, result in a poor quality makeup water; also, incomplete bottom ash settling caused some wear on pumps. Control of final pond water flow and installation of surface booms for floating material collection has mitigated much of the solids problem. The piping is rolled to maintain even wear on all inside sluicing surfaces. This procedure is not unusual. One area which requires significant maintenance is the sluicing jets and recirculation pumps. These pumps do not have spares and therefore must be frequently checked and maintained so as not to cause a shutdown of the sluicing operation.

The primary ponds are cleaned annually and only one primary pond is cleaned per year. Ash hauling is contracted to an outside trucking firm.

The bottom ash is sold for commercial use, which provides a credit for the ash. According to the 1978 FPC data provided by the plant personnel, the cost for collection and disposal of the bottom ash was \$79,200 and the sale of the bottom ash provided a \$29,900 credit.

The bottom ash ponding recycle sluicing system for plant 1505 was installed in 1974. At the same time the fly ash sluice water recycle system and unit 12 was installed. Thus, the recycle portion of the pond system is a retrofit system for units 4, 5, and 6. The reason for retrofitting a recycle system, i.e., a final pond and return line, was in part due to discharge regulations since the plant is bounded by a National Park, a town, and Lake Michigan. An additional motive was to collect all discharge streams in the final pond for common treatment, if needed.

The retrofit of the recycle line did not enable the plant to achieve zero discharge because of water balance problems. Water is accumulated especially when unit 12 is operating. The plant is in a low net evaporation climate. When the plant installed the recirculation system, the already-existing main sluicing jet



pumps and the new recirculation pumps were not spared. This has presented a maintenance problem and a need for redundancy by the plant is recognized.

The plant claims that it is difficult to achieve zero discharge by retrofitting a recycle loop on a ponding system for two reasons: it is difficult to tie up all the streams into one collection point, and it can be done only if the already-existing systems can be totally segregated. There is also the effect on electricity generation to be considered; higher auxiliary power requirements reflect lower net power generation. Plant 1809 personnel indicate that the technology to retrofit bottom ash systems is more available than that for retrofitting fly ash recycle systems. Cyclone boilers produce mostly bottom ash; however, cyclones are no longer available as a technology, primarily because of NO<sub>x</sub> emissions. According to plant personnel, the only way for plant 1809 to meet a zero discharge requirement is to install evaporators which would increase the auxiliary power requirements.

Any new expansion of generating capabilities would have to be met with pulverized coal boilers. No market for bottom ash from these boilers has been found by plant 1809 personnel, so the bottom ash handling systems would have to be segregated. Also, facilities to handle a larger percentage of fly ash would be installed with a pulverized unit.

Samples were taken at three different locations in the bottom ash sluicing system. These locations are shown in the bottom ash sluicing system diagram in figure VII-35 and are described as follows:

- o A sample was taken of the miscellaneous sump water,
- o A sample was taken of the bottom ash pond overflow, and
- o A sample was taken of the recirculating water from the final pond.

These samples provide data on the trace element, major species, and carbon dioxide content of transport streams at the settling ponds and of the sump water before the ponds. The trace elements analyzed for were silver, arsenic, beryllium, cadmium, chromium, copper, mercury, nickel, lead, antimony, selenium, thallium, and zinc. The major species assayed were calcium, magnesium, sodium, phosphate, sulfate, chloride, silicate, and carbon dioxide. The results of these analyses are presented in tables VII-32 and VII-33.

Table VII-32

TRACE ELEMENTS/PRIORITY POLLUTANTS CONCENTRATIONS<sup>1,2</sup>  
AT PLANT 1809(ug/l)<sup>1</sup>

	<u>Sluice Water from Recirculation Pond</u>	<u>Bottom Ash Pond Overflow</u>	<u>Miscellaneous Sump</u>
pH	7.9	7.9	7.7
Temp (°F)	80	85	80
Silver	<0.1 <sup>3</sup>	<0.1	<0.1
Arsenic	66	12	12
Beryllium	<0.5	<0.5	<0.5
Cadmium	0.7	1.0	1.0
Chromium	3	<2	3
Copper	5	3	16
Mercury	<1.0	<1.0	4.0
Nickel	17	29	<3
Lead	<2	<2	3
Antimony	9	8	<3
Selenium	4	<2	<2
Thallium	62	56	6
Zinc	70	50	100

<sup>1</sup>All samples were analyzed in duplicate, the values were averaged.

<sup>2</sup>All analytical values are for dissolved concentrations, the samples were filtered initially.

<sup>3</sup>The value <.1 indicates that the concentration was below the detection limit which is 0.1 g/l.

Table VII-33  
 MAJOR SPECIES CONCENTRATIONS<sup>1,2</sup>  
 AT PLANT 1809

(mg/l)

	<u>Sluice Water from Recirculation Pond</u>	<u>Bottom Ash Pond Overflow</u>	<u>Miscellaneous Sump</u>
Calcium	125	115	63
Magnesium	60	58	24
Sodium	50	48	19
Phosphate (PO <sub>4</sub> )	0.06	<0.06 <sup>3</sup>	0.11
Sulfate (SO <sub>4</sub> )	633	650	149
Chloride (Cl)	16	18	14
Silicate (SiO <sub>2</sub> )	6	5	5
Carbonate (CO <sub>3</sub> )	1080	1020	1800

<sup>1</sup>Ca, Mg, Na samples were analyzed in duplicate, the results were averaged.

<sup>2</sup>These concentrations reflect dissolved, not total, concentration.

<sup>3</sup>The value <.06 reflects a concentration below the detection limit which in this case is 0.06 mg/l.

Results from the sampling of trace elements indicate that only one concentration increased due to exposure to the bottom ash. The concentration of nickel in the bottom ash pond overflow is higher than in the final pond effluent which serves as the makeup water to the bottom ash sluicing system.

On the basis of this sampling and analysis, the tendencies for scaling in the sluice streams were determined through an aqueous equilibrium program. Based on the aqueous equilibrium results, of calcium carbonate theoretically has the greatest potential for precipitation in the sluice water from the final pond; next greatest in the bottom ash pond overflow, and the least potential in the miscellaneous sump stream. None of the streams indicated a high scaling potential.

The feasibility of a closed-loop zero discharge operation cannot be established based on the information available from this plant since there is fairly continuous discharge. This discharge is due to an inherent accumulation of water in the recycle loop under certain operating conditions.

#### LOW-VOLUME WASTES

One treatment technology applicable for the treatment of low-volume waste streams is vapor-compression evaporation (VCE). Although this method of waste treatment is energy intensive, it yields a high-purity treated water stream and significantly reduces the wastewater effluent flow. A number of the low-volume waste streams described in Section V are suitable for VCE treatment. These streams are:

- o Water Treatment
  - Clarifier blowdown (underflow)
  - Make-up filter backwash
  - Lime softener blowdown
  - Ion exchange softener regenerant
  - Demineralizer regenerant
  - Reverse osmosis brine
  - Evaporator bottoms
- o Boiler blowdown
- o Floor and laboratory drains.

The VCE process concentrates non-volatile effluents from these sources. This produces a concentrated brine which is usually ponded in arid regions or sent to a pond or treated in a spray dryer in non-arid regions (49).

## Process Description

A schematic flow diagram of a VCE system is shown in figure VII-46. The wastewater is first treated in a feed tank to adjust the pH to between 5.5 and 6.5 for decarbonation. The stream is then pumped through a heat exchanger to raise its temperature to the boiling point. In some instances, softening may be required to prevent scaling in the heat exchanger. After passing through a deaerator which removes dissolved gases, the hot waste stream is combined with the slurry concentrate in the evaporator sump. This slurry is constantly recirculated from the sump to the top of the evaporator tubes. The slurry flows as a thin film down through the tubes and vaporizers. The vapor is compressed and introduced to the shell side of the tube bundle. As this stream condenses, it transfers its heat of vaporization to the brine slurry. The condensate that results on the shell side is pumped through the feed preheater to transfer as much heat as possible to the process before it is discharged from the unit. A portion of the brine slurry is continuously drawn off from the sump to maintain a constant slurry concentration (200,000 to 400,000 mg/l solids) (51, 52).

The formation of scale is avoided on heat transfer surfaces by preferential precipitation of calcium sulfate silica on seed crystals in the slurry. In addition, a small temperature difference across the heat exchanger tubing minimizes scale formation on the evaporating surfaces (39).

## Effectiveness

VCE systems have taken streams containing between 3,000 and 50,000 mg/l of total dissolved solids (TDS) and have yielded a brine stream containing 200,000 to 400,000 mg/l TDS and a stream of water containing less than 10 mg/l TDS. In the event that there are significant amounts of priority pollutants present in the feed stream, it may be necessary to attach additional treatment equipment to the deaerator vent, e.g., carbon adsorption or incineration.

## Brine Slurry Concentration and Disposal

### Evaporation Ponds

For areas of the country where the net annual evaporation rate (gross evaporation minus rainfall) exceeds 20 inches a year, use of evaporation ponds for disposal of VCE waste brines may be a viable disposal method. Evaporation ponds are used as a final wastewater disposal method throughout the electric utility industry, primarily in the southwestern states; however, land cost and governmental regulations restrict the use of evaporation ponds at many plant sites.

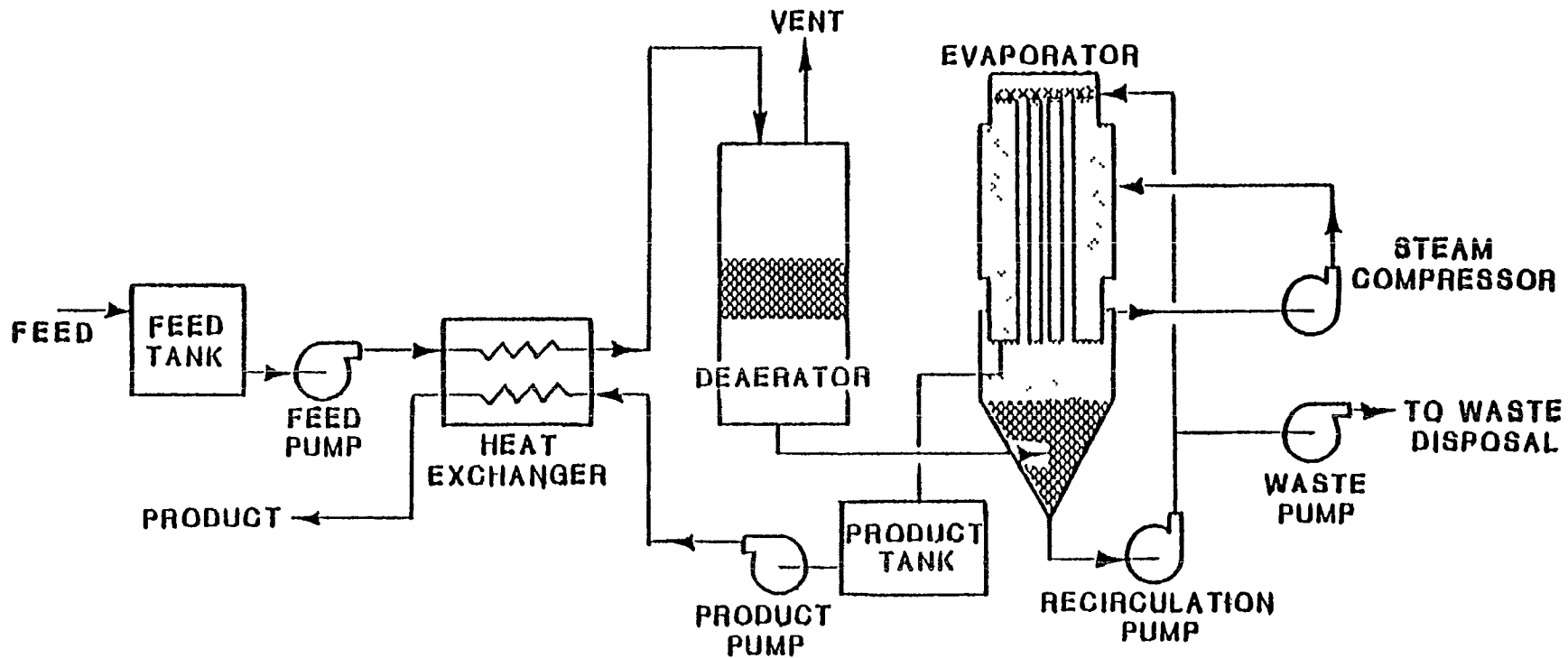

Figure VII-46  
SIMPLIFIED, SCHEMATIC DIAGRAM OF A VAPOR COMPRESSION EVAPORATION UNIT (50)

Evaporation ponds use solar energy to evaporate wastewater and thereby concentrate dissolved solids in the wastewater. The ponds are constructed by excavation, by enclosing an area with dikes, by building dams, or by a combination of these methods. Ponds may require a liner to prevent seepage of wastewater into the natural pond water supplies. Typical liners are clay, asphalt, and PVC sheets. The area required for a single evaporation pond can be estimated by equation 24:

$$\text{Area (acres)} = \frac{19.5G}{V} \quad (24)$$

where G is the wastewater flow rate in gallons per minute and V is the effective net evaporation rate in inches per year.

The effective net evaporation rate of pond water is less than the area net evaporation rate. This occurs because of the decreasing pond water vapor pressure with increased dissolved solids content of the pond water. Consequently, some systems use ponds in series where the effective evaporation rate of the first ponds is greater than the evaporation rate of the latter ponds. The pond depth required is equal to the wastewater flow rate in acre-feet per year divided by the pond area in acres required for evaporation. Additional depth is required for solids build-up in the pond.

#### Spray Drying

For areas of the country where evaporation by ponding is not feasible, thermal drying of the waste brine to produce a solid for disposal by land fill is an option. Spray dryers have been proposed as a suitable method for thermal drying of VCE waste brines.

In a spray dryer, the VCE waste brine is atomized either by a spray nozzle or a high-speed rotating disk. Hot combustion gases contact the atomized brine in the drying chamber and vaporize the water. The hot flue gases and dried brine crystals pass through a baghouse for brine crystal removal before being vented to the atmosphere. Moisture content of the dried brine crystals is less than 5 percent (51).

#### METAL CLEANING WASTES

As explained in Section V, metal cleaning wastes are, periodic discharges that may occur only infrequently at many power stations. Since they are infrequent, many plants prefer to have them hauled off and treated by private contractors. Most of the expertise for treating cleaning wastes has been developed by the

cleaning contractors. Current treatment methods include incineration, ash basin treatment, and physical-chemical treatment. In addition, treatment by vapor compression evaporation also has been considered.

### Treatment Methodologies

Disposal by Incineration (Evaporation). Incineration (evaporation) of boiler chemical cleaning solutions has gained increasing popularity since its first commercial application in 1971 (53). A number of utilities have used such a process for disposal of waste boiler cleaning solutions of various types, including ammoniated EDTA, ammoniacal bromate, citric acid, and hydroxyacetic/formic acid containing ammonium bifluoride (54, 55, 56). To date, well over 125 such incinerations of ammoniated EDTA waste solutions alone have occurred.

The incineration procedure involves the controlled injection of spent boiler cleaning chemicals into the firebox of an operational boiler (see figure VII-47). As the solution is injected, water is vaporized and the organics are combusted. The organic materials are reduced to such compounds as  $N_2$ ,  $CO_2$ , and  $H_2O$  while iron and copper deposits from the cleaning are transformed to oxides (57). These boiler chemical cleaning wastes are combustible to some extent due to these organic molecules and metal compounds. Ammoniated EDTA has been estimated to have a heat value of 2,000 Btu/pound.

Injection rates are dependent on the fan and fuel capacity of the boiler and must be determined on an individual basis. However, the gallon per minute incineration rate has been equivalent to approximately 2 to 5 percent of the steam flow of the boiler in a number of cases (58). Injection rates range from 20 to 180 gallons per minute.

Solvent injection has been tested in coal, oil, and gas fired boilers, both above and below the burners, and at various spray angles. Tests have shown that disposal through incineration has successfully captured metals. At times, as high as 98 percent iron and 95 percent copper from the injected waste solutions have been retained in the furnace.

The transition of metal ions to oxides is chemical in nature. These oxides are then physically transformed to small particles and either leave the stack or are trapped as deposits between the point of combustion and the stack outlet. Since ash is primarily composed of metallic oxides in various proportions, it would be expected that deposition would occur along with bottom or fly ash, in pollution control equipment or on walls of the furnace or stack.



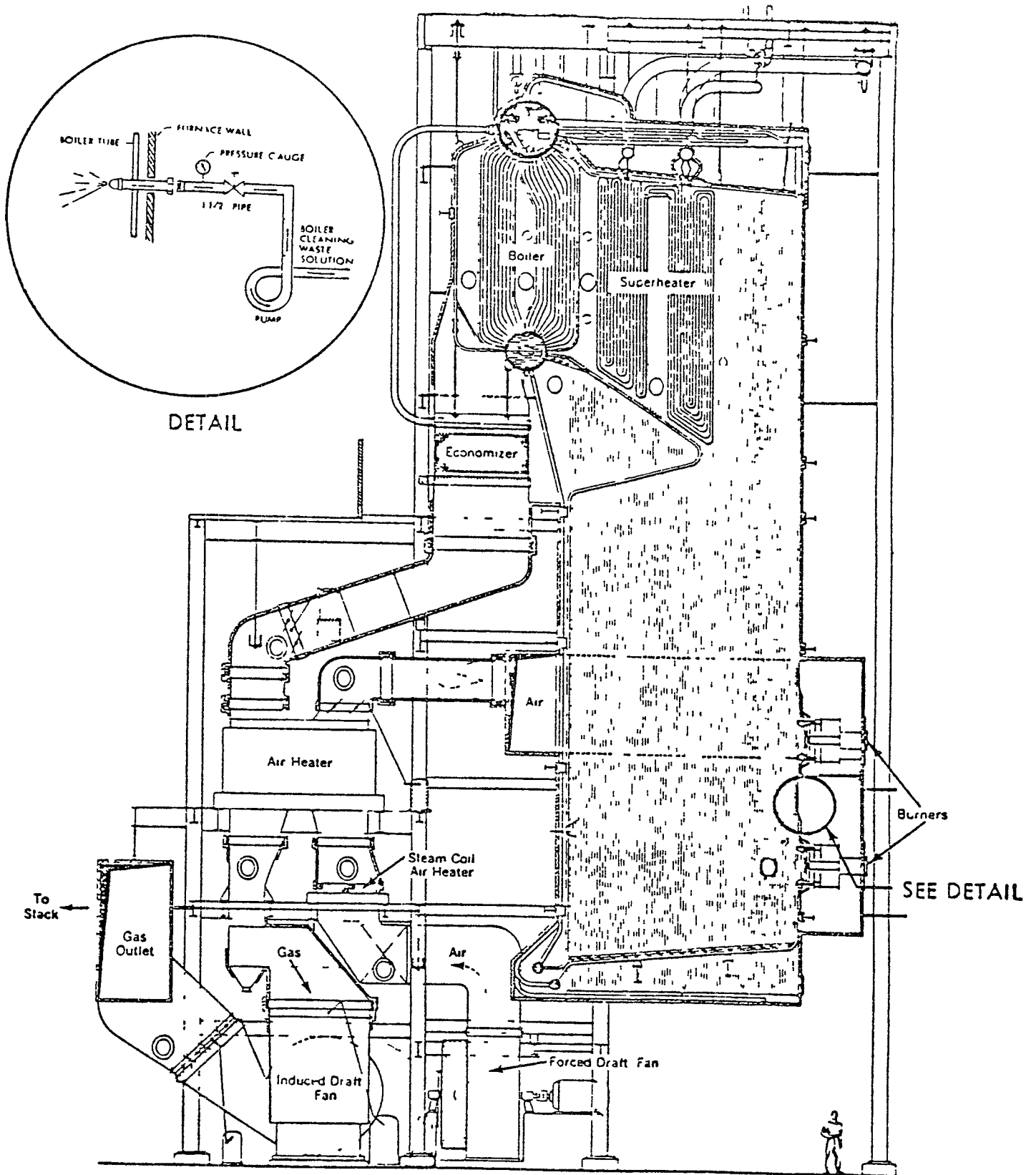

Figure VII-47  
 TYPICAL PIPING DIAGRAM AND LOCATION FOR INCINERATION  
 OF BOILER CHEMICAL CLEANING WASTES (68)

Other substances which are of concern were also evaluated in incineration studies. Such cases concerned the disposal of ammoniacal bromate, and hydroxyacetic/formic acid containing ammonium bifluoride. Thermogravimetric analysis revealed that sodium bromate was converted to sodium bromide and oxygen at 752°F and that no obnoxious products were formed at temperatures up to 1,850°F (54). Actual incineration tests on these solutions in a 860°F boiler revealed no liberation of halogen gas or other obnoxious gases.

Some tests conducted during incineration of boiler cleaning wastes have shown that sulfur dioxide (SO<sub>2</sub>) and the oxides of nitrogen (NO<sub>x</sub>) have been reduced in stack emissions. Explanation of the lower NO<sub>x</sub> levels may stem from the dissociation of water, which replaces oxygen supplied by air thereby lowering the air and nitrogen supply to the furnace (58).

Ash Basin Treatment. A number of utilities employ ash ponds for the treatment of boiler chemical cleaning wastes (57, 59). The theory behind such a treatment scheme is that the chemical/physical nature of the ash pond environment will treat those wastes as well as conventional lime treatment.

A number of basic characteristics of the ash pond are utilized to treat these wastes. The most important characteristic is pH, since metals are removed as precipitated hydroxides above a certain pH. Many ash ponds are naturally alkaline and thus have a good potential for metal-hydroxide formation.

The presence of fly ash in ash ponds also appears to be an aid in the treatment scheme (60). Fly ash has been used in water treatment to increase the rate of floc growth and to enhance floc settling properties. Some studies have shown that ashes which raise the pH of ash sludge water can be expected to precipitate heavy metals (60).

In one of the demonstration projects on ash basin treatment, dissolved oxygen content of the ash pond was felt to be an important factor (60). In theory, its presence provided the oxidizing potential to convert iron ions from the ferrous to the ferric state, the latter which could be precipitated at a lower pH than the former.

The dilution factor of the ash pond is also felt to be important in breaking the ammonia complex bond in the ammoniacal bromate solution, thus allowing the precipitation of copper. In order to achieve equivalent metal removal, the increase in the concentration of the metal in the ash pond effluent must be equal to or less than the concentration achievable by lime precipitation divided by the dilution factor.

Physical/Chemical Treatment. A number of treatment schemes employing physical/chemical processes have been tested, designed, and implemented for the treatment of boiler chemical cleaning wastes. The basic mechanism behind these treatment schemes involves neutralization with caustic or lime followed by precipitation of the metal hydroxide compounds (57, 61, 62, 63, 64, 65). However, there are a number of additional unit processes which have been employed on certain waste chemical solutions in order to increase the degree of attainable reduction of certain constituents. These additional unit processes include: mixing with other metal cleaning waste sources, oxidation, sulfide addition, filtration, and carbon adsorption.

In the treatment of waste boiler chemical cleaning solutions the use of these unit processes, either alone or in combination with others, is dependent upon which waste solution is being treated. Various characteristics of individual waste streams make the use of certain unit processes feasible. A description of the use of these processes as they apply to boiler chemical cleaning wastes follows.

Ammoniated Citric Acid. Ammoniated citric acid boiler cleaning wastes contain amounts of complexed iron and copper. Chelation of iron by citrate is the first step of the two step process which is followed by ammonia addition to complex copper. Dilution is necessary to dissociate the ammonia-copper complex and will aid in breaking the iron-citrate chelate. Adjustment of pH upwards will further lower the degree of complexation as figure VII-48 illustrates.

Aeration of this waste has been recommended in order to oxidize cuprous and ferrous ions to the cupric and ferric state, thus lowering the pH needed to precipitate the copper and iron (57).

Addition of sodium sulfide after aeration under acidic conditions in one treatment scheme reduced metal concentrations due to the precipitation of metal sulfides. In this treatment scheme, clarifier overflow was filtered through a dual media gravity filter to produce final effluent with iron and copper concentration below one (1) mg/l (57).

Ammoniated EDTA. Waste ammoniated EDTA boiler and chemical cleaning solutions are difficult to treat due to the metal complexes which are present. EDTA is a hexadentate ligand which chelates iron, while the ammonia forms complexes with copper. However, these wastes are effectively treated to below the one (1) mg/l level for iron and copper using a combination of unit processes.

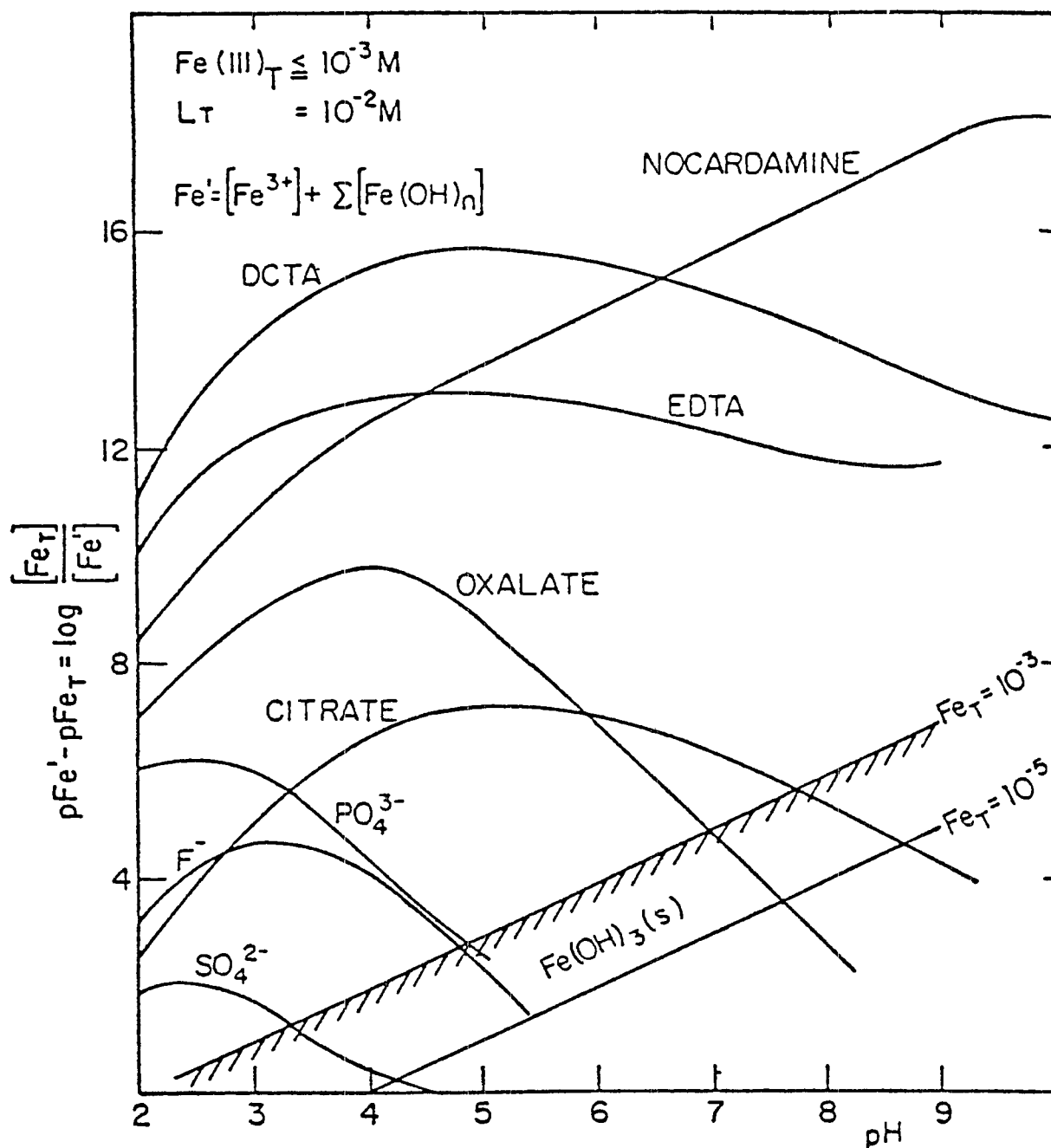

Figure VII-48  
COMPLEXING OF Fe(III) (69)

The degree of complexation is expressed in terms of pFe for various ligands ( $10^{-2} M$ ). The competing effect of  $H^+$  at low pH values and of  $OH^-$  at higher pH values explains that effective complexation is strongly dependent on pH. Mono-, di- and tri-dentate ligands ( $10^{-2} M$ ) are not able to keep a  $10^{-3} M$  Fe(III) in solution at higher pH values.

Dilution in plant wastes such as air preheater wastes and boiler fireside wastes have effectively achieved the dissociation of these complexes and subsequent removal of the copper (57, 66). The presence of sulfides in these wastes, resulting from burning sulfur-containing fuels, helps remove copper by the formation of insoluble copper sulfide (57, 67). When dilution is followed by lime addition to pH levels of approximately 13, reduction of iron and copper levels below 1 mg/l may be achieved (57). Addition of a polymer to aid in flocculation has been used in order to achieve maximum removal of metals (57).

Ammoniacal Sodium Bromate. Reduction of total copper in waste ammoniated sodium bromate solutions first requires the dissociation of the ammonia-copper complexes. This step is required in order to free the copper, thus allowing it to form insoluble hydroxide precipitates.

Figure VII-49 illustrates the degree of complexation of  $\text{NH}_3$  on  $\text{Cu}^{2+}$  to be a function of dilution. In the left hand graph,  $\text{pCu}^{2+}$  first increases as ammonia equilibrium forces it to enter into solution (thereby shifting the copper species to the lower ammoniated form) then decreases as dilution effects predominate. The second graph shows the degree of complexation decreasing with dilution due to the increase in the  $\text{Cu}^{2+}$  species. Although other factors such as temperature and ionic activity affect solubilities, dilution will aid in the dissociation of the ammonia/copper complex.

Once this dissociation is accomplished, aqueous copper may be precipitated with hydroxides. Addition of lime ( $\text{Ca}(\text{OH})_2$ ) provides the necessary hydroxides and precipitation will occur at approximately  $\text{pH} = 10$ . Flocculation may be enhanced with addition of an organic polymer flocculating agent. Sedimentation may be followed by the passage of the supernatant through a granular media filter to insure effluent quality. Reduction of iron and copper to below the one mg/l level was accomplished using the overall treatment scheme in figure VII-50.

Hydrochloric Acid Without Copper Complexer. Many times HCl (without copper complexer) is used in conjunction with ammoniated sodium bromate solutions, and will be incorporated with the treatment scheme for that solution. However, it may be used for removing heavy scales in boiler systems which do not contain copper, and thus the waste solution will not contain these relatively hard-to-break copper complexes. Effluent levels for iron and copper below one mg/l are expected as treatment levels attainable for metals will approach theoretical solubilities when pH is adjusted.

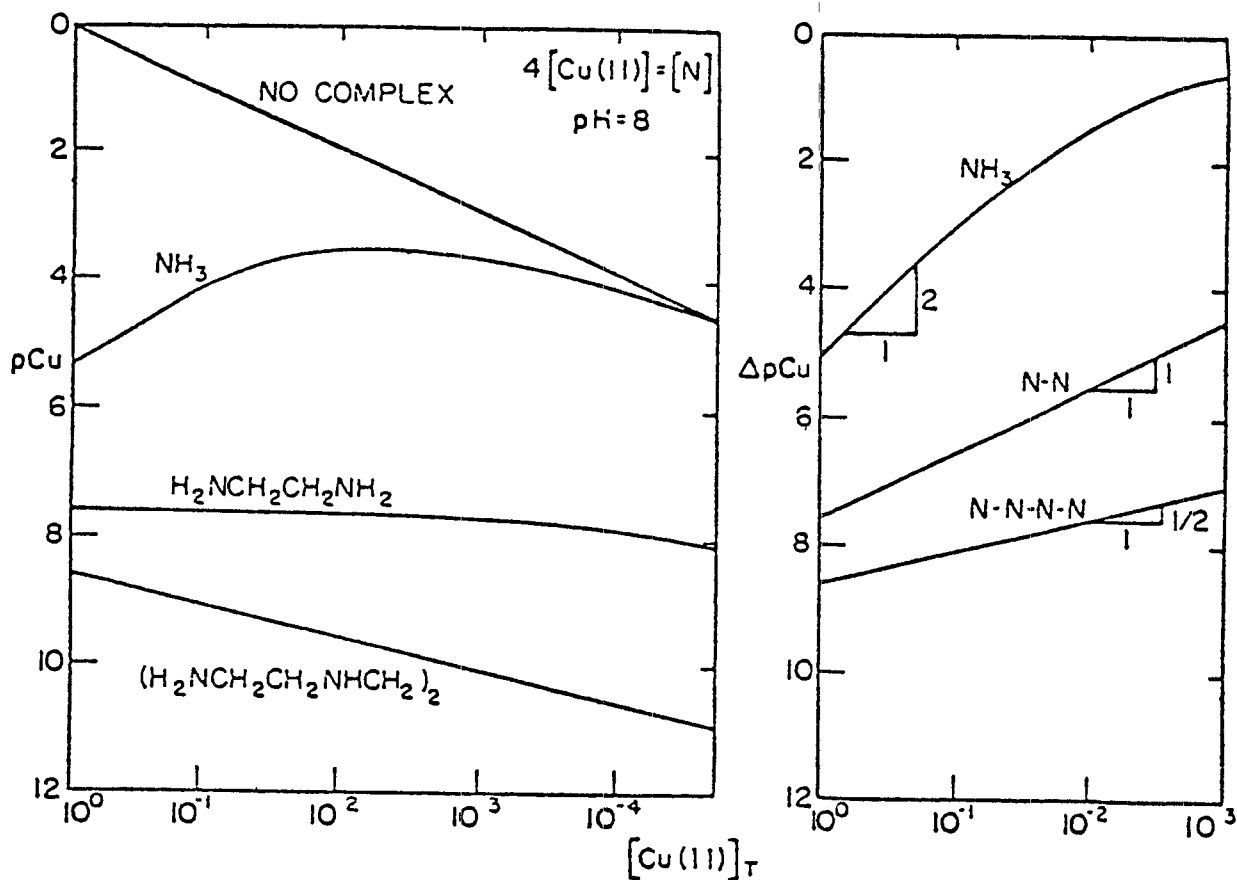

Figure VII-49

THE CHELATE EFFECT ON COMPLEX FORMATION OF  $Cu-aq^{2+}$  WITH MONODENTATE, BIDENTATE AND TETRADENTATE AMINES  $pCu$  IS PLOTTED AS A FUNCTION OF CONCENTRATION IN THE LEFT-HAND DIAGRAM. IN THE RIGHT THE RELATIVE DEGREE OF COMPLEXATION AS MEASURED BY  $pCu$  AS A FUNCTION OF CONCENTRATION IS DEPICTED (69)

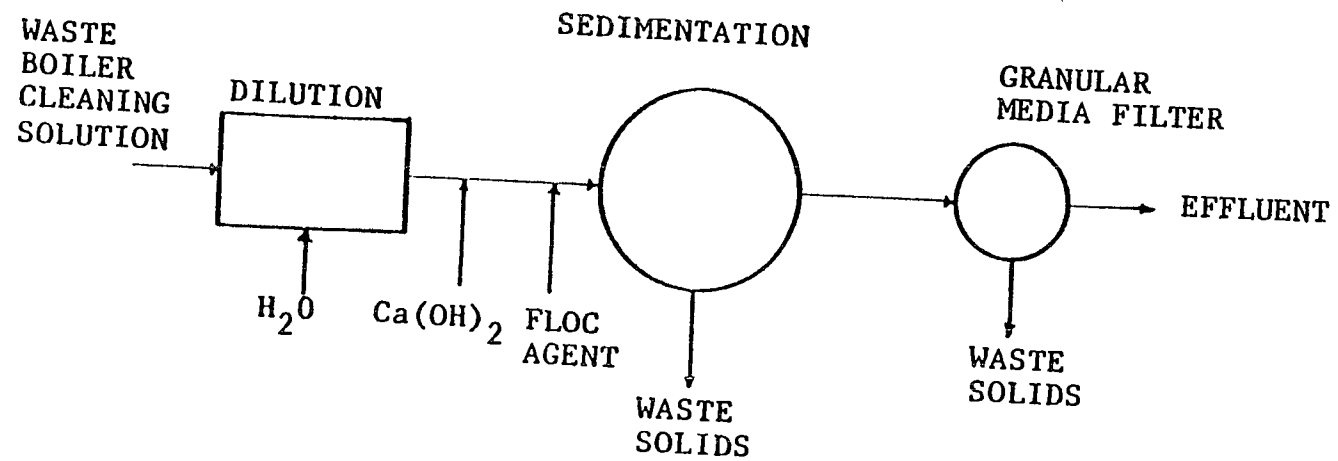

Figure VII-50  
TREATMENT SCHEME FOR METALS REMOVAL BY  
PRECIPITATION FROM WASTE BOILER CLEANING SOLUTION

Figure VII-51 shows theoretical solubilities of a number of metals as a function of pH. From the diagram it may be seen that those metals found in waste hydrochloric acid cleaning solutions may be removed below 1 mg/l with pHs adjusted to approximately pH = 10. The adjustment of pH may be with the lime or sodium hydroxide, although sludge dewaterability is best when lime is used.

The treatment scheme employed for this waste stream is pH adjustment, sedimentation, and (possibly) polishing of supernatant with some form of filtration.

Hydrochloric Acid With Copper Complexer. Thiourea and Cutain II are two copper complexing agents which have been employed along with hydrochloric acid for the cleaning of boiler systems containing copper alloys. Successful treatment of these wastes, to obtain total metal residuals for iron and copper of below 1 mg/l each (61), involves breaking the copper complex and precipitating metal hydroxides.

Thiourea and Cutain II are multidentate ligands and, as such, are more stable than the ammonia-copper complex, ammonia being a monodentate ligand. Therefore, the same degree of dilution of these hydrochloric wastes to dissociate the complex is not as effective as it is for the degree of complexation.

In most cases, dilution occurs by combining acid stage wastes with rinse waters or other metal cleaning wastes. The effect of such dilution may be found in bench-scale test data contained in table VII-34. In this case, wastes were diluted and pH was adjusted to 9.5, where metals were precipitated and then the samples were filtered.

Another system using a similar treatment method also successfully removed metals below the 1 mg/l level. In addition, activated carbon has been used in order to absorb further the metal-complex species and toxic acid inhibitory chemicals (57).

Hydroxyacetic/Formic Acid. This chemical solution has found wide use in cleaning supercritical boilers because of its high iron pickup capabilities. The hydroxyacetic/formic acid solution chelates iron, and as such, is subject to dilution in order to dissociate the complex. Dilution with other plant wastes followed by oxidation (to change iron from the ferrous to the ferric state) and pH adjustment should yield an effluent with iron and copper below the 1 mg/l level.



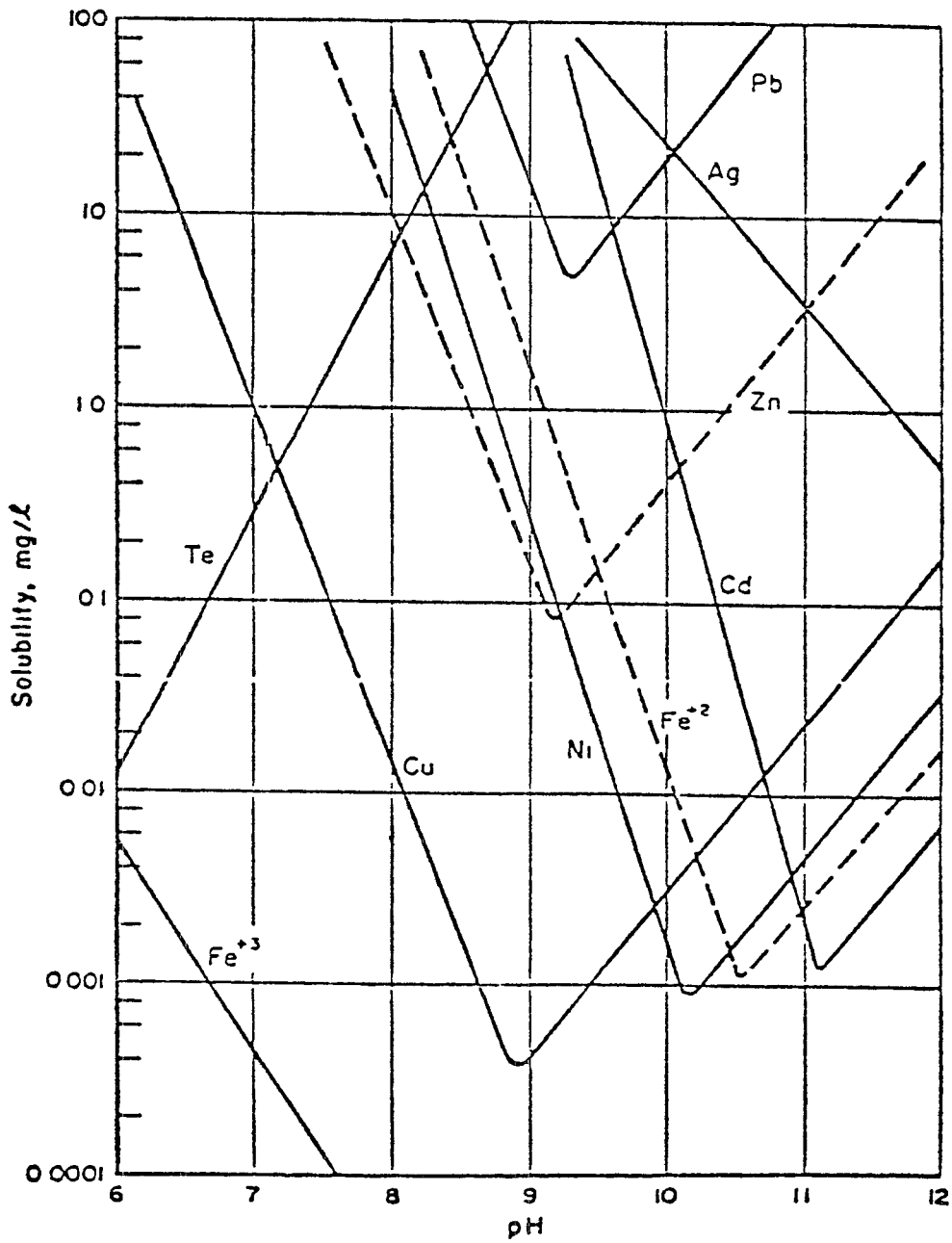

Figure VII-51

THEORETICAL SOLUBILITIES OF METAL IONS AS A FUNCTION OF pH (69)

Table VII-34  
TREATMENT OF ACID CLEANING WASTEWATER  
SUMMARY OF JAR TESTS (61)

Concentration (mg/l)

<u>Dissolved Metals</u>	<u>Before Treatment</u>		<u>After Treatment</u>		
Zn	335	0.02	0.045	0.2	0.74
Ni	375	0.04	0.13	0.31	2.9
Cu	306	0.03	0.34	0.32	0.35
Fe	5,140	0.14	0.31	0.60	0.52
Mn	41	.01	.01	0.04	0.12
V	0.8	.1	.1	.1	0.5
Dilution prior to treatment	-----	20 1	10 1	5 1	None

pH adjusted to 9.5 with lime

Source    Design Report Wastewater Treatment Facilities, New  
            England Power Service Company

Sulfuric Acid. Sulfuric acid, though used infrequently, may be employed on certain austenitic type alloys for the removal of heavy deposits. There are no complexing agents used in conjunction with this chemical, and thus treatment is believed to be similar to that of hydrochloric acid (without copper complexer).

#### Treatment Levels

Incineration (Evaporation). Disposal of waste boiler cleaning solutions by means of incineration (evaporation) has been tested for disposal capacities during a number of tests. Although metals were released to the environment, the organic content of the waste streams, along with obnoxious gases, were found to be nonexistent in the stack emissions. Problems could arise if stack controls are absent (57). The high temperature environment of the firebox area was shown to break down the organic content of the waste.

One means of measuring the impact of stack emissions is by estimating ground level concentrations with the Threshold Limit Values (TLV) for various components. TLV is defined as the time-weighted average exposure to an airborne contaminant for a period of eight hours a day, five days a week, over an individual's working lifetime, which will not produce adverse effects (56). Examination of various components of stack emissions for their TLV as fumes and dusts and mists, has been used by the Environmental Protection Agency for regulatory purposes. Such examination of incineration operations of waste boiler cleaning solutions has shown TLV of the various metals found in stack emissions to be below the allowable limits set by EPA.

These low TVL values are a result of heavy metals components of the waste solutions being retained in the boiler stack areas with efficiencies approaching 98 percent in some cases. However, even at this level, considerable amounts of heavy metals leave the stack as a result of incinerating waste boiler chemical cleaning solutions. If these emissions were distributed in a volume of water equal to that of the original waste volume, the effluent concentration (Equivalent Treated Effluent Concentration) would be orders of magnitude larger than present limits (1 mg/l). Table VII-35 illustrates the point for a number of incineration tests.

Ash Pond Treatment. The mechanisms believed to be incorporated by the chemical/physical nature of ash ponds for treatment of boiler cleaning wastes are the same as those which were found to be effective in physical/chemical treatment processes (i.e., dilution, oxidation, pH adjustment, precipitation). However, with the ash ponds, control of these variables may be difficult

Table VII-35

## EQUIVALENT TREATMENT OF INCINERATION TESTS

<u>Waste Characteristics</u>		<u>Percent Retained</u>	<u>Equivalent Treated Effluent Concentration</u>
<u>Volume</u>	90,850 liters		
Iron	727.27 kg	94	480 mg/l
Copper	163.64 kg	88	216 mg/l
Nickel	36.36 kg	90	40 mg/l
<u>Volume</u>	218,039 liters		
Iron	4142.74 kg	81	3456 mg/l
Copper	69.77 kg	94	19 mg/l

(if not impossible) and thus the question of attainment of effluent limitations. The level achievable in the ash pond must be equal to the original level in the ash pond prior to metal cleaning waste addition plus the value determined by dividing the effluent limitation (1 mg/l) by the dilution factor. Because of the accuracy and precision of the analytical methods, such demonstration may not be possible in some cases.

Physical/Chemical Treatment. Physical/chemical treatment methods have been used successfully to treat solutions of chelated metals. By employing various unit processes, it is possible to have control of all reactions needed to reduce the levels of heavy metals in waste boiler cleaning chemical solutions to below the one mg/l level. Table VII-36 shows the treatment levels of various treatment schemes.

#### COAL PILE AND CHEMICAL HANDLING RUNOFF

One treatment technology applicable to coal pile and chemical handling runoff is chemical precipitation/sedimentation. Chemical precipitation is discussed in the ash handling subsection of this section. Sedimentation is discussed in the 1974 Development Document (46).

#### Flue Gas Cleaning Discharges

In general flue gas cleaning processes employing wet scrubbing make maximum use of recycle of slurry water. Typical systems use thickeners which produce a high solids waste stream which is ponded and a supernatant which is recycled to the scrubber. The solids settling is typically accomplished in a pond where much of the water is retained as a part of the settled sludge. This water which overflows the pond is either recycled or discharged. While it was originally believed that most, if not all, such systems could operate in a closed-loop or zero discharge mode supporting data to confirm this is not available. The Agency plans to continue research into scrubber system discharges and their control.

Table VII-36

PHYSICAL/CHEMICAL TREATMENT PROCESSES  
AND EFFICIENCIES

<u>Waste Type and Treatment Scheme</u>	<u>Parameter</u>	<u>Effluent Concentration (mg/l)</u>
<u>Hydrochloric acid with copper complexer</u>		
Dilution + precipitation at pH = 1 sedimentation + filtration (61)	Fe	0.01
	Cu	0.14
	Zn	0.02
	Ni	0.04
	Mn	0.01
<u>Ammoniated EDTA</u>		
H <sub>2</sub> S addition + precipitation at pH = 13 + sedimentation (57)	Fe	0.5
	Cu	0.61
<u>Ammonical bromate + hydrochloric acid</u>		
Dilution + precipitation at pH = 8.2 sedimentation + filtration (66)	Fe	*
	Cu	*
	Zn	*
	Ni	*

\*Indicates that the value is below the detection limit.

## SECTION VIII

### COST, ENERGY, AND NON-WATER QUALITY ASPECTS

The cost, energy, and land requirements of the various treatment and control technologies described in section VII are presented in this section for typical steam electric powerplants. For most technologies, the costs are estimated for 25, 100, and 1,000 MW plants. For some of the fly ash handling technologies, the costs are estimated for 25, 100, 200, 350, 500, and 1,000 MW plants, in order to provide better information regarding the change in fly ash handling costs with decreasing plant size. Only summary information is provided in this section. All costs are presented in 1979 dollars unless otherwise noted. A discussion of the non-water quality environmental effects of the various treatment and control technologies is also provided in this section.

#### COOLING WATER

##### Once-Through Cooling Water Systems

The capital cost, operating and maintenance costs, energy requirements, and land requirements have been evaluated for the following technologies:

- Chlorine minimization,
- Dechlorination,
- Alternative oxidizing chemicals
  - chlorine dioxide
  - bromine chloride
  - ozone, and
- Non-oxidizing biocides.

##### Chlorine Minimization

Cost, Energy, and Land Requirements. Summary cost, energy and land requirements for chlorine minimization at both new and existing plants are presented in table VIII-1. The requirements for retrofitting an existing plant are identical to the requirements for a new plant.

Non-Water Quality Aspects. There are no non-water quality environmental effects identified with the use of chlorine minimization.

##### Dechlorination

Costs, Energy, and Land Requirements. Summary costs, energy and land requirements at both new and existing plants for dechlorination of once-through cooling water systems are presented in table VIII-2. The requirements for retrofitting an existing plant are identical to the requirements for a new plant.

Table VIII-1

SUMMARY OF COST, ENERGY, AND LAND REQUIREMENTS FOR  
CHLORINE MINIMIZATION IN ONCE-THROUGH COOLING WATER SYSTEMS

	<u>Plant Size (MW)</u>		
	<u>25</u>	<u>100</u>	<u>1,000</u>
Capital Cost (\$)	36,000	37,000	38,700
Operation and Maintenance (\$/year)	9,200	9,100	8,500
Energy Requirements (kwh/year)	negligible	negligible	negligible
Land Requirements (acres)	none	none	none

Table VIII-2

SUMMARY OF COST, ENERGY, AND LAND REQUIREMENTS FOR  
DECHLORINATION IN ONCE-THROUGH COOLING WATER SYSTEMS

	<u>Plant Size (MW)</u>		
	<u>25</u>	<u>100</u>	<u>1,000</u>
Capital Cost (\$)	77,000	91,500	127,000
Operation and Maintenance (\$/year)	20,000	36,400	84,900
Energy Requirements (kwh/year)	3.2x10 <sup>4</sup>	5.6x10 <sup>4</sup>	1.12x10 <sup>5</sup>
Land Requirements (acres)	none	none	none

NOTE: Updated costs of chlorine control are presented in "Costs of Chlorine Control Options for Once-Through Cooling Systems at Steam Electric Power Plants," October 1981, Radian Corporation for EPA.



Non-Water Quality Aspects. There are no non-water quality environmental effects identified with the use of dechlorination technology.

### Recirculating Cooling Water Systems

The capital cost, operational and maintenance costs, energy requirements, and land requirements have been evaluated for the following technologies:

- Dechlorination,
- Non-Oxidizing Biocides,
- Corrosion and Scaling Control, and
- Asbestos Cooling Tower Fill Replacement.

#### Dechlorination

Cost, Energy, and Land Requirements. Summary cost, energy and land requirements for dechlorination at both new and existing plants using recirculating cooling water systems are presented in table VIII-3. The requirements for retrofitting an existing plant are identical to the requirements for a new plant.

Non-Water Quality Aspects. Dechlorination of cooling tower blowdown is not expected to result in any non-water quality environmental effects.

#### Non-Oxidizing Biocides

Costs, Energy, and Land Requirements. As detailed in Section VII, the technology evaluated for the control of the discharge of priority pollutants contained in non-oxidizing biocide formulations is substitution. No additional costs, energy or land requirements are expected to be involved in the use of nonpriority pollutant mixtures, as shown in table VIII-4.

Non-Water Quality Aspects. Switching to non-priority pollutant-containing, non-oxidizing biocides is not expected to have any non-water quality effects.

#### Corrosion and Scaling Control Chemicals

Cost, Energy, and Land Requirements. As detailed in Section VII, the technology evaluated for the control of the discharge of priority pollutants contained in scaling and corrosion control formulations is substitution. The additional costs, energy and land requirements incurred in switching from a priority pollutant-containing, scaling and corrosion control mixture to one that contains no priority pollutants are presented in table VIII-5.

Table VIII-3

SUMMARY COST, ENERGY AND LAND REQUIREMENTS FOR  
 DECHLORINATION OF RECIRCULATING COOLING SYSTEM DISCHARGE  
 (BLOWDOWN)

	<u>Plant Size (MW)</u>		
	<u>25</u>	<u>100</u>	<u>1,000</u>
Capital Cost (\$)	54,200	54,200	57,200
Operation and Maintenance (\$/year)	6,100	6,100	6,300
Energy Requirements (kwh/year)	1.6x10 <sup>3</sup>	1.6x10 <sup>3</sup>	1.6x10 <sup>3</sup>
Land Requirements (acres)	negligible	negligible	negligible

Table VIII-4

SUMMARY COST, ENERGY AND LAND REQUIREMENTS FOR SWITCHING  
TO NON-PRIORITY POLLUTANT CONTAINING NON-OXIDIZING BIOCIDES

	<u>Plant Size (MW)</u>		
	<u>25</u>	<u>100</u>	<u>1,000</u>
Capital Cost (\$)	None	None	None
Operation and Maintenance (\$/year)	The O&M cost (chemical purchase cost) of non-priority pollutant non-oxidizing biocides is less than for chlorinated phenols.		
Energy Requirements (kwh/year)	None	None	None
Land Requirements (acres)	None	None	None

Table VIII-5

SUMMARY COST, ENERGY AND LAND REQUIREMENTS FOR SWITCHING  
TO NON-PRIORITY POLLUTANT CONTAINING CORROSION AND  
SCALE CONTROL CHEMICALS

	<u>Plant Size (MW)</u>		
	<u>25</u>	<u>100</u>	<u>1,000</u>
Capital Cost (\$)	None	None	None
Operation and Maintenance (\$/year)	1,800	5,200	36,000
Energy Requirements (kwh/year)	negligible	negligible	negligible
Land Requirements (acres)	negligible	negligible	negligible

Non-Water Quality Aspects. Switching to non-priority pollutant-containing, scale and corrosion control chemicals is not expected to have any non-water quality effects.

#### Replacement of Asbestos Cooling Tower Fill

The technology evaluated for the control of the discharge of asbestos in cooling tower blowdown is the replacement of the asbestos fill material with fill material of ceramic, PVC, or wood. The cost for asbestos cement fill replacement is extremely site-specific. Factors such as the current fill configuration, plant location, fill chosen for replacement, local labor wages and availability, proximity to appropriate asbestos fill disposal site and time available for fill replacement (cooling tower must be out of service) all affect the cost of fill replacement. The general range of the fill replacement costs can be estimated from repair work done by cooling tower manufacturers in the past. In one such case, the existing asbestos cement fill was damaged due to problems with the water chemistry of the recirculating water. This resulted in the leaching of calcium carbonate from the asbestos cement which brought about rapid fill deterioration. In another case, water freezing in the fill brought about serious damage. In both instances, complete fill replacement was necessary. Cost data for these two instances is summarized in table VIII-6.

The values which appear in the table serve as only general guidelines and may vary as much as 50 percent due to site-specific conditions. The costs include the labor cost for removal of the old fill, the cost of the new fill material which was of PVC or other asbestos-free composition, and the labor cost to install the new fill. They do not include the cost of disposal of the old asbestos cement fill. In the case of the 700-megawatt plant, some additional modifications to increase the thermal capacity of the tower were done at the time of the asbestos fill replacement. This brought the total cost of that project to about \$3.5 million while effecting about a 15 percent increase in thermal capacity.

Labor costs were estimated to run between one-third and one-half of the total replacement cost. This cost will vary depending on how the labor force is scheduled.

The operational costs of the tower may decrease upon asbestos fill replacement if the new fill and other tower modifications increased the tower efficiency. Yearly savings amounting from this are extremely site-specific.

The data indicate that costs in the range of \$1-9 million can be expected for asbestos fill replacement allowing for the +50 percent accuracy of the costs.

Non-Water Quality Aspects. The asbestos fill removed from the cooling tower may be considered a hazardous waste and require special disposal practices.

Table VIII-6  
 COOLING TOWER FILL REPLACEMENT COSTS

<u>Size of Plant Cooling Tower Was Servicing (MW)</u>	<u>Type of Fuel</u>	<u>Cost of Materials (Million Dollars 1979)</u>	<u>Cost of Labor (Million Dollars 1979)</u>	<u>Total Cost (Million Dollars 1979)</u>
700	Fossil	2	1	3
900	Nuclear	4	2	6

## ASH HANDLING

In response to comments received on the proposed regulation, the Agency has collected more data on the costs of fly ash disposal systems for new sources and reevaluated the costs of dry and wet ash handling and disposal. Dry ash handling and disposal costs were developed and compared with the costs of wet ash handling, including chemical precipitation for once-through sluicing.

The wet fly ash disposal system represents typical wet disposal methods utilized by existing plants in the industry. Costs of each system were developed from transport from ash hoppers through ultimate land disposal. Annualized costs were calculated for two generating capacities, 500 MW and 1,000 MW for both the wet and dry systems. Table VIII-7 shows the results of this comparison. Table VIII-8 presents the capital costs. The components of this evaluation and the basis for the costing are presented in the following sections.

The conclusion reached in this comparison is that, on an annualized cost basis, dry handling and disposal is less expensive than wet handling and disposal for fly ash from new plants of 500 mw or greater generating capacity.

While the Agency does not expect the cost differential between wet and dry systems to be as great for smaller plants, the costs appear to be comparable. However, the Agency did not develop additional data since construction of smaller new source plants is not anticipated.

### Fly Ash

Two treatment and control options for discharges from fly ash handling systems are costed in this section. They are:

1. Dry fly ash handling,
2. Once-through sluicing with chemical precipitation.

Use of dry fly ash handling includes dry vacuum and dry pressure pneumatic conveying systems.

The once-through sluicing system involves sluicing the ash to a pond with the sluice water passing through a chemical precipitation system prior to discharge. The information presented for the fly ash handling systems includes capital costs, operating and maintenance costs, energy requirements, and land requirements.

### Dry Fly Ash Handling

Both pneumatic vacuum conveying and pneumatic pressure conveying were evaluated. Technical descriptions of these two systems are presented in chapter VII. The costs of each system were addressed separately and then were combined into a "composite" cost for a typical plant by consideration of the number of plants using each technology.

Table VIII-7

Annualized Costs, Dry vs Wet Fly Ash Disposal  
(in \$1,000)

	Ash Collection	500 MW Ash Transport and Disposal	Total	Ash Collection	1,000 MW Ash Transport and Disposal	Total
Dry fly ash						
Capital (Amort.)	376	200	576	717	282	999
O&M	526	2,878	3,404	724	5,716	6,440
Energy	12	*	12	35	*	35
Land	3	18	21	4	24	28
TOTAL	917	3,096	4,013	1,480	6,022	7,502
Wet fly ash						
Capital (Amort.)	210	309	519	331	435	766
O&M	693	5,717	6,410	1,120	11,345	12,465
Energy	30	*	30	38	*	38
Land	1	24	25	2	42	44
TOTAL	934	6,050	6,985	1,491	11,822	13,313

\*Energy costs included in O&M costs.

Table VIII-8  
 Capital Costs for New Source Dry Fly Ash Handling Systems  
 (million dollars)

	<u>Plant Size (megawatts)</u>	
	<u>500</u>	<u>1000</u>
Ash Collection	3.54	6.76
Ash Transport/Disposal	<u>1.89</u>	<u>2.66</u>
Total	5.43	9.42



Dry fly ash handling capital costs are presented for these two technologies in terms of new plants and existing plants. Existing plants have an additional cost factor included for each case, that is, retrofit costs. Retrofit costs are presented as estimates because the costs are very site specific. In all cases except the chemical precipitation system, the retrofit cost will equal the cost to install the system. The chemical precipitation retrofit cost was estimated to be 10 percent of the installation cost. This cost reflects a number of items: labor to remove certain equipment, labor to reroute existing piping, and resulting downtime to install the new system. New plants will not bear such additional costs. The engineering and contingency estimate is 20 percent of the installed system with retrofit cost.

Capital Costs for Dry Fly Ash Handling Systems. The capital costs for dry fly ash disposal systems (table VIII-8) were calculated for the dry ash to a storage silo and wet ash conveyance to a pond, ash transport by truck one mile to the disposal site, and the disposal site. Ash collection equipment, except for the dry storage silo, was costed for an ash conveying rate equal to twice the actual ash generating rate. The silo was sized based on a 72-hour storage capacity. A factor of 2.5 times the total equipment cost was used to estimate the total installed cost of the system. The trucks for transport were costed at 100 percent operating factor. The ash disposal site was costed on the basis of a 60 percent coal ash generating rate for 30 years. In addition, for existing plants, the retrofit cost was estimated as equal to the cost for installing the equipment. Engineering and contingencies were estimated as 20 percent of the installed system costs with retrofit penalties.

Operating and Maintenance (O&M) Costs. Operating and maintenance costs for the dry fly ash disposal system include operating labor and three percent of capital equipment cost for maintenance and materials.

Energy Requirements. The energy requirements for either the vacuum or pressure systems involve, for the most part, the power requirements for the blowers. The range of power requirements for these blowers is from 38 KW to 180 KW at 150 TPH of fly ash. Other energy consuming equipment includes: silo aerators, unloaders, vent return line blowers, and silo heating coils. Table VIII-9 presents the annual energy requirements for the vacuum and pressure systems.

Land Requirements. The land requirements for the dry fly ash handling systems are given in table VIII-10. Land is required to contain the silo, blowers, piping, and the disposal site.

Non-Water Quality Aspects. Air Pollution--Application of dry fly ash handling may cause a higher dust loading in localized areas around the fly ash transport transfer points. A baghouse or other type of dust collection system will minimize such impacts. The costs of such dust control systems are included

Table VIII-9

Energy Requirements for New Source Dry Fly Ash Handling Systems  
(million kw-hr/year)

Plant Size (megawatts)

<u>500</u>	<u>1000</u>
0.340	0.980

Table VIII-10

Land Requirements for New Source Dry Fly Ash Handling Systems  
(acres)

Plant Size (megawatts)

<u>500</u>	<u>1000</u>
5.5	10.0

in the economic analysis. Dry fly ash landfill sites are subject to dusting problems, especially in arid regions. Until the site can be sealed with a cap or vegetative cover, watering to control dust may be required.

**Solid Waste**--No additional solid wastes are expected as a result of these regulations, including for dry fly ash transport and disposal. Further, fly ash, whether wet or dry, has a wide variety of industrial uses, such as fill or cover material, soil conditioners, roadway bases, drainage media, pozzolan, structural products, aggregate, grout, and metal extraction. Usage of this material eases disposal requirements.

**Consumptive Water Loss**--Less consumptive water loss is expected from dry fly ash handling and disposal than wet fly ash handling and disposal because of less overall water usage. The amounts of water used for dust control in dry fly ash systems should be no more than the amounts of water consumed in wet fly ash transport and disposal.

#### **Once-Through Discharge of Sluice Water After Chemical Precipitation**

The technology addressing this category is ponding of the fly ash with total discharge of sluice water after chemical precipitation. The system includes a clear pond and the addition of a chemical precipitation system. The costs and other requirements for this system are addressed in a manner similar to those for the dry fly ash handling systems. Similar assumptions were used for new and existing plants, pulverized and cyclone-fired boilers.

Capital Costs. The annual costs for new source wet fly ash handling system are presented in table VIII-7. Capital costs are presented in table VIII-11. The equipment upon which the capital costs were based are a clear pond to hold three years generation of fly ash at a 60 percent generating rate, piping, pumps, the equipment associated with the chemical precipitation system, and ash pile construction costs. Further description of this system can be found in Section VII.

Operating and Maintenance Costs. The O&M costs for the wet fly ash handling system are based on operation of a clear pond, piping, pumps and the chemical precipitation system.

Energy Requirements. The energy requirements for the wet fly ash disposal systems are presented in table VIII-12. The energy requirements are based on the energy used by the pumps, dispensers, and mixers for the chemical precipitation system.

Land Requirements. The land requirements for this system are presented in table VIII-13. The land requirement is based on a clear pond, piping from the sluice pumps to the pond, the land needed for the chemical precipitation system, and the land for the ash disposal pile.

Table VIII-11  
 Capital Costs for New Source Chemical Precipitation of  
 Once-Through Fly Ash Sluicing Systems  
 (million dollars)

Once-Through Sluicing  
 with Chemical Precipitation

	<u>Plant Capacity (MW)</u>	
	<u>500</u>	<u>1000</u>
Ash Collection	1.98	3.12
Ash Transport Disposal	<u>2.91</u>	<u>4.11</u>
Total	4.89	7.23

Table VIII-12

Energy Requirements for New Source Wet Chemical Precipitation  
of Once-Through Fly Ash Sluicing Systems

(million kilowatt-hours/year)

Once-Through Sluicing  
with Chemical Precipitation

Plant Capacity (MW)

<u>500</u>	<u>1000</u>
0.857	1.09

Table VIII-13

Land Requirements for New Source Chemical Precipitation  
of Once-Through Fly Ash Handling Systems

(acres)

Once-Through Sluicing  
with Chemical Precipitation

Plant Capacity (MW)

<u>500</u>	<u>1000</u>
4.5	8.7

Non-Water Quality Aspects. The use of chemical precipitation will result in a lime sludge which must be disposed of in a properly operated landfill. Proper landfill operation would insure against the possibility of leaching of material in the sludge which may otherwise enter groundwater.

### Bottom Ash

The discussion of bottom ash handling systems will include individual presentations of capital costs, operating and maintenance annual costs, energy requirements, and land requirements for 25, 100, and 1,000 MW 'typical' plants. The specific technologies associated with bottom ash handling are presented for complete recycle and partial recycle. The concept of complete recycle, as discussed in Section VII, involves the elimination of any direct discharge from the sluicing system water circuit.

Partial recycle allows for a continuous direct discharge from the sluice system with the remainder of the sluice stream returned to the main sluice pumps.

### Complete Recycle

The technologies addressed in the complete recycle category include hydrobin/dewatering bin systems, and ponding with recycle. Both technologies use slip stream softening. Costs for each of these technologies were composited in order to generate typical costs for a given plant installing complete recycle bottom ash handling. Both existing and new facilities are addressed. Existing plants have an additional cost factor included for each case, the retrofit costs. In all cases, the retrofit cost was assumed to equal the cost to install the system. This retrofit cost reflects a number of items: labor to remove certain existing equipment, labor to reroute existing piping, and resulting downtime to install the new system. New plants will not have to contend with this added cost.

Capital Cost. The capital costs are presented in table VIII-14 for the bottom ash handling systems which are considered for complete recycle. The dewatering bins system/slip stream softening capital costs are the summation of the dewatering bin system and slip stream softening system costs. The slip stream softening system cost is based on treatment of 10 percent of the ash sluicing stream. For existing plants, an installation factor of 2.5 times the equipment cost is used.

The retrofit "penalty" is considered to be equal to the cost of installation; the engineering and contingency are estimated at 20 percent of the installed system cost.

The second major system that was costed for a complete recycle scenario was ponding with recycle. The pond was assumed to be built one mile from the bottom ash sluice pumps. The slip stream softening system was assumed to treat 10 percent of the recycle stream and used the same equipment as presented above.

Table VIII-14

Capital Costs for Complete Recycle Bottom Ash Handling System  
(million dollars)

<u>System</u>	<u>Plant Capacity (MW)</u>		
	<u>25</u>	<u>500</u>	<u>1000</u>
Complete Recycle with Softening			
Existing	1.431	1.569	2.508
New	0.882	0.967	1.381

Operating and Maintenance Costs. Maintenance and materials items are different for hydrobin systems and recycle systems. For hydrobin systems, the annual maintenance and materials cost is estimated at two percent of the equipment cost. For recycle, this annual cost is assumed to be one percent of equipment cost. The slip stream softening O&M costs were calculated based on the amount of sluice water treated. A nominal ash disposal cost was assumed for the dewatering bin systems; this cost was \$1 per ton of bottom ash produced. This cost was based on the assumption that a plant would have to dispose of ash material regardless of any water discharge regulations. Thus, the difference in operating costs for disposal will be minimal. Costs for both systems were composited in order to generate typical costs for a given plant installing complete recycle bottom ash handling. The operation and maintenance costs are presented in table VIII-15.

Energy Requirements. The estimation of energy requirements is based on annual consumption of electricity. The requirements for the dewatering bin systems are based on the pumping requirements. Energy requirements for both systems were composited into typical energy requirements for a given plant installing complete recycle bottom ash handling. The energy requirements are presented in table VIII-16.

Land Requirements. The land requirements for a complete recycle system are given in table VIII-17. For recirculating systems, land requirements are for the clear pond and piping from the clear pond to the bottom ash hoppers. For the dewatering bin systems, land is required for the bins, tanks and pumps and piping.

Non-Water Quality Aspects. The use of complete recycle may require chemical softening of the recycle water. This would result in a lime sludge which must be disposed of in a landfill. If proper landfill operations are used, the potential problem of leaching into groundwater can be avoided.

#### Partial Recycle

The technologies addressed for bottom ash partial recycle systems are essentially the same as those presented for complete recycle. The major difference between the two scenarios is that the partial recycle bottom ash handling systems will not include a slip stream softening system.

The costs and other requirements were addressed in the same manner as for the complete recycle systems. Similar assumptions were utilized for addressing new and existing plants, pulverized and cyclone-fired boilers.

Capital Cost. The capital costs for partial recycle systems are presented in table VIII-18. The equipment upon which these costs are based, i.e., dewatering bins without slip stream softening and recirculation without slip stream softening system, may be found in the capital cost discussion for complete recycle systems.



Table VIII-15

OPERATING AND MAINTENANCE COSTS FOR COMPLETE RECYCLE  
BOTTOM ASH HANDLING SYSTEM

(million dollars/year)

<u>System</u>	<u>Plant Capacity (MW)</u>		
	<u>25</u>	<u>100</u>	<u>1000</u>
Complete Recycle with Softening			
Existing	0.440	0.445	0.561
New	0.440	0.445	0.535

Table VIII-16

ENERGY REQUIREMENTS FOR COMPLETE RECYCLE BOTTOM ASH  
HANDLING SYSTEM

(kwh/year)

<u>System</u>	<u>Plant Capacity (MW)</u>		
	<u>25</u>	<u>100</u>	<u>1000</u>
Complete Recycle with Softening			
Existing	1.19x10 <sup>5</sup>	1.96x10 <sup>5</sup>	1.48x10 <sup>6</sup>
New	1.12x10 <sup>5</sup>	1.53x10 <sup>5</sup>	1.04x10 <sup>6</sup>

Table VIII-17

LAND REQUIREMENTS FOR COMPLETE RECYCLE BOTTOM ASH  
HANDLING SYSTEM

(acres)

<u>System</u>	<u>Plant Capacity (MW)</u>		
	<u>25</u>	<u>100</u>	<u>1000</u>
Complete Recycle			
Existing	3.55	3.8	5.4
New	3.55	3.8	5.4

Table VIII-18

## CAPITAL COSTS FOR PARTIAL RECYCLE BOTTOM ASH HANDLING SYSTEM

(million dollars)

<u>System</u>	<u>Plant Capacity (MW)</u>		
	<u>25</u>	<u>100</u>	<u>1000</u>
Partial Recycle			
Existing	1.260	1.262	1.59
New	0.787	0.814	1.41

Operating and Maintenance Costs. The O&M annual costs estimated for the partial recycle systems are based on the same assumptions as for the complete recycle technologies. The slip stream softening O&M costs are omitted in the partial recycle cases. Table VIII-19 presents the O&M costs for the partial recycle systems.

Energy Requirements. The energy requirements for the partial recycle systems are based on the same assumptions as for the complete recycle technologies. The slip stream softening energy requirements are omitted in the partial recycle cases. Table VIII-20 presents the annual energy requirements for the partial recycle systems.

Land Requirements. The land requirements estimated for the partial recycle systems are based on the same assumptions as for the complete recycle technologies. The slip stream softening land requirements are omitted in the partial recycle cases. Table VIII-21 presents the land requirements for partial recycle systems.

Non-Water Quality Aspects. No nonwater quality impacts were identified as a result of requiring partial recirculation of sludge water.

#### LOW VOLUME-WASTES

The technology costed for the treatment of low-volume wastes is vapor compression evaporation (VCE). The sources of these wastes tend to be intermittent and batch in nature, requiring a basin to equalize the flow prior to treatment. The cost for diked impoundment of the water, assuming \$10,000 per impoundment acre, is shown in table VIII-22.

The installed battery limits costs for the VCE system are shown in table VIII-23. The system life is expected to be 30 years. The materials of construction for the system are titanium, stainless steel and special steel alloys.

The technologies costed for the disposal brine (evaporator bottoms) are evaporation ponds and spray drying. The capital and O&M costs for a typical diked clay-lined pond for 20 inches per year net evaporation are presented in table VIII-24. These costs are based on the following items:

- dirt and excavation cost--\$20,000 per acre, and
- clay costs and installation--\$20,000 per acre.

The capital costs, O&M costs, and energy and land requirements are presented in table VIII-25. No non-water quality impacts were identified as a result of implementing these technologies.

Table VIII-19

OPERATING AND MAINTENANCE COSTS FOR PARTIAL RECYCLE  
BOTTOM ASH HANDLING SYSTEM

(million dollars/year)

<u>System</u>	<u>Plant Capacity (MW)</u>		
	<u>25</u>	<u>100</u>	<u>1000</u>
Partial Recycle			
Existing	0.355	0.359	0.421
New	0.355	0.357	0.395

Table VIII-20

ANNUAL ENERGY REQUIREMENTS FOR PARTIAL RECYCLE BOTTOM ASH  
HANDLING SYSTEM

(kwh/year)

<u>System</u>	<u>Plant Capacity (MW)</u>		
	<u>25</u>	<u>100</u>	<u>1000</u>
Partial Recycle			
Existing	$0.99 \times 10^5$	$1.72 \times 10^5$	$1.42 \times 10^6$
New	$0.92 \times 10^5$	$1.30 \times 10^5$	$9.80 \times 10^5$

Table VIII-21

LAND REQUIREMENTS FOR PARTIAL RECYCLE BOTTOM ASH  
HANDLING SYSTEMS

(acres)

<u>System</u>	<u>Plant Capacity (MW)</u>		
	<u>25</u>	<u>100</u>	<u>1000</u>
Partial Recycle			
Existing	3.55	3.8	5.4
New	3.55	3.8	5.4

Table VIII-22

IMPOUNDMENT COST

	<u>Plant Size (MW)</u>		
	<u>25</u>	<u>100</u>	<u>1000</u>
Capital Cost (\$)	4,200	8,400	12,000
Operation and Maintenance (\$/year)	negligible	negligible	negligible
Land Requirements (acres)	0.35	0.7	1.0

Table VIII-23

## COST OF VAPOR COMPRESSION EVAPORATION SYSTEM

	<u>Plant Size (MW)</u>		
	<u>25</u>	<u>100</u>	<u>1000</u>
Installed Capital Cost (\$) <sup>a</sup>	1,140,000	2,040,000	2,880,000
Operation and Maintenance <sup>b</sup> (\$/year)	25,000	32,000	39,000
Energy Requirements (kwh/year)	1.6x10 <sup>6</sup>	3.2x10 <sup>6</sup>	4.8x10 <sup>6</sup>
Land Requirements (ft <sup>2</sup> )	4,000	4,000	4,000

a - The capital costs include 10 percent for engineering and 10 percent for contingencies.

b - The operation and maintenance costs assume continuous operation at a 55 capacity factor.

Table VIII-24

## COST OF EVAPORATION PONDING

	<u>Plant Size (MW)</u>		
	<u>25</u>	<u>100</u>	<u>1000</u>
Installed Capital Cost <sup>a</sup> (\$)	129,000	259,000	388,800
Operation and Maintenance (\$/year)	3,240	6,480	9,720
Energy Requirement (kwh/year)	negligible	negligible	negligible
Land Requirements (acres)	2.7	5.4	8.1

a - Cost of land not included.

## COAL PILE RUNOFF

For the treatment of coal pile runoff, two treatment and discharge options are presented:

- Option 1--equalization, pH adjustment, settling
- Option 2--equalization, chemical precipitation treatment, settling, pH adjustment.

The costs of Option 1 include impoundment (for equalization), a lime feed system and mixing tanks for pH adjustment, and a clarifier for settling.

The costs for the impoundment area include diking and containment around each coal pile and associated sumps and pumps and piping from runoff areas to impoundment area. The costs for land are not included. The cost of impoundment for pH adjustment is shown in table VIII-26.

The lime feed system employed for pH adjustment includes a storage silo, slaker, feeder, and lime slurry storage tank, instrumentation, electrical connections, piping and controls. The capital and O&M costs for pH adjustment are shown in table VIII-27. Rubber-lined steel mixing tanks are employed to accommodate wastes with a pH of less than 6. The capital and O&M costs as well as energy and land requirements for mixing are presented in table VIII-28.

The clarifier is assumed to have a 3-hour retention time. The costs of clarification are presented in table VIII-29.

The costs of Option 2 include impoundment for equalization, a lime feed system, mixing tank, and polymer feed system for chemical precipitation, a clarifier for settling and an acid feeder and mixing tank to readjust the pH within the range of 6 to 9. The equipment and system design, with the exception of the polymer feeder, acid feeder and final mixing tank, is essentially the same as for Option 1.

The costs for the impoundment area are the same as for Option 1 (refer to table VIII-26).

The costs for the lime feed system are presented in table VIII-30. The components of this system are the same as those for Option 1.

Two tanks are required for Option 2--one for precipitation and another for final pH adjustment with acid. The cost of mixing is therefore twice that of Option 1 (refer to table VIII-28).

The polymer feed system includes storage hoppers, chemical feeder, solution tanks, solution pumps, interconnecting piping, electrical connections and instrumentation. The costs of the polymer feed system are shown in table VIII-31.

The cost of clarification is identical to that of Option 1 (refer to table VIII-29).

Option 2 requires the use of an acid addition system to readjust the pH within the range of 6 to 9. The components of this system include a lined acid storage tank, two feed pumps, an acid pH control loop, and associated piping, electrical connections and instrumentation. The specific costs, including energy and land requirements, of the acid feed system are presented in table VIII-32.



Table VIII-25  
 COST OF SPRAY DRYING SYSTEM

	<u>Plant Size (MW)</u>		
	<u>25</u>	<u>100</u>	<u>1000</u>
Installed Capital Cost (\$)	600,000	648,000	744,000
Operation and Maintenance (\$/year)	25,000	25,800	27,400
Energy Requirements (kwh/yr)	3.7x10 <sup>6</sup>	7.4x10 <sup>6</sup>	1.0x10 <sup>7</sup>
Land Requirements (ft <sup>2</sup> )	800	800	800

Table VIII-26  
 COST OF IMPOUNDMENT FOR COAL PILE RUNOFF

	<u>Plant Size (MW)</u>		
	<u>25</u>	<u>100</u>	<u>1000</u>
Installed Capital Cost (\$)	4,500	4,500	9,000
Operation and Maintenance (\$)	negligible	negligible	negligible

Table VIII-27

## COST OF LIME FEED SYSTEM

	<u>Plant Size (MW)</u>		
	<u>25</u>	<u>100</u>	<u>1000</u>
Installed Capital Cost (\$)	91,200	168,000	258,000
Operation and Maintenance (\$/year)	3,800	7,000	11,500
Energy Requirements (kwh/yr)	3.6x10 <sup>4</sup>	3.6x10 <sup>4</sup>	3.6x10 <sup>4</sup>
Land Requirements (ft <sup>2</sup> )	5,000	5,000	5,000

Table VIII-28

## COST OF MIXING EQUIPMENT

	<u>Plant Size (MW)</u>		
	<u>25</u>	<u>100</u>	<u>1000</u>
Installed Capital Cost (\$)	43,200	60,000	76,300
Operation and Maintenance (\$/year)	1,500	1,600	1,700
Energy Requirements (kwh/yr)	1.3x10 <sup>3</sup>	3.3x10 <sup>3</sup>	6.5x10 <sup>3</sup>
Land Requirements (ft <sup>2</sup> )	2,000	2,000	2,000

Table VIII-29

## CLARIFICATION

	<u>Plant Size (MW)</u>		
	<u>25</u>	<u>100</u>	<u>1000</u>
Installed Capital Cost (\$)	120,000	156,000	186,000
Operation and Maintenance (\$/year)	2,100	2,400	2,700
Energy Requirements (kwh/yr)	1.3x10 <sup>3</sup>	3.3x10 <sup>3</sup>	6.5x10 <sup>3</sup>
Land Requirements (acres)	0.07	0.11	0.16

Table VIII-30

## COST FOR LIME FEED SYSTEM

	<u>Plant Size (MW)</u>		
	<u>25</u>	<u>100</u>	<u>1000</u>
Installed Capital Cost (\$)	91,200	168,000	258,000
Operation and Maintenance (\$/year)	3,800	7,000	11,500
Energy Requirements (kwh/yr)	3.6x10 <sup>4</sup>	3.6x10 <sup>4</sup>	3.6x10 <sup>4</sup>
Land Requirements (ft <sup>2</sup> )	5,000	5,000	5,000



## SECTION IX

### BEST AVAILABLE TECHNOLOGY ECONOMICALLY ACHIEVABLE GUIDELINES AND LIMITATIONS, NEW SOURCE PERFORMANCE STANDARDS, AND PRETREATMENT STANDARDS

The technical information presented in the previous sections was evaluated in light of the Water Pollution Control Act (P.L. 92-500) as amended and the Settlement Agreement in NRDC vs. Train 8 ERC 2120 (D.D.C. 1976), modified at 12 ERC 1833 (D.D.C. 1976). The Agency has determined, from the list of technology options, the best available technology economically achievable and new source performance standards for the following waste streams:

1. Once-Through Cooling Water
2. Cooling Tower Blowdown - Recirculating Cooling Water
3. Fly Ash Transport Water
4. Bottom Ash Transport Water
5. Low Volume Wastes
6. Chemical Metal Cleaning Wastes
7. Coal Pile Runoff

The following discussion summarizes the final regulations and the changes from the proposal. It first discusses requirements pertaining to all wastestreams. Each regulated wastestream is then discussed in the following order: once-through cooling water, cooling tower blowdown, fly ash transport water, bottom ash transport water, low volume wastes, chemical metal cleaning wastes, and coal pile runoff. For each wastestream, a discussion of the existing, proposed, and final limitations is presented along with an explanation of the changes from proposal. The discussion covers those previously promulgated limitations which are retained and the revisions being promulgated.

Additional background material may be found in the preamble to the proposed rule (45 F.R. 68328, Oct. 14, 1980) and the preamble to the final rule (47 F.R. 52290, Nov. 19, 1982).

## 1. All Wastewater Streams

### (a) Best Conventional Technology (BCT)

EPA proposed BCT limitations for TSS and oil and grease based on the "cost-reasonableness" test that was rejected in part in the American Paper Institute v. EPA case mentioned previously. Therefore, before promulgating BCT limitations, EPA must repropose them based on the revised BCT methodology proposed on October 29, 1982. See 49 FR 49176. In the interim, EPA is reserving BCT for the entire steam electric power industry. The Agency is also withdrawing the BAT limitations now in the Code of Federal Regulations for TSS and oil and grease since these pollutants are now regulated under BCT, not BAT.

### (b) Polychlorinated Biphenyl Compounds (PCBs)

The discharge of PCBs in any type of wastewaters from this industry is prohibited. This limitation was promulgated in 1974 and 1977 for BAT, NSPS, and PSES. EPA did not propose any changes in 1980 with the exception of adding PCB coverage for PSNS.

### (c) Commingling of Waste Streams

Where two or more different types of waste streams are combined for treatment or discharge, the total allowable discharge quantity of each pollutant may not exceed the sum of the allowable amounts for each individual type of wastewater. This requirement was promulgated in 1974 and EPA did not propose any changes in 1980.

### (d) Mass Limitations and Concentration Limitations

The existing and proposed regulations specified that permits were to be based on mass limitations to be calculated by multiplying flow by concentration. The final rule allows the permitting authority to establish either concentration or mass limits for any effluent limitation or standard, based on the concentrations specified in the regulations.

The Agency concluded that the use of mass-based limits in all circumstances is undesirable. The potentially large variations in flow make it difficult in some cases to choose a representative flow. Incorrect selection of a representative flow may result in limits that are either too stringent or too lenient.

Accordingly, the Agency decided to give the permit writer the authority to incorporate either concentration-based limits or mass-based limits into the permit, see e.g., §423.12(6)(11). Case-by-case determinations may be made, depending on the characteristics of the particular facility. Providing the permitting authority this flexibility will allow the choice of the most suitable limits for each plant, thereby promoting effluent reduction benefits.

These changes also apply to BPT permits since BPT permits may continue to be written for conventional pollutants until BCT limits are promulgated.

Where the permit contains concentration-based limits at the outfall for a combined waste treatment facility (e.g., ash ponds), the permit writer may establish numerical limits and monitoring on the individual, regulated waste stream prior to their mixing. See 40 CFR 122.63(i). The use of concentration based limits may necessitate the internal monitoring of several waste streams (i.e., cooling tower blowdown, metal cleaning wastes) to ensure that the pollutants of concern are not diluted by other waste streams where commingling occurs.

It should be noted that the "actual production" rule in 40 CFR §122.63(b)(2) does not apply to this industry.

(e) Pretreatment Standards for Existing Sources (PSES)

EPA is withdrawing the 1977 PSES requirement from oil and grease for all waste streams, as proposed in 1980. There was no PSNS for oil and grease. The 1977 PSES limited oil and grease based upon a maximum concentration of 100 mg/l. The Agency has determined that, for this industry, this level is no longer appropriate because oil and grease levels in raw wastestreams are most typically less than 100 mg/l. No lower level of control for oil and grease is being established for PSES because the Agency found that oil and grease at levels less than 100 mg/l do not interfere with or pass through POTWs.

2. Once-Through Cooling Water

(a) Previous Limitations

The 1974 BPT, BAT and NSPS limited free available chlorine (FAC) with mass limitations based upon 0.2 mg/l daily average concentration and 0.5 mg/l daily maximum concentration. Neither FAC or TRC could be discharged from any single unit for more than two hours per day and multi-unit chlorination was prohibited. There was an exception from the latter requirements if the utility could demonstrate to the permitting authority that the units in a particular location could not operate at or below this level of chlorination.

(b) Final Limitations

BAT and NSPS

EPA is promulgating a daily maximum limitation for total residual chlorine (TRC), also called total residual oxidants (TRO), based upon a concentration of 0.20 mg/l, applied at the final discharge point to the receiving body of water. Each individual generating unit is not allowed to discharge chlorine for more than two hours

per day, unless the discharger demonstrates to the permitting authority that a longer duration discharge is required for macroinvertebrate control. Simultaneous multi-unit chlorination of more than one generating unit is allowed.

The above limitation does not apply to plants with a total rated generating capacity of less than 25 megawatts. EPA is establishing BAT and NSPS equal to BPT for those plants.

#### PSES AND PSNS

There are no categorical pretreatment standards for once-through cooling water for PSES and PSNS, with the exception of the PCB prohibition. The PSES for oil and grease is withdrawn.

#### (c) Changes from Proposal and Rationale

##### (i) BAT and NSPS

For BAT and NSPS, EPA proposed to prohibit the discharge of total residual chlorine (TRC) unless facilities could demonstrate a need for chlorine to control condenser biofouling. Where such demonstrations were made, EPA proposed to limit the discharge to the minimum amount of TRC necessary to control biofouling, as determined by a chlorine minimization program. However, a maximum TRC limitation based upon a concentration of 0.14 mg/l at the point of discharge would have been established to be achieved either through chlorine minimization or dechlorination. In addition, EPA proposed to prohibit the discharge of TRC for more than two hours a day unless the plant could show that chlorination for a longer period was necessary for crustacean control. Finally, the existing prohibition (1974) on simultaneous dechlorination of generating units would have been withdrawn.

Commenters raised a variety of issues, leading EPA to change the proposal substantially with respect to the TRC limitation, the two-hour-a-day discharge requirement, and other requirements. These comments and the changes are discussed below.

#### Chlorine Limitation

Commenters stated that EPA has no authority to prohibit the use of chlorine or to require dischargers to conduct a chlorine minimization program. They also stated that the 0.14 mg/l maximum TRC limitation was not achievable by all sources. Some comments indicated a maximum 0.2 mg/l TRC concentration would be achievable; other comments said that BAT should equal BPT.



Under the proposed regulations all plants would have been required to reduce chlorine discharges to the maximum extent feasible. However, in reviewing the comments, the Agency concluded that the proposed approach deprived power plants of any flexibility in controlling chlorine discharges. Because it is the Agency's intent in the development of effluent limitations guidelines not to require reliance on only one technology where it can be reasonably avoided, the requirement that all plants institute chlorine minimization programs was deleted in the final regulation to provide more flexible alternatives to control chlorine discharges.

In assessing alternative approaches, the Agency initially considered requiring the maximum 0.14 mg/l TRC level but without requiring a mandatory chlorine minimization program. Based on the public comments, however, it appeared that the 0.14 mg/l limit would discourage use of chlorine minimization in favor of dechlorination. Industry commenters explained that many plants would still have to dechlorinate to meet the proposed limit even if they first minimized chlorine usage. If that were the case, it was stated the plants would rely on dechlorination exclusively to achieve the limits and not devote resources to a chlorine minimization program. However, if the final effluent limitations were based on 0.2 mg/l, the commenters generally believed that most plants could achieve the limit solely by chlorine minimization.

The Agency established a 0.20 mg/l based TRC limit because it is better, in the circumstances presented here, to establish a limitation that generally can be met without chemical treatment rather than one which entails both the addition of chlorine and its subsequent removal by the addition of other chemicals used to dechlorinate. Consequently, the Agency concluded that a mass limitation based on 0.20 mg/l TRC concentration would allow plants flexibility while encouraging reliance on the preferable technology option--chlorine minimization.

The Agency rejected the suggestion to promulgate BAT and NSPS to equal BPT. As described in Sections VII and VIII and in the Economic Analysis report, the use of chlorine minimization and/or dechlorination is technically and economically achievable. Compliance with the final regulations will remove 13.5 million pounds of chlorine annually, beginning in 1985. Further, the new limitations will control total residual chlorine in this wastestream; as discussed in Section VI, TRC is a better measure of chlorine toxicity than free available chlorine (FAC).

### Two Hour Chlorine Discharge Limit

The final rule also differs from the proposed rule on the two hour chlorine discharge limit. The Agency proposed to limit the discharge of chlorine to two hours per day per plant. The Agency also proposed to relax the prohibition in the 1974 regulations on simultaneous chlorination of generating units because of concern that some plants would not be able to adequately control biological growth on the condensers when limited to two hours per day of chlorine discharges for the entire facility.

The final regulations limit the duration of chlorine discharge to two hours per day, per generating unit. For example, a plant with four units is allowed to discharge chlorine for a maximum of eight hours per day. This change is consistent with the BPT requirement and was made in response to comments that the proposed change would have disrupted the established chlorination operating procedures required by BPT and that significant expenditure of resources would have been required to comply with the proposed BAT requirement. Many plants installed chlorination systems capable of chlorinating only one unit at a time to comply with the 1974 BPT chlorine requirements. The proposed new BAT may have required those plants with single discharge points serving multiple units to significantly enlarge their existing chlorination facilities. The Agency believes there are no compelling reasons to require this change for BAT or to set different limits for new sources.

Comments on the 1980 proposal supported the proposal to allow simultaneous chlorination. While the Agency deleted the proposed prohibition on the discharge of chlorine for more than two hours a day per plant, it has also decided to retain the proposal to allow simultaneous chlorination. The option to chlorinate generating units simultaneously will provide more operational flexibility to the discharger while maintaining the more stringent control of chlorine discharge with TRC limitations. For multi-unit discharges, these requirements will allow for natural chlorine demand to reduce chlorine discharge levels.

### Crustacean Control

EPA proposed to allow an exception to the two-hour-a-day chlorination limit if plants demonstrated that chlorination for a longer period of time was necessary for crustacean control. Because commenters pointed out that other macroinvertebrates besides crustaceans could impede the operation of cooling systems, EPA is broadening the exception to cover macroinvertebrates.

#### (1i) PSES/PSNS

There were no changes in PSES and PSNS from the proposed regulation. No known facilities discharge once-through cooling water to POTWs and none are known to be planned. These very high flow volumes would likely be unacceptable for discharge to any POTW.

### 3. Cooling Tower Blowdown

#### (a) Previous Limitations

The 1974 BPT limits control free available chlorine (FAC) with mass limitations based upon 0.2 mg/l daily average and 0.5 mg/l daily maximum concentrations. FAC and TRC discharges are limited to 2 hours per day per generating unit and simultaneous multi-unit chlorination is prohibited. The 1974 BAT and NSPS contain limitations equivalent to 1974 BPT, plus mass limitations for zinc, chromium, and phosphorous based upon concentrations of 1.0 mg/l, 0.2 mg/l, and 5.0 mg/l, respectively, and for PCBs. The 1974 PSNS contained no categorical pretreatment standards for cooling tower blowdown. The 1977 PSES limits oil and grease with a mass limitation based upon 100 mg/l and prohibits the discharge of PCBs.

#### (b) Final Limitations

##### BAT and NSPS

Chlorine. EPA is establishing BAT and NSPS limitations equivalent to the 1974 BAT and NSPS level of control. These limitations are based upon daily average and daily maximum concentrations for FAC of 0.2 mg/l and 0.5 mg/l, respectively.

Toxics. The discharge of one hundred twenty-four toxic pollutants is prohibited in detectable amounts from cooling tower discharges if the pollutants come from cooling tower maintenance chemicals. The discharger may demonstrate compliance with such limitations to the permitting authority by either routinely sampling and analyzing for the pollutants in the discharge, or providing mass balance calculations to demonstrate that use of particular maintenance chemicals will not result in detectable amounts of the toxic pollutants in the discharge. In addition, EPA is establishing a daily maximum BAT limitation and NSPS for chromium and zinc based upon concentrations of 0.2 mg/l and 1.0 mg/l, respectively.

The existing limitation for phosphorous is deleted.

##### PSES and PSNS

The final regulations prohibit or limit the 126 toxic pollutants as discussed above for BAT and NSPS. Oil and grease PSES are withdrawn.

#### (c) Changes from Proposal and Rationale

Chlorine. For BAT and NSPS, EPA proposed a limitation on TRC discharges based upon a maximum concentration of 0.14 mg/l times flow. A chlorine minimization program was not required. The Agency also proposed to prohibit all discharges of cooling tower

maintenance chemicals containing any of the 129 priority pollutants. Since then three of the 129 toxic pollutants have been "delisted." They are dichlorodifluoromethane, trichlorofluoromethane, and bis-chloromethyl ether. See 46 FR 2266; 46 FR 10723.

Public comments opposed the limitations on chlorine, stating that the proposed limit was unachievable and would not result in any environmental benefit. The Agency does not agree that the limit would be unachievable or result in no effluent reduction benefits; however, the Agency did re-examine the data pertaining to chlorine and found that the flow of this wastestream was less than one percent of the once-through cooling water flow. Further, less than 0.5 percent of the TRC which would be removed by regulating both cooling tower blowdown and once-through cooling water is attributable to cooling tower blowdown. The Agency concluded that the appropriate emphasis on chlorine control should be in the once-through cooling water waste stream and that BAT and NSPS for this waste stream should equal the previously promulgated BPT, BAT, and NSPS Limits. This will result in a cost savings of \$25 million in annual costs in 1985 and similar savings in future years.

Toxics. For BAT and NSPS, EPA proposed to prohibit any discharge of cooling tower maintenance chemical containing the 126 priority pollutants. The same prohibition was proposed for PSES and PSNS. Since equivalent pollutant removals are required for indirect and direct dischargers, EPA determined that a zero discharge pretreatment standard was the only means of assuring that no priority pollutant would pass through the POTW.

Commenters objected to the proposed zero discharge requirement for maintenance chemicals, raising concerns about the regulation of maintenance chemicals instead of priority pollutants and the means of measuring compliance with a zero discharge limit. In response, the Agency substituted "no detectable" for "zero discharge" and made clear that the limit applies to priority pollutants from maintenance chemicals, and not the chemicals themselves. EPA presently considers the nominal detection limit for most of the toxics to be 10 ug/l (i.e., 10 parts per billion). See, Sampling and Analysis Procedures for Screening of Industrial Effluents for Priority Pollutants, EPA, 1977.

Another concern expressed by commenters was that EPA did not account for those prohibited toxics that are present in new construction materials for cooling towers. For example, wooden supporting structures or other construction materials in new or rebuilt cooling towers may contain preservatives which contain trace amounts of certain of the toxic pollutants. These may leach for a period of time from contact with the cooling water. The Agency recognizes such situations. Thus, the prohibition in the final rule, as in the proposed rule, is applicable only to pollutants that are present in cooling tower blowdown as a result of cooling tower maintenance chemicals.

Commenters also expressed concern over potentially substantial compliance costs in analyzing for the 126 toxic pollutants in their discharges. The Agency agrees that the costs of routine compliance monitoring for the toxics could be quite expensive, and that there are alternative compliance mechanisms. Therefore, as an alternative to routine monitoring by sampling and analysis of effluents, the final rule provides for mass balance calculations to demonstrate compliance with the prohibition. For example, the discharger may provide the certified analytical contents of all biofouling and maintenance formulations used and engineering calculations demonstrating that any of the priority pollutants present in the maintenance chemicals would not be detectable in the cooling tower discharge using appropriate analytical methods. The permit issuing authority shall determine the appropriate approach for each circumstance.

Many commenters indicated that there are presently no acceptable substitutes for the use of chromium and zinc based cooling tower maintenance chemicals. The Agency agrees that adequate substitutes may not be presently available for many facilities. This is due in part to site specific conditions, including cooling water intake quality and the presence of construction materials susceptible to fouling and corrosion. Further, there is a potential for substitutes to be more toxic than the substances they are meant to replace. Therefore, the final BAT, NSPS and pretreatment standards allow for the discharge of chromium and zinc in cooling tower blowdown. The limitations are the same as those adopted in 1974 for BAT and are based upon pH adjustment, chemical precipitation, and sedimentation or filtration to remove precipitated metals.

No comments were received on the proposal to delete the phosphorous limitations; therefore, the final rule is the same as proposed in this report.

#### 4. Fly Ash Transport

##### (a) Previous Limitations

The 1974 BPT and BAT regulations covered PCBs and contained mass limitations for several pollutants based on the following concentrations: total suspended solids at 30 mg/l daily average and 100 mg/l daily maximum; oil and grease at 15 mg/l daily average and 20 mg/l daily maximum. The 1974 NSPS required zero discharge based upon use of dry fly ash transport. (This standard was remanded in 1976.) The 1974 PSNS contained no categorical pretreatment standards for the waste stream. The 1977 PSES contains a mass limit for oil and grease based upon a maximum concentration of 100 mg/l and a prohibition on the discharge of PCBs.

(b) Final Limitations

BAT and PSES

As discussed below, there are no BAT or PSES limitations for fly ash transport water, with the exception of the prohibition on discharges of PCBs. BAT limitations for conventional pollutants are withdrawn, as discussed earlier.

NSPS and PSNS

As discussed below, the final regulation prohibits the discharge of all pollutants from fly ash transport systems.

(c) Changes From Proposal and Rationale

EPA determined at proposal that the available data regarding the degree of toxic pollutant reduction to be achieved beyond BPT were too limited to support national limitations. Therefore, EPA did not propose BAT limitations or PSES for the priority pollutants. The Agency considered requiring a zero discharge option for existing sources but rejected it because the high cost of retrofitting does not justify the additional pollutant reductions beyond BPT. EPA did not receive any comments that it should establish BAT and revise PSES for the priority pollutants found in this wastestream. Therefore, no changes were made in the approach to BAT and PSES for the final rule. However, the Agency will be evaluating the level of control that is appropriate for conventional pollutants for BCT, as discussed previously.

For NSPS and PSNS, the coverage of the proposal was ambiguous. The preamble and development document indicated that EPA was prohibiting all discharges of fly ash water. 45 FR 68338. However, the proposed regulatory language only prohibited the discharge of copper, nickel, zinc, arsenic, and selenium. It did not cover the remaining toxic pollutants or conventional pollutants. Because the preamble correctly reflected EPA's intent, the final rule follows the preamble and not the proposed regulation. There is no practical difference between the two approaches since the fly ash technology option identified by EPA (dry fly ash transport systems) eliminates any discharge of wastewater whatsoever. The absence of any wastewater discharge means that all pollutants would be controlled, not just the five metals listed in the proposed regulation.

Comments were received concerning the proposed NSPS and PSNS but EPA did not make any changes as a result of them. The commenters stated that most new sources can meet the NSPS. However, they stated that EPA's cost estimates did not support the conclusion that the costs of dry and wet fly ash systems are not appreciably different. They also stated that EPA should provide a less stringent NSPS for those plants which could not meet the NSPS because of solid waste disposal constraints or air pollution problems.

EPA does not believe that less stringent NSPS or PSNS are warranted. Almost half of the existing plants already use dry fly ash systems. The Agency is unaware of any particular technical, air pollution, disposal or other problems they have encountered, or any reasons why all new plants cannot install dry fly ash systems. No specific examples or problems were given by the commenters. Further, as discussed in Section VI of this preamble, the costs for wet and dry fly ash systems are believed comparable.

Many existing plants are achieving zero discharge and new plants are at least as capable of implementing dry fly ash systems. The Agency estimates that a typical size new plant operating a dry fly ash handling system will reduce toxic metals discharges by approximately 4800 pounds per year beyond the BAT level of control. Nonwater quality environmental and energy impacts are considered reasonable in view of the effluent reduction that is achieved.

Finally, EPA has changed the definition of fly ash to include economizer ash where economizer ash is collected with fly ash. This change was not proposed; it is based on a comment which correctly pointed out that steam electric plants may collect economizer ash with either fly ash or bottom ash. The 1974 definition section, however, only included economizer ash in the bottom ash definition. Therefore, we are changing both the definition of fly ash and bottom ash to resolve this problem. EPA is not providing the opportunity for comment since the change was made in response to comments on the proposed regulation.

## 5. Bottom Ash Transport Water

### (a) Previous Limitations

The 1974 BPT regulations contain mass limitations for PCB and for several pollutants based on the following concentrations: total suspended solids of 30 mg/l daily average/100 mg/l daily maximum and oil and grease of 15 mg/l daily average/20 mg/l daily maximum. In addition, the pH is limited to within the range of 6.0 to 9.0. The 1974 BAT contains the same total suspended solids, oil and grease, pH and PCB limits as BPT, plus a recycle requirement of 12.5 cycles of bottom ash sluice water. The 1974 NSPS contains the same total suspended solids, oil and grease, and pH limits as BPT, plus a recycle requirement of 20 cycles of bottom ash sluice water. The 1974 PSNS do not contain any categorical pretreatment standards and the 1977 PSES contain a mass limitation for oil and grease based upon a maximum limitation of 100 mg/l, and prohibit the discharge of PCBs.

### (b) Final Limitations

#### BAT

The final regulations contain BAT limitations for PCBs. The BAT limitations for conventional pollutants are withdrawn for future coverage under BCT.

## NSPS

The final regulations contain limitations for total suspended solids, oil and grease, PCBs, and pH equal to the existing BPT. The 1974 recycle requirement for 20 cycles of bottom ash sluice water is withdrawn.

## PSES and PSNS

The final regulations contain categorical pretreatment requirements on PCBs for this wastestream. PSES for oil and grease is withdrawn.

### (c) Changes from Proposal and Rationale

EPA did not propose BAT limitations for the priority pollutants. Analysis of available wastewater sampling data did not indicate that a quantifiable reduction of toxic pollutants would be achieved by requiring technologies beyond the BPT level of control. These technologies include bottom ash recirculation systems and dry bottom ash transport systems. No comments were received objecting to the proposal; therefore, the final rule is the same as proposed. As explained before, EPA will examine conventional pollutant technology options in light of the revised BCT cost test.

For NSPS, PSES, and PSNS, no comments were received. Therefore, the proposed and final regulation are identical.

Finally, EPA is changing the definition of bottom ash for the reasons discussed in the previous section on fly ash.

## 6. Low Volume Wastes

### (a) Previous Limits

The existing BPT, BAT, and NSPS regulation establishes mass limitations for conventional pollutants: (1) total suspended solids based upon 30 mg/l daily average and 100 mg/l daily maximum concentrations; (2) oil and grease based upon 15 mg/l daily average and 20 mg/l daily maximum concentrations; and (3) pH between 6 and 9. There are no existing categorical pretreatment standards, with the exception of PCBs and oil and grease for PSES.

### (b) Final Limits

EPA did not propose new or revised limitations for this waste stream with the exception of substituting BCT for the control of conventional pollutants instead of BAT and withdrawing the PSES for oil and grease. BCT limitations are now reserved. However, EPA changed the definition of low volume waste to include boiler blowdown and is withdrawing the separate regulations for boiler blowdown.



(c) Changes from Proposal and Rationale

EPA proposed to include boiler blowdown as a low volume waste. This represents a change in coverage from the 1974 regulation. Information collected and analyzed by the Agency since 1974 led to the conclusion that there is no need to regulate boiler blowdown as a separate waste stream. Boiler blowdown is sufficiently similar in characteristics to the other specific types of low volume wastes. No commenters objected to the proposed change; therefore, the proposed and final rules are identical.

7. Metal Cleaning Wastes

(a) Previous Limits

"Metal cleaning wastes" is the generic name for a class of waste streams which results from the cleaning of boiler tubes, air preheater wash water, and boiler fireside wash water. This may be accomplished with either chemical cleaning solutions such as acids, degreasers, and metal complexers, or with plant service water only.

The 1974 BPT and BAT limitations and NSPS contain mass limitations for several pollutants based on the following concentrations: total suspended solids of 30 mg/l daily average and 100 mg/l daily maximum; oil and grease of 15 mg/l daily average and 20 mg/l daily maximum; total copper of 1.0 mg/l daily average and daily maximum; total iron 1.0 mg/l daily average and daily maximum pH is limited within the range of 6.0 to 9.0. The discharge of PCBs is prohibited.

The 1974 PSNS contains no categorical pretreatment standards for this waste stream. The 1977 PSES contains: a mass limitation for total copper based upon a maximum concentration of 1.0 mg/l; a mass limitation for oil and grease based upon a maximum concentration of 100 mg/l; and a prohibition on the discharge of PCBs.

(b) Final Limitations

Chemical Metal Cleaning Wastes

BAT

With one exception, BAT is equal to the 1974 regulations. The BAT limitations for conventional pollutants are withdrawn since BAT no longer applies to them.

NSPS

There are no changes from the 1974 NSPS.

## PSES and PSNS

The final PSES and PSNS contain a maximum concentration limitation of 1.0 mg/l for total copper, and prohibit the discharge of PCBs. The PSES for oil and grease is withdrawn.

## Non-Chemical Metal Cleaning Wastes

BAT, BCT, NSPS, PSES and PSNS for this waste stream are reserved for future rulemaking.

### (c) Changes From Proposal and Rationale

For chemical metal cleaning wastes, the final BAT, NSPS, PSES and PSNS are equivalent to the 1980 proposal. The 1980 proposal contained first time coverage of copper for PSNS and, for PSES, copper was changed from a mass-based limitation to a concentration limitation. Unlike the existing regulations and the 1980 proposal, however, the requirements do not cover non-chemical metal cleaning wastes.

In the preamble to the 1980 proposal, EPA explained that the existing requirements applied to all metal cleaning wastes, whether the wastes resulted from cleaning with chemical solutions or with water only. EPA rejected an earlier guidance statement which stated that wastes from metal cleaning with water would be considered "low volume" wastes. However, because many dischargers may have relied on this guidance, EPA proposed in 1980 to adopt the guidance for purposes of BPT and to change the BPT limitation to apply only to "chemical" metal cleaning wastes. See 45 FR 68333 (October 14, 1980) for a full discussion of the issue.

Commenters argued that EPA's clarified interpretation of the existing regulations was not supported by the record and would result in extremely high compliance costs. In response to the comments, the Agency examined the available data on waste characteristics of non-chemical metal cleaning wastes and the costs and economic impacts of controlling them. The data indicated that there was a definite potential for differences in concentration levels of inorganic pollutants depending on whether the plants were coal or oil-fired. Further, compliance with the existing effluent limitations and standards could be very costly and result in significant adverse economic impacts. However, the data were too limited for EPA to make a final decision.

EPA requested that the Utility Water Act Group provide specific, additional information. The data were submitted too late for the Agency to consider for this rulemaking. Consequently, EPA is reserving BAT, NSPS, PSES and PSNS for nonchemical metal cleaning wastes for future rulemaking.

EPA is withdrawing the proposal to change the BPT definition of metal cleaning wastes. However, until the Agency promulgates new limitations and standards, the previous guidance policy may continue to be applied in those specific cases in which it was applied in the past.

## 8. Coal Pile Runoff

### (a) Previous Limits

The BPT and BAT limitations and NSPS for coal pile runoff contain a maximum concentration limitation of 50 mg/l for total suspended solids and pH within the range 6.0 to 9.0. Any untreated overflow from a treatment facility sized to treat coal pile runoff which results from a 10-year, 24-hour event is not subject to these 1974 limitations. The 1974 PSNS and 1977 PSES for coal pile runoff contain no limitations for specific pollutants.

### (b) Final Limits

There are no changes to the existing regulations with the exception of the BAT limitations for conventional pollutants. The latter regulations are withdrawn since BAT limits no longer apply to conventional pollutants.

### (c) Changes From Proposal and Rationale

EPA did not propose any changes to the existing coal pile runoff regulations with the exception of proposing BCT limitations to replace BAT. As stated previously, the Agency is reserving BCT until we apply the revised BCT methodology to the technology options for controlling conventional pollutants.



## SECTION X

### ACKNOWLEDGEMENTS

Many individuals representing numerous agencies, institutes, organizations, universities, companies, and corporations have contributed material, time and energy to the production of this document. Because of the large number of individual contributors, only the organizations they represented will be mentioned.

The following acknowledgements for cooperation, assistance, data, advice, etc., are organized by type of organization.

Agencies--The following agencies and divisions of agencies contributed to the development of this document.

- EPA -
  1. All the regional offices
  2. Industrial and Environmental Research Labs--  
Research Triangle Park
  3. Industrial and Environmental Research Labs--  
Corvallis, Oregon
  4. Office of Research and Development
  5. Office of General Council
  6. Office of Planning and Evaluation
  7. Office of Enforcement
  8. Office of Analyses and Evaluation
  9. Monitoring and Data Support
  10. Criteria and Standards Division
  11. Office of Solid Wastes
  12. Environmental Monitoring and Support
  13. Environmental Research Lab--Duluth, Minnesota
  14. Office of Pesticide Program

Federal Power Commission  
Nuclear Regulatory Commission  
Oak Ridge National Laboratories

Several institutes and organizations, primarily representing the interests of the industry, were very helpful in providing data and various forms of technical assistance. These were:

Cooling Tower Institutes  
Edison Electric Institute  
Gulf South Research Institute  
Utility Water Act Group (UWAG)

Two state agencies, the State of California Resources Agency and the Michigan Department of Natural Resources, provided data and assistance to this effort. The University of Delaware is acknowledged for their assistance and data contributions.

Many private companies, primarily vendors doing business for electric utility companies, were helpful in providing equipment costs, engineering data and other assistance. These were (in alphabetical order):

- Allen Sherman Hoff Company
- Amertap Corporation
- ANDCO
- Betz Laboratories
- Carborundum
- Dow Chemical Company
- Drew Chemical Corporation
- Ecodyne
- INCRA
- Lockheed
- Mogul Corporation
- Olin Brass
- Research Cottrell
- Richardson
- Tetrattech, Inc.
- TRW
- United Conveyor

Many electric power companies were very cooperative in providing access to steam electric plants for various sampling and engineering studies. Many were also very cooperative in sharing data and other information on their facilities. Of particular assistance were (in alphabetical order):

- American Electric Power
- Appalachian Power Company
- Arizona Public Service Company
- Boston Edison
- Cincinnati Gas & Electric Company
- Colorado-Ute Power Company
- Commonwealth Edison
- Consumer Power Company
- Delmarva Power Company
- Georgia Power Company
- Gulf Power Company
- Long Island Lighting
- Natural Rural Electric

Nevada Power Company  
Northern States Power Company  
Pacific Power and Light  
Pennsylvania Power and Light Company  
Public Service Electric & Gas  
Southern California Edison  
Tampa Electric Company  
Tennessee Valley Authority  
Utah Power and Light  
Wisconsin Electric Power Company

## SECTION XI

### REFERENCES

#### SECTION III

1. "Development Document for Effluent Limitations Guidelines and New Source Performance Standards for the Steam Electric Power Generating Point Source Category," U.S. Environmental Protection Agency, EPA-4401/1-74-029-a, October 1974.
2. Telliard, William A., "Rationale for the Development of BAT Priority Pollutant Parameters," U.S. Environmental Protection Agency, May 24, 1977.
3. Natural Resources Defense Council, et al v Train, 8 E.R.C. 2120-2136 (D.C.D.C. 1976).
4. Appalachian Power Company, et al, v Train, 9 E.R.C. 1033-1056 (C.A.D.C. 1976).
5. "Standard Industrial Classification Manual," U.S. Office of Management and Budget, Washington, D.C., 1972.
6. "The Clean Water Act, Showing Changes Made by the 1977 Amendments and the 1978 Amendments to Sections 104 and 311," (33 U.S.C. 466 et seq.), 96th Congress, 1st Session, U.S. GPO, Washington, D.C., 1979.
7. "Sampling and Analysis Procedures for Screening of Industrial Effluents for Priority Pollutants," U.S. Environmental Protection Agency, April 1977
8. "Draft Economic Analysis for the Proposed Revision of Steam Electric Utility Industry Effluent Limitations Guidelines," U.S. Environmental Protection Agency, prepared by Temple, Barker, and Sloane, Inc., Lexington, Mass., August, 1980
9. "Inventory of Power Plants in the United States - April 1979", U.S. Department of Energy, Energy Information Administration, DOE/EIA - 0095(79), DIST CAT. UC - 97, U.S. Government Printing Office, Washington, D.C., 20402.
10. "Electric Utility Statistics" Public Power, Vol. 34, No. 1, pp. 32-74, 1976.

#### SECTION IV

1. "Development Document for Effluent Limitations Guidelines and New Source Performance Standards for the Steam Electric Power Generating Point Source Category," U.S. Environmental Protection Agency, EPA-4401/1-74-029-a, October 1974



## SECTION V

1. "Development Document for Effluent Limitations Guidelines and New Source Performance Standards for the Steam Electric Power Generating Point Source Category," U S Environmental Protection Agency, EPA-4401/1-74-029-a, October 1974
2. "Sampling and Analysis Procedures for Screening of Industrial Effluents for Priority Pollutants," U.S Environmental Protection Agency, April 1977.
3. White, George C., "Handbook of Chlorination: for Potable Water, Wastewater, Cooling Water, Industrial Processes, and Swimming Pools", Van Nostrand Reinhold Company, NY, 1972.
4. Lewis, Barbara-Ann G , "Asbestos in Cooling-Tower Waters," Argonne National Laboratory, Argonne, IL, December 1977
5. Warner, M E. and M. R. Lefevre, "Salt Water Natural Draft Cooling Tower Design Considerations," presented at the American Power Conference, Chicago, IL, April 1974.
6. Haggerty, D., and M. Lefevre, "The Growing Role of Natural Draft Cooling Towers in U.S Power Plants," Power Engineering, Vol. 80, No. 6, pp. 60-63, 1976.
7. Jolley, Robert L., et al., "Chlorination of Organics in Cooling Waters and Process Effluents," Proceedings of the Conference on the Environmental Impact of Water Chlorination, October 22-24, 1975.
8. Stevens, Alan A., et al., "Chlorination of Organics in Drinking Water," Proceedings of the Conference on the Environmental Impact of Water Chlorination, October 22-24, 1975.
9. Morris, J Carrell and B. Baum, "Precursors and Mechanisms of Haloform Formation in the Chlorination of Water Supplies," Harvard University, Cambridge, MA, undated.
10. Hubbs, S A., et al , "Trihalomethane Reduction at the Louisville Water Company," Louisville Water Company, Louisville, KY, undated.
11. Bean, Roger M., R. G Riley and P. W Ryan, "Investigation of Halogenated Components Formed from Chlorination of Estuarine Water," presented at the Conference on Water Chlorination: Environmental Impact and Health Effects, Gatlinburg, TN, October 31-November 4, 1977
12. Carpenter, James H. and C. A Smith, "Reactions in Chlorinated Seawater," Water Chlorination: Environmental

- Impact and Health Effects, Ann Arbor Science Publishers, Inc., Ann Arbor, Michigan, 1978.
13. "Principles of Industrial Water Treatment," Second Edition, Drew Chemical Corporation, Boonton, NJ, 1978.
  14. Alexander, James E., "Copper and Nickel Pickup in the Circulating Water Systems at Northport," New York Ocean Science Laboratory, Montauk, NY, March 1973.
  15. Popplewell, James M. and S. F. Hager, "Corrosion of Copper Alloys in Recirculating Cooling Tower Systems and its Effect on Copper in the Effluent," presented at the National Association of Corrosion Engineers Conference, San Francisco, CA, March 14-18, 1977
  16. Young, David R., et al., "Trace Metals in Coastal Power Plant Effluents," Southern California Coastal Water Research Project, El Segundo, CA, undated.
  17. Weidman, Jay G., Water Treatment Committee, Cooling Tower Institute, letter to John Lum, U.S. Environmental Protection Agency, April 6, 1977.
  18. "Steam: Its Generation and Use," 39th Edition, Babcock & Wilcox Company, New York, NY, 1978.
  19. "Ash Handling Systems and Suspended Solids in Ash Ponds," U.S. Environmental Protection Agency, prepared by Hittman Associates, Inc., Contract No. 68-01-4894, December 1978.
  20. Cox, Doye B., et al., "Characterization of Coal Pile Drainage," U S. Environmental Protection Agency, EPA-600/7-79-051, prepared by Tennessee Valley Authority, February 1979.
  21. Curtis, Robert, "Ash Handling File," Radian Corporation, McLean, VA, November 1979
  22. Miller, F. A., T. Y. J. Chu and R. J. Ruane, "Design of Monitoring Program for Ash Pond Effluents," U.S. Environmental Protection Agency, prepared by Tennessee Valley Authority, EPA-IAG-D8-E721, undated.
  23. NUS Corporation, "Treatability of Ash Settling Pond Effluents," Pittsburgh, PA, March 1979
  24. "Field Testing and Laboratory Studies for the Development of Effluent Standards for the Steam Electric Power Industry," U.S. Environmental Protection Agency, prepared by Radian Corporation, Contract No. 68-02-2608, August 1978.
  25. "Pollution Control Technology for Fossil Fuel-Fired Electric

Generating Stations, Section 3, Water Pollution Control," U.S. Environmental Protection Agency, prepared by Radian Corporation, Contract No 68-02-2008, March 1975

26. California Regional Water Quality Control Board, Santa Ana Region, "Variance from Effluent Guidelines Limitations for Steam Electric Power Generating Point Source Category," transmittal of August 12, 1976.
27. Rice, James K and Sheldon D. Strauss, "Water Pollution Control in Steam Plants," Power, Vol. 120, No 4, April 1977.
28. Halliburton Services, "Hydrochloric Acid Cleaning Service," Technical Data Sheet IC-12000(Rev), Duncan, Oklahoma.
29. Engle, J. P , "Cleaning Boiler Tubes Chemically," Chemical Engineering, Vol. 18, pp 154-158, 1971.
30. Greenburg, S , "Factors That Must Be Considered for Successful Chemical Cleaning as Experienced in Naval Boilers," Proceedings of the American Power Conference, Vol. 28, pp. 818-829, 1966.
31. Halliburton Services, "Curtain<sup>II</sup> Complexing Agent," Technical Data Sheet IC-12022(Rev), Duncan, Oklahoma.
32. "Handbook of Industrial Water Conditioning," Seventh Edition, Betz Laboratories, Trevose, PA, 1976.
33. Ellis, H. J., Public Service Company of New Hampshire, letter to Edward J. Conley, U.S. Environmental Protection Agency, Boston, MA, August 21, 1973
34. Klein, H. A., J. J Kurpen and W. G. Schuetzenduebel, "Cycle Cleanup for Supercritical Pressure Units," Proceedings of the American Power Conference, Vol. 27, pp. 756-773, 1965.
35. Halliburton Services, "The Citrosolv Process," Technical Data Sheet IC-12005(Rev.), Duncan, Oklahoma
36. Flynn, James P., Dow Industrial Service, letter to K. G. Budden, Hittman Associates, Inc., February 7, 1977.
37. Haller, W.A., et al , "Duke Power Company Ash Basin Equivalency Demonstration for Metal Cleaning Wastes," Proceedings of the American Power Conference, Vol. 39, pp 868-874, 1977.
38. Halliburton Services, "Hydroxyacetic/Formic Acid," Technical Data Sheet IC-12009(Rev), Duncan, Oklahoma
39. Reich, C. F. and D. B. Carroll, "A New Low Chloride

Inhibitor and Copper Complexing Agent for Sulfuric Acid Cleaning Solutions," Proceedings of the American Power Conference, Vol. 27, pp. 784-789, 1965.

40. Engle, J. P., "Chemical Cleaning of Feedwater Heaters," Paper No. 104, presented at the Corrosion Forum, Chicago, IL, March 4-8, 1974
41. Woldman, N. E., and R. C. Gibbons, eds , "Engineering Alloys," Fifth Edition, Van Nostrand Reinhold Company, New York, 1973.
42. Strumm, W., and J. J. Morgan, "Aquatic Chemistry: An Introduction Emphasizing Chemical Equilibria in Natural Waters," Wiley-Interscience, John Wiley & Sons, Inc., New York, 1970.
43. Ellis, H. J., Public Service Company of New Hampshire, letter to Edward Conley, U.S. Environmental Protection Agency, Boston, MA, August 21, 1973
44. Cox, Doye B , and R. J. Ruane, "Characterization of Coal Pile Drainage," Tennessee Valley Authority, EPA-IAG-D5-E-721, undated.
45. Anderson, William C , and Mark P. Youngstrom, "Coal Pile Leachate--Quantity and Quality Characteristics," ASCE, Journal of Environmental Engineering Division, Vol. 102, No. EE6, pp. 1239-1253, 1976.
46. Cox, Doye B., and R. J. Ruane, "Coal Pile Drainage," Tennessee Valley Authority, semi-annual progress report, July-December 1976.
47. Flora, H B., Ph.D (TN Valley Authority) to M. C Osborne, EPA, RTP, NC. re: Chlorinated organics study, once-through cooling system, letter. Chattanooga, TN, 4/24/79.
48. Hittman Associates, Inc. Boiler Chemical Cleaning Preliminary Draft Report, (EPA Contract No. 68-01-3501), Columbia Maryland, July 1977
49. Gregory, N., et al., "EPA Utility FGD Survey: February-March 1978," PEDCo Environmental, Inc., Cincinnati, OH, EPA Contract No. 67-01-4147, EPA 600/7-78-0516, June 1978.
50. Chu, T. J., R. J. Ruane and G R. Steiner, "Characteristics of Wastewater Discharges from Coal-fired Power Plants," paper presented at the 31st annual Purdue Industrial Waste Conference, West Lafayette, IN, May 1976
51. Sugarek, R. L. and T. G. Sipes, "Water Pollution Impact of Controlling Sulfur Dioxide Emissions from Coal-fired Steam Electric Generators," draft report, Radian Corporation,

Austin, TX, EPA Contract No 68-02-2608, October 1977

52. Leo, P P and J Rossoff, "The Solid Waste Impact of Controlling SO<sub>2</sub> Emissions from Coal-Fired Steam Generators," Vol 2-Technical Discussion, Aerospace Corporation, El Segundo, CA, EPA Contract No 68-01-3528, October 1977
53. Fling, R B , et al , "Disposal of Flue Gas Cleaning Wastes. EPA Shawnee Field Evaluation," Aerospace Corporation, Los Angeles, CA, EPA-ORD Contract No 68-02-1010, EPA 600/2-76-070, March 1976

#### SECTION VI

1. "The Clean Water Act, Showing Changes Made by the 1977 Amendments and the 1978 Amendments to Sections 104 and 311," (33 U S C. 466 et seq.), 96th Congress, 1st Session, U S GPO, Washington, D C , 1979
2. "Development Document for Effluent Limitations Guidelines and New Source Performance Standards for the Steam Electric Power Generating Point Source Category," U S Environmental Protection Agency, EPA-4401/1-74-029-a, October 1974
3. "Guidelines Establishing Test Procedures for the Analysis of Pollutants," Federal Register, Vol 38, No 199, pp 28758-28760, October 16, 1973
4. Paterson, Robert, "Corrosion and Scaling Control File. A Set of Notes and Phone Call Memos on Corrosion and Scaling Control," Radian Corporation, McLean, VA, August-November 1979
5. Paterson, Robert, "Non-Oxidizing Biocides File: A Set of Notes, Calculations and Vendor Contact Reports Concerning the Use of Non-Oxidizing Biocides," Radian Corporation, McLean, VA, August-November 1979

#### SECTION VII

1. White, George C , "Handbook of Chlorination. for Potable Water, Wastewater, Cooling Water, Industrial Processes, and Swimming Pools," Van Nostrand Reinhold Company, NY, 1972.
2. Ward, Daniel, "Chlorination, Chlorination-Alternatives File: A Set of Notes and Calculations Describing Cost Estimates," Radian Corporation, McLean, VA, October 1979.
3. Schumacher, P. D., and J W Lingle, "Chlorine Minimization Studies at the Valley and Oak Creek Power Plants," presented at the Condenser Biofouling Control Symposium, Atlanta, GA, March 1979

4. Rice, James K , "Chlorine Minimization Plan for Comanche Peak Steam Electric Station, Texas Utilities Generating Company, NPDES Permit TX0065854," Olney, MD, March 1979
5. Rice, James K., "Chlorine Minimization: . An Overview," Olney, MD, undated
6. Philadelphia Electric Company, "Condenser Chlorination Study - 1977/1978," Philadelphia, PA, October 1978
7. Moss, Robert, et al., "Chlorine Minimization/Optimization at one TVA Steam Plant," Tennessee Valley Authority, Chattanooga, TN, 1978.
8. Commonwealth Edison, "Chlorine Reduction Studies," Chicago, IL, December 1976
9. American Electric Power Service Corporation, "Indiana-Kentucky Electric Corporation, Clifty Creek Station. Chlorine Study Report," Vols. 1 and 2, Canton, OH, June 1978.
10. Duquesne Light Company, "Shippingport Atomic Power Station, NPDES Permit No PA 0001589. Chlorine Reduction Study," Pittsburg, PA, December 1978.
11. Lehr, John, "Summary Report on Chlorination Practices and Controls at Operating U S. Nuclear Power Plants," Draft Report, United States Nuclear Regulatory Commission, Washington, D.C , May 1978
12. Bernt, D S. and K. H Nordstrom, "Chlorine Reduction Study: High Bridge Generating Plant," Northern States Power Company, Minneapolis, MN, June 1978
13. Bernt, D. S., "Chlorine Reduction Study: Monticello Generating Plant," Northern States Power Company, Minneapolis, MN, June 1978
14. American Public Health Association, et al , "Standard Methods for the Examination of Water and Wastewater," Thirteenth Edition, APHA, AWWA, and WPCF, New York, 1971.
15. Betz Environmental Engineers, Inc , "Dechlorination," undated.
16. "Chlorination of Wastewater--Manual of Practice No. 4," Water Pollution Control Federation, Washington, D C , 1976
17. White, George C , "Chlorination and Dechlorination: A Scientific and Practical Approach," Journal AWWA, Vol. 60, No. 5, pp. 540-555, May 1968

- 18 Scheyer, K and G Houser, "Evaluation of Dechlorination for Total Residual Oxidants Removal," TRW, Inc , Redondo Beach, CA, Contract No 68-02-2613, November 1979
- 19 Schumacher, P D , "Test Results for Chemical Dechlorination Studies at the Valley Power Plant," Wisconsin Electric Power Company, Milwaukee, Wisconsin, June 1977
- 20 Pacific Gas and Electric Company, "Data and Letters Describing the Process of Dechlorination by Natural Chlorine Demand in a Recirculating Cooling Water System at California Power Plant," Transmitted to the California Regional Water Quality Control Board, Oakland, CA, June 20, 1977.
- 21 Gray, Harry J , and A. W. Speirs, "Chlorine Dioxide Use in Cooling Systems Using Sewage Effluent as Make-Up," presented at the Cooling Tower Institute Annual Meeting, Houston, Texas, January 23-25, 1978.
- 22 Yu, H. H S , G. A. Richardson and W H. Hedley, "Alternatives to Chlorination for Control of Condenser Tube Biofouling", Monsanto Research Corporation, Dayton, OH, EPA 600/7-77-030, March 1977
- 23 Ward, Daniel, "Chlorination, Chlorination-Alternatives File- A set of Notes and Calculations Describing ST Estimates," Radian Corporation, McLean, VA, October 1979.
24. Mills, Jack F , "Bromine Chloride, an Alternative to Chlorine for Treatment of Once-through Cooling Waters," presented at the Electric Power Research Institute Condenser Biofouling Control Symposium, Atlanta, GA, March 1979.
- 25 Bongers, Leonard H , et al , "Bromine Chloride--An Alternative Biofouling Control Agent for Cooling Water Treatment", presented at the Conference on Water Chlorination: Environmental Impact and Health Effects, Gatlinburg, TN, October 31-November 4, 1977.
26. Burton, D.T., and S L. Margrey, "Control of Fouling Organisms in Estuarine Cooling Water Systems by Chlorine and Bromine Chloride," Environmental Science & Technology, Vol 13, No. 6, pp. 684-689, June 1979.
- 27 Wackenhuth, E. C., and G Levine, "Experience in the Use of Bromine Chloride for Antifouling at Steam Electric Generating Stations," Biofouling Control Procedures, Pollution Engineering and Technology, Vol 5, Marcel Dekker, Inc , New York, 1977.
- 28 Union Carbide Corporation, "Ozonation Systems, Oxygen Production and Supply," "Ozonation Systems," and "LG Model Ozone Generators," pamphlets, New York, New York

29. Ozone Research & Equipment Corporation, "Ozonators: Industrial, Municipal, Process, Laboratory," Phoenix, AZ, undated.
30. Woodbridge, D. D., "Alternatives to Chlorination in Electric Power Plants," Hittman Associates, Inc , Columbia, MD, Contract No. 68-01-4894, undated
31. "Point Source Water Control Monitoring (sampling) Data Collection and Identification," Hittman Associates, Inc , Columbia, MD, Contract No 68-01-3501, Progress Report, October 1977.
32. Paterson, Robert, "Corrosion and Scaling Control File: A Set of Notes, Phone Call Memos on Corrosion and Scaling Control," Radian Corporation, McLean, VA, August-November 1979
33. Paterson, Robert, "Non-Oxidizing Biocides File. A Set of Notes, Calculations and Vendor Contract Reports Concerning the Use of Non-Oxidizing Biocides," Radian Corporation, McLean, VA, August-November 1979.
34. Weidman, Jay G., Cooling Tower Institute, letter to John Lum, U.S. Environmental Protection Agency, February 2, 1977
35. Sipp, J. R. and J. R Townsend, "Improving Condenser Cleanliness by Using a Dispersant to Supplement Chlorination at a Nuclear Power Plant," Presented at the Cooling Tower Institute Annual Meeting, January 23-25, 1978.
36. Allen-Sherman-Hoff Company, "A Primer on Ash Handling Systems," Malvern, PA, 1976.
37. Morrison, Ronald E., "Powerplants Ash: A New Mineral Resource," presented at the Fourth International Ash Utilization Symposium, St. Louis, Missouri, March 24-25, 1976
38. "Utilities Cash in on Fly Ash," Electrical World, Vol 185, No. 9, pp. 23-24, May 1, 1976
39. Curtis, Robert, "Ash Handling File: A Set of Notes and Calculations Describing the Costs Submitted to Temple, Barker and Sloane," Radian Corporation, McLean, VA, October 1979.
40. Allen-Sherman-Hoff Company, "A Primer on Ash Handling Systems," Malvern, PA, 1976.
41. "Process Design Manual for Suspended Solids Removal," U S. Environmental Protection Agency, EPA 625/1-75-003a, January 1975.



42. "Process Design Manual for Sludge Treatment Disposal," U S Environmental Protection Agency, EPA 625/1-74-006, October 1974
43. Culp, Russell L , G M Wesner, and G L Culp, "Handbook of Advanced Wastewater Treatment," Second Edition, Van Nostrand Reinhold Company, New Yor, 1978
44. Sorg, Thomas J , and G S Logsdon, "Treatment Technology to Meet the Interim Primary Drinking Water Regulations for Inorganics. Part 2," Journal American Water Works Association, pp 379-392, July 1978
45. Patterson, James W , "Wastewater Treatment Technology," Ann Arbor Science Publishers Inc., Ann Arbor, Michigan, 1975
46. "Development Document for Effluent Limitations Guidelines and New Source Performance Standards for the Steam Electric Power Generating Point Source Category," U S Environmental Protection Agency, EPA-4401/1-74/029-a, October 1974
47. Scott, M C., "Sulfide Process Removes Metals, Produces Disposable Sludge," Industrial Wastes, pp 34-39, July/August 1979
48. "Field Testing and Laboratory Studies for the Development of Effluent Standards for the Steam Electric Power Industry," U S Environmental Protection Agency, prepared by Radian Corporation, Contract No 68-02-2608, August 1978
49. Colley, J D., et al , "Assessment of Technology for Control of Toxic Effluents From the Electric Utility Industry," prepared by Radian Corporation for U S Environmental Protection Agency, Contract No 68-02-2608, December 1977
50. Resources Conservation Company, "Brine Concentration," Renton, WA, undated
51. Springer, Wayne E., Resources Conservation Company, letter to Thomas Emmel, Radian Corporation, August 14, 1979
52. "Scale-Free Vapor Compression Evaporation," U.S. Department of the Interior Washington, D C., undated.
53. Wackenhuth, E C , L. W Lamb and J P Engle, Use and Disposal of Boiler Cleaning Solvent, Power Engineering, November 1973
54. Jones, C. W., G. W Lewis and L D Martin, Disposal of Waste Ammoniacal Bromate and Ammonium Bifluoride Solutions by Evaporation, presented at the 37th Annual Meeting Internations Water Conference, Pittsburg, PA, October 26-28, 1976.

55. O'Neal, A. J., H. Cowmerd and D. J. Hassebroek, Experimental Incineration of Boiler Internal Cleaning Solvent at Long Island Lighting Company, Combustion, October 1976
56. Sisson, A. B. and G. V. Lee, Incineration Safely Disposes of Chemical Cleaning Solvents, presented at the American Power Conference, 1972.
57. Hittman Associates, Inc., Metal Cleaning Wastes File - A Collection of letters and phone contacts concerning Metal Cleaning Wastes, Their Cleanup and Disposal, Hittman Associates, Inc. 1976-1977.
58. Dow Industrial Service, ACR Process for Effective Chemical Cleaning...Incineration for Safe Effective Waste Disposal, Form No. 174-418-76, Dow Chemical, Midland, Michigan, 1976.
59. Engle, J. P. and J T Dillman, Chemical Cleaning of New Power Boilers, Power Engineering, 1967
60. Haller, W A , Ash Basin Equivalency Demonstration Duke Power Company, presented to the 39th Annual Meeting of the American Power Conference, Chicago, Illinois, April 19, 1977.
61. Chas. T. Main, Inc., Design Report Wastewater Treatment Facilities, New England Power Service Company, Chas T. Main, Inc., Boston, MA, 1975
62. Dascher, R.E , San Juan Station Water Management Program presented at the 39th Annual Meeting of the American Power Conference, Chicago, Illinois, April 19, 1977.
63. Kaercher, G. C. and R. M. Rosain, The Design of Wastewater Treatment Facilities for the Detroit Edison Company, Presented to the 39th Annual Meeting of the American Power Conference, Chicago, Illinois, April 19, 1977.
64. Martin, L. D and W. P. Banks, Electrochemical Investigation of Passivating Systems, presented at the 35th Annual Meeting International Water Conference, Pittsburg, PA, October 30 - November 1, 1974
65. Peltier, R. V. and J. E Brennan, Design and Implementation of the San Diego Gas & Electric Company Wastewater Treatment System, presented at the 39th Annual Meeting of the American Power Conference, Chicago, Illinois, April 19, 1977
66. Kuppusamy, N , Copper removal from Power Plant Boiler-Cleaning Waste, Industrial Waste, 23(2), 43-45, March 1977
67. Feigenbaum, H. M., Removing Heavy Metals in Textile Waste,

Industrial Wastes, 11 (11) pp 32-34, 1977

- 68 "Steam: Its Generation and Use," 39th Edition, Babcock & Wilcox Company, New York, NY, 1978
- 69 Strumm, W and J J. Morgan, Aquatic Chemistry, Wiley-Interscience, John Wiley & Sons, Inc , New York, NY, 1970

SECTION IX

1. "Development Document for Effluent Limitations Guidelines and New Source Performance Standards for the Steam Electric Power Generating Point Source Category," U S Environmental Protection Agency, EPA-4401/1-74-029-a, October 1974

## SECTION XII

### GLOSSARY

This section is an alphabetical listing of technical terms (with definitions) used in this document which may not be familiar to the reader.

#### Absolute Pressure

The total force per unit area measured above absolute vacuum as a reference. Standard atmospheric pressure is 101,326 N/m<sup>2</sup> (14.696 psi) above absolute vacuum (zero pressure absolute).

#### Absolute Temperature

The temperature measured from a zero at which all molecular activity ceases. The volume of an ideal gas is directly proportional to its absolute temperature. It is measured in +K (+R) corresponding to +C + 273 (+F + 459).

#### Acid

A substance which dissolves in water with the formation of hydrogen ion. A substance containing hydrogen which may be displaced by metals to form salts.

#### Acid-Washed Activated Carbon

Carbon which has been contacted with an acid solution with the purpose of dissolving ash in the activated carbon.

#### Acidity

The quantitative capacity of aqueous solutions to react with hydroxyl ions (OH<sup>-</sup>). The condition of a water solution having a pH of less than 7.

#### Acre-Foot

(1)

(2)

#### Activated Carbon

Carbon which is treated by high-temperature heating with steam or carbon dioxide producing an internal porous particle structure.

### Adsorption

The adhesion of an extremely thin layer of molecules (of gas, liquid) to the surfaces of solids (granular activated carbons for instance) or liquids with which they are in contact.

### Adsorption Isotherms (Activated Carbon)

A measurement of adsorption determined at a constant temperature by varying the amount of carbon used or the concentration impurity in contact with the carbon.

### Advanced Waste Treatment

Any treatment method or process employed following biological treatment (1) to increase the removal of pollution load, (2) to remove substances which may be deleterious to receiving waters or the environment, (3) to produce a high-quality effluent suitable for reuse in any specific manner or for discharge under critical conditions. The term tertiary treatment is commonly used to denote advanced waste treatment methods.

### Aerated Pond

A natural or artificial wastewater treatment pond in which mechanical or diffused air aeration is used to supplement the oxygen supply.

### Aeration

The bringing about of intimate contact between air and liquid by one of the following methods; spraying the liquid in the air, bubbling air through the liquid (diffused aeration), agitation of the liquid to promote surface absorption of air (mechanical aeration).

### Agglomeration

The coalescence of dispersed suspended matter into larger flocs or particles which settle more rapidly.

### Algicide

Chemicals used to kill or otherwise control phytoplankton (algae) in water.

### Alkaline

The condition of a water solution having a pH concentration greater than 7.0 and having the properties of a base.

### Alkalinity

The capacity of water to neutralize acids, a property imparted by the water's content of carbonates, bicarbonates, hydroxides, and occasionally borates, silicates, and phosphates. It is expressed in milligrams per liter or equivalent calcium carbonate.

### Anion

The charged particle in a solution of an electrolyte which carries a negative charge.

### Anion Exchange Process

The reversible exchange of negative ions between functional groups of the ion exchange medium and the solution in which the solid is immersed. Used as a wastewater treatment process for removal of anions, e.g., carbonate.

### Anionic Surfactant

An ionic type of surface-active substance that has been widely used in cleaning products. The hydrophilic group of these surfactants carries a negative charge in washing solution.

### Anthracite

A hard natural coal of high luster which contains little volatile matter.

### Apparent Density (Activated Carbon)

The weight per unit volume of activated carbon.

### Approach Temperature

The difference between the exit temperature of water from a cooling tower and the wet bulb temperature of the air.

### Aquifer

A subsurface geological structure that contains water.

### Ash

The solid residue following combustion as a fuel.

### Ash Sluice

The transport of solid residue ash by water flow in a conduit.

### Backwashing

The process of cleaning a rapid sand or mechanical filter by reversing the flow of water.

### Baffles

Deflector vanes, guides, grids, gratings, or similar devices constructed or placed in flowing water or sewage to (1) check or effect a more uniform distribution of velocities; (2) absorb energy; (3) divert, guide, or agitate the liquids, and (4) check eddy currents.

### Bag Filter

A fabric type filter in which dust laden gas is made to pass through woven fabric to remove the particulate matter.

### Banks, Sludge

Accumulations on the bed of a waterway of deposits of solids of sewage or industrial waste origin.

### Base

A compound which dissolves in water to yield hydroxyl ions (OH<sup>-</sup>).

### Base-Load Unit

An electric generating facility operating continuously at a constant output with little hourly or daily fluctuation.

### Bed Depth (Activated Carbon)

The amount of carbon expressed in length units which is parallel to the flow of the stream and through which the stream must pass.

### Bioassay

An assay method using a change in biological activity as a qualitative or quantitative means of analyzing a material response to industrial wastes and other wastewaters by using viable organisms or live fish as test organisms.

### Biochemical Oxygen Demand (BOD)

(1) The quantity of oxygen used in the biochemical oxidation of organic matter in a specified time, at a specified temperature, and under specified conditions.

(2) Standard test used in accessing wastewater strength.

### Biocides

Chemical agents with the capacity to kill biological life forms. Bactericides, insecticides, pesticides, etc., are examples.

### Biodegradable

The part of organic matter which can be oxidized by bioprocesses, biodegradable detergents, food wastes, animal manure.

### Biological Wastewater Treatment

Forms of wastewater treatment in which bacterial or biochemical action is intensified to stabilize, oxidize, and nitrify the unstable organic matter present. Intermittent sand filters, contact beds, trickling filters, and activated sludge process are examples.

### Bituminous

A coal of intermediate hardness containing between 50 and 92 percent carbon.

### Blowdown

A portion of water in a closed system which is removed or discharged in order to prevent a buildup of dissolved solids.

### Boiler

A device in which a liquid is converted into its vapor state by the action of heat. In the steam electric generating industry, the equipment which converts water into steam.

### Boiler Feedwater

The water supplied to a boiler to be converted into steam.

### Boiler Fireside

The surface at boiler heat exchange elements exposed to the hot combustion products.

### Boiler Scale

An incrustation of salts deposited on the waterside of a boiler as a result of the evaporation of water.



### Boiler Tubes

Tubes contained in a boiler through which water passes during its conversion into steam.

### Bottom Ash

The solid residue left from the combustion of a fuel which falls to the bottom of the combustion chamber.

### Brackish Water

Water having a dissolved solids content between that of fresh water and that of sea water, generally from 1,000 to 10,000 mg per liter.

### Brine

Water saturated with a salt.

### Buffer

Any of certain combinations of chemicals used to stabilize the pH values or alkalinities of solutions.

### Cake, Sludge

The material resulting from air drying or dewatering sludge (usually forkable or spadable).

### Calibration

The determination, checking or rectifying of the graduation of any instrument given quantitative measurements.

### Capacity Factor

The ratio of energy actually produced to that which would have been produced in the same period had the unit been operated continuously at rated capacity.

### Carbonate Hardness

Hardness of water caused by the presence of carbonates and bicarbonates of calcium and magnesium.

### Carbon Column A

A column filled with granular activated carbon whose primary function is the preferential adsorption of a particular type or types of molecules.

### Catalyst

A substance which accelerates or retards a chemical reaction without undergoing any permanent changes.

### Cation

The charged particles in solution of an electrolyte which are positively charged.

### Cation Exchange Process

The reversible exchange of positive ions between functional groups of the ion exchange medium and the solution in which the solid is immersed. Used as a wastewater treatment process for removal of cations, e.g., calcium.

### Cationic Surfactant

A surfactant in which the hydrophilic groups are positively charged; usually a quaternary ammonium salt such as cetyl trimethyl ammonium bromide (CeTAB),  $C_{16}H_{33}N + (CH_3)_3 Br$ . Cationic surfactants, as a class, are poor cleaners but exhibit remarkable disinfectant properties.

### Chelating Agents

A chelating agent can attach itself to central metallic atom so as to form a heterocyclic ring. Used to make ion exchange more selective for specific metal ions such as nickel, copper, and cobalt.

### Chemical Analysis

The use of a standard chemical analytical procedure to determine the concentration of a specific pollutant in a wastewater sample.

### Chemical Coagulation

The destabilization and initial aggregation of colloidal and finely divided suspended matter by the addition of a floc-forming chemical.

### Chemical Oxygen Demand (COD)

A specific test to measure the amount of oxygen required for the complete oxidation of all organic and inorganic matter in a water sample which is susceptible to oxidation by a strong chemical oxidant.

### Chemical Precipitation

- (1) Precipitation induced by addition of chemicals.
- (2) The process of softening water by the addition of lime and soda ash as the precipitants.

### Chemisorption

Adsorption where the forces holding the adsorbate to the adsorbent are chemical (valance) instead of physical (van der Waals).

### Chlorination

The application of chlorine to water or wastewater, generally for the purpose of disinfection but frequently for accomplishing other biological or chemical results.

### Chlorination Break Point

The application of chlorine to water, sewage, or industrial waste containing free ammonia to the point where free residual chlorine is available.

### Chlorination, Free Residual

The application of chlorine to water, sewage, or industrial wastes to produce directly or through the destruction of ammonia, or of certain organic nitrogenous compounds, a free available chlorine residual.

### Chlorine, Available

A term used in rating chlorinated lime and hypochlorites as to their total oxidizing power. Also, a term formerly applied to residual chlorine; now obsolete.

### Chlorine, Combined Available Residual

That portion of the total residual chlorine remaining in water, sewage, or industrial wastes at the end of specified contact period which will react chemically and biologically as chloramines or organic chloramines.

### Chlorine Demand

The quantity of chlorine absorbed by wastewater (or water) in a given length of time.

### Chlorine, Total Residual

Free residual plus combined residual.

### Clorite, High-Test Hypo

A combination of lime and chlorine consisting largely of calcium hypochloride.

### Chlorite, Sodium Hypo

A water solution of sodium hydroxide and chlorine in which sodium hypochlorite is the essential ingredient.

### Circulating Water Pumps

Pumps which deliver cooling water to the condensers of a powerplant.

### Circulating Water System

A system which conveys cooling water from its source to the main condensers and then to the point of discharge. Synonymous with cooling water system.

### Clarification

A process for the removal of suspended matter from a water solution.

### Clarifier

A basin in which water flows at a low velocity to allow settling of suspended matter.

### Colloids

A finely divided dispersion of one material called the "dispersed phase" (solid); in another material which is called the "dispersion medium" (liquid). Normally negatively charged.

### Closed Circulating Water System

A system which passes water through the condensers then through an artificial cooling device and keeps recycling it.

### Coal Pile Drainage

Runoff from the coal pile as a result of rainfall.

### Condensate Polisher

An ion exchanger used to adsorb minute quantities of cations and anions present in condensate as a result of corrosion and erosion of metallic surfaces.

### Condenser

A device for converting a vapor into its liquid phase.

### Construction

Any placement, assembly, or installation of facilities or equipment (including contractual obligations to purchase such facilities or equipment) at the premises where the equipment will be used, including preparation work at the premises.

### Convection

The heat transfer mechanism arising from the motion of a fluid.

### Composite Wastewater Sample

A combination of individual samples of water or wastewater taken at selected intervals, generally hourly for some specified period, to minimize the effect of the variability of the individual sample. Individual samples may have equal volume or may be roughly proportioned to the flow at time of sampling.

### Concentration, Hydrogen Ion

The weight of hydrogen ions in grams per liter of solution. Commonly expressed as the pH value that represents the logarithms of the reciprocal of the hydrogen ion concentration.

### Cooling Canal

A canal in which warm water enters at one end, is cooled by contact with air, and is discharged at the other end.

### Cooling Tower

A configured heat exchange device which transfers rejected heat from circulating water to the atmosphere.

### Cooling Tower Basin

A basin located at the bottom of a cooling tower for collecting the falling water.

### Cooling Water System

See Circulating Water System.

### Corrosion Inhibitor

A chemical agent which slows down or prohibits a corrosion reaction.

### Counterflow

A process in which two mediae flow through a system in opposite directions.

### Critical Point

The temperature and pressure conditions at which the saturated liquid and saturated vapor states of a fluid are identical. For water-steam, these conditions are 3208.2 psia and 705.47 +F.

### Cycling Plant

A generating facility which operates between peak load and base load conditions.

### Cyclone Furnace

A water-cooled horizontal cylinder in which fuel is fired, heat is released at extremely high rates, and combustion is completed. The hot gases are then ejected into the main furnace. The fuel and combustion air enter tangentially imparting a whirling motion to the burning fuel, hence the name Cyclone Furnace. Molten slag forms on the cylinder walls and flows off for removal.

### Data

Records of observations and measurements of physical facts, occurrences, and conditions reduced to written, graphical, or tabular form.

### Data Correlation

The process of the conversion of reduced data into a functional relationship and the development of the significance of both the data and the relationship for the purpose of process evaluation.

### Data Reduction

The process for the conversion of raw field data into a systematic flow which assists in recognizing errors, omissions, and the overall data quality.

### Data Significance

The result of the statistical analysis of a data group or bank wherein the value or significance of the data receives a thorough appraisal.

### Deaeration

A process by which dissolved air and oxygen are stripped from water either by physical or chemical methods.

### Deaerator

A device for the removal of oxygen, carbon dioxide, and other gases from water.

### Dechlorination Process

A process by which excess chlorine is removed from water to a desired level, e.g., 0.1 mg/l maximum limit. Usually accomplished by passage through carbon beds or by aeration at a suitable pH.

### Degasification

The removal of a gas from a liquid.

### Deionizer

A process for treating water by removal of cations and anions.

### Demineralizer

See Deionizer.

### Demister

A device for trapping liquid entrainment from gas or vapor streams.

### Detention Time

The time allowed for solids to collect in a settling tank. Theoretically, detention time is equal to the volume of the tank divided by the flow rate. The actual detention time is determined by the purpose of the tank. Also, the design resident time in a tank or reaction vessel which allows a chemical reaction to go to completion, such as the reduction of chromium +6 or the destruction of cyanide.

### Dewater

To remove a portion of the water from a sludge or a slurry.

### Dew Point

The temperature of a gas-vapor mixture at which the vapor condenses when it is cooled at constant humidity.

### Diatomaceous Earth

A filter medium used for filtration of effluents from secondary and tertiary treatments, particularly when a very high grade of water for reuse in certain industrial purposes is required. Also used as an adsorbent for oils and oily emulsions in some wastewater treatment designs.

### Diesel

An internal combustion engine in which the temperature at the end of the compression is such that combustion is initiated without external ignition.

### Discharge

To release or vent.

### Discharge Pipe

A section of pipe or conduit from the condenser discharge to the point of discharge into receiving waters or cooling device.

### Dissolved Solids

Theoretically, the anhydrous residues of the dissolved constituents in water. Actually, the term is defined by the method used in determination. In water and wastewater treatment, the Standard Methods tests are used.



### Diurnal Flow Curve

A curve which depicts flow distribution over the 24-hour day.

### Drift

Entrained water carried from a cooling device by the exhaust air.

### Dry Bottom Furnace

Refers to a furnace in which the ash leaves the boiler bottom as a solid (as opposed to a molten slag).

### Dry Tower

A cooling tower in which the fluid to be cooled flows within a closed system which transfers heat to the environment using finned or extended surfaces.

### Dry Well

A dry compartment of a pump structure at or below pumping level where pumps are located.

### Economizer

A heat exchanger which uses the heat of combustion gases to raise the boiler feedwater temperature before the feedwater enters the boiler.

### Economizer Ash

Carryover ash from the boiler which due to its size and weight, settles in a hopper below the economizer.

### Effluent

- (1) A liquid which flows out of a containing space.
- (2) Sewage, water or other liquid, partially or, as the case may be, flowing out of a reservoir basin, treatment plant, or part thereof.

### Electrostatic Precipitator

A device for removing particles from a stream of gas based on the principle that these particles carry electrostatic charges and can therefore be attracted to an electrode by imposing a potential across the stream of gas.

### Evaporation

The process by which a liquid becomes a vapor.

### Evaporator

A device which converts a liquid into a vapor by the addition of heat.

### Feedwater Heater

Heat exchangers in which boiler feedwater is preheated by steam extracted from the turbine.

### Filter Bed

A device for removing suspended solids from water, consisting of granular material placed in a layer(s) and capable of being cleaned hydraulically by reversing the direction of the flow.

### Filter, High-Rate

A trickling filter operated at a high average daily dosing rate. All between 10 and 30 mgd/acre, sometimes including recirculation of effluent.

### Filter, Intermittent

A natural or artificial bed of sand or other fine-grained material to the surface of which sewage is intermittently added in flooding doses and through which it passes, opportunity being given for filtration and the maintenance of aerobic conditions.

### Filter, Low-Rate

A trickling filter designed to receive a small load of BOD per unit volume of filtering material and to have a low dosage rate per unit of surface area (usually 1 to 4 mgd/acre). Also called standard rate filter.

### Filter, Rapid Sand

A filter for the purification of water where water which has been previously treated, usually by coagulation and sedimentation, is passed downward through a filtering medium consisting of a layer of sand or prepared anthracite coal or other suitable material, usually from 24 to 30 inches thick and resting on a supporting bed of gravel or a porous median such as carborundum. The filtrate is removed by an underdrain system. The filter is cleaned periodically by reversing the flow of the water upward through the filtering medium; sometimes supplemented by mechanical or air agitation during backwashing to remove mud and other impurities that are lodged in the sand.

### Filter, Trickling

A filter consisting of a cylindrical drum mounted on a horizontal axis, covered with a filter cloth revolving with a partial submergence in liquid. A vacuum is maintained under the cloth for the larger part of a revolution to extract moisture and the cake is scraped off continuously.

### Filtration

The process of passing a liquid through a filtering medium for the removal of suspended or colloidal matter.

### Fireside Cleaning

Cleaning of the outside surface of boiler tubes and combustion chamber refractories to remove deposits formed during the combustions.

### Floc

A very fine, fluffy mass formed by the aggregation of fine suspended particles.

### Flocculator

An apparatus designed for the formation of floc in water or sewage.

### Flocculation

In water and wastewater treatment, the agglomeration of colloidal and finely divided suspended matter after coagulation by gently stirring by either mechanical or hydraulic means. In biological wastewater treatment where coagulation is not used, agglomeration may be accomplished biologically.

### Flow Rate

Usually expressed as liters/minute (gallons/minute) or liters/day (million gallons/day). Design flow rate is that used to size the wastewater treatment process. Peak flow rate is 1.5 to 2.5 times design and relates to the hydraulic flow limit and is specified for each plant. Flow rates can be mixed as batch and continuous where these two treatment modes are used on the same plant.

### Flow-Nozzle Meter

A water meter of the differential medium type in which the flow through the primary element or nozzle produces a pressure difference or differential head, which the secondary element or float tube then uses as an indication of the rate of flow.

### Flue Gas

The gaseous products resulting from the combustion process after passage through the boiler.

### Fly Ash

A portion of the noncombustible residue from a fuel which is carried out of the boiler by the flue gas.

### Fossil Fuel

A natural solid, liquid, or gaseous fuel such as coal, petroleum, or natural gas.

### Frequency Distribution

An arrangement or distribution of quantities pertaining to a single element in order of their magnitude.

### Gauging Station

A location on a stream or conduit where measurements of discharge are customarily made. The location includes a stretch of channel through which the flow is uniform and a control downstream from this stretch. The station usually has a recording or other gauge for measuring the elevation of the water surface in the channel or conduit.

### Grab Sample

A single sample of wastewater taken at neither a set time nor flow.

### Generation

The conversion of chemical or mechanical energy into electrical energy.

### Hardness

A characteristic of water, imparted by salts of calcium, magnesium, and iron, such as bicarbonates, carbonates, sulfates, chlorides, and nitrates, that causes curdling of soap, deposition of scale in boilers, damage in some industrial process, and sometimes objectionable taste. It may be determined by a standard laboratory procedure or computed from the amounts of calcium and magnesium as well as iron, aluminum, manganese, barium, strontium, and zinc, and is expressed as equivalent calcium carbonate.

### Heat of Adsorption

The heat given off when molecules are adsorbed.

### High Rate

The fuel heat input (in Joules or Btu's) required to generate a kWh.

### Heating Value

The heat available from the combustion of a given quantity of fuel as determined by a standard calorimetric process.

### Humidity

Pounds of water vapor carried by 1 pound of dry air.

### Ion

A charged atom, molecule or radical, the migration of which affects the transport of electricity through an electrolyte.

### Ion Exchange

A chemical process involving reversible interchange of ions between a liquid and solid but no radical change in the structure of the solid.

### Incineration

The combustion (by burning) of organic matter in wastewater sludge solids after water evaporation from the solids.

### Lagoon

(1) A shallow body of water as a pond or lake which usually has a shallow, restricted inlet from the sea.

(2) A pond containing raw or partially treated wastewater in which aerobic or anerobic stabilization occurs.

### Lignite

A carbonaceous fuel ranked between peat and coal.

### Lime

Any of a family of chemicals consisting essentially of calcium hydroxide made from limestone (calcite) which is composed almost wholly of calcium carbonate or a mixture of calcium and magnesium carbonates.

### Makeup Water Pumps

Pumps which provide water to replace that lost by evaporation, seepage, and blowdown.

### Manometer

An instrument for measuring pressure. It usually consists of a U-shaped tube containing a liquid, the surface of which moves proportionally with changes in pressure on the liquid in the other end. Also, a tube type of differential pressure gauge.

### Mean Velocity

The average velocity of a stream flowing in a channel or conduit at a given cross section or in a given reach. It is equal to the discharge divided by the cross sectional area of the reach. Also called average velocity.

### Mechanical Draft Tower

A cooling tower in which the air flow through the tower is maintained by fans. In forced draft towers, the air is forced through the tower by fans located at its base; whereas in induced draft towers, the air is pulled through the tower by fans mounted on top of the tower.

### Mesh Size (Activated Carbon)

The particle size of granular activated carbon as determined by the U.S. Sieve series. Particle size distribution within a mesh series is given in the specification of the particular carbon.

### Milligrams Per Liter (mg/l)

This is a weight per volume designation used in water and wastewater analysis.

### Mine-Mouth Plant

A steam electric powerplant located within a short distance of a coal mine and to which the coal is transported from the mine by a conveyor system, slurry pipeline, or truck.

### Mixed-Media Filtration

A filter which uses two or more filter materials of differing specific gravities selected so as to produce a filter uniformly graded from coarse to fine.

### Mole

The molecular weight of a substance expressed in grams (or pounds).

### Monitoring

- (1) The procedure or operation of locating and measuring radioactive contamination by means of survey instruments that can detect and measure, as dose rate, ionizing radiations.
- (2) The measurements, sometimes continuous, of water quality.

### Name Plate

Name plate--design rating of a plant or specific piece of equipment.

### Natural Draft Cooling Tower

A cooling tower through which air is circulated by a natural or chimney effect. A hyperbolic tower is a natural draft tower that is hyperbolic in shape.

### Neutralization

Reaction of acid or alkaline solutions with the opposite reagent until the concentrations of hydrogen and hydroxyl ions are about equal.

### New Source

Any source, the construction of which is begun after the publication of proposed Section 306 regulations, (March 4, 1974 for the Steam Electric Power Generating Point Source Category).

### Nominal Capacity

See Name Plate.

### Nuclear Energy

The energy derived from the fission of nuclei of heavy elements such as uranium or thorium or from the fusion of the nuclei of light elements such as deuterium or tritium.

### Once-Through Circulating Water System

A circulating water system which draws water from a natural source, passes it through the main condensers, and returns it to a natural body of water.

### Osmosis

The process of diffusion of a solvent through a semipermeable membrane from a solution of lower to one of higher concentration.

### Osmotic Pressure

The equilibrium pressure differential across a semipermeable membrane which separates a solution of lower from one of higher concentration.

### Overflow

- (1) Excess water over the normal operating limits disposed of by letting it flow out through a device provided for that purpose.
- (2) The device itself that allows excess water to flow out.

### Outfall

The point or location where sewage or drainage discharges from a sewer, drain, or conduit.

### Oxidation

The addition of oxygen to a chemical compound, generally any reaction which involves the loss of electrons from an atom.

### Package Sewage Treatment Plant

A sewage treatment facility contained in a small area and generally prefabricated in a complete package.

### Packing (Cooling Towers)

A media providing large surface area for the purpose of enhancing mass and heat transfer, usually between a gas vapor and a liquid.

### Peak-Load Plant

A generating facility operated only during periods at maximum demand.

### pH Value

A scale for expressing the acidity or alkalinity of a solution. Mathematically, it is the logarithm of the reciprocal of the gram ionic hydrogen equivalents per liter. Neutral water has a pH of 7.0 and hydrogen ion concentration of  $10^{-7}$  moles per liter.



Placed in Service

Refers to the data when a generating unit initially generated electrical power to service customers.

Plant Code Number

A four-digit number assigned to all powerplants in the industry inventory for the purpose of this study.

Plume (Gas)

A conspicuous trail of gas or vapor emitted from a cooling tower or chimney.

Pond, Sewage Oxidation

A pond, either natural or artificial, into which partly treated sewage is discharged and in which natural purification processes take place under the influence of sunlight and air.

Powerplant

Equipment that produces electrical energy generally by conversion from heat energy produced by chemical or nuclear reaction.

Precipitation

A phenomenon that occurs when a substance held in solution in a liquid phase passes out of solution into a solid phase.

Preheater (Air)

A unit used to heat the air needed for combustion of absorbing heat from the products of combustion.

Psychrometric

Refers to air-water vapor mixtures and their properties. A psychrometric chart graphically displays the relationship between these properties.

Pulverized Coal

Coal that has been ground to a powder, usually of a size where 80 percent passes through a #200 U.S.S. sieve.

Pyrites

Combinations of iron and sulfur found in coal as  $FeS_2$ .

### Radwaste

Radioactive waste streams from nuclear powerplants.

### Range

Difference between entrance and exit temperature of water in a cooling tower.

### Rank of Coal

A classification of coal based upon the fixed carbon as a dry weight basis and the heat value.

### Rankine Cycle

The thermodynamic cycle which is the basis of the steam electric generating process.

### Recirculation System

Facilities which are specifically designed to divert the major portion of the cooling water discharge back for reuse.

### Reduction

A chemical reaction which involves the addition of electrons to an ion to decrease its positive valence.

### Regeneration

Displacement from ion exchange resins of the ions removed from the process solution.

### Reheater

A heat exchange device for adding superheat to steam which has been partially expanded in the turbine.

### Reinjection

To return a flow, or portion of flow, into a process.

### Relative Humidity

Ratio of the partial pressure of the water vapor to the vapor pressure of water at air temperature.

### Residual Chlorine

Chlorine remaining in water or wastewater at the end of specified contact period as combined or free chlorine.

### Reverse Osmosis

The process of diffusion of a solute through a semipermeable membrane from a solution of lower to one of higher concentration, affected by raising the pressure of the less concentrated solution to above the osmotic pressure.

### Salinity

(1) The relative concentration of salts, usually sodium chloride, in a given water. It is usually expressed in terms of the number of parts per million of chloride (Cl).

(2) A measure of the concentration of dissolved mineral substances in water.

### Sampler

A device used with or without flow measurement to obtain any adequate portion of water or waste for analytical purposes. May be designed for taking a single sample (grab), composite sample, continuous sample, or periodic sample.

### Sampling Stations

Locations where several flow samples are tapped for analysis.

### Sanitary Wastewater

Wastewater discharged from sanitary conveniences of dwellings and industrial facilities.

### Saturated Air

Air in which water vapor is in equilibrium with liquid water at air temperature.

### Saturated Steam

Steam at the temperature and pressure at which the liquid and vapor phase can exist in equilibrium.

### Scale

Generally insoluble deposits on equipment and heat transfer surfaces which are created when the solubility of a salt is exceeded. Common scaling agents are calcium carbonate and calcium sulfate.

### Scrubber

A device for removing particles or objectionable gases from a stream of gas.

## Secondary Treatment

The treatment of sanitary wastewater by biological means after primary treatment by sedimentation.

### Sedimentation

The process of subsidence and deposition of suspended matter carried by a liquid.

### Sequestering Agents

Chemical compounds which are added to water systems to prevent the formation of scale by holding the insoluble compounds in suspension.

### Service Water Pumps

Pumps providing water for auxiliary plant heat exchangers and other uses.

### Settleable Solids

(1) That matter in wastewater which will not stay in suspension during a preselected settling period, such as 1 hour but either settles to the bottom or floats to the top.

(2) In the Imhoff cone test, the volume of matter that settles to the bottom of the cone in 1 hour.

### Slag Tap Furnace

Furnace in which the temperature is high enough to maintain ash (slag) in a molten state until it leaves the furnace through a tap at the bottom. The slag falls into the sluicing water where it cools, disintegrates, and is carried away.

### Slimecide

An agent used to destroy or control slimes.

### Sludge

Accumulated solids separated from a liquid during processing.

### Softener

Any device used to remove hardness from water. Hardness in water is due mainly to calcium and magnesium salts. Natural zeolites, ion exchange resins, and precipitation processes are used to remove the calcium and magnesium.

### Spinning Reserve

The power generating reserve connected to the bus bar and ready to take load. Normally consists of units operating at less than full load. Gas turbines, even though not running, are considered spinning reserve due to their quick startup time.

### Spray Module (Powered Spray Module)

A water cooling device consisting of a pump and spray nozzle or nozzles mounted on floats and moored in the body of water to be cooled. Heat is transferred principally by evaporation from the water drops as they fall through the air.

### Stabilization Lagoon

A shallow pond for storage of wastewater before discharge. Such lagoons may serve only to detain and equalize wastewater composition before regulated discharge to a stream, but often they are used for biological oxidation.

### Stabilization Pond

A type of oxidation pond in which biological oxidation of organic matter is affected by natural or artificially accelerated transfer of oxygen to the water from air.

### Steam Drum

Vessel in which the saturated steam is separated from the steam-water mixture and into which the feedwater is introduced.

### Supercritical

Refers to boilers designed to operate at or above the critical point of water 22,100 kN/square meters and 374.0°C (3206.2 psia and 705.4°F).

### Superheated Steam

Steam which has been heated to a temperature above that corresponding to saturation at a specific pressure.

### Suspended Solids

(1) Solids which either float on the surface of or are in suspension in water, wastewater, or other liquids, and which are largely removable by laboratory filtering.

(2) The quantity of material removed from wastewater in a laboratory test, as prescribed in "Standard Methods for the Examination of Water and Wastewater" and referred to as nonfilterable residue.

### Thermal Efficiency

The efficiency of the thermodynamic cycle in producing work from heat. The ratio of usable energy to heat input expressed as a percent.

### Thickening

Process of increasing the solids content of sludge.

### Total Dynamic Head (TDH)

Total energy provided by a pump consisting of the difference in elevation between the suction and discharge levels, plus losses due to unrecovered velocity heads and friction.

### Total Solids

The total amount of solids in a wastewater in both solution and suspension.

### Turbine

A device used to convert the energy of steam or gas into rotational mechanical energy and used as prime mover to drive electric generators.

### Treatment Efficiency

Usually refers to the percentage reduction of a specific or group of pollutants by a specific wastewater treatment step or treatment plant.

### Turbidimeter

An instrument for measurement of turbidity in which a standard suspension usually is used for reference.

### Turbidity

- (1) A condition in water or wastewater caused by the presence of suspended matter, resulting in the scattering and adsorption of light rays.
- (2) A measure of fine suspended matter in liquids.
- (3) An analytical quantity usually reported in arbitrary turbidity units determined by measurements of light diffraction.

### Turbulent Flow

(1) The flow of a liquid past an object such that the velocity at any fixed point in the fluid varies irregularly.

(2) A type of liquid flow in which there is an unsteady motion of the particles and the motion at a fixed point varies in no definite manner. Sometimes called eddy flow, sinuous flow.

### Unit

In steam electric generation, the basic system for power generation consisting of a boiler and its associated turbine and generator with the required auxiliary equipment.

### Utility

(Public utility)--A company either investor-owned or publicly owned which provides service to the public in general. The electric utilities generate and distribute electric power.

### Volatile Combustion Matter

The relatively light components in a fuel which readily vaporize at a relatively low temperature and which when combined or reacted with oxygen, giving out light and heat.

### Wet Bottom Furnace

See slag-tap furnace.

### Wet Bulb Temperature

The steady-state, nonequilibrium temperature reached by a small mass of water immersed under adiabatic conditions in a continuous stream of air.

### Wet Scrubber

A device for the collection of particulate matter from a gas stream or adsorption of certain gases from the stream.





APPENDIX A

TVA RAW RIVER INTAKE AND  
ASH POND DISCHARGE DATA

Quarterly Samples

1973-1976



Table A-1

TVA PLANT A RIVER WATER INTAKE AND FLY ASH POND DISCHARGE DATA  
(Quarterly Samples)

Date	1/73		4/2/73		7/2/73		10/1/73	
	River	Pond	River	Pond	River	Pond	River	Pond
	Intake	Discharge	Intake	Discharge	Intake	Discharge	Intake	Discharge
Aluminum, mg/l	NA	6.4	NA	8.8	NA	3.7	NA	7.5
Ammonia as N, mg/l	NA	0.10	NA	0.49	NA	0.02	NA	0.04
Arsenic, mg/l	NA	0.023	NA	0.010	NA	0.015	NA	0.005
Barium, mg/l	NA	0.3	NA	0.2	NA	0.2	NA	0.2
Beryllium, mg/l	NA	<0.01	NA	<0.01	NA	<0.01	NA	<0.01
Cadmium, mg/l	NA	0.037	NA	0.036	NA	0.023	NA	0.052
Calcium, mg/l	NA	170	NA	170	NA	180	NA	160
Chloride, mg/l	NA	6	NA	6	NA	7	NA	14
Chromium, mg/l	NA	0.049	NA	0.033	NA	0.012	NA	0.016
Conductivity, 25°C, umhos/cm	NA	750	NA	780	NA	750	NA	840
Copper, mg/l	NA	0.36	NA	0.35	NA	0.25	NA	0.30
Cyanide, mg/l	NA	<0.01	NA	<0.01	NA	<0.01	NA	<0.01
Hardness, mg/l	NA	480	NA	490	NA	490	NA	460
Iron, mg/l	NA	1.1	NA	0.97	NA	0.47	NA	0.42
Lead, mg/l	NA	<0.010	NA	0.100	NA	<0.010	NA	0.034
Magnesium, mg/l	NA	13	NA	16	NA	9.5	NA	15
Manganese, mg/l	NA	0.50	NA	0.56	NA	0.45	NA	0.50
Mercury, mg/l	NA	0.0006	NA	0.0006	NA	<0.0002	NA	<0.0002
Nickel, mg/l	NA	0.13	NA	0.12	NA	0.11	NA	0.13
Phosphorous, mg/l	NA	0.18	NA	<0.03	NA	0.04	NA	0.03
Selenium, mg/l	NA	0.004	NA	<0.001	NA	<0.001	NA	<0.001
Silica, mg/l	NA	15	NA	14	NA	12	NA	14
Silver, mg/l	NA	<0.01	NA	<0.01	NA	<0.01	NA	<0.01
Solids, Dissolved, mg/l	NA	680	NA	700	NA	570	NA	700
Solids, Suspended, mg/l	NA	17	NA	6	NA	<1	NA	3
Sulfate, mg/l	NA	410	NA	380	NA	300	NA	440
Zinc, mg/l	NA	1.4	NA	1.3	NA	1.2	NA	1.7

NA = Not Available

Table A-1 (Continued)

TVA PLANT A RIVER WATER INTAKE AND FLY ASH POND DISCHARGE DATA  
(Quarterly Samples)

Date	1/15/74		4/8/74		7/15/74		10/8/74	
	River Intake	Pond Discharge	River Intake	Pond Discharge	River Intake	Pond Discharge	River Intake	Pond Discharge
Aluminum, mg/l	5.7	13	6.7	6.6	1.0	3.6	1.1	7.9
Ammonia as N, mg/l	0.14	1.4	0.04	1.0	0.04	0.26	0.02	0.15
Arsenic, mg/l	<0.005	0.005	<0.005	<0.005	<0.005	0.005	<0.005	0.010
Barium, mg/l	0.1	0.2	0.4	0.4	0.2	0.3	0.2	0.2
Beryllium, mg/l	<0.01	<0.01	<0.01	0.02	<0.01	<0.01	<0.01	<0.01
Cadmium, mg/l	<0.001	0.041	<0.001	0.030	<0.001	0.038	<0.001	0.037
Calcium, mg/l	24	110	27	94	41	94	41	110
Chloride, mg/l	4	5	4	5	9	8	9	6
Chromium, mg/l	0.021	0.17	0.024	0.056	<0.005	0.12	0.008	0.082
Conductivity, 25°C, umhos/cm	140	710	210	740	320	640	310	680
Copper, mg/l	0.19	0.45	0.14	0.30	0.08	0.16	0.04	0.30
Cyanide, mg/l	-	<0.01	-	<0.01	-	<0.01	-	-
Hardness, mg/l	69	340	91	320	140	280	90	310
Iron, mg/l	5.4	6.6	6.7	1.0	1.3	0.33	1.1	0.60
Lead, mg/l	0.02	0.20	<0.010	0.021	0.026	<0.024	0.038	0.064
Magnesium, mg/l	4.1	17	5.7	20	8.0	12	6.8	9.4
Manganese, mg/l	0.17	0.63	0.25	0.59	0.10	0.29	0.08	0.31
Mercury, mg/l	<0.0002	<0.0002	<0.0002	<0.0002	<0.0002	<0.0002	<0.0002	<0.0002
Nickel, mg/l	<0.05	0.10	0.05	0.08	<0.05	0.06	<0.05	0.11
Phosphorous, mg/l	0.12	0.02	0.13	0.02	0.04	0.02	0.03	0.02
Selenium, mg/l	<0.002	0.002	<0.002	<0.002	<0.002	<0.002	<0.002	<0.002
Silica, mg/l	5.2	11	6.9	12	1.7	-	6.3	10
Silver, mg/l	<0.01	<0.01	<0.01	<0.01	<0.01	0.01	<0.01	<0.01
Solids, Dissolved, mg/l	120	620	120	560	200	470	170	500
Solids, Suspended, mg/l	100	6	190	5	14	2	45	6
Sulfate, mg/l	6	280	28	430	24	240	15	380
Zinc, mg/l	0.09	2.7	0.12	1.1	0.08	1.3	0.06	1.4

Table A-1 (Continued)

TVA PLANT A RIVER WATER INTAKE AND FLY ASH POND DISCHARGE DATA  
(Quarterly Samples)

Date	2/3/75		4/7/75		7/14/75		10/14/75	
	River Intake	Pond Discharge	River Intake	Pond Discharge	River Intake	Pond Discharge	River Intake	Pond Discharge
Aluminum, mg/l	0.05	6.2	*	10	1.2	12	2.1	9.6
Ammonia as N, mg/l	0.10	1.2	0.02	0.75	0.04	0.54	0.14	3.1
Arsenic, mg/l	no sample	<0.005	<0.005	<0.005		0.010	0.005	0.035
Barium, mg/l	<0.1	<0.1	*	<0.1	<0.1	0.2	<0.1	<0.1
Beryllium, mg/l	<0.01	<0.01	*	<0.01	<0.01	0.01	<0.01	<0.01
Cadmium, mg/l	0.004	0.025	*	0.051	0.001	0.057	<0.001	0.025
Calcium, mg/l	29	88	*	110	48	120	35	110
Chloride, mg/l	6	5	4	4	5	9	10	9
Chromium, mg/l	<0.005	0.052	*	0.016	<0.005	0.230	<0.005	0.029
Conductivity, 25°C, umhos/cm	240	590	190	740	280	1000	260	880
Copper, mg/l	0.05	0.24	*	0.35	0.04	0.41	0.09	0.43
Cyanide, mg/l	<0.01	<0.01	-	-	-	-	-	-
Hardness, mg/l	91	270	*	370	150	350	120	340
Iron, mg/l	1.4	2.2	*	8.6	1.4	4.0	1.9	1.5
Lead, mg/l	0.021	0.052	*	0.083	<0.010	0.150	0.022	0.042
Magnesium, mg/l	4.5	13	*	12	6.6	13	7.1	17
Manganese, mg/l	0.12	0.44	*	0.50	0.10	0.57	0.12	0.51
Mercury, mg/l	<0.0002	<0.0002	<0.0002	<0.0002	<0.0002	<0.0002	<0.0002	<0.0002
Nickel, mg/l	<0.05	0.07	*	0.11	0.05	0.13	<0.05	<0.05
Phosphorous, mg/l	<0.01	<0.01	0.05	0.04	0.14	0.04	0.06	0.05
Selenium, mg/l	no sample	<0.002	<0.002	0.002	<0.002	<0.002	<0.001	<0.002
Silica, mg/l	8.0	9.3	5.6	12	6.0	20	5.4	15
Silver, mg/l	<0.01	<0.01	*	<0.01	<0.01	<0.01	<0.01	<0.01
Solids, Dissolved, mg/l	140	470	150	500	170	700	176	640
Solids, Suspended, mg/l	57	4	21	8	18	9	33	3
Sulfate, mg/l	30	290	28	340	18	390	21	270
Zinc, mg/l	0.14	0.82	*	1.2	0.06	1.8	0.10	1.0

\*Bottle Broken

Table A-1 (Continued)

TVA PLANT A RIVER WATER INTAKE AND FLY ASH POND DISCHARGE DATA  
(Quarterly Samples)

Date	1/8/76		4/13/76	
	River Intake	Pond Discharge	River Intake	Pond Discharge
Aluminum, mg/l	1.2	9.5	1.0	7.4
Ammonia as N, mg/l	0.07	0.89	0.03	0.55
Arsenic, mg/l	<0.005	0.005	<0.005	<0.005
Barium, mg/l	<0.1	<0.1	<0.1	0.5
Beryllium, mg/l	<0.01	<0.01	<0.01	<0.01
Cadmium, mg/l	<0.001	0.049	<0.001	0.025
Calcium, mg/l	42	92	32	110
Chloride, mg/l	5	6	6	5
Chromium, mg/l	<0.005	0.080	<0.005	0.011
Conductivity, 25°C, umhos/cm	240	660	220	760
Copper, mg/l	0.02	0.32	0.03	0.32
Cyanide, mg/l	-	-	-	-
Hardness, mg/l	130	280	100	320
Iron, mg/l	1.2	5.6	1.3	2.0
Lead, mg/l	<0.010	0.050	<0.010	0.020
Magnesium, mg/l	5.4	13	5.5	11
Manganese, mg/l	0.10	0.46	0.12	0.46
Mercury, mg/l	<0.0002	<0.0002	<0.0002	NES
Nickel, mg/l	<0.05	0.05	<0.05	<0.05
Phosphorous, mg/l	0.04	0.06	0.04	0.03
Selenium, mg/l	<0.002	-	<0.002	<0.002
Silica, mg/l	7.0	14	*	13
Silver, mg/l	<0.01	<0.01	<0.01	<0.01
Solids, Dissolved, mg/l	150	480	130	510
Solids, Suspended, mg/l	31	25	36	9
Sulfate, mg/l	16	320	16	190
Zinc, mg/l	0.02	0.74	0.06	0.85

\*Bottle Empty

Table A-2

TVA PLANT A RIVER WATER INTAKE AND BOTTOM ASH POND DISCHARGE DATA  
(Quarterly Samples)

Date	1/2/73		4/2/73		7/2/73		10/1/73	
	River Intake	Pond Discharge	River Intake	Pond Discharge	River Intake	Pond Discharge	River Intake	Pond Discharge
Aluminum, mg/l	NA	2.6	NA	0.9	NA	8.0	NA	0.7
Ammonia as N, mg/l	NA	0.06	NA	0.06	NA	0.06	NA	0.22
Arsenic, mg/l	NA	0.002	NA	0.005	NA	0.015	NA	<0.005
Barium, mg/l	NA	<0.1	NA	<0.1	NA	0.1	NA	0.1
Beryllium, mg/l	NA	<0.01	NA	<0.01	NA	<0.01	NA	<0.01
Cadmium, mg/l	NA	<0.001	NA	<0.001	NA	<0.001	NA	<0.001
Calcium, mg/l	NA	33	NA	33	NA	44	NA	67
Chloride, mg/l	NA	6	NA	8	NA	8	NA	15
Chromium, mg/l	NA	<0.005	NA	<0.005	NA	<0.005	NA	<0.005
Conductivity, 25°C, umhos/cm	NA	250	NA	250	NA	290	NA	400
Copper, mg/l	NA	0.04	NA	<0.01	NA	0.08	NA	0.03
Cyanide, mg/l	NA	<0.01	NA	<0.01	NA	<0.01	NA	<0.01
Hardness, mg/l	NA	110	NA	110	NA	140	NA	170
Iron, mg/l	NA	3.8	NA	2.0	NA	7.5	NA	2.1
Lead, mg/l	NA	<0.010	NA	0.010	NA	<0.010	NA	<0.010
Magnesium, mg/l	NA	5.7	NA	6.7	NA	6.7	NA	0.3
Manganese, mg/l	NA	0.12	NA	0.14	NA	0.25	NA	0.15
Mercury, mg/l	NA	0.0008	NA	0.0004	NA	<0.0026	NA	<0.0002
Nickel, mg/l	NA	<0.05	NA	<0.05	NA	<0.05	NA	0.12
Phosphorous, mg/l	NA	0.17	NA	<0.03	NA	0.36	NA	0.09
Selenium, mg/l	NA	0.002	NA	<0.004	NA	<0.001	NA	<0.001
Silica, mg/l	NA	7.3	NA	8.1	NA	6.1	NA	8.6
Silver, mg/l	NA	<0.01	NA	<0.01	NA	<0.01	NA	<0.01
Solids, Dissolved, mg/l	NA	170	NA	180	NA	180	NA	260
Solids, Suspended, mg/l	NA	27	NA	13	NA	74	NA	6
Sulfate, mg/l	NA	41	NA	45	NA	50	NA	80
Zinc, mg/l	NA	0.08	NA	0.03	NA	0.07	NA	0.02

NA = Not Available

Table A-2 (Continued)

TVA PLANT A RIVER WATER INTAKE AND BOTTOM ASH POND DISCHARGE DATA  
(Quarterly Samples)

Date	1/15/74		4/8/74		7/15/74		10/8/74	
	River	Pond	River	Pond	River	Pond	River	Pond
	<u>Intake</u>	<u>Discharge</u>	<u>Intake</u>	<u>Discharge</u>	<u>Intake</u>	<u>Discharge</u>	<u>Intake</u>	<u>Discharge</u>
Aluminum, mg/l	5.7	6.0	6.7	7.9	1.0	0.5	1.1	1.3
Ammonia as N, mg/l	0.14	0.05	0.04	0.34	0.04	0.12	0.02	0.04
Arsenic, mg/l	<0.005	0.005	<0.005	0.005	<0.005	<0.005	<0.005	<0.005
Barium, mg/l	0.1	0.1	0.4	0.3	0.2	0.2	0.2	0.2
Beryllium, mg/l	<0.01	<0.01	<0.01	<0.01	<0.01	<0.01	<0.01	<0.01
Cadmium, mg/l	<0.001	<0.001	<0.001	<0.001	<0.001	0.002	<0.001	<0.001
Calcium, mg/l	21	23	27	30	41	44	41	47
Chloride, mg/l	4	5	4	6	9	10	9	9
Chromium, mg/l	0.021	0.023	0.024	0.011	<0.005	<0.005	0.008	0.010
Conductivity, 25°C, umhos/cm	140	180	210	250	320	360	310	320
Copper, mg/l	0.19	0.12	0.14	0.14	0.08	0.01	0.04	0.09
Cyanide, mg/l	-	<0.01	-	<0.01	-	<0.01	-	-
Hardness, mg/l	69	76	91	100	140	150	90	150
Iron, mg/l	5.4	11	6.7	10	1.3	1.7	1.1	4.2
Lead, mg/l	0.02	0.031	<0.010	0.019	0.026	0.020	0.038	0.020
Magnesium, mg/l	4.1	4.4	5.7	6.0	8.0	9.3	6.8	7.7
Manganese, mg/l	0.17	0.16	0.25	0.26	0.10	0.07	0.08	0.12
Mercury, mg/l	<0.0002	<0.0002	<0.0002	0.0006	<0.0002	<0.0002	<0.0002	<0.0002
Nickel, mg/l	<0.05	<0.05	<0.05	<0.05	<0.05	0.05	<0.05	<0.05
Phosphorous, mg/l	0.12	0.14	0.13	0.23	0.04	0.03	0.03	0.03
Selenium, mg/l	<0.002	0.004	<0.002	<0.002	<0.002	<0.002	<0.002	<0.002
Silica, mg/l	5.2	6.3	6.9	7.4	1.7	-	6.3	8.0
Silver, mg/l	<0.01	<0.01	<0.01	<0.01	<0.01	<0.01	<0.01	<0.01
Solids, Dissolved, mg/l	120	150	120	170	200	240	170	200
Solids, Suspended, mg/l	100	120	190	200	14	5	45	26
Sulfate, mg/l	6	41	28	48	24	42	15	43
Zinc, mg/l	0.09	0.14	0.12	0.16	0.08	0.07	0.06	0.15



Table A-2 (Continued)

TVA PLANT A RIVER WATER INTAKE AND BOTTOM ASH POND DISCHARGE DATA  
(Quarterly Samples)

Date	1/14/75		4/7/75		7/14/75		10/14/75	
	River Intake	Pond Discharge	River Intake	Pond Discharge	River Intake	Pond Discharge	River Intake	Pond Discharge
Aluminum, mg/l	NA	4.9	*	3.1	1.2	0.7	2.1	2.1
Ammonia as N, mg/l	NA	0.06	0.02	0.06	0.04	0.09	0.14	0.14
Arsenic, mg/l	NA	<0.005	<0.005	<0.005		<0.005	0.005	0.015
Barium, mg/l	NA	0.1	*	<0.1	<0.1	<0.1	<0.1	<0.1
Beryllium, mg/l	NA	<0.01	*	<0.01	<0.01	<0.01	<0.01	<0.01
Cadmium, mg/l	NA	<0.001	*	0.002	0.001	0.001	<0.001	0.002
Calcium, mg/l	NA	34	*	23	48	51	35	26
Chloride, mg/l	NA	5	4	4	5	6	10	7
Chromium, mg/l	NA	<0.005	*	0.005	<0.005	<0.005	<0.005	<0.005
Conductivity, 25°C, umhos/cm	NA	260	190	200	280	320	260	160
Copper, mg/l	NA	0.02	*	0.09	0.04	0.11	0.09	0.09
Cyanide, mg/l	NA	<0.01	-	-	-	-	-	-
Hardness, mg/l	NA	110	*	76	150	160	120	94
Iron, mg/l	NA	8.3	*	5.6	1.4	2.3	1.9	4.1
Lead, mg/l	NA	0.018	*	0.028	<0.010	<0.010	0.022	0.018
Magnesium, mg/l	NA	5.8	*	4.6	6.6	7.1	7.1	7.1
Manganese, mg/l	NA	0.24	*	0.13	0.10	0.12	0.12	0.25
Mercury, mg/l	NA	<0.0002	<0.0002	<0.0002	<0.0002	<0.0002	<0.0002	<0.0002
Nickel, mg/l	NA	<0.05	*	<0.05	0.05	<0.05	<0.05	<0.05
Phosphorous, mg/l	NA	0.08	0.05	0.02	0.14	0.02	0.06	0.05
Selenium, mg/l	NA	<0.002	<0.002	<0.002	<0.002	<0.002	<0.001	<0.001
Silica, mg/l	NA	9.3	5.6	6.0	6.0	7.6	5.4	6.5
Silver, mg/l	NA	<0.01	*	<0.01	<0.01	<0.01	<0.01	<0.01
Solids, Dissolved, mg/l	NA	170	150	140	170	200	160	160
Solids, Suspended, mg/l	NA	110	21	21	18	6	33	14
Sulfate, mg/l	NA	29	28	40	18	63	21	23
Zinc, mg/l	NA	0.06	*	0.10	0.06	0.09	0.10	0.02

NA = Not Available

\*Bottle Broken

Table A-2 (Continued)

TVA PLANT A RIVER WATER INTAKE AND BOTTOM ASH POND DISCHARGE DATA  
(Quarterly Samples)

Date	1/8/76		4/13/76	
	River Intake	Pond Discharge	River Intake	Pond Discharge
Aluminum, mg/l	NA	3.3	NA	2.0
Ammonia as N, mg/l	NA	0.06	NA	0.07
Arsenic, mg/l	NA	0.005	NA	<0.005
Barium, mg/l	NA	<0.1	NA	<0.1
Beryllium, mg/l	NA	<0.01	NA	<0.01
Cadmium, mg/l	NA	<0.001	NA	<0.001
Calcium, mg/l	NA	43	NA	38
Chloride, mg/l	NA	6	NA	6
Chromium, mg/l	NA	0.008	NA	<0.005
Conductivity, 25°C, umhos/cm	NA	280	NA	260
Copper, mg/l	NA	0.08	NA	0.09
Cyanide, mg/l	NA	-	NA	-
Hardness, mg/l	NA	130	NA	120
Iron, mg/l	NA	4.7	NA	4.4
Lead, mg/l	NA	<0.010	NA	<0.010
Magnesium, mg/l	NA	6.0	NA	6.3
Manganese, mg/l	NA	0.14	NA	0.15
Mercury, mg/l	NA	<0.0002	NA	<0.0002
Nickel, mg/l	NA	<0.05	NA	<0.05
Phosphorous, mg/l	NA	0.07	NA	0.06
Selenium, mg/l	NA	<0.002	NA	<0.002
Silica, mg/l	NA	7.6	NA	6.3
Silver, mg/l	NA	<0.01	NA	<0.01
Solids, Dissolved, mg/l	NA	190	NA	160
Solids, Suspended, mg/l	NA	42	NA	33
Sulfate, mg/l	NA	45	NA	41
Zinc, mg/l	NA	0.12	NA	0.09

NA = Not Available

\*Bottle Empty

Table A-3

TVA PLANT B RIVER WATER INTAKE AND FLY ASH POND DISCHARGE DATA  
(Quarterly Samples)

Date	1/21/73		4/5/73		7/23/73		10/1/73	
	River Intake	Pond Discharge	River Intake	Pond Discharge	River Intake	Pond Discharge	River Intake	Pond Discharge
Aluminum, mg/l	NA	1.8	NA	0.7	NA	4.8	NA	2.6
Ammonia as N, mg/l	NA	0.11	NA	0.20	NA	0.08	NA	0.04
Arsenic, mg/l	NA	0.065	NA	0.050	NA	0.010	NA	0.005
Barium, mg/l	NA	0.1	NA	<0.1	NA	0.1	NA	<0.1
Beryllium, mg/l	NA	<0.01	NA	<0.01	NA	<0.01	NA	<0.01
Cadmium, mg/l	NA	<0.001	NA	0.002	NA	<0.001	NA	<0.001
Calcium, mg/l	NA	250	NA	130	NA	430	NA	33
Chloride, mg/l	NA	7	NA	4	NA	6	NA	8
Chromium, mg/l	NA	0.036	NA	<0.005	NA	0.011	NA	<0.005
Conductivity, 25°C, umhos/cm	NA	940	NA	580	NA	2,200	NA	240
Copper, mg/l	NA	<0.01	NA	0.02	NA	0.02	NA	<0.01
Cyanide, mg/l	NA	<0.01	NA	<0.01	NA	<0.01	NA	<0.01
Hardness, mg/l	NA	650	NA	340	NA	1,100	NA	110
Iron, mg/l	NA	0.69	NA	7.1	NA	1.2	NA	4.2
Lead, mg/l	NA	<0.010	NA	<0.010	NA	<0.010	NA	<0.010
Magnesium, mg/l	NA	6.8	NA	4.4	NA	0.2	NA	5.9
Manganese, mg/l	NA	0.04	NA	0.63	NA	0.04	NA	0.12
Mercury, mg/l	NA	0.0056	NA	0.0002	NA	0.0010	NA	<0.0002
Nickel, mg/l	NA	<0.05	NA	<0.05	NA	<0.05	NA	<0.05
Phosphorous, mg/l	NA	0.55	NA	0.24	NA	0.03	NA	0.18
Selenium, mg/l	NA	0.064	NA	0.007	NA	0.030	NA	<0.001
Silica, mg/l	NA	8.0	NA	22	NA	3.7	NA	6.0
Silver, mg/l	NA	<0.01	NA	<0.01	NA	<0.01	NA	<0.01
Solids, Dissolved, mg/l	NA	760	NA	440	NA	1,100	NA	160
Solids, Suspended, mg/l	NA	13	NA	14	NA	28	NA	39
Sulfate, mg/l	NA	450	NA	230	NA	480	NA	44
Zinc, mg/l	NA	0.08	NA	0.04	NA	0.09	NA	0.03

NA = Not Available

Table A-3 (Continued)

TVA PLANT B RIVER WATER INTAKE AND FLY ASH POND DISCHARGE DATA  
(Quarterly Samples)

Date	2/12/74		5/15/74	4/8/74	8/13/74	7/16/74	11/12/74	10/30/74
	River Intake	Pond Discharge	River Intake	Pond Discharge	River Intake	Pond Discharge	River Intake	Pond Discharge
Aluminum, mg/l	1.6	0.8	1.0	1.8	0.6	1.0	0.2	0.9
Ammonia as N, mg/l	0.04	0.09	0.05	<0.01	0.06	<0.01	0.04	0.02
Arsenic, mg/l	<0.005	0.010	<0.005	0.065	<0.005	0.055	<0.005	<0.005
Barium, mg/l	<0.1	<0.1	<0.1	0.2	<0.1	<0.1	<0.1	0.1
Beryllium, mg/l	<0.01	<0.01	<0.01	<0.01	<0.01	<0.01	<0.01	<0.01
Cadmium, mg/l	<0.001	<0.001	<0.001	<0.001	<0.001	0.002	0.002	0.001
Calcium, mg/l	19	120	22	27	22	50	19	95
Chloride, mg/l	4	6	4	4	6	6	7	8
Chromium, mg/l	<0.005	0.017	<0.005	0.010	<0.005	<0.005	<0.005	0.034
Conductivity, 25°C, umhos/cm	150	550	150	200	170	67	-	620
Copper, mg/l	<0.01	<0.01	0.04	<0.05	<0.01	<0.01	<0.01	0.04
Cyanide, mg/l	-	<0.01	-	<0.01	-	<0.01	-	-
Hardness, mg/l	67	320	76	79	77	140	69	250
Iron, mg/l	0.9	1.1	0.47	0.66	0.44	0.26	0.36	0.19
Lead, mg/l	0.010	<0.010	<0.010	0.027	<0.010	0.024	<0.010	<0.010
Magnesium, mg/l	4.7	4.4	5.0	2.8	5.0	4.1	5.2	2.3
Manganese, mg/l	0.06	0.05	0.04	0.06	0.1	0.02	0.05	0.05
Mercury, mg/l	<0.0002	<0.0002	0.0009	<0.0002	<0.0002	<0.0002	<0.0002	<0.0002
Nickel, mg/l	<0.05	0.08	<0.05	<0.005	<0.05	<0.05	<0.05	<0.05
Phosphorous, mg/l	-	0.10	0.03	0.13	0.04	0.10	0.02	<0.01
Selenium, mg/l	<0.001	0.004	<0.002	0.007	<0.002	<0.002	<0.002	<0.002
Silica, mg/l	7.2	7.8	5.1	3.8	4.8	-	4.6	4.5
Silver, mg/l	<0.01	<0.01	<0.01	<0.01	<0.01	<0.01	<0.01	<0.01
Solids, Dissolved, mg/l	90	40	90	130	100	250	-	460
Solids, Suspended, mg/l	14	15	4	15	7	3	-	2
Sulfate, mg/l	12	190	11	35	14	110	14	230
Zinc, mg/l	0.02	0.02	<0.01	<0.01	0.01	0.13	<0.01	0.06

A-10

Table A-3 (Continued)

TVA PLANT B RIVER WATER INTAKE AND FLY ASH POND DISCHARGE DATA  
(Quarterly Samples)

Date	2/4/75	1/15/75	5/19/75	4/21/75	8/5/75	4/14/75	11/4/75	10/14/75
	River Intake	Pond Discharge	River Intake	Pond Discharge	River Intake	Pond Discharge	River Intake	Pond Discharge
Aluminum, mg/l	-	0.6	0.4	1.3	0.5	1.6	0.7	1.5
Ammonia as N, mg/l	0.08	0.09	0.08	0.11	0.05	0.02	0.04	0.06
Arsenic, mg/l	<0.005	<0.005	<0.005	0.005	<0.005	0.070	0.005	0.008
Barium, mg/l	-	0.2	<0.1	<0.1	<0.1	0.2	<0.1	<0.1
Beryllium, mg/l	-	<0.01	<0.01	<0.01	<0.01	<0.01	<0.01	<0.01
Cadmium, mg/l	<0.001	<0.001	0.003	<0.001	0.01	0.001	0.002	<0.001
Calcium, mg/l	17	110	20	220	-	190	16	170
Chloride, mg/l	6	7	4	7	7	6	7	7
Chromium, mg/l	<0.005	<0.005	<0.005	0.020	<0.005	0.006	<0.005	<0.005
Conductivity, 25°C, umhos/cm	160	650	150	880	-	790	140	730
Copper, mg/l	0.02	<0.01	<0.01	0.03	0.02	0.08	<0.01	0.10
Cyanide, mg/l	-	<0.01	-	-	-	-	-	-
Hardness, mg/l	57	290	67	550	-	480	56	450
Iron, mg/l	0.32	0.48	0.68	0.21	0.38	0.27	0.37	0.14
Lead, mg/l	-	0.014	<0.010	0.030	<0.010	<0.010	<0.010	<0.010
Magnesium, mg/l	3.6	3.6	4.5	0.6	-	2.1	3.8	6.1
Manganese, mg/l	0.06	0.31	0.04	0.03	0.08	0.02	0.06	0.03
Mercury, mg/l	<0.0002	<0.0002	<0.0002	0.0004	<0.0002	0.0120	<0.0002	0.0002
Nickel, mg/l	-	<0.05	<0.05	0.06	<0.05	<0.05	<0.05	<0.05
Phosphorous, mg/l	0.02	0.01	0.02	<0.01	0.02	0.04	0.01	0.04
Selenium, mg/l	<0.002	<0.002	<0.002	0.022	<0.002	0.018	<0.002	0.025
Silica, mg/l	5.6	5.9	3.2	7.2	5.6	6.5	4.8	3.1
Silver, mg/l	-	<0.01	<0.01	<0.01	<0.05	<0.01	<0.01	<0.01
Solids, Dissolved, mg/l	100	440	90	520	90	600	95	600
Solids, Suspended, mg/l	12	6	8	6	9	10	5	2
Sulfate, mg/l	18	160	9	300	10	17	10	320
Zinc, mg/l	0.04	0.04	<0.01	0.02	0.02	0.06	<0.01	0.03

A-11

Table A-4

TVA PLANT B RIVER WATER INTAKE AND BOTTOM ASH POND DISCHARGE DATA  
(Quarterly Samples)

Date	1/21/73		4/5/73		7/23/73		10/1/73	
	River Intake	Pond Discharge	River Intake	Pond Discharge	River Intake	Pond Discharge	River Intake	Pond Discharge
Aluminum, mg/l	NA	1.5	NA	2.2	NA	0.9	NA	4.1
Ammonia as N, mg/l	NA	0.09	NA	0.04	NA	0.01	NA	0.06
Arsenic, mg/l	NA	<0.005	NA	0.005	NA	0.010	NA	0.050
Barium, mg/l	NA	<0.1	NA	<0.1	NA	<0.1	NA	<0.1
Beryllium, mg/l	NA	<0.01	NA	<0.01	NA	<0.01	NA	<0.01
Cadmium, mg/l	NA	<0.001	NA	<0.001	NA	<0.001	NA	0.01
Calcium, mg/l	NA	24	NA	23	NA	30	NA	200
Chloride, mg/l	NA	7	NA	5	NA	6	NA	8
Chromium, mg/l	NA	<0.005	NA	<0.005	NA	<0.005	NA	0.026
Conductivity, 25°C, umhos/cm	NA	210	NA	180	NA	210	NA	750
Copper, mg/l	NA	<0.01	NA	0.03	NA	0.01	NA	<0.01
Cyanide, mg/l	NA	<0.01	NA	<0.01	NA	<0.01	NA	<0.01
Hardness, mg/l	NA	80	NA	78	NA	93	NA	520
Iron, mg/l	NA	3.2	NA	2.4	NA	1.8	NA	1.1
Lead, mg/l	NA	<0.010	NA	<0.010	NA	<0.010	NA	0.012
Magnesium, mg/l	NA	4.9	NA	5.1	NA	4.4	NA	4.8
Manganese, mg/l	NA	0.16	NA	0.12	NA	0.05	NA	0.07
Mercury, mg/l	NA	0.0026	NA	<0.0002	NA	0.0021	NA	<0.0002
Nickel, mg/l	NA	<0.05	NA	<0.05	NA	<0.05	NA	<0.05
Phosphorous, mg/l	NA	0.11	NA	0.18	NA	0.10	NA	0.36
Selenium, mg/l	NA	<0.001	NA	0.001	NA	-	NA	0.056
Silica, mg/l	NA	5.7	NA	5.6	NA	5.3	NA	3.7
Silver, mg/l	NA	<0.01	NA	<0.01	NA	<0.01	NA	<0.01
Solids, Dissolved, mg/l	NA	110	NA	120	NA	130	NA	630
Solids, Suspended, mg/l	NA	20	NA	15	NA	10	NA	46
Sulfate, mg/l	NA	30	NA	25	NA	36	NA	350
Zinc, mg/l	NA	0.03	NA	0.02	NA	0.02	NA	0.09

NA = Not Available

Table A-4 (Continued)

TVA PLANT B RIVER WATER INTAKE AND BOTTOM ASH POND DISCHARGE DATA  
(Quarterly Samples)

Date	2/12/74		5/15/74	4/8/74	8/13/74		11/12/74	10/30/74
	River Intake	Pond Discharge	River Intake	Pond Discharge	River Intake	Pond Discharge	River Intake	Pond Discharge
Aluminum, mg/l	1.6	3.7	1.0	8.6	0.6	NA	0.2	0.4
Ammonia as N, mg/l	0.04	0.08	0.05	0.31	0.06	NA	0.04	0.12
Arsenic, mg/l	<0.005	0.010	<0.005	<0.005	<0.005	NA	<0.005	<0.005
Barium, mg/l	<0.1	<0.1	<0.1	0.3	<0.1	NA	<0.1	<0.1
Beryllium, mg/l	<0.01	<0.01	<0.01	<0.01	<0.01	NA	<0.01	<0.01
Cadmium, mg/l	<0.001	<0.001	<0.001	0.004	<0.001	NA	0.002	0.001
Calcium, mg/l	19	37	22	120	22	NA	19	16
Chloride, mg/l	4	8	4	11	6	NA	7	8
Chromium, mg/l	<0.005	<0.005	<0.005	<0.005	<0.005	NA	<0.005	0.020
Conductivity, 25°C, umhos/cm	150	300	150	960	170	NA	-	220
Copper, mg/l	<0.01	0.04	0.04	0.18	<0.01	NA	<0.01	0.04
Cyanide, mg/l	-	<0.01	-	<0.01	-	NA	-	-
Hardness, mg/l	67	120	76	390	77	NA	69	57
Iron, mg/l	0.9	8.0	0.47	30	0.44	NA	0.36	1.1
Lead, mg/l	0.010	<0.010	<0.010	0.048	<0.010	NA	<0.010	<0.010
Magnesium, mg/l	4.7	7.0	5.0	21	5.0	NA	5.2	4.2
Manganese, mg/l	0.06	0.54	0.04	3.6	0.1	NA	0.05	0.04
Mercury, mg/l	<0.0002	<0.0002	0.0009	<0.0002	<0.0002	NA	<0.0002	<0.0002
Nickel, mg/l	<0.05	<0.05	<0.05	0.14	<0.05	NA	<0.05	<0.05
Phosphorous, mg/l	-	0.12	0.03	0.08	0.04	NA	0.02	0.04
Selenium, mg/l	0.001	0.014	<0.002	<0.002	<0.002	NA	<0.002	<0.002
Silica, mg/l	7.2	6.7	5.1	22	4.8	NA	4.6	4.8
Silver, mg/l	<0.01	<0.01	<0.01	<0.01	<0.01	NA	<0.01	<0.01
Solids, Dissolved, mg/l	90	190	90	710	100	NA	-	120
Solids, Suspended, mg/l	14	48	4	78	7	NA	-	4
Sulfate, mg/l	12	71	11	470	14	NA	14	22
Zinc, mg/l	0.02	0.24	<0.01	0.55	0.01	NA	<0.01	0.06

NA = Not Available

Table A-4 (Continued)

TVA PLANT B RIVER WATER INTAKE AND BOTTOM ASH POND DISCHARGE DATA  
(Quarterly Samples)

Date	2/4/75	1/15/75	5/19/75	4/21/75	8/5/75	7/14/75	11/4/75	10/14/75
	River Intake	Pond Discharge	River Intake	Pond Discharge	River Intake	Pond Discharge	River Intake	Pond Discharge
Aluminum, mg/l	-	1.2	0.4	1.4	0.5	0.6	0.7	0.5
Ammonia as N, mg/l	0.08	0.04	0.08	0.06	0.05	0.05	0.04	<0.01
Arsenic, mg/l	<0.0005	<0.0005	<0.005	<0.005	<0.005	<0.005	0.005	0.008
Barium, mg/l	-	<0.1	<0.1	<0.1	<0.1	0.1	<0.1	<0.1
Beryllium, mg/l	-	<0.01	<0.01	<0.01	<0.01	<0.01	<0.01	<0.01
Cadmium, mg/l	<0.001	<0.001	0.003	<0.001	0.01	0.001	0.002	<0.001
Calcium, mg/l	17	30	20	17	-	26	16	23
Chloride, mg/l	6	8	4	5	7	6	7	7
Chromium, mg/l	<0.005	0.008	<0.005	0.012	<0.005	<0.005	<0.005	<0.005
Conductivity, 25°C, umhos/cm	160	250	150	190	-	160	140	190
Copper, mg/l	0.02	0.20	<0.01	0.03	0.02	0.08	<0.01	0.06
Cyanide, mg/l	-	<0.01	-	-	-	-	-	-
Hardness, mg/l	57	93	67	60	-	85	56	79
Iron, mg/l	0.32	2.1	0.68	2.5	0.38	2.2	0.37	1.7
Lead, mg/l	-	0.042	<0.010	0.024	<0.010	<0.010	<0.010	<0.010
Magnesium, mg/l	3.6	4.5	4.5	4.3	-	4.9	3.8	5.2
Manganese, mg/l	0.06	0.13	0.04	0.09	0.08	0.08	0.06	0.09
Mercury, mg/l	<0.0002	<0.0002	<0.0002	0.042	<0.0002	<0.0002	<0.0002	0.0002
Nickel, mg/l	-	<0.05	<0.05	<0.05	<0.05	<0.05	<0.05	<0.05
Phosphorous, mg/l	0.02	0.03	0.02	0.03	0.02	0.04	0.01	0.03
Selenium, mg/l	<0.002	<0.002	<0.002	<0.002	<0.002	<0.002	<0.002	<0.002
Silica, mg/l	5.6	6.9	3.2	6.1	5.6	4.5	4.8	5.0
Silver, mg/l	-	<0.01	<0.01	<0.01	<0.05	<0.01	<0.01	<0.01
Solids, Dissolved, mg/l	100	140	90	120	90	120	95	110
Solids, Suspended, mg/l	12	23	8	13	9	16	5	2
Sulfate, mg/l	18	35	9	26	10	20	10	25
Zinc, mg/l	0.04	0.12	<0.01	0.11	0.02	0.12	<0.01	0.03

A-14



Table A-5

TVA PLANT C RIVER WATER INTAKE AND COMBINED ASH POND (EAST) DISCHARGE DATA  
(Quarterly Samples)

Date	1/73		4/3/73		7/3/73		9/30/73	
	River Intake	Pond Discharge	River Intake	Pond Discharge	River Intake	Pond Discharge	River Intake	Pond Discharge
Aluminum, mg/l	NA	1.8	NA	3.8	NA	2.7	NA	0.3
Ammonia as N, mg/l	NA	0.23	NA	0.12	NA	0.09	NA	0.04
Arsenic, mg/l	NA	0.008	NA	0.010	NA	0.015	NA	0.050
Barium, mg/l	NA	<0.1	NA	0.2	NA	0.1	NA	<0.1
Beryllium, mg/l	NA	<0.01	NA	<0.01	NA	<0.01	NA	<0.01
Cadmium, mg/l	NA	0.002	NA	0.004	NA	0.002	NA	0.003
Calcium, mg/l	NA	45	NA	86	NA	94	NA	100
Chloride, mg/l	NA	8	NA	11	NA	12	NA	16
Chromium, mg/l	NA	<0.005	NA	0.008	NA	<0.005	NA	<0.005
Conductivity, 25°C, umhos/cm	NA	380	NA	470	NA	430	NA	620
Copper, mg/l	NA	0.01	NA	<0.01	NA	0.02	NA	<0.01
Cyanide, mg/l	NA	<0.01	NA	<0.01	NA	<0.01	NA	<0.01
Hardness, mg/l	NA	140	NA	250	NA	290	NA	320
Iron, mg/l	NA	2.0	NA	4.1	NA	2.5	NA	0.34
Lead, mg/l	NA	<0.010	NA	0.069	NA	<0.010	NA	0.012
Magnesium, mg/l	NA	7.1	NA	9.4	NA	14	NA	16
Manganese, mg/l	NA	0.13	NA	0.27	NA	0.16	NA	0.25
Mercury, mg/l	NA	0.0025	NA	0.0006	NA	<0.0002	NA	<0.0002
Nickel, mg/l	NA	<0.05	NA	<0.05	NA	<0.05	NA	<0.05
Phosphorous, mg/l	NA	0.21	NA	0.24	NA	0.15	NA	0.21
Selenium, mg/l	NA	0.080	NA	-	NA	0.004	NA	<0.001
Silica, mg/l	NA	6.4	NA	7.5	NA	4.7	NA	8.0
Silver, mg/l	NA	<0.01	NA	<0.01	NA	<0.01	NA	<0.01
Solids, Dissolved, mg/l	NA	260	NA	310	NA	300	NA	460
Solids, Suspended, mg/l	NA	17	NA	37	NA	25	NA	4
Sulfate, mg/l	NA	120	NA	130	NA	110	NA	170
Zinc, mg/l	NA	0.09	NA	0.08	NA	0.10	NA	0.02

NA = Not Available

Table A-5 (Continued)

TVA PLANT C RIVER WATER INTAKE AND COMBINED ASH POND (EAST) DISCHARGE DATA  
(Quarterly Samples)

Date	1/15/74		4/9/74		7/16/74		10/18/74	
	River Intake	Pond Discharge	River Intake	Pond Discharge	River Intake	Pond Discharge	River Intake	Pond Discharge
Aluminum, mg/l	1.4	2.4	3.7	1.1	4.9	1.9	1.9	0.3
Ammonia as N, mg/l	0.28	0.23	0.03	0.02	0.12	0.08	0.29	0.07
Arsenic, mg/l	0.010	0.005	<0.005	0.010	<0.005	0.005	<0.005	<0.005
Barium, mg/l	0.1	0.2	0.2	0.4	0.2	0.3	0.2	0.1
Beryllium, mg/l	<0.01	<0.01	<0.01	<0.01	<0.01	<0.01	<0.01	<0.01
Cadmium, mg/l	<0.001	0.010	<0.001	0.010	<0.001	0.006	<0.001	0.004
Calcium, mg/l	15	80	29	70	28	83	38	100
Chloride, mg/l	9	9	12	12	10	10	16	15
Chromium, mg/l	0.041	0.008	<0.005	<0.005	<0.005	<0.005	0.016	<0.010
Conductivity, 25°C, umhos/cm	170	510	310	560	300	580	410	600
Copper, mg/l	0.22	<0.01	0.12	0.10	0.15	0.07	0.06	0.04
Cyanide, mg/l	-	<0.01	-	<0.01	-	<0.01	-	-
Hardness, mg/l	65	230	110	180	110	250	150	310
Iron, mg/l	14	3.3	3.7	1.6	6.1	2.7	2.4	0.33
Lead, mg/l	0.032	0.024	0.02	<0.010	0.022	0.020	0.010	0.020
Magnesium, mg/l	6.8	7.2	9.4	1.4	9.8	11	14	14
Manganese, mg/l	0.34	0.25	0.12	0.34	0.38	0.18	0.53	0.19
Mercury, mg/l	<0.0002	0.11	<0.0002	0.0074	0.0016	<0.0002	<0.0002	<0.0002
Nickel, mg/l	0.05	0.07	<0.05	<0.05	<0.05	<0.05	<0.05	<0.05
Phosphorous, mg/l	0.49	0.02	0.28	0.02	0.29	-	0.06	<0.01
Selenium, mg/l	0.004	0.010	<0.002	<0.002	<0.002	<0.002	<0.002	<0.002
Silica, mg/l	7.1	7.2	7.9	8.7	-	-	5.4	6.5
Silver, mg/l	<0.01	<0.01	<0.01	<0.01	<0.01	<0.01	<0.01	0.03
Solids, Dissolved, mg/l	170	330	160	350	200	-	240	400
Solids, Suspended, mg/l	38	32	32	22	31	24	39	3
Sulfate, mg/l	48	190	44	190	40	160	52	170
Zinc, mg/l	0.13	0.25	0.08	0.22	0.03	0.11	0.06	0.08

Table A-5 (Continued)

TVA PLANT C RIVER WATER INTAKE AND COMBINED ASH POND (EAST) DISCHARGE DATA  
(Quarterly Samples)

Date	1/14/75		4/8/75		7/15/75		10/14/75	
	River Intake	Pond Discharge	River Intake	Pond Discharge	River Intake	Pond Discharge	River Intake	Pond Discharge
Aluminum, mg/l	15	0.4	8.5	1.0	1.3	0.6	0.6	1.4
Ammonia as N, mg/l	0.33	0.34	0.03	0.04	0.03	0.06	0.03	0.05
Arsenic, mg/l	<0.005	<0.005	<0.005	0.005	0.026	0.032	<0.005	0.010
Barium, mg/l	0.1	0.3	<0.1	<0.1	<0.1	<0.1	<0.1	<0.1
Beryllium, mg/l	<0.01	<0.01	<0.01	<0.01	<0.01	<0.01	<0.01	<0.01
Cadmium, mg/l	<0.001	0.007	0.002	0.013	<0.001	0.003	<0.001	0.002
Calcium, mg/l	20	59	17	88	43	68	45	66
Chloride, mg/l	9	9	7	7	11	12	15	16
Chromium, mg/l	<0.005	<0.005	0.013	<0.005	0.009	<0.005	<0.005	<0.005
Conductivity, 25°C, umhos/cm	20	480	200	480	360	5200	400	530
Copper, mg/l	0.03	0.04	0.13	0.09	0.10	0.05	0.09	0.07
Cyanide, mg/l	-	<0.01	-	-	-	-	-	-
Hardness, mg/l	80	180	69	250	160	220	150	230
Iron, mg/l	13	0.49	10	1.4	1.4	1.1	1.0	2.3
Lead, mg/l	0.028	0.030	0.047	0.021	<0.010	<0.010	<0.010	<0.010
Magnesium, mg/l	7.4	7.8	6.5	7.0	12	13	10	15
Manganese, mg/l	0.26	0.13	0.29	0.17	0.26	0.14	0.29	0.14
Mercury, mg/l	<0.0002	0.0220	<0.0002	No Bottle	<0.0002	<0.0002	<0.0002	<0.0002
Nickel, mg/l	<0.05	0.05	<0.05	<0.05	<0.05	<0.05	<0.05	<0.05
Phosphorous, mg/l	0.27	0.02	0.23	0.02	0.10	0.05	0.07	0.07
Selenium, mg/l	<0.002	<0.002	<0.002	<0.002	<0.002	<0.002	<0.001	0.002
Silica, mg/l	5.6	6.7	5.8	7.8	5.6	11	5.5	6.6
Silver, mg/l	<0.01	<0.01	<0.01	<0.01	<0.01	<0.01	<0.01	<0.01
Solids, Dissolved, mg/l	200	320	190	340	220	340	260	380
Solids, Suspended, mg/l	150	5	48	12	17	4	11	25
Sulfate, mg/l <sup>o</sup>	54	180	68	200	34	130	68	140
Zinc, mg/l	0.10	0.14	0.10	0.27	0.08	0.04	0.07	0.07

A-17

Table A-5 (Continued)

TVA PLANT C RIVER WATER INTAKE AND COMBINED ASH POND (EAST) DISCHARGE DATA  
(Quarterly Samples)

Date	1/8/76		4/13/76	
	River Intake	Pond Discharge	River Intake	Pond Discharge
Aluminum, mg/l	1.2	1.2	1.1	2.3
Ammonia as N, mg/l	0.15	0.20	0.03	0.06
Arsenic, mg/l	<0.005	0.010	0.005	<0.010
Barium, mg/l	<0.1	0.2	<0.1	0.3
Beryllium, mg/l	<0.01	<0.01	<0.01	<0.01
Cadmium, mg/l	<0.001	0.013	<0.001	0.010
Calcium, mg/l	35	61	24	43
Chloride, mg/l	13	12	8	9
Chromium, mg/l	<0.005	0.018	<0.005	<0.005
Conductivity, 25°C, umhos/cm	300	440	210	450
Copper, mg/l	0.09	0.05	0.05	0.19
Cyanide, mg/l	-	-	-	-
Hardness, mg/l	120	190	87	160
Iron, mg/l	3.7	1.9	1.8	3.4
Lead, mg/l	<0.010	<0.010	<0.010	0.014
Magnesium, mg/l	8.6	9.5	6.6	13
Manganese, mg/l	0.09	0.13	0.10	0.16
Mercury, mg/l	<0.0002	<0.0002	<0.0002	<0.0002
Nickel, mg/l	<0.05	<0.05	<0.05	<0.05
Phosphorous, mg/l	0.20	0.57	0.33	0.05
Selenium, mg/l	<0.002	<0.002	<0.002	<0.002
Silica, mg/l	7.3	7.1	10.0	9.5
Silver, mg/l	<0.01	<0.01	<0.01	<0.01
Solids, Dissolved, mg/l	130	310	170	300
Solids, Suspended, mg/l	32	20	58	18
Sulfate, mg/l	25	130	50	140
Zinc, mg/l	0.03	0.33	0.02	0.23

Table A-6

TVA PLANT C RIVER WATER INTAKE AND COMBINED ASH POND (WEST) DISCHARGE DATA  
(Quarterly Samples)

Date	1/73		4/73		7/3/73		9/30/73	
	River	Pond	River	Pond	River	Pond	River	Pond
	<u>Intake</u>	<u>Discharge</u>	<u>Intake</u>	<u>Discharge</u>	<u>Intake</u>	<u>Discharge</u>	<u>Intake</u>	<u>Discharge</u>
Aluminum, mg/l	NA	6.9	NA	*	NA	0.8	NA	1.2
Ammonia as N, mg/l	NA	0.07	NA	*	NA	0.02	NA	0.02
Arsenic, mg/l	NA	0.008	NA	*	NA	0.010	NA	0.035
Barium, mg/l	NA	<0.1	NA	*	NA	<0.1	NA	<0.1
Beryllium, mg/l	NA	<0.01	NA	*	NA	<0.01	NA	<0.01
Cadmium, mg/l	NA	<0.001	NA	*	NA	<0.001	NA	<0.001
Calcium, mg/l	NA	26	NA	*	NA	32	NA	40
Chloride, mg/l	NA	8	NA	*	NA	10	NA	14
Chromium, mg/l	NA	<0.005	NA	*	NA	<0.005	NA	0.005
Conductivity, 25°C, umhos/cm	NA	250	NA	*	NA	300	NA	380
Copper, mg/l	NA	<0.01	NA	*	NA	0.02	NA	<0.01
Cyanide, mg/l	NA	<0.01	NA	*	NA	<0.01	NA	<0.01
Hardness, mg/l	NA	92	NA	*	NA	130	NA	170
Iron, mg/l	NA	5.7	NA	*	NA	0.76	NA	0.97
Lead, mg/l	NA	<0.010	NA	*	NA	<0.010	NA	<0.010
Magnesium, mg/l	NA	6.6	NA	*	NA	12	NA	16
Manganese, mg/l	NA	0.15	NA	*	NA	0.09	NA	0.05
Mercury, mg/l	NA	0.0002	NA	*	NA	<0.011	NA	0.0002
Nickel, mg/l	NA	<0.05	NA	*	NA	<0.05	NA	<0.05
Phosphorous, mg/l	NA	0.57	NA	*	NA	0.21	NA	0.32
Selenium, mg/l	NA	<0.004	NA	*	NA	0.004	NA	<0.001
Silica, mg/l	NA	6.9	NA	*	NA	1.5	NA	2.7
Silver, mg/l	NA	<0.01	NA	*	NA	<0.01	NA	<0.01
Solids, Dissolved, mg/l	NA	170	NA	*	NA	180	NA	250
Solids, Suspended, mg/l	NA	57	NA	*	NA	11	NA	24
Sulfate, mg/l	NA	70	NA	*	NA	35	NA	60
Zinc, mg/l	NA	0.16	NA	*	NA	0.04	NA	0.03

NA = Not Available

\*Sample not collected due to high water of Mississippi River.

Table A-6 (Continued)

TVA PLANT C RIVER WATER INTAKE AND COMBINED ASH POND (WEST) DISCHARGE DATA  
(Quarterly Samples)

Date	1/15/74		4/9/74		7/16/74		10/8/74	
	River Intake	Pond Discharge	River Intake	Pond Discharge	River Intake	Pond Discharge	River Intake	Pond Discharge
Aluminum, mg/l	1.4	6.6	3.7	2.4	4.9	1.6	1.9	0.5
Ammonia as N, mg/l	0.28	0.18	0.03	<0.02	0.12	0.11	0.29	0.10
Arsenic, mg/l	0.010	0.010	<0.005	<0.005	<0.005	0.11	<0.005	<0.005
Barium, mg/l	0.1	0.1	0.2	0.3	0.2	0.2	0.2	0.1
Beryllium, mg/l	<0.01	<0.01	<0.01	<0.01	<0.01	<0.001	<0.01	<0.01
Cadmium, mg/l	<0.001	<0.001	<0.001	<0.001	<0.001	0.002	<0.001	0.004
Calcium, mg/l	15	19	70	26	28	27	38	89
Chloride, mg/l	9	10	12	11	10	10	16	14
Chromium, mg/l	0.041	0.014	<0.005	0.010	<0.005	<0.005	0.016	0.008
Conductivity, 25°C, umhos/cm	170	230	310	320	300	270	410	600
Copper, mg/l	0.22	<0.01	0.12	0.12	0.15	0.10	0.06	0.06
Cyanide, mg/l	-	0.01	-	<0.01	-	<0.01	-	-
Hardness, mg/l	65	73	110	100	110	100	150	280
Iron, mg/l	14	7.8	3.7	2.8	6.1	2.0	2.4	0.72
Lead, mg/l	0.032	0.033	0.02	<0.010	0.022	0.024	0.010	0.016
Magnesium, mg/l	6.8	6.3	9.4	8.9	9.8	9.0	14	14
Manganese, mg/l	0.34	0.20	0.12	0.07	0.38	0.11	0.53	0.34
Mercury, mg/l	<0.0002	0.0003	<0.0002	0.0041	0.0016	0.050	<0.0002	<0.0002
Nickel, mg/l	0.05	<0.05	<0.05	<0.05	<0.05	<0.05	<0.05	<0.05
Phosphorous, mg/l	0.49	0.30	0.28	0.13	0.29	-	0.06	0.02
Selenium, mg/l	0.004	0.002	<0.002	<0.002	<0.002	<0.002	<0.002	<0.002
Silica, mg/l	7.1	6.7	7.9	8.2	-	-	5.4	5.9
Silver, mg/l	<0.01	<0.01	<0.01	<0.01	<0.01	<0.01	<0.01	0.02
Solids, Dissolved, mg/l	170	180	160	170	200	-	240	390
Solids, Suspended, mg/l	38	27	32	29	31	19	39	4
Sulfate, mg/l	48	80	44	50	40	42	52	180
Zinc, mg/l	0.13	0.15	0.08	0.14	0.03	0.11	0.06	0.11

A-20

Table A-6 (Continued)

TVA PLANT C RIVER WATER INTAKE AND COMBINED ASH POND (WEST) DISCHARGE DATA  
(Quarterly Samples)

Date	1/14/75		4/22/75		7/15/75		River	Pond
	River	Pond	River	Pond	River	Pond		
	Intake	Discharge	Intake	Discharge	Intake	Discharge		
Aluminum, mg/l	15.0	8.0	8.5	3.2	1.3	2.3	Pond not in service. No sample collected.	
Ammonia as N, mg/l	0.33	0.22	0.03	0.11	0.03	0.12		
Arsenic, mg/l	<0.005	<0.005	<0.005	0.005	0.026	0.028		
Barium, mg/l	0.1	0.2	<0.1	<0.1	<0.1	<0.1		
Beryllium, mg/l	<0.01	<0.01	<0.01	<0.01	<0.01	<0.01		
Cadmium, mg/l	<0.001	0.001	0.002	<0.001	<0.001	0.010		
Calcium, mg/l	20	26	17	23	43	57		
Chloride, mg/l	9	9	7	8	11	11		
Chromium, mg/l	<0.005	<0.005	0.013	0.011	0.009	0.024		
Conductivity, 25°C, umhos/cm	20	260	200	320	360	630		
Copper, mg/l	0.03	0.02	0.13	0.04	0.10	0.18		
Cyanide, mg/l	-	<0.01	-	-	-	-		
Hardness, mg/l	80	95	69	85	160	200		
Iron, mg/l	13	8.5	10	3.3	1.4	24		
Lead, mg/l	0.028	0.030	0.047	<0.010	<0.010	0.015		
Magnesium, mg/l	7.4	7.2	6.5	6.7	12	13		
Manganese, mg/l	0.26	0.16	0.29	0.20	0.26	0.66		
Mercury, mg/l	<0.0002	*	<0.0002	<0.0002	<0.0002	<0.0002		
Nickel, mg/l	<0.05	<0.05	<0.05	0.06	<0.05	0.17		
Phosphorous, mg/l	0.27	0.20	0.23	0.08	0.10	0.01		
Selenium, mg/l	<0.002	<0.002	<0.002	0.003	<0.002	0.003		
Silica, mg/l	5.6	5.7	5.8	8.6	5.6	14		
Silver, mg/l	<0.01	<0.01	<0.01	<0.01	<0.01	<0.01		
Solids, Dissolved, mg/l	200	190	190	200	220	420		
Solids, Suspended, mg/l	150	98	48	24	17	13		
Sulfate, mg/l	54	65	68	130	34	280		
Zinc, mg/l	0.10	0.14	0.10	0.13	0.08	0.43		

\*Sample received broken.

Table A-6 (Continued)

TVA PLANT C RIVER WATER INTAKE AND COMBINED ASH POND (WEST) DISCHARGE DATA  
(Quarterly Samples)

Date	1/8/76	
	<u>River Intake</u>	<u>Pond Discharge</u>
Aluminum, mg/l	1.2	1.2
Ammonia as N, mg/l	0.15	0.20
Arsenic, mg/l	<0.005	0.010
Barium, mg/l	<0.1	0.2
Beryllium, mg/l	<0.01	<0.01
Cadmium, mg/l	<0.001	0.013
Calcium, mg/l	35	61
Chloride, mg/l	13	12
Chromium, mg/l	<0.005	0.018
Conductivity, 25°C, umhos/cm	300	440
Copper, mg/l	0.09	0.05
Cyanide, mg/l	-	-
Hardness, mg/l	120	190
Iron, mg/l	3.7	1.9
Lead, mg/l	<0.010	<0.010
Magnesium, mg/l	8.6	9.5
Manganese, mg/l	0.09	0.13
Mercury, mg/l	<0.0002	<0.0002
Nickel, mg/l	<0.05	<0.05
Phosphorous, mg/l	0.20	0.07
Selenium, mg/l	<0.002	<0.002
Silica, mg/l	7.3	7.1
Silver, mg/l	<0.01	<0.01
Solids, Dissolved, mg/l	130	310
Solids, Suspended, mg/l	32	20
Sulfate, mg/l	25	130
Zinc, mg/l	0.03	0.33



Table A-7

TVA PLANT D RIVER WATER INTAKE AND COMBINED ASH POND DISCHARGE DATA  
(Quarterly Samples)

Date	1/2/73		4/2/73		7/2/73		10/1/73	
	River Intake	Pond Discharge	River Intake	Pond Discharge	River Intake	Pond Discharge	River Intake	Pond Discharge
Aluminum, mg/l	NA	1.1	NA	1.3	NA	0.4	NA	2.6
Ammonia as N, mg/l	NA	0.15	NA	0.11	NA	0.01	NA	0.01
Arsenic, mg/l	NA	0.018	NA	0.025	NA	0.020	NA	0.050
Barium, mg/l	NA	0.2	NA	0.2	NA	0.2	NA	0.1
Beryllium, mg/l	NA	<0.01	NA	<0.01	NA	<0.01	NA	<0.01
Cadmium, mg/l	NA	0.001	NA	<0.001	NA	<0.001	NA	<0.001
Calcium, mg/l	NA	37	NA	33	NA	28	NA	34
Chloride, mg/l	NA	5	NA	4	NA	3	NA	3
Chromium, mg/l	NA	<0.005	NA	<0.005	NA	<0.005	NA	0.005
Conductivity, 25°C, umhos/cm	NA	310	NA	280	NA	210	NA	250
Copper, mg/l	NA	<0.01	NA	<0.01	NA	0.01	NA	<0.01
Cyanide, mg/l	NA	<0.01	NA	<0.01	NA	<0.01	NA	<0.01
Hardness, mg/l	NA	130	NA	120	NA	100	NA	110
Iron, mg/l	NA	0.17	NA	0.27	NA	0.08	NA	0.39
Lead, mg/l	NA	<0.010	NA	<0.010	NA	<0.010	NA	<0.010
Magnesium, mg/l	NA	9.0	NA	8.4	NA	7.8	NA	8.9
Manganese, mg/l	NA	0.04	NA	0.05	NA	0.01	NA	0.02
Mercury, mg/l	NA	0.001	NA	0.0002	NA	0.0003	NA	<0.0002
Nickel, mg/l	NA	<0.05	NA	<0.05	NA	<0.05	NA	0.19
Phosphorous, mg/l	NA	0.07	NA	0.04	NA	0.06	NA	0.15
Selenium, mg/l	NA	0.140	NA	>0.050	NA	0.050	NA	0.056
Silica, mg/l	NA	3.2	NA	3.8	NA	1.0	NA	5.0
Silver, mg/l	NA	<0.01	NA	<0.01	NA	<0.01	NA	<0.01
Solids, Dissolved, mg/l	NA	200	NA	100	NA	120	NA	170
Solids, Suspended, mg/l	NA	8	NA	14	NA	3	NA	33
Sulfate, mg/l	NA	84	NA	60	NA	35	NA	52
Zinc, mg/l	NA	0.01	NA	0.01	NA	<0.01	NA	0.01

A-23  
NA = Not Available

Table A-7 (Continued)

TVA PLANT D RIVER WATER INTAKE AND COMBINED ASH POND DISCHARGE DATA  
(Quarterly Samples)

Date	1/15/74		4/22/74		7/16/74		10/7/74	
	River Intake	Pond Discharge	River Intake	Pond Discharge	River Intake	Pond Discharge	River Intake	Pond Discharge
Aluminum, mg/l	0.9	0.3	0.2	2.9	0.4	0.6	0.4	1.8
Ammonia as N, mg/l	0.01	0.14	<0.01	<0.01	0.01	0.06	0.13	0.04
Arsenic, mg/l	<0.005	0.010	<0.005	0.045	<0.005	0.025	<0.005	0.050
Barium, mg/l	0.2	<0.1	0.2	0.3	0.2	0.2	0.1	0.2
Beryllium, mg/l	<0.01	<0.01	<0.01	<0.01	<0.01	<0.01	<0.01	<0.01
Cadmium, mg/l	<0.001	<0.001	<0.001	<0.001	<0.001	0.002	<0.001	<0.001
Calcium, mg/l	27	26	28	30	26	31	31	34
Chloride, mg/l	4	4	3	4	3	3	3	3
Chromium, mg/l	<0.005	<0.005	<0.005	<0.005	<0.005	<0.005	<0.005	0.008
Conductivity, 25°C, umhos/cm	150	920	200	240	220	270	240	300
Copper, mg/l	0.22	<0.01	0.03	0.04	0.02	<0.01	0.04	0.04
Cyanide, mg/l	-	<0.01	-	<0.01	-	<0.01	-	-
Hardness, mg/l	100	96	100	110	97	110	110	120
Iron, mg/l	1.00	0.14	0.41	0.55	0.57	0.15	0.33	0.28
Lead, mg/l	0.016	<0.010	<0.010	<0.010	<0.010	0.020	<0.010	0.016
Magnesium, mg/l	8.4	7.5	7.7	7.6	7.8	8.1	8.8	8.8
Manganese, mg/l	0.10	0.05	0.03	0.02	0.05	<0.01	0.13	0.02
Mercury, mg/l	0.0005	<0.0002	<0.0002	<0.0002	<0.0002	<0.0002	<0.0002	<0.0002
Nickel, mg/l	0.27	0.05	<0.05	<0.05	<0.05	<0.05	<0.05	<0.05
Phosphorous, mg/l	<0.01	<0.01	0.02	0.02	0.01	-	0.01	0.08
Selenium, mg/l	0.004	0.098	<0.002	<0.002	<0.002	0.110	<0.002	0.016
Silica, mg/l	3.8	3.6	4.4	4.4	-	-	4.7	4.8
Silver, mg/l	<0.01	<0.01	<0.01	<0.01	<0.01	<0.01	<0.01	<0.01
Solids, Dissolved, mg/l	130	160	120	150	120	-	130	180
Solids, Suspended, mg/l	13	7	8	45	10	6	6	19
Sulfate, mg/l	14	70	16	16	13	80	14	72
Zinc, mg/l	0.07	<0.01	0.07	0.07	0.03	0.06	0.03	0.04

A-24

Table A-7 (Continued)

TVA PLANT D RIVER WATER INTAKE AND COMBINED ASH POND DISCHARGE DATA  
(Quarterly Samples)

Date	1/13/75		4/7/75		7/14/75		10/14/75	
	River	Pond	River	Pond	River	Pond	River	Pond
	Intake	Discharge	Intake	Discharge	Intake	Discharge	Intake	Discharge
Aluminum, mg/l	*	0.6	0.5	3.8	0.7	1.6	0.5	<0.2
Ammonia as N, mg/l	0.06	0.04	0.04	0.04	0.02	0.02	0.07	0.04
Arsenic, mg/l	<0.005	<0.005	<0.005	0.055	<0.005	0.100	<0.005	<0.005
Barium, mg/l	*	0.1	<0.1	<0.1	<0.1	<0.1	<0.1	<0.1
Beryllium, mg/l	*	<0.01	<0.01	<0.01	<0.01	<0.01	<0.01	<0.01
Cadmium, mg/l	*	0.001	<0.001	0.001	<0.001	0.001	<0.001	<0.001
Calcium, mg/l	*	33	23	26	29	32	30	31
Chloride, mg/l	3	3	3	3	2	2	*	3
Chromium, mg/l	*	<0.005	<0.005	0.006	<0.005	<0.005	<0.005	<0.005
Conductivity, 25°C, umhos/cm	220	280	220	260	200	250	*	260
Copper, mg/l	*	0.01	0.06	0.05	0.05	0.14	0.09	0.07
Cyanide, mg/l	-	<0.01	-	-	-	-	-	-
Hardness, mg/l	*	120	87	96	100	110	110	120
Iron, mg/l	*	0.09	0.47	0.67	0.56	<0.05	0.25	0.33
Lead, mg/l	*	0.046	0.018	0.028	<0.010	<0.010	0.011	<0.010
Magnesium, mg/l	*	8.3	7.2	7.5	7.1	8.2	9.1	9.8
Manganese, mg/l	*	0.03	0.05	0.03	0.07	0.02	0.09	0.04
Mercury, mg/l	*	<0.0002	<0.0002	<0.0002	<0.0002	<0.0002	<0.0002	<0.0002
Nickel, mg/l	*	<0.05	<0.05	<0.05	<0.05	<0.05	<0.05	<0.05
Phosphorous, mg/l	0.05	0.02	0.01	0.07	0.04	0.03	0.02	0.02
Selenium, mg/l	<0.002	0.130	<0.002	0.170	<0.002	0.010	<0.002	0.010
Silica, mg/l	4.4	3.3	5.2	5.0	9.5	6.2	4.5	4.3
Silver, mg/l	*	<0.01	<0.01	<0.01	<0.01	<0.01	<0.01	<0.01
Solids, Dissolved, mg/l	140	170	130	160	110	150	*	160
Solids, Suspended, mg/l	55	6	6	31	1	8	*	4
Sulfate, mg/l	18	65	20	58	15	60	*	31
Zinc, mg/l	*	0.04	0.03	0.05	0.03	0.03	0.04	0.03

\*Bottle received broken.

Table A-7 (Continued)

TVA PLANT D RIVER WATER INTAKE AND COMBINED ASH POND DISCHARGE DATA  
(Quarterly Samples)

Date	1/12/76		4/12/76	
	River Intake	Pond Discharge	River Intake	Pond Discharge
Aluminum, mg/l	0.2	0.8	0.5	0.3
Ammonia as N, mg/l	0.02	0.12	0.03	0.09
Arsenic, mg/l	<0.005	0.025	<0.005	0.030
Barium, mg/l	<0.1	<0.1	<0.1	0.5
Beryllium, mg/l	<0.01	<0.01	<0.01	<0.01
Cadmium, mg/l	<0.001	0.001	<0.001	<0.001
Calcium, mg/l	32	50	34	55
Chloride, mg/l	4	4	4	4
Chromium, mg/l	<0.005	0.012	<0.005	<0.005
Conductivity, 25°C, umhos/cm	240	340	240	370
Copper, mg/l	<0.01	<0.01	0.01	0.03
Cyanide, mg/l	-	-	-	-
Hardness, mg/l	110	160	120	170
Iron, mg/l	0.18	0.29	0.36	0.32
Lead, mg/l	<0.010	<0.010	<0.010	<0.010
Magnesium, mg/l	8.5	8.8	8.6	8.5
Manganese, mg/l	0.04	0.08	0.07	0.02
Mercury, mg/l	<0.0002	<0.0002	<0.0002	<0.0002
Nickel, mg/l	<0.05	<0.05	<0.05	<0.05
Phosphorous, mg/l	0.01	0.04	0.02	0.03
Selenium, mg/l	<0.002	0.026	<0.002	0.020
Silica, mg/l	2.3	3.9	3.0	3.2
Silver, mg/l	<0.01	<0.01	<0.01	<0.01
Solids, Dissolved, mg/l	130	220	110	230
Solids, Suspended, mg/l	4	10	1	3
Sulfate, mg/l	19	89	11	120
Zinc, mg/l	0.02	<0.01	0.05	0.01

Table A-8

TVA PLANT E RIVER WATER INTAKE AND COMBINED ASH POND DISCHARGE DATA  
(Quarterly Samples)

Date	1/4/73		4/2/73		7/3/73		10/1/73	
	River Intake	Pond Discharge	River Intake	Pond Discharge	River Intake	Pond Discharge	River Intake	Pond Discharge
Aluminum, mg/l	NA	1.5	NA	11	NA	2.9	NA	3.4
Ammonia as N, mg/l	NA	0.07	NA	0.08	NA	0.07	NA	0.23
Arsenic, mg/l	NA	0.005	NA	0.010	NA	0.010	NA	0.005
Barium, mg/l	NA	0.1	NA	0.4	NA	0.2	NA	0.4
Beryllium, mg/l	NA	<0.01	NA	<0.01	NA	<0.01	NA	<0.01
Cadmium, mg/l	NA	<0.001	NA	0.002	NA	<0.001	NA	<0.001
Calcium, mg/l	NA	230	NA	340	NA	210	NA	300
Chloride, mg/l	NA	8	NA	6	NA	5	NA	8
Chromium, mg/l	NA	0.015	NA	0.026	NA	0.027	NA	0.020
Conductivity, 25°C, umhos/cm	NA	1,200	NA	1,400	NA	950	NA	1,600
Copper, mg/l	NA	<0.01	NA	<0.01	NA	0.01	NA	0.20
Cyanide, mg/l	NA	<0.01	NA	<0.01	NA	<0.01	NA	<0.01
Hardness, mg/l	NA	580	NA	850	NA	530	NA	800
Iron, mg/l	NA	0.17	NA	3.6	NA	0.29	NA	0.20
Lead, mg/l	NA	<0.010	NA	<0.010	NA	<0.010	NA	<0.010
Magnesium, mg/l	NA	0.6	NA	0.9	NA	0.5	NA	11
Manganese, mg/l	NA	<0.01	NA	0.06	NA	<0.01	NA	<0.01
Mercury, mg/l	NA	0.0002	NA	0.0002	NA	<0.0002	NA	<0.0002
Nickel, mg/l	NA	<0.05	NA	<0.05	NA	<0.05	NA	<0.05
Phosphorous, mg/l	NA	0.06	NA	0.03	NA	0.04	NA	<0.03
Selenium, mg/l	NA	0.008	NA	0.024	NA	0.010	NA	0.016
Silica, mg/l	NA	5.0	NA	5.0	NA	6.2	NA	5.7
Silver, mg/l	NA	<0.01	NA	<0.01	NA	<0.01	NA	<0.01
Solids, Dissolved, mg/l	NA	540	NA	680	NA	420	NA	680
Solids, Suspended, mg/l	NA	6	NA	150	NA	6	NA	8
Sulfate, mg/l	NA	180	NA	230	NA	22	NA	220
Zinc, mg/l	NA	0.07	NA	0.11	NA	0.02	NA	0.01

A-27  
NA = Not Available

Table A-8 (Continued)

TVA PLANT E RIVER WATER INTAKE AND COMBINED ASH POND DISCHARGE DATA  
(Quarterly Samples)

Date	1/15/74		4/9/74		7/16/74		10/16/74	
	River Intake	Pond Discharge	River Intake	Pond Discharge	River Intake	Pond Discharge	River Intake	Pond Discharge
Aluminum, mg/l	2.7	2.0	3.2	4.5	0.6	1.3	0.5	2.1
Ammonia as N, mg/l	0.06	0.06	0.06	0.06	0.07	0.05	-	0.03
Arsenic, mg/l	0.005	<0.005	<0.005	<0.005	<0.005	<0.005	0.005	<0.005
Barium, mg/l	0.2	<0.1	<0.1	0.4	0.2	0.3	<0.1	0.3
Beryllium, mg/l	<0.01	<0.01	<0.01	<0.01	<0.01	<0.01	<0.01	<0.01
Cadmium, mg/l	<0.001	<0.001	<0.001	<0.001	<0.001	0.003	0.001	<0.001
Calcium, mg/l	17	160	19	200	17	64	20	98
Chloride, mg/l	5	5	5	6	6	4	9	9
Chromium, mg/l	0.02	0.011	<0.005	0.039	-	-	<0.005	0.017
Conductivity, 25°C, umhos/cm	130	270	160	1,500	160	660	180	670
Copper, mg/l	0.13	<0.01	0.11	0.10	0.06	0.07	0.12	0.10
Cyanide, mg/l	-	<0.01	-	<0.01	-	<0.01	-	-
Hardness, mg/l	57	400	61	500	58	160	68	250
Iron, mg/l	2.40	0.16	0.94	0.95	-	-	0.18	0.20
Lead, mg/l	0.016	0.008	<0.01	<0.010	0.024	0.068	0.010	0.012
Magnesium, mg/l	3.6	0.2	3.4	0.3	3.9	1.1	4.5	0.3
Manganese, mg/l	0.1	<0.1	0.24	0.02	0.05	<0.01	0.07	0.02
Mercury, mg/l	<0.0002	<0.0002	<0.0002	<0.0002	0.0006	0.0003	<0.0002	-
Nickel, mg/l	<0.05	<0.05	<0.05	<0.05	<0.05	<0.05	<0.05	<0.05
Phosphorous, mg/l	0.08	<0.01	0.08	0.02	0.05	-	0.09	0.01
Selenium, mg/l	<0.001	0.020	<0.002	0.011	-	-	<0.002	<0.002
Silica, mg/l	5.2	5.6	4.4	5.0	-	-	5.8	6.9
Silver, mg/l	<0.01	<0.01	<0.01	<0.01	<0.01	<0.01	<0.01	<0.01
Solids, Dissolved, mg/l	80	310	90	580	-	-	110	260
Solids, Suspended, mg/l	9	10	27	37	4	23	2	5
Sulfate, mg/l	15	150	20	170	-	-	12	70
Zinc, mg/l	0.08	<0.01	0.08	0.08	0.07	0.07	0.05	0.06

A-28

Table A-8 (Continued)

TVA PLANT E RIVER WATER INTAKE AND COMBINED ASH POND DISCHARGE DATA  
(Quarterly Samples)

Date	1/14/75		4/7/75		7/14/75		10/14/75	
	River Intake	Pond Discharge	River Intake	Pond Discharge	River Intake	Pond Discharge	River Intake	Pond Discharge
Aluminum, mg/l	4.3	1.1	3.6	3.0	1.7	2.9	1.9	2.4
Ammonia as N, mg/l	0.07	0.05	0.07	0.09	0.04	0.04	0.10	0.05
Arsenic, mg/l	<0.005	<0.005	<0.005	<0.005	<0.005	0.010	<0.005	0.130
Barium, mg/l	<0.1	<0.1	0.2	0.3	0.2	<0.1	<0.1	<0.1
Beryllium, mg/l	<0.01	<0.01	<0.01	<0.01	<0.01	<0.01	<0.01	<0.01
Cadmium, mg/l	<0.001	<0.001	0.002	0.002	<0.001	<0.001	<0.001	<0.001
Calcium, mg/l	18	68	14	170	20	140	16	130
Chloride, mg/l	6	7	4	5	5	5	6	8
Chromium, mg/l	<0.005	0.020	<0.005	0.020	<0.005	0.021	<0.005	<0.005
Conductivity, 25°C, umhos/cm	160	420	140	690	160	840	150	680
Copper, mg/l	0.02	0.02	0.03	0.02	0.08	0.19	0.07	0.11
Cyanide, mg/l	-	<0.01	-	-	-	-	-	-
Hardness, mg/l	57	170	48	430	67	350	54	330
Iron, mg/l	1.6	0.07	1.2	0.05	0.57	0.39	0.45	0.28
Lead, mg/l	0.028	0.022	<0.010	0.015	<0.010	<0.010	0.010	<0.010
Magnesium, mg/l	3.0	0.3	3.1	0.4	4.1	0.1	3.4	0.3
Manganese, mg/l	0.06	<0.01	0.04	<0.01	0.07	<0.01	0.04	0.02
Mercury, mg/l	<0.0002	<0.0002	<0.0002	<0.0002	<0.0002	<0.0002	<0.0002	<0.0002
Nickel, mg/l	<0.05	<0.05	<0.05	<0.05	<0.05	<0.05	<0.05	<0.05
Phosphorous, mg/l	0.09	0.01	0.06	0.01	0.07	<0.01	0.09	0.01
Selenium, mg/l	<0.002	<0.002	<0.002	0.014	<0.002	0.008	<0.001	0.010
Silica, mg/l	4.7	5.9	5.0	6.9	4.6	8.4	4.5	7.6
Silver, mg/l	<0.01	<0.01	<0.01	<0.01	<0.01	<0.01	<0.01	<0.01
Solids, Dissolved, mg/l	100	240	80	350	90	420	100	420
Solids, Suspended, mg/l	38	3	8	6	11	5	16	3
Sulfate, mg/l	25	100	20	170	19	130	15	130
Zinc, mg/l	0.04	0.03	0.18	0.07	0.04	0.03	0.07	0.04

A-29

Table A-8 (Continued)

TVA PLANT E RIVER WATER INTAKE AND COMBINED ASH POND DISCHARGE DATA  
(Quarterly Samples)

Date	1/19/76		4/12/76	
	<u>River Intake</u>	<u>Pond Discharge</u>	<u>River Intake</u>	<u>Pond Discharge</u>
Aluminum, mg/l	2.1	1.5	1.4	1.0
Ammonia as N, mg/l	0.13	0.09	0.10	0.84
Arsenic, mg/l	<0.005	<0.010	<0.005	0.010
Barium, mg/l	<0.1	0.3	<0.1	<0.1
Beryllium, mg/l	<0.01	<0.01	<0.01	<0.01
Cadmium, mg/l	<0.001	<0.001	<0.001	<0.010
Calcium, mg/l	22	140	26	110
Chloride, mg/l	7	6	6	6
Chromium, mg/l	<0.005	0.013	<0.005	0.007
Conductivity, 25°C, umhos/cm	150	650	180	600
Copper, mg/l	<0.01	<0.01	0.02	0.02
Cyanide, mg/l	-	-	-	-
Hardness, mg/l	69	350	79	280
Iron, mg/l	0.45	0.18	0.40	0.17
Lead, mg/l	<0.010	<0.010	<0.010	<0.010
Magnesium, mg/l	3.5	0.3	3.5	0.1
Manganese, mg/l	0.04	<0.01	0.04	0.02
Mercury, mg/l	<0.0002	<0.0002	<0.0002	0.0003
Nickel, mg/l	<0.05	<0.05	<0.05	<0.05
Phosphorous, mg/l	0.08	0.02	0.06	0.01
Selenium, mg/l	<0.002	<0.002	<0.002	0.005
Silica, mg/l	4.9	7.3	3.7	7.0
Silver, mg/l	<0.01	<0.01	<0.01	<0.01
Solids, Dissolved, mg/l	100	280	90	280
Solids, Suspended, mg/l	14	18	10	2
Sulfate, mg/l	14	83	19	93
Zinc, mg/l	<0.01	<0.01	<0.01	0.09



Table A-9

TVA PLANT F RIVER WATER INTAKE AND COMBINED ASH POND DISCHARGE DATA  
(Quarterly Samples)

Date	1/1/73		3/28/73		7/13/73		10/16/73	
	River Intake	Pond Discharge	River Intake	Pond Discharge	River Intake	Pond Discharge	River Intake	Pond Discharge
Aluminum, mg/l	NA	1.0	NA	2.2	NA	1.8	NA	2.5
Ammonia as N, mg/l	NA	0.06	NA	0.03	NA	0.06	NA	0.12
Arsenic, mg/l	NA	<0.005	NA	0.005	NA	<0.005	NA	<0.005
Barium, mg/l	NA	<0.1	NA	<0.1	NA	<0.1	NA	0.3
Beryllium, mg/l	NA	<0.01	NA	<0.01	NA	<0.01	NA	<0.01
Cadmium, mg/l	NA	<0.001	NA	<0.001	NA	<0.001	NA	<0.001
Calcium, mg/l	NA	100	NA	74	NA	140	NA	140
Chloride, mg/l	NA	5	NA	5	NA	4	NA	6
Chromium, mg/l	NA	0.030	NA	0.012	NA	0.059	NA	0.040
Conductivity, 25°C, umhos/cm	NA	410	NA	350	NA	650	NA	700
Copper, mg/l	NA	<0.01	NA	<0.01	NA	<0.01	NA	0.02
Cyanide, mg/l	NA	<0.01	NA	<0.01	NA	<0.01	NA	<0.01
Hardness, mg/l	NA	260	NA	200	NA	350	NA	380
Iron, mg/l	NA	0.19	NA	1.1	NA	<0.05	NA	<0.05
Lead, mg/l	NA	<0.010	NA	<0.010	NA	<0.010	NA	<0.010
Magnesium, mg/l	NA	3.1	NA	2.7	NA	0.3	NA	7.2
Manganese, mg/l	NA	<0.01	NA	0.04	NA	<0.01	NA	<0.01
Mercury, mg/l	NA	0.0009	NA	<0.0002	NA	0.0003	NA	0.0003
Nickel, mg/l	NA	<0.05	NA	<0.05	NA	<0.05	NA	<0.05
Phosphorous, mg/l	NA	0.14	NA	0.24	NA	0.03	NA	0.03
Selenium, mg/l	NA	0.024	NA	0.009	NA	0.016	NA	0.010
Silica, mg/l	NA	4.8	NA	4.2	NA	5.9	NA	7.6
Silver, mg/l	NA	<0.01	NA	<0.01	NA	<0.01	NA	<0.01
Solids, Dissolved, mg/l	NA	320	NA	230	NA	390	NA	380
Solids, Suspended, mg/l	NA	1	NA	20	NA	2	NA	2
Sulfate, mg/l	NA	140	NA	120	NA	180	NA	230
Zinc, mg/l	NA	0.03	NA	0.01	NA	<0.01	NA	<0.01

NA = Not Available

Table A-9 (Continued)

TVA PLANT F RIVER WATER INTAKE AND COMBINED ASH POND DISCHARGE DATA  
(Quarterly Samples)

Date	2/27/74		1/28/74		4/16/74		7/15/74		10/22/74	
	River	Pond	River	Pond	River	Pond	River	Pond	River	Pond
	Intake	Discharge	Intake	Discharge	Intake	Discharge	Intake	Discharge	Intake	Discharge
Aluminum, mg/l	3.6	0.8	1.3	1.4	NA	3.1	<0.1	3.0		
Ammonia as N, mg/l	0.03	0.38	0.03	0.26	NA	0.10	0.26	0.17		
Arsenic, mg/l	<0.005	<0.005	<0.005	<0.005	NA	<0.005	<0.006	<0.005		
Barium, mg/l	<0.10	<0.1	0.2	0.5	NA	0.1	<0.1	0.4		
Beryllium, mg/l	<0.01	<0.01	<0.01	<0.91	NA	<0.01	<0.01	<0.01		
Cadmium, mg/l	<0.001	<0.001	<0.001	<0.001	NA	0.002	<0.001	<0.001		
Calcium, mg/l	26	80	23	98	NA	130	35	160		
Chloride, mg/l	4	4	3	5	NA	4	4	5		
Chromium, mg/l	<0.005	0.050	0.012	0.040	NA	0.044	<0.005	0.072		
Conductivity, 25°C, umhos/cm	170	480	150	500	NA	1,100	250	780		
Copper, mg/l	<0.01	0.04	0.07	0.04	NA	<0.01	0.02	0.01		
Cyanide, mg/l	-	<0.01	-	<0.01	NA	<0.01	-	-		
Hardness, mg/l	81	200	75	250	NA	330	100q	400		
Iron, mg/l	1.1	0.11	1.4	0.13	NA	<0.05	0.36	0.23		
Lead, mg/l	<0.010	<0.010	0.032	<0.010	NA	0.040	<0.010	<0.010		
Magnesium, mg/l	4.0	1.2	4.3	0.7	NA	0.2	4.2	0.2		
Manganese, mg/l	0.06	<0.01	0.08	<0.01	NA	<0.01	0.03	<0.01		
Mercury, mg/l	0.0033	<0.0002	<0.0002	<0.0002*	NA	0.3	<0.0002	<0.0002		
Nickel, mg/l	<0.05	<0.05	<0.05	<0.05	NA	<0.05	<0.05	<0.05		
Phosphorous, mg/l	0.10	0.03	0.11	0.02	NA	<0.01	0.15	<0.01		
Selenium, mg/l	<0.002	0.012	<0.002	0.018	NA	0.028	<0.002	0.012		
Silica, mg/l	5.4	6.0	4.9	6.8	NA		4.5	7.6		
Silver, mg/l	<0.01	<0.01	<0.01	<0.01	NA	<0.01	<0.01	<0.01		
Solids, Dissolved, mg/l	90	280	110	350	NA	540	150	450		
Solids, Suspended, mg/l	26	<1	28	2	NA	2	6	<1		
Sulfate, mg/l	20	120	19	14	NA	200	19	240		
Zinc, mg/l	0.18	0.08	0.22	0.06	NA	0.03	0.13	0.06		

NA = Not Available

\*Collected 4/22/74.

Table A-9 (Continued)

TVA PLANT F RIVER WATER INTAKE AND COMBINED ASH POND DISCHARGE DATA  
(Quarterly Samples)

Date	1/20/75		4/7/75		7/15/75		10/14/75	
	River	Pond	River	Pond	River	Pond	River	Pond
	Intake	Discharge	Intake	Discharge	Intake	Discharge	Intake	Discharge
Aluminum, mg/l	1.3	1.5	2.3	0.9	1.0	1.0	<0.2	1.4
Ammonia as N, mg/l	0.03	0.30	0.05	0.42	0.07	0.03	0.10	0.06
Arsenic, mg/l	<0.005	<0.005	<0.005	<0.005	<0.005	<0.005	<0.005	0.040
Barium, mg/l	<0.1	0.2	<0.1	<0.1	<0.1	<0.1	<0.1	<0.1
Beryllium, mg/l	<0.01	<0.01	<0.01	<0.01	<0.01	<0.01	<0.01	<0.01
Cadmium, mg/l	0.002	<0.001	0.001	0.001	<0.001	<0.001	0.001	<0.001
Calcium, mg/l	28	85	19	100	31	67	30	110
Chloride, mg/l	4	5	3	5	4	4	4	6
Chromium, mg/l	<0.005	<0.005	0.005	0.020	<0.005	0.020	<0.005	<0.005
Conductivity, 25°C, umhos/cm	220	780	150	400	190	460	210	660
Copper, mg/l	0.05	0.08	0.04	0.06	0.08	0.07	0.05	0.04
Cyanide, mg/l	-	<0.01	-	-	-	-	-	-
Hardness, mg/l	86	210	62	260	96	170	95	280
Iron, mg/l	1.1	0.10	2.1	0.37	0.97	0.12	0.29	0.10
Lead, mg/l	0.052	<0.010	0.010	0.015	<0.010	<0.010	<0.010	0.010
Magnesium, mg/l	3.8	0.3	3.5	1.6	4.4	0.7	4.9	0.6
Manganese, mg/l	0.07	<0.01	0.11	0.01	0.07	0.01	0.07	0.01
Mercury, mg/l	<0.0002	<0.0002	<0.0002	<0.0002	<0.0002	<0.0002	<0.0002	<0.0002
Nickel, mg/l	<0.05	<0.05	<0.05	<0.05	<0.05	<0.05	<0.05	<0.05
Phosphorous, mg/l	0.11	<0.01	0.10	0.03	0.17	0.02	0.16	0.02
Selenium, mg/l	<0.002	0.010	<0.002	0.008	<0.002	0.010	<0.001	0.006
Silica, mg/l	4.1	5.8	4.8	3.9	4.4	6.6	3.5	6.5
Silver, mg/l	<0.01	<0.01	<0.01	<0.01	<0.01	<0.01	<0.01	<0.01
Solids, Dissolved, mg/l	140	450	130	300	110	270	170	430
Solids, Suspended, mg/l	35	3	42	11	27	4	15	4
Sulfate, mg/l	18	260	22	140	23	120	12	160
Zinc, mg/l	0.06	0.07	0.06	0.04	0.13	0.14	0.03	0.02

A-33

Table A-9 (Continued)

TVA PLANT F RIVER WATER INTAKE AND COMBINED ASH POND DISCHARGE DATA  
(Quarterly Samples)

Date	1/13/76		4/13/76	
	River	Pond	River	Pond
	<u>Intake</u>	<u>Discharge</u>	<u>Intake</u>	<u>Discharge</u>
Aluminum, mg/l	0.6	1.9	1.3	1.0
Ammonia as N, mg/l	0.07	0.27	0.03	0.11
Arsenic, mg/l	<0.005	<0.005	<0.005	<0.005
Barium, mg/l	<0.1	0.2	<0.1	<0.1
Beryllium, mg/l	<0.01	<0.01	<0.01	<0.01
Cadmium, mg/l	<0.001	0.001	<0.001	<0.001
Calcium, mg/l	35	130	29	110
Chloride, mg/l	4	6	4	4
Chromium, mg/l	<0.005	0.058	<0.005	0.022
Conductivity, 25°C, umhos/cm	220	580	180	550
Copper, mg/l	<0.01	0.02	0.01	0.02
Cyanide, mg/l	-	-	-	-
Hardness, mg/l	100	330	91	280
Iron, mg/l	0.73	0.31	1.6	0.24
Lead, mg/l	<0.010	<0.010	<0.010	<0.010
Magnesium, mg/l	3.5	0.6	4.4	1.0
Manganese, mg/l	0.06	<0.01	0.08	0.01
Mercury, mg/l	<0.0002	<0.0002	<0.0002	<0.0002
Nickel, mg/l	<0.05	<0.05	<0.05	<0.05
Phosphorous, mg/l	0.09	0.02	0.10	<0.01
Selenium, mg/l	<0.004	<0.004	<0.002	0.005
Silica, mg/l	4.6	4.9	4.9	5.6
Silver, mg/l	<0.01	<0.01	<0.01	<0.01
Solids, Dissolved, mg/l	120	390	110	380
Solids, Suspended, mg/l	21	53	18	1
Sulfate, mg/l	17	220	13	170
Zinc, mg/l	0.02	0.06	0.16	<0.01

Table A-10

TVA PLANT G RIVER WATER INTAKE AND COMBINED ASH POND DISCHARGE DATA  
(Quarterly Samples)

Date	1/4/73*		4/2/73*		7/2/73		10/1/73	
	River Intake	Pond Discharge	River Intake	Pond Discharge	River Intake	Pond Discharge	River Intake	Pond Discharge
Aluminum, mg/l	NA	1.1	NA	2.4	NA	2.9	NA	2.6
Ammonia as N, mg/l	NA	0.38	NA	0.04	NA	0.10	NA	0.01
Arsenic, mg/l	NA	0.004	NA	<0.005	NA	0.010	NA	0.070
Barium, mg/l	NA	0.4	NA	<0.1	NA	0.1	NA	<0.1
Beryllium, mg/l	NA	<0.01	NA	<0.01	NA	<0.01	NA	<0.01
Cadmium, mg/l	NA	0.005	NA	<0.001	NA	<0.001	NA	<0.001
Calcium, mg/l	NA	240	NA	25	NA	110	NA	72
Chloride, mg/l	NA	8	NA	4	NA	4	NA	4
Chromium, mg/l	NA	<0.005	NA	<0.005	NA	0.023	NA	0.009
Conductivity, 25°C, umhos/cm	NA	1,000	NA	180	NA	390	NA	360
Copper, mg/l	NA	0.04	NA	0.04	NA	<0.01	NA	<0.01
Cyanide, mg/l	NA	<0.01	NA	<0.01	NA	0.02	NA	<0.01
Hardness, mg/l	NA	660	NA	81	NA	280	NA	190
Iron, mg/l	NA	72	NA	4.6	NA	0.42	NA	0.30
Lead, mg/l	NA	<0.010	NA	<0.010	NA	<0.010	NA	<0.010
Magnesium, mg/l	NA	14	NA	4.6	NA	1.1	NA	1.9
Manganese, mg/l	NA	1.6	NA	0.23	NA	0.03	NA	0.02
Mercury, mg/l	NA	0.001	NA	-	NA	<0.0002	NA	-
Nickel, mg/l	NA	0.14	NA	<0.05	NA	<0.05	NA	<0.05
Phosphorous, mg/l	NA	0.03	NA	0.03	NA	0.12	NA	0.21
Selenium, mg/l	NA	0.008	NA	-	NA	0.015	NA	<0.001
Silica, mg/l	NA	11	NA	4.9	NA	5.1	NA	5.7
Silver, mg/l	NA	<0.01	NA	<0.01	NA	<0.01	NA	<0.01
Solids, Dissolved, mg/l	NA	1,100	NA	160	NA	300	NA	270
Solids, Suspended, mg/l	NA	14	NA	37	NA	8	NA	17
Sulfate, mg/l	NA	980	NA	55	NA	140	NA	88
Zinc, mg/l	NA	0.59	NA	0.02	NA	0.02	NA	0.01

NA = Not Available

\*Old ash pond containing coal pile drainage only. Sampling of old pond discontinued after April 2, 1973 sample. Quarterly samples beginning July 2, 1973 are of new ash pond.

Table A-10 (Continued)

TVA PLANT G RIVER WATER INTAKE AND COMBINED ASH POND DISCHARGE DATA  
(Quarterly Samples)

Date	1/14/74		4/15/74		7/15/74		10/21/74	
	River Intake	Pond Discharge	River Intake	Pond Discharge	River Intake	Pond Discharge	River Intake	Pond Discharge
Aluminum, mg/l	4.1	1.4	0.8	1.7	0.4	0.5	0.1	0.4
Ammonia as N, mg/l	0.03	0.01	0.02	0.10	0.08	0.01	0.03	0.01
Arsenic, mg/l	<0.005	<0.005	<0.005	<0.030	<0.005	0.055	<0.005	0.030
Barium, mg/l	0.1	<0.1	0.1	0.1	0.1	0.2	<0.1	0.3
Beryllium, mg/l	<0.01	<0.01	<0.01	<0.01	<0.01	<0.01	<0.01	<0.01
Cadmium, mg/l	<0.001	<0.001	<0.001	<0.001	<0.001	<0.001	<0.001	<0.001
Calcium, mg/l	21	78	17	80	18	73	24	110
Chloride, mg/l	3	3	5	8	3	3	4	2
Chromium, mg/l	-	0.010	0.010	0.023	<0.005	0.010	<0.005	0.006
Conductivity, 25°C, umhos/cm	140	320	140	420	150	420	190	460
Copper, mg/l	0.16	<0.01	0.08	0.06	<0.01	0.09	0.02	<0.01
Cyanide, mg/l	-	<0.01	-	<0.01	-	<0.01	-	-
Hardness, mg/l	69	210	60	210	61	190	78	280
Iron, mg/l	4.6	0.26	0.99	0.41	0.54	0.40	0.55	0.27
Lead, mg/l	0.04	<0.010	0.016	<0.010	0.020	0.022	<0.010	<0.010
Magnesium, mg/l	4.0	2.7	4.3	2.9	4.0	2.1	4.4	2.3
Manganese, mg/l	0.23	0.01	0.05	<0.01	0.07	0.01	0.08	0.03
Mercury, mg/l	<0.0002	0.014	<0.0002	<0.0002	0.0031	0.0026	0.0013	<0.002
Nickel, mg/l	<0.05	<0.05	<0.05	<0.05	<0.05	<0.05	<0.05	<0.05
Phosphorous, mg/l	0.12	0.05	0.08	0.05	0.03	-	0.07	0.09
Selenium, mg/l	0.004	0.018	<0.002	0.008	<0.002	0.006	<0.002	0.010
Silica, mg/l	5.0	4.2	5.4	5.1	-	-	4.6	3.9
Silver, mg/l	<0.01	<0.01	<0.01	<0.01	<0.01	<0.01	<0.01	<0.01
Solids, Dissolved, mg/l	100	270	90	290	90	310	110	320
Solids, Suspended, mg/l	67	13	20	20	5	14	6	8
Sulfate, mg/l	13	120	18	180	20	190	18	160
Zinc, mg/l	0.08	<0.01	0.11	0.06	0.03	0.03	0.10	0.07

A-36

Table A-10 (Continued)

TVA PLANT G RIVER WATER INTAKE AND COMBINED ASH POND DISCHARGE DATA  
(Quarterly Samples)

Date	1/13/75		4/9/75		7/14/75		10/8/75	
	River Intake	Pond Discharge	River Intake	Pond Discharge	River Intake	Pond Discharge	River Intake	Pond Discharge
Aluminum, mg/l	0.7	1.3	2.8	1.9	0.8	1.8	<0.2	1.3
Ammonia as N, mg/l	0.01	0.04	0.02	0.08	0.06	<0.01	0.06	0.62
Arsenic, mg/l	<0.005	0.025	<0.005	0.016	<0.005	0.040	0.005	0.075
Barium, mg/l	<0.1	0.2	0.1	0.2	<0.1	<0.1	<0.1	<0.1
Beryllium, mg/l	<0.01	<0.01	<0.01	<0.01	<0.01	<0.01	<0.01	<0.01
Cadmium, mg/l	<0.001	<0.001	0.001	0.001	<0.001	<0.001	<0.001	<0.001
Calcium, mg/l	25	47	13	38	19	48	24	75
Chloride, mg/l	4	3	3	3	3	4	3	4
Chromium, mg/l	<0.005	0.020	<0.005	0.009	<0.005	<0.005	<0.005	<0.005
Conductivity, 25°C, umhos/cm	190	330	120	320	150	290	150	380
Copper, mg/l	0.02	0.02	0.07	0.06	0.08	0.11	0.10	0.12
Cyanide, mg/l	-	<0.01	-	-	-	-	-	-
Hardness, mg/l	81	130	46	110	62	130	76	200
Iron, mg/l	0.91	0.61	2.3	0.72	0.33	1.4	0.45	0.52
Lead, mg/l	0.036	0.036	0.011	0.013	<0.010	<0.010	0.010	<0.010
Magnesium, mg/l	4.6	3.1	3.4	2.5	3.5	2.3	3.8	3.1
Manganese, mg/l	0.09	0.04	0.09	0.02	0.08	0.04	0.08	0.02
Mercury, mg/l	<0.0002	<0.0002	0.0320	0.0037	<0.0002	<0.0002	<0.0002	<0.0002
Nickel, mg/l	<0.05	0.05	<0.05	<0.05	<0.05	<0.05	<0.05	<0.05
Phosphorous, mg/l	0.07	0.10	0.09	0.07	0.08	0.14	0.16	0.09
Selenium, mg/l	<0.002	<0.002	<0.002	0.013	<0.002	0.006	<0.001	0.019
Silica, mg/l	4.8	3.4	3.5	4.9	4.0	7.1	3.5	4.3
Silver, mg/l	<0.01	<0.01	<0.01	<0.01	<0.01	<0.01	<0.01	<0.01
Solids, Dissolved, mg/l	110	220	70	200	480	190	100	290
Solids, Suspended, mg/l	19	18	14	45	6	24	5	27
Sulfate, mg/l	17	100	23	130	22	96	<1	620
Zinc, mg/l	0.05	0.08	0.13	0.10	0.11	0.10	0.08	0.05

A-37

Table A-10 (Continued)

TVA PLANT G RIVER WATER INTAKE AND COMBINED ASH POND DISCHARGE DATA  
(Quarterly Samples)

Date	1/7/76		4/12/76	
	River Intake	Pond Discharge	River Intake	Pond Discharge
Aluminum, mg/l	0.7	2.0	1.1	1.4
Ammonia as N, mg/l	0.02	0.12	0.02	0.02
Arsenic, mg/l	<0.005	0.070	<0.005	0.078
Barium, mg/l	<0.1	<0.1	<0.1	<0.1
Beryllium, mg/l	<0.01	<0.01	<0.01	<0.01
Cadmium, mg/l	<0.001	<0.001	<0.001	<0.001
Calcium, mg/l	28	100	24	42
Chloride, mg/l	5	4	4	4
Chromium, mg/l	<0.005	0.020	<0.005	<0.005
Conductivity, 25°C, umhos/cm	160	370	160	270
Copper, mg/l	0.02	0.01	0.01	0.02
Cyanide, mg/l	-	-	-	-
Hardness, mg/l	88	260	77	120
Iron, mg/l	0.78	0.08	1.5	0.56
Lead, mg/l	<0.010	<0.010	<0.010	<0.010
Magnesium, mg/l	4.5	3.4	4.2	2.6
Manganese, mg/l	0.07	0.03	0.10	0.02
Mercury, mg/l	<0.0002	<0.0002	<0.0002	0.0006
Nickel, mg/l	<0.05	<0.05	<0.05	<0.05
Phosphorous, mg/l	0.12	0.08	0.07	0.06
Selenium, mg/l	<0.002	0.016	<0.002	0.046
Silica, mg/l	4.5	4.2	4.8	5.6
Silver, mg/l	<0.01	<0.01	<0.01	<0.01
Solids, Dissolved, mg/l	110	270	90	160
Solids, Suspended, mg/l	9	41	13	17
Sulfate, mg/l	18	120	21	82
Zinc, mg/l	<0.01	0.01	<0.01	0.04



Table A-11

TVA PLANT H RIVER WATER INTAKE AND COMBINED ASH POND DISCHARGE DATA  
(Quarterly Samples)

Date	1/2/73		4/2/73		7/2/73		10/2/73	
	River Intake	Pond Discharge	River Intake	Pond Discharge	River Intake	Pond Discharge	River Intake	Pond Discharge
Aluminum, mg/l	NA	1.2	NA	2.9	NA	1.9	NA	2.5
Ammonia as N, mg/l	NA	0.48	NA	0.16	NA	0.03	NA	0.06
Arsenic, mg/l	NA	0.076	NA	0.070	NA	0.180	NA	0.140
Barium, mg/l	NA	0.1	NA	0.2	NA	0.1	NA	0.1
Beryllium, mg/l	NA	<0.01	NA	<0.01	NA	<0.01	NA	<0.01
Cadmium, mg/l	NA	<0.001	NA	<0.001	NA	<0.001	NA	<0.001
Calcium, mg/l	NA	39	NA	46	NA	49	NA	67
Chloride, mg/l	NA	12	NA	15	NA	20	NA	22
Chromium, mg/l	NA	<0.005	NA	<0.005	NA	<0.005	NA	0.008
Conductivity, 25°C, umhos/cm	NA	330	NA	350	NA	380	NA	460
Copper, mg/l	NA	<0.01	NA	0.05	NA	<0.01	NA	<0.01
Cyanide, mg/l	NA	<0.01	NA	<0.01	NA	<0.01	NA	<0.01
Hardness, mg/l	NA	130	NA	150	NA	150	NA	200
Iron, mg/l	NA	0.48	NA	1.4	NA	0.24	NA	0.51
Lead, mg/l	NA	<0.010	NA	<0.010	NA	<0.010	NA	<0.010
Magnesium, mg/l	NA	8.1	NA	7.8	NA	7.6	NA	8.8
Manganese, mg/l	NA	0.07	NA	0.07	NA	0.02	NA	0.03
Mercury, mg/l	NA	0.0007	NA	0.0016	NA	<0.0002	NA	<0.0002
Nickel, mg/l	NA	<0.05	NA	<0.05	NA	<0.05	NA	<0.05
Phosphorous, mg/l	NA	0.40	NA	0.21	NA	0.62	NA	0.63
Selenium, mg/l	NA	<0.004	NA	-	NA	0.014	NA	0.024
Silica, mg/l	NA	5.6	NA	5.2	NA	2.7	NA	3.6
Silver, mg/l	NA	<0.01	NA	<0.01	NA	<0.01	NA	<0.01
Solids, Dissolved, mg/l	NA	200	NA	240	NA	240	NA	300
Solids, Suspended, mg/l	NA	5	NA	19	NA	8	NA	7
Sulfate, mg/l	NA	85	NA	45	NA	65	NA	120
Zinc, mg/l	NA	0.01	NA	<0.01	NA	0.01	NA	0.02

NA = Not Available

Table A-11 (Continued)

TVA PLANT H RIVER WATER INTAKE AND COMBINED ASH POND DISCHARGE DATA  
(Quarterly Samples)

Date	1/14/74		4/9/74		7/15/74		12/4/74	
	River	Pond	River	Pond	River	Pond	River	Pond
	<u>Intake</u>	<u>Discharge</u>	<u>Intake</u>	<u>Discharge</u>	<u>Intake</u>	<u>Discharge</u>	<u>Intake</u>	<u>Discharge</u>
Aluminum, mg/l	1.2	1.4	1.1	1.1	0.6	1.2	<0.2	0.8
Ammonia as N, mg/l	0.11	0.16	0.24	0.03	0.06	0.04	0.15	2.6
Arsenic, mg/l	0.01	0.055	<0.005	0.035	<0.005	0.140	<0.005	0.065
Barium, mg/l	<0.1	<0.1	0.2	0.3	0.2	0.3	0.2	0.3
Beryllium, mg/l	<0.01	<0.01	<0.01	<0.01	<0.01	<0.01	<0.01	<0.01
Cadmium, mg/l	<0.001	<0.001	<0.001	<0.001	<0.001	<0.001	<0.001	0.001
Calcium, mg/l	29	42	26	42	23	60	22	34
Chloride, mg/l	7	8	9	10	9	10	10	16
Chromium, mg/l	<0.005	<0.005	<0.005	<0.005	<0.005	<0.005	0.007	0.010
Conductivity, 25°C, umhos/cm	220	350	230	350	220	440	240	400
Copper, mg/l	0.15	<0.01	0.05	0.10	0.03	0.04	0.11	0.14
Cyanide, mg/l	-	<0.01	-	<0.01	-	<0.01	-	-
Hardness, mg/l	100	130	88	130	82	180	82	120
Iron, mg/l	1.4	0.88	0.99	0.70	0.59	0.22	0.45	0.64
Lead, mg/l	0.040	0.030	<0.010	<0.010	0.016	0.010	<0.010	<0.010
Magnesium, mg/l	7.3	6.2	5.7	5.8	5.9	6.8	6.5	7.8
Manganese, mg/l	0.14	0.07	0.10	0.04	0.11	0.02	0.10	0.08
Mercury, mg/l	0.0008	0.0002	<0.0002	<0.0002	<0.0002	0.0012	0.0002	<0.0002
Nickel, mg/l	<0.05	<0.05	<0.05	<0.05	<0.05	<0.05	<0.05	0.07
Phosphorous, mg/l	0.06	0.06	0.06	0.04	0.06	0.13	0.06	0.14
Selenium, mg/l	0.006	0.014	<0.002	0.004	<0.002	<0.002	<0.002	0.028
Silica, mg/l	6.0	5.3	6.6	5.5	2.7	-	5.9	5.5
Silver, mg/l	<0.01	<0.01	<0.01	<0.01	<0.01	<0.01	<0.01	<0.01
Solids, Dissolved, mg/l	120	200	130	210	110	290	130	220
Solids, Suspended, mg/l	27	19	29	18	22	5	10	4
Sulfate, mg/l	18	100	17	80	16	140	20	70
Zinc, mg/l	0.08	0.01	0.06	0.07	0.05	0.05	0.10	0.15

Table A-11 (Continued)

TVA PLANT H RIVER WATER INTAKE AND COMBINED ASH POND DISCHARGE DATA  
(Quarterly Samples)

Date	1/14/75		4/8/75		7/9/75		10/14/75	
	River	Pond	River	Pond	River	Pond	River	Pond
	<u>Intake</u>	<u>Discharge</u>	<u>Intake</u>	<u>Discharge</u>	<u>Intake</u>	<u>Discharge</u>	<u>Intake</u>	<u>Discharge</u>
Aluminum, mg/l	0.8	1.2	1.6	1.7	1.3	1.6	0.9	1.3
Ammonia as N, mg/l	0.42	0.23	0.12	0.03	0.49	0.18	0.24	0.06
Arsenic, mg/l	<0.005	0.060	<0.005	0.240	<0.005	0.100	0.010	0.360
Barium, mg/l	<0.1	<0.1	<0.1	0.3	<0.1	<0.1	<0.1	<0.1
Beryllium, mg/l	<0.01	<0.01	<0.01	<0.01	<0.01	<0.01	<0.01	<0.01
Cadmium, mg/l	<0.001	0.001	0.001	0.002	<0.001	<0.001	<0.001	0.002
Calcium, mg/l	32	49	22	40	34	67	35	65
Chloride, mg/l	17	13	6	9	28	15	24	22
Chromium, mg/l	<0.005	<0.005	<0.005	0.008	<0.005	<0.005	<0.005	<0.005
Conductivity, 25°C, umhos/cm	280	400	240	420	310	490	330	510
Copper, mg/l	0.02	0.01	0.08	0.04	0.07	0.02	0.08	0.09
Cyanide, mg/l	-	<0.01	-	-	-	-	-	-
Hardness, mg/l	110	150	80	130	120	200	140	200
Iron, mg/l	1.5	0.65	1.7	0.44	0.83	0.33	0.92	0.18
Lead, mg/l	0.020	0.036	0.033	0.021	<0.010	<0.010	0.012	<0.010
Magnesium, mg/l	6.4	7.0	6.2	6.6	8.1	6.8	13	9.7
Manganese, mg/l	0.17	0.10	0.12	0.06	0.17	0.07	0.18	0.03
Mercury, mg/l	<0.0002	<0.0002	<0.0002	<0.0002	0.0002	<0.0002	<0.0002	<0.0002
Nickel, mg/l	<0.05	<0.05	<0.05	<0.05	<0.05	<0.05	<0.05	<0.05
Phosphorous, mg/l	0.45	0.09	0.08	0.06	0.18	0.12	0.14	0.16
Selenium, mg/l	<0.002	0.020	<0.002	0.034	<0.002	0.020	<0.001	0.023
Silica, mg/l	5.8	5.5	4.6	5.3	4.4	4.6	3.3	4.6
Silver, mg/l	<0.01	<0.01	<0.01	<0.01	<0.01	<0.01	<0.01	<0.01
Solids, Dissolved, mg/l	170	230	140	270	180	320	180	350
Solids, Suspended, mg/l	29	15	26	6	24	5	22	7
Sulfate, mg/l	19	90	18	150	21	130	22	100
Zinc, mg/l	0.11	0.04	0.07	0.06	0.04	0.04	0.33	0.08

A-41

Table A-12

TVA PLANT H RIVER WATER INTAKE AND FLY ASH POND DISCHARGE DATA  
(Quarterly Samples)

Date	1/14/76		4/12/76	
	River Intake	Pond Discharge	River Intake	Pond Discharge
Aluminum, mg/l	NA	2.2	NA	2.2
Ammonia as N, mg/l	NA	0.19	NA	0.15
Arsenic, mg/l	NA	0.085	NA	0.220
Barium, mg/l	NA	<0.1	NA	<0.1
Beryllium, mg/l	NA	<0.01	NA	<0.01
Cadmium, mg/l	NA	0.007	NA	0.010
Calcium, mg/l	NA	69	NA	91
Chloride, mg/l	NA	11	NA	20
Chromium, mg/l	NA	0.011	NA	0.011
Conductivity, 25°C, umhos/cm	NA	440	NA	630
Copper, mg/l	NA	0.02	NA	0.16
Cyanide, mg/l	NA	-	NA	-
Hardness, mg/l	NA	200	NA	280
Iron, mg/l	NA	0.80	NA	2.3
Lead, mg/l	NA	<0.010	NA	<0.010
Magnesium, mg/l	NA	7.4	NA	12
Manganese, mg/l	NA	0.08	NA	0.19
Mercury, mg/l	NA	<0.0002	NA	0.0002
Nickel, mg/l	NA	<0.05	NA	<0.05
Phosphorous, mg/l	NA	0.09	NA	0.09
Selenium, mg/l	NA	0.019	NA	-
Silica, mg/l	NA	5.9	NA	4.9
Silver, mg/l	NA	<0.01	NA	<0.01
Solids, Dissolved, mg/l	NA	290	NA	450
Solids, Suspended, mg/l	NA	35	NA	11
Sulfate, mg/l	NA	140	NA	220
Zinc, mg/l	NA	0.10	NA	0.11

Table A-13

TVA PLANT H RIVER WATER INTAKE AND BOTTOM ASH POND DISCHARGE DATA  
(Quarterly Samples)

Date	1/14/76		4/12/76	
	River Intake	Pond Discharge	River Intake	Pond Discharge
Aluminum, mg/l	*	1.7	0.5	0.9
Ammonia as N, mg/l	0.27	0.15	0.55	0.18
Arsenic, mg/l	<0.005	0.060	<0.010	NES
Barium, mg/l	*	<0.1	<0.1	0.4
Beryllium, mg/l	*	<0.01	<0.01	<0.01
Cadmium, mg/l	*	0.001	<0.001	<0.001
Calcium, mg/l	*	49	43	55
Chloride, mg/l	11	11	27	21
Chromium, mg/l	*	<0.005	<0.005	<0.005
Conductivity, 25°C, umhos/cm	260	340	390	420
Copper, mg/l	*	<0.01	0.03	<0.01
Cyanide, mg/l	-	-	-	-
Hardness, mg/l	*	150	150	180
Iron, mg/l	*	1.2	0.53	0.72
Lead, mg/l	*	<0.010	0.013	<0.010
Magnesium, mg/l	*	6.1	9.3	11
Manganese, mg/l	*	0.04	0.14	0.06
Mercury, mg/l	*	<0.0002	<0.0002	<0.0002
Nickel, mg/l	*	<0.05	<0.05	<0.05
Phosphorous, mg/l	0.09	0.12	0.24	0.10
Selenium, mg/l	<0.002	0.010	<0.002	*
Silica, mg/l	6.5	5.5	2.3	3.8
Silver, mg/l	*	<0.01	<0.01	<0.01
Solids, Dissolved, mg/l	150	210	200	260
Solids, Suspended, mg/l	23	35	4	2
Sulfate, mg/l	20	59	42	100
Zinc, mg/l	*	<0.01	0.02	<0.01

\*Bottle Received Broken.

Table A-14

TVA PLANT I RIVER WATER INTAKE AND COMBINED ASH POND (SOUTH) DISCHARGE  
(Quarterly Samples)

Date	1/3/73		5/16/73		7/9/73		10/1/73	
	River Intake	Pond Discharge	River Intake	Pond Discharge	River Intake	Pond Discharge	River Intake	Pond Discharge
Aluminum, mg/l	NA	0.6	NA	1.2	NA	1.6	NA	1.1
Ammonia as N, mg/l	NA	0.31	NA	0.05	NA	0.05	NA	0.03
Arsenic, mg/l	NA	<0.005	NA	-	NA	0.005	NA	0.005
Barium, mg/l	NA	0.1	NA	0.2	NA	0.1	NA	0.2
Beryllium, mg/l	NA	<0.01	NA	<0.01	NA	<0.01	NA	<0.01
Cadmium, mg/l	NA	<0.001	NA	<0.001	NA	-	NA	<0.001
Calcium, mg/l	NA	110	NA	99	NA	140	NA	100
Chloride, mg/l	NA	11	NA	6	NA	6	NA	7
Chromium, mg/l	NA	0.016	NA	0.006	NA	0.021	NA	0.026
Conductivity, 25°C, umhos/cm	NA	610	NA	540	NA	750	NA	680
Copper, mg/l	NA	<0.01	NA	0.02	NA	0.02	NA	<0.01
Cyanide, mg/l	NA	<0.01	NA	<0.01	NA	<0.01	NA	<0.01
Hardness, mg/l	NA	280	NA	250	NA	350	NA	250
Iron, mg/l	NA	0.05	NA	0.09	NA	0.09	NA	<0.05
Lead, mg/l	NA	<0.010	NA	<0.010	NA	-	NA	0.010
Magnesium, mg/l	NA	0.4	NA	0.2	NA	0.4	NA	0.2
Manganese, mg/l	NA	<0.01	NA	0.01	NA	<0.01	NA	<0.01
Mercury, mg/l	NA	0.0012	NA	<0.0002	NA	<0.0002	NA	<0.0002
Nickel, mg/l	NA	<0.05	NA	<0.05	NA	<0.05	NA	0.05
Phosphorous, mg/l	NA	0.05	NA	0.03	NA	0.06	NA	<0.03
Selenium, mg/l	NA	<0.004	NA	0.004	NA	0.004	NA	0.006
Silica, mg/l	NA	7.1	NA	7.4	NA	7.0	NA	7.6
Silver, mg/l	NA	<0.01	NA	<0.01	NA	<0.01	NA	<0.01
Solids, Dissolved, mg/l	NA	280	NA	230	NA	300	NA	300
Solids, Suspended, mg/l	NA	3	NA	2	NA	6	NA	3
Sulfate, mg/l	NA	60	NA	50	NA	75	NA	64
Zinc, mg/l	NA	<0.01	NA	0.24	NA	0.01	NA	0.03

NA = Not Available

Table A-14 (Continued)

TVA PLANT I RIVER WATER INTAKE AND COMBINED ASH POND (SOUTH) DISCHARGE  
(Quarterly Samples)

Date	2/19/74		4/8/74		7/15/74		10/15/74	
	River	Pond	River	Pond	River	Pond	River	Pond
	Intake	Discharge	Intake	Discharge	Intake	Discharge	Intake	Discharge
Aluminum, mg/l	1.4	0.8	2.0	1.1	0.8	2.0	1.2	2.6
Ammonia as N, mg/l	0.05	0.03	0.08	0.06	0.02	0.03	0.04	0.03
Arsenic, mg/l	<0.005	<0.005	<0.005	<0.005	<0.005	<0.005	<0.005	<0.005
Barium, mg/l	0.2	0.3	0.3	0.2	0.1	0.2	<0.1	0.5
Beryllium, mg/l	<0.01	<0.01	<0.01	<0.01	<0.01	<0.01	<0.01	<0.01
Cadmium, mg/l	<0.001	<0.001	<0.001	<0.001	<0.001	0.002	0.001	<0.001
Calcium, mg/l	21	74	20	46	18	92	21	140
Chloride, mg/l	4	4	4	4	6	5	8	10
Chromium, mg/l	<0.005	0.030	<0.005	4	<0.005	0.020	<0.005	0.026
Conductivity, 25°C, umhos/cm	170	540	150	440	150	750	180	940
Copper, mg/l	0.11	0.13	0.10	0.05	0.07	0.15	0.12	0.10
Cyanide, mg/l	-	<0.01	-	<0.01	-	<0.01	-	-
Hardness, mg/l	66	190	64	120	59	230	70	350
Iron, mg/l	1.7	0.15	1.8	0.28	0.80	0.25	0.61	0.17
Lead, mg/l	0.021	<0.010	0.014	<0.010	0.017	0.038	0.016	0.010
Magnesium, mg/l	3.3	0.4	3.3	0.5	3.5	0.3	4.3	0.2
Manganese, mg/l	0.11	<0.01	0.12	0.5	0.06	<0.01	0.01	0.01
Mercury, mg/l	<0.0002	<0.0002	<0.0002	<0.0002	<0.0002	<0.0002	<0.0002	<0.0002
Nickel, mg/l	<0.05	<0.005	<0.05	<0.05	<0.05	<0.05	<0.05	<0.05
Phosphorous, mg/l	0.15	0.01	0.21	0.04	0.04	<0.01	0.10	<0.01
Selenium, mg/l	0.002	0.08	<0.002	0.007	<0.002	<0.002	<0.002	0.012
Silica, mg/l	5.6	7.9	5.9	7.8	3.2	-	-	9.1
Silver, mg/l	<0.01	<0.01	<0.01	<0.01	<0.01	<0.01	<0.01	<0.01
Solids, Dissolved, mg/l	100	220	90	190	90	230	100	370
Solids, Suspended, mg/l	18	4	28	2	16	<1	3	2
Sulfate, mg/l	12	61	14	58	10	90	12	100
Zinc, mg/l	0.08	0.07	0.12	0.08	0.09	0.09	0.05	0.08

A-45

Table A-14 (Continued)

TVA PLANT I RIVER WATER INTAKE AND COMBINED ASH POND (SOUTH) DISCHARGE  
(Quarterly Samples)

Date	1/13/75		4/7/75		7/14/75		10/20/75	
	River	Pond	River	Pond	River	Pond	River	Pond
	Intake	Discharge	Intake	Discharge	Intake	Discharge	Intake	Discharge
Aluminum, mg/l	3.0	1.4	2.0	1.9	*	2.1	1.0	1.2
Ammonia as N, mg/l	0.10	0.06	0.04	0.10	0.03	0.01	0.07	0.07
Arsenic, mg/l	<0.005	0.010	<0.005	0.100	*	0.110	<0.005	0.160
Barium, mg/l	<0.1	<0.1	0.3	<0.1	*	<0.1	<0.1	<0.1
Beryllium, mg/l	<0.01	<0.01	<0.01	<0.01	*	<0.01	<0.01	<0.01
Cadmium, mg/l	<0.001	<0.001	0.001	0.001	*	<0.001	<0.001	<0.001
Calcium, mg/l	18	44	17	45	*	58	19	61
Chloride, mg/l	5	6	6	4	5	4	6	7
Chromium, mg/l	<0.005	0.024	0.005	0.007	*	<0.005	<0.005	<0.005
Conductivity, 25°C, umhos/cm	130	310	140	310	150	330	150	350
Copper, mg/l	0.01	0.02	0.06	0.02	*	0.09	0.04	0.04
Cyanide, mg/l	-	<0.01	-	-	-	-	-	-
Hardness, mg/l	56	120	53	120	*	160	61	180
Iron, mg/l	3.9	0.35	1.8	0.58	*	0.47	1.5	0.57
Lead, mg/l	0.014	0.012	0.012	0.019	*	<0.010	<0.010	<0.010
Magnesium, mg/l	2.7	2.0	2.6	2.2	*	3.7	3.4	3.5
Manganese, mg/l	0.20	0.02	0.12	0.01	*	0.02	0.11	<0.01
Mercury, mg/l	<0.0002	<0.0002	<0.0002	0.0005	<0.0002	<0.0002	0.0003	<0.0002
Nickel, mg/l	<0.05	<0.05	<0.05	<0.05	*	<0.05	<0.05	<0.05
Phosphorous, mg/l	0.36	0.05	0.15	0.09	0.10	0.25	0.26	0.24
Selenium, mg/l	<0.002	<0.002	<0.002	0.007	<0.002	0.008	<0.001	0.005
Silica, mg/l	6.4	6.3	6.5	6.0	4.4	6.0	5.9	6.2
Silver, mg/l	<0.01	<0.01	<0.01	<0.01	*	<0.01	<0.01	<0.01
Solids, Dissolved, mg/l	100	190	100	210	90	220	90	230
Solids, Suspended, mg/l	57	15	16	7	20	4	31	15
Sulfate, mg/l	10	50	20	70	11	200	12	88
Zinc, mg/l	0.05	0.04	0.11	0.06	*	0.11	0.03	0.10

\*Bottle Broken



Table A-14 (Continued)

TVA PLANT I RIVER WATER INTAKE AND COMBINED ASH POND (SOUTH) DISCHARGE  
(Quarterly Samples)

Date	1/12/76		4/12/76	
	River Intake	Pond Discharge	River Intake	Pond Discharge
Aluminum, mg/l	1.1	3.4	1.0	0.4
Ammonia as N, mg/l	0.07	0.20	0.05	0.07
Arsenic, mg/l	<0.005	0.035	<0.005	0.010
Barium, mg/l	<0.1	<0.1	<0.1	<0.1
Beryllium, mg/l	<0.01	<0.01	<0.01	<0.01
Cadmium, mg/l	<0.001	<0.001	<0.001	<0.010
Calcium, mg/l	27	59	26	140
Chloride, mg/l	7	6	5	6
Chromium, mg/l	<0.005	0.012	<0.005	0.006
Conductivity, 25°C, umhos/cm	150	310	170	880
Copper, mg/l	<0.01	<0.01	0.03	<0.01
Cyanide, mg/l	-	-	-	-
Hardness, mg/l	81	160	79	350
Iron, mg/l	1.0	1.0	1.2	0.07
Lead, mg/l	<0.010	<0.010	<0.010	<0.010
Magnesium, mg/l	3.2	3.6	3.4	0.5
Manganese, mg/l	0.07	0.01	0.09	0.01
Mercury, mg/l	<0.0002	<0.0002	<0.0002	<0.0002
Nickel, mg/l	<0.05	<0.05	<0.05	<0.05
Phosphorous, mg/l	0.11	0.24	0.11	0.03
Selenium, mg/l	<0.002	0.015	<0.002	0.020
Silica, mg/l	6.3	6.1	5.0	8.1
Silver, mg/l	<0.01	<0.01	<0.01	<0.01
Solids, Dissolved, mg/l	110	200	90	360
Solids, Suspended, mg/l	9	48	10	15
Sulfate, mg/l	12	59	12	120
Zinc, mg/l	0.02	<0.01	0.02	0.06

Table A-15

TVA PLANT J RIVER WATER INTAKE AND COMBINED ASH POND DISCHARGE  
(Quarterly Samples)

Date	1/3/73		4/3/73		7/2/73		10/1/73	
	River Intake	Pond Discharge	River Intake	Pond Discharge	River Intake	Pond Discharge	River Intake	Pond Discharge
Aluminum, mg/l	NA	3.6	NA	5.0	NA	0.4	NA	1.3
Ammonia as N, mg/l	NA	0.08	NA	0.04	NA	0.06	NA	0.04
Arsenic, mg/l	NA	0.018	NA	0.014	NA	0.015	NA	0.080
Barium, mg/l	NA	0.1	NA	<0.1	NA	<0.1	NA	<0.1
Beryllium, mg/l	NA	<0.01	NA	<0.01	NA	<0.01	NA	<0.01
Cadmium, mg/l	NA	0.002	NA	0.001	NA	<0.001	NA	<0.001
Calcium, mg/l	NA	30	NA	31	NA	39	NA	57
Chloride, mg/l	NA	3	NA	3	NA	4	NA	4
Chromium, mg/l	NA	0.006	NA	<0.005	NA	<0.005	NA	0.005
Conductivity, 25°C, umhos/cm	NA	360	NA	340	NA	320	NA	380
Copper, mg/l	NA	0.05	NA	0.03	NA	0.02	NA	0.02
Cyanide, mg/l	NA	<0.01	NA	<0.01	NA	<0.01	NA	<0.01
Hardness, mg/l	NA	96	NA	100	NA	130	NA	180
Iron, mg/l	NA	2.7	NA	3.4	NA	0.66	NA	0.58
Lead, mg/l	NA	<0.010	NA	<0.010	NA	<0.010	NA	<0.010
Magnesium, mg/l	NA	5.0	NA	6.0	NA	8.2	NA	9.3
Manganese, mg/l	NA	0.66	NA	0.62	NA	0.44	NA	0.16
Mercury, mg/l	NA	0.0008	NA	<0.0002	NA	<0.0002	NA	<0.0002
Nickel, mg/l	NA	<0.05	NA	<0.05	NA	<0.5	NA	<0.05
Phosphorous, mg/l	NA	0.15	NA	0.03	NA	0.04	NA	0.39
Selenium, mg/l	NA	<0.004	NA	0.003	NA	0.002	NA	<0.001
Silica, mg/l	NA	7.5	NA	7.9	NA	5.7	NA	5.6
Silver, mg/l	NA	<0.01	NA	<0.01	NA	<0.01	NA	<0.01
Solids, Dissolved, mg/l	NA	210	NA	220	NA	200	NA	250
Solids, Suspended, mg/l	NA	2	NA	35	NA	2	NA	5
Sulfate, mg/l	NA	140	NA	120	NA	120	NA	120
Zinc, mg/l	NA	0.04	NA	0.06	NA	0.04	NA	0.02

NA = Not Available

Table A-15 (Continued)

TVA PLANT J RIVER WATER INTAKE AND COMBINED ASH POND DISCHARGE  
(Quarterly Samples)

Date	1/14/74		4/4/74		7/15/74		10/8/74	
	River Intake	Pond Discharge	River Intake	Pond Discharge	River Intake	Pond Discharge	River Intake	Pond Discharge
Aluminum, mg/l	0.9	7.6	1.4	2.1	0.4	1.0	0.3	0.4
Ammonia as N, mg/l	<0.01	0.05	0.02	<0.08	0.01	<0.01	0.01	0.01
Arsenic, mg/l	<0.005	0.025	<0.005	<0.005	0.110	0.110	<0.005	0.040
Barium, mg/l	<0.1	<0.1	0.4	0.3	0.2	0.2	0.2	0.2
Beryllium, mg/l	<0.01	<0.01	<0.01	<0.01	<0.01	<0.01	<0.01	<0.01
Cadmium, mg/l	<0.001	<0.001	<0.001	<0.001	<0.001	<0.002	<0.001	<0.001
Calcium, mg/l	5	32	4	23	26	38	30	47
Chloride, mg/l	2	2	2	3	3	2	4	3
Chromium, mg/l	<0.005	0.007	<0.005	<0.005	<0.005	<0.005	0.006	0.006
Conductivity, 25°C, umhos/cm	44	370	51	250	320	320	240	350
Copper, mg/l	0.13	0.08	0.12	0.18	0.04	0.05	0.04	0.04
Cyanide, mg/l	-	<0.01	-	<0.01	-	<0.01	-	-
Hardness, mg/l	19	100	16	73	95	130	110	150
Iron, mg/l	0.91	9.4	1.5	1.2	0.44	0.39	0.26	0.10
Lead, mg/l	<0.01	0.028	0.020	<0.010	<0.010	0.038	<0.010	<0.010
Magnesium, mg/l	1.6	5.7	1.5	3.9	7.3	8.2	8.3	8.6
Manganese, mg/l	0.08	0.68	0.07	0.40	0.03	0.05	0.03	0.08
Mercury, mg/l	<0.0002	<0.0002	<0.0002	<0.0002	<0.0002	0.0005	<0.0002	<0.0002
Nickel, mg/l	<0.05	<0.07	<0.05	<0.05	<0.05	<0.05	<0.05	<0.05
Phosphorous, mg/l	<0.01	0.03	0.03	0.04	0.02	0.11	0.02	0.03
Selenium, mg/l	<0.002	0.006	<0.002	<0.002	0.008	0.004	<0.002	<0.002
Silica, mg/l	4.1	6.8	4.5	6.5	1.0	-	4.0	3.5
Silver, mg/l	<0.01	<0.01	<0.01	<0.01	<0.01	<0.01	<0.01	<0.01
Solids, Dissolved, mg/l	40	250	40	140	210	200	130	220
Solids, Suspended, mg/l	10	81	35	12	7	9	5	1
Sulfate, mg/l	13	170	13	120	80	90	14	94
Zinc, mg/l	0.08	0.09	0.09	0.12	0.08	0.03	0.05	0.03

A-49

Table A-15 (Continued)

TVA PLANT J RIVER WATER INTAKE AND COMBINED ASH POND DISCHARGE  
(Quarterly Samples)

Date	1/15/75		4/8/75		7/14/75		10/15/75	
	River Intake	Pond Discharge	River Intake	Pond Discharge	River Intake	Pond Discharge	River Intake	Pond Discharge
Aluminum, mg/l	0.6	4.4	1.0	3.0	1.0	1.5	0.3	1.4
Ammonia as N, mg/l	0.02	0.04	0.23	3.7	0.02	0.07	0.03	0.03
Arsenic, mg/l	<0.005	0.005	<0.005	<0.005	0.007	0.130	<0.005	0.040
Barium, mg/l	<0.1	0.2	<0.1	0.3	<0.1	<0.1	<0.1	<0.1
Beryllium, mg/l	<0.01	<0.01	<0.01	<0.01	<0.01	<0.01	<0.01	<0.01
Cadmium, mg/l	<0.001	<0.001	<0.002	<0.002	<0.001	<0.001	<0.001	<0.001
Calcium, mg/l	4.0	29	8.0	20	24	40	20	25
Chloride, mg/l	2	2	4	21	3	6	3	3
Chromium, mg/l	<0.005	<0.005	<0.005	0.006	<0.005	<0.005	<0.005	<0.005
Conductivity, 25°C, umhos/cm	44	390	90	420	200	310	160	230
Copper, mg/l	<0.01	0.04	0.06	0.73	0.11	0.05	0.09	0.05
Cyanide, mg/l	-	<0.01	-	-	-	-	-	-
Hardness, mg/l	15	94	30	67	89	140	76	85
Iron, mg/l	0.50	5.2	0.61	3.8	1.1	0.86	0.28	0.52
Lead, mg/l	0.18	0.014	0.011	0.018	<0.010	<0.010	0.010	<0.010
Magnesium, mg/l	1.2	5.3	2.4	4.1	7.1	9.9	6.4	5.6
Manganese, mg/l	0.06	0.79	0.18	0.40	0.05	0.14	0.06	0.13
Mercury, mg/l	<0.0002	<0.0002	<0.0002	0.0004	<0.0002	<0.0002	0.0009	<0.0002
Nickel, mg/l	<0.05	<0.05	<0.05	0.08	<0.05	0.05	<0.05	<0.05
Phosphorous, mg/l	0.01	<0.01	0.01	0.08	0.02	0.11	0.03	0.07
Selenium, mg/l	<0.002	<0.002	<0.002	<0.002	<0.002	0.008	<0.001	0.007
Silica, mg/l	3.9	6.6	4.8	8.7	5.0	7.1	3.8	4.7
Silver, mg/l	<0.01	<0.01	<0.01	<0.01	<0.01	<0.01	<0.01	<0.01
Solids, Dissolved, mg/l	30	210	50	170	110	200	100	150
Solids, Suspended, mg/l	5	9	25	9	7	4	7	6
Sulfate, mg/l	9	180	14	140	16	72	13	56
Zinc, mg/l	0.04	0.11	0.04	0.25	0.03	0.02	0.04	0.08

A-50

Table A-15 (Continued)

TVA PLANT J RIVER WATER INTAKE AND COMBINED ASH POND DISCHARGE  
(Quarterly Samples)

Date	1/7/76		4/13/76	
	River Intake	Pond Discharge	River Intake	Pond Discharge
Aluminum, mg/l	0.4	1.5	0.6	1.3
Ammonia as N, mg/l	0.01	0.04	0.01	0.07
Arsenic, mg/l	<0.005	0.090	<0.010	0.100
Barium, mg/l	<0.1	0.1	<0.1	<0.1
Beryllium, mg/l	<0.01	<0.01	<0.01	<0.01
Cadmium, mg/l	<0.001	0.002	<0.001	0.0001
Calcium, mg/l	6.0	23	9.0	22
Chloride, mg/l	3	3	3	3
Chromium, mg/l	0.014	<0.005	<0.005	<0.005
Conductivity, 25°C, umhos/cm	48	230	74	NES
Copper, mg/l	0.01	0.03	0.05	0.09
Cyanide, mg/l	-	-	-	-
Hardness, mg/l	20	70	32	68
Iron, mg/l	0.45	3.2	0.84	1.5
Lead, mg/l	<0.010	<0.010	<0.010	<0.010
Magnesium, mg/l	1.3	3.0	2.2	3.2
Manganese, mg/l	0.07	0.28	0.11	0.32
Mercury, mg/l	<0.0002	<0.0002	<0.0002	0.0006
Nickel, mg/l	<0.05	<0.05	<0.05	<0.05
Phosphorous, mg/l	0.01	0.09	0.02	0.03
Selenium, mg/l	<0.002	0.004	<0.002	0.004
Silica, mg/l	4.1	5.6	4.6	6.2
Silver, mg/l	<0.01	<0.01	<0.01	<0.01
Solids, Dissolved, mg/l	40	70	50	140
Solids, Suspended, mg/l	4	14	6	4
Sulfate, mg/l	10	85	18	92
Zinc, mg/l	<0.01	0.04	<0.01	0.06

Table A-16

TVA PLANT K RIVER WATER INTAKE AND COMBINED ASH POND DISCHARGE  
(Quarterly Samples)

Date	1/2/73		4/2/73		7/2/73		10/1/73	
	River Intake	Pond Discharge	River Intake	Pond Discharge	River Intake	Pond Discharge	River Intake	Pond Discharge
Aluminum, mg/l	NA	1.3	NA	1.9	NA	2.3	NA	0.5
Ammonia as N, mg/l	NA	0.05	NA	0.03	NA	0.16	NA	0.02
Arsenic, mg/l	NA	0.008	NA	<0.005	NA	-	NA	0.025
Barium, mg/l	NA	<0.1	NA	<0.1	NA	0.2	NA	<0.1
Beryllium, mg/l	NA	<0.01	NA	<0.01	NA	<0.01	NA	<0.01
Cadmium, mg/l	NA	<0.001	NA	<0.001	NA	<0.001	NA	<0.001
Calcium, mg/l	NA	87	NA	110	NA	130	NA	75
Chloride, mg/l	NA	13	NA	9	NA	13	NA	19
Chromium, mg/l	NA	0.022	NA	0.015	NA	0.023	NA	0.023
Conductivity, 25°C, umhos/cm	NA	380	NA	520	NA	580	NA	480
Copper, mg/l	NA	<0.01	NA	<0.01	NA	<0.01	NA	0.03
Cyanide, mg/l	NA	<0.01	NA	<0.01	NA	<0.01	NA	<0.01
Hardness, mg/l	NA	220	NA	280	NA	330	NA	190
Iron, mg/l	NA	0.11	NA	0.34	NA	0.17	NA	0.13
Lead, mg/l	NA	<0.010	NA	<0.010	NA	<0.010	NA	<0.010
Magnesium, mg/l	NA	1.0	NA	0.4	NA	0.7	NA	1.1
Manganese, mg/l	NA	<0.01	NA	0.02	NA	<0.01	NA	<0.01
Mercury, mg/l	NA	0.0008	NA	0.0003	NA	0.0008	NA	<0.0002
Nickel, mg/l	NA	<0.05	NA	<0.05	NA	<0.05	NA	0.22
Phosphorous, mg/l	NA	0.03	NA	<0.03	NA	0.06	NA	0.10
Selenium, mg/l	NA	0.016	NA	0.008	NA	0.008	NA	0.012
Silica, mg/l	NA	7.0	NA	7.4	NA	8.8	NA	7.1
Silver, mg/l	NA	<0.01	NA	<0.01	NA	<0.01	NA	<0.01
Solids, Dissolved, mg/l	NA	220	NA	240	NA	290	NA	310
Solids, Suspended, mg/l	NA	7	NA	5	NA	3	NA	6
Sulfate, mg/l	NA	72	NA	55	NA	90	NA	88
Zinc, mg/l	NA	0.11	NA	<0.01	NA	0.02	NA	0.02

NA = Not Available

Table A-16 (Continued)

TVA PLANT K RIVER WATER INTAKE AND COMBINED ASH POND DISCHARGE  
(Quarterly Samples)

Date	1/14/74		4/8/74		7/15/74		10/8/74	
	River Intake	Pond Discharge	River Intake	Pond Discharge	River Intake	Pond Discharge	River Intake	Pond Discharge
Aluminum, mg/l	2.8	1.8	2.3	1.8	3.4	2.4	1.4	1.3
Ammonia as N, mg/l	0.08	0.06	0.04	0.03	0.06	0.04	0.24	0.07
Arsenic, mg/l	0.015	0.010	<0.005	0.005	<0.005	<0.005	<0.005	0.025
Barium, mg/l	<0.1	<0.1	0.3	0.3	0.2	0.2	0.1	0.3
Beryllium, mg/l	<0.01	<0.01	<0.01	<0.01	<0.01	<0.01	<0.01	<0.01
Cadmium, mg/l	<0.001	0.001	<0.001	<0.001	0.001	0.002	<0.001	<0.001
Calcium, mg/l	15	77	16	52	18	76	28	92
Chloride, mg/l	6	11	6	9	6	7	10	12
Chromium, mg/l	0.027	0.014	0.012	0.019	<0.005	0.026	0.006	0.026
Conductivity, 25°C, umhos/cm	140	500	160	460	150	640	260	400
Copper, mg/l	0.12	0.07	0.12	0.08	<0.01	0.10	0.04	0.05
Cyanide, mg/l	-	<0.01	-	<0.01	-	<0.01	-	-
Hardness, mg/l	52	190	56	130	61	190	98	240
Iron, mg/l	2.6	0.32	2.2	0.33	3.3	0.33	1.3	0.18
Lead, mg/l	0.022	0.017	<0.010	<0.010	0.030	0.040	<0.010	0.014
Magnesium, mg/l	3.6	0.6	3.8	0.6	3.8	0.5	6.9	3.0
Manganese, mg/l	0.09	<0.01	0.11	<0.01	0.18	<0.01	0.07	<0.01
Mercury, mg/l	<0.0002	<0.0002	<0.0002	0.0003	<0.0002	<0.0002	<0.0002	<0.0002
Nickel, mg/l	<0.05	<0.05	<0.05	<0.05	<0.05	<0.05	<0.05	<0.05
Phosphorous, mg/l	0.13	0.01	0.10	0.01	0.06	<0.01	0.08	0.06
Selenium, mg/l	<0.002	0.014	<0.002	0.012	<0.002	<0.002	<0.002	0.012
Silica, mg/l	5.3	6.5	4.8	8.0	2.5	-	5.9	6.7
Silver, mg/l	<0.01	<0.01	<0.01	<0.01	<0.01	<0.01	<0.01	<0.01
Solids, Dissolved, mg/l	90	240	100	220	80	250	150	240
Solids, Suspended, mg/l	31	10	26	8	60	3	30	5
Sulfate, mg/l	22	89	18	100	13	90	31	110
Zinc, mg/l	0.09	0.08	0.08	0.06	0.04	0.04	0.06	0.05

A-53

Table A-16 (Continued)

TVA PLANT K RIVER WATER INTAKE AND COMBINED ASH POND DISCHARGE  
(Quarterly Samples)

Date	1/13/75		4/7/75		7/14/75		10/14/75	
	River	Pond	River	Pond	River	Pond	River	Pond
	Intake	Discharge	Intake	Discharge	Intake	Discharge	Intake	Discharge
Aluminum, mg/l	1.8	3.1	2.6	1.7	1.1	2.2	0.6	1.4
Ammonia as N, mg/l	0.05	0.08	0.13	0.10	0.06	0.04	0.05	0.02
Arsenic, mg/l	<0.005	0.045	<0.005	0.050	0.024	0.100	<0.005	0.085
Barium, mg/l	<0.1	0.3	<0.1	<0.1	<0.1	<0.1	<0.1	<0.1
Beryllium, mg/l	<0.01	<0.01	<0.01	<0.01	<0.01	<0.01	<0.01	<0.01
Cadmium, mg/l	<0.001	<0.001	<0.001	0.001	<0.001	<0.001	<0.001	0.001
Calcium, mg/l	21	60	12	47	25	64	22	44
Chloride, mg/l	6	8	4	7	8	6	8	9
Chromium, mg/l	<0.005	0.036	0.009	0.009	<0.005	0.015	<0.005	<0.005
Conductivity, 25°C, umhos/cm	160	350	120	320	200	340	150	300
Copper, mg/l	0.02	0.02	0.08	0.03	0.11	0.01	0.09	0.09
Cyanide, mg/l	-	<0.01	-	-	-	-	-	-
Hardness, mg/l	66	160	40	130	87	180	73	120
Iron, mg/l	1.8	1.0	2.2	0.37	1.4	1.2	0.66	0.18
Lead, mg/l	0.020	0.048	0.010	0.012	<0.010	<0.010	<0.010	0.010
Magnesium, mg/l	3.4	2.4	2.5	2.4	6.0	3.6	4.4	3.0
Manganese, mg/l	0.10	0.03	0.07	0.01	0.10	0.04	0.08	0.01
Mercury, mg/l	<0.0002	<0.0002	<0.0002	<0.0002	<0.0002	<0.0002	<0.0002	<0.0002
Nickel, mg/l	<0.05	<0.05	<0.05	<0.05	<0.05	<0.05	<0.05	<0.05
Phosphorous, mg/l	0.11	0.06	0.11	0.08	0.09	0.17	0.09	0.12
Selenium, mg/l	<0.002	<0.002	<0.002	0.011	<0.002	0.009	<0.001	0.008
Silica, mg/l	5.6	6.6	5.0	4.0	2.5	5.3	5.4	5.8
Silver, mg/l	<0.01	<0.01	<0.01	<0.01	<0.01	<0.01	<0.01	<0.01
Solids, Dissolved, mg/l	100	210	110	240	120	240	100	180
Solids, Suspended, mg/l	20	26	21	7	23	6	17	11
Sulfate, mg/l	12	60	19	88	23	100	21	54
Zinc, mg/l	0.04	0.04	0.06	0.02	0.11	0.07	0.06	0.04

A-54



Table A-16 (Continued)

TVA PLANT K RIVER WATER INTAKE AND COMBINED ASH POND DISCHARGE  
(Quarterly Samples)

Date	1/12/76		4/12/76	
	River Intake	Pond Discharge	River Intake	Pond Discharge
Aluminum, mg/l	1.2	1.4	1.0	0.7
Ammonia as N, mg/l	0.05	0.11	0.04	1.3
Arsenic, mg/l	<0.005	0.060	<0.010	0.092
Barium, mg/l	<0.1	<0.1	<0.1	0.3
Beryllium, mg/l	<0.01	<0.01	<0.01	<0.01
Cadmium, mg/l	<0.001	<0.001	<0.001	<0.001
Calcium, mg/l	23	59	30	69
Chloride, mg/l	7	8	8	19
Chromium, mg/l	<0.005	<0.005	<0.005	<0.005
Conductivity, 25°C, umhos/cm	150	320	210	370
Copper, mg/l	<0.01	<0.01	0.03	0.04
Cyanide, mg/l	-	-	-	-
Hardness, mg/l	71	160	96	180
Iron, mg/l	1.2	0.26	1.7	0.20
Lead, mg/l	<0.010	<0.010	<0.010	<0.010
Magnesium, mg/l	3.4	3.0	5.0	3.0
Manganese, mg/l	0.07	<0.01	0.14	0.01
Mercury, mg/l	<0.0002	<0.0002	<0.0002	<0.0002
Nickel, mg/l	<0.05	<0.05	<0.05	<0.05
Phosphorous, mg/l	0.10	0.06	0.13	0.02
Selenium, mg/l	0.009	0.012	<0.002	0.003
Silica, mg/l	5.9	5.9	4.8	5.6
Silver, mg/l	<0.01	<0.01	<0.01	<0.01
Solids, Dissolved, mg/l	100	200	110	200
Solids, Suspended, mg/l	22	4	24	4
Sulfate, mg/l	16	59	24	91
Zinc, mg/l	<0.01	<0.01	0.04	0.03

Table A-17

TVA PLANT L RIVER WATER INTAKE AND COMBINED ASH POND DISCHARGE  
(Quarterly Samples)

Date	1/8/73		4/2/73		7/2/73		10/1/73	
	River Intake	Pond Discharge	River Intake	Pond Discharge	River Intake	Pond Discharge	River Intake	Pond Discharge
Aluminum, mg/l	NA	2.1	NA	2.2	NA	2.6	NA	1.8
Ammonia as N, mg/l	NA	0.37	NA	1.3	NA	0.20	NA	1.4
Arsenic, mg/l	NA	0.036	NA	0.030	NA	0.070	NA	0.070
Barium, mg/l	NA	<0.1	NA	0.1	NA	<0.1	NA	<0.1
Beryllium, mg/l	NA	<0.01	NA	<0.01	NA	<0.01	NA	<0.01
Cadmium, mg/l	NA	<0.001	NA	<0.001	NA	<0.001	NA	<0.001
Calcium, mg/l	NA	44	NA	38	NA	91	NA	53
Chloride, mg/l	NA	6	NA	4	NA	6	NA	9
Chromium, mg/l	NA	0.009	NA	0.007	NA	<0.005	NA	0.009
Conductivity, 25°C, umhos/cm	NA	120	NA	270	NA	330	NA	360
Copper, mg/l	NA	<0.01	NA	<0.01	NA	0.01	NA	<0.01
Cyanide, mg/l	NA	<0.01	NA	<0.01	NA	<0.01	NA	<0.01
Hardness, mg/l	NA	130	NA	110	NA	240	NA	150
Iron, mg/l	NA	0.90	NA	1.0	NA	0.54	NA	0.58
Lead, mg/l	NA	<0.010	NA	0.043	NA	<0.010	NA	<0.010
Magnesium, mg/l	NA	3.9	NA	4.0	NA	4.2	NA	3.5
Manganese, mg/l	NA	<0.01	NA	0.06	NA	<0.01	NA	<0.01
Mercury, mg/l	NA	0.0009	NA	0.0005	NA	-	NA	<0.0002
Nickel, mg/l	NA	<0.05	NA	<0.05	NA	<0.05	NA	<0.05
Phosphorous, mg/l	NA	0.19	NA	0.03	NA	0.45	NA	0.42
Selenium, mg/l	NA	<0.004	NA	0.013	NA	0.013	NA	0.014
Silica, mg/l	NA	5.6	NA	5.0	NA	5.9	NA	5.4
Silver, mg/l	NA	<0.01	NA	<0.01	NA	<0.01	NA	<0.01
Solids, Dissolved, mg/l	NA	230	NA	190	NA	240	NA	230
Solids, Suspended, mg/l	NA	11	NA	8	NA	3	NA	5
Sulfate, mg/l	NA	100	NA	60	NA	75	NA	110
Zinc, mg/l	NA	0.04	NA	0.02	NA	0.03	NA	0.02

A-56

NA = Not Available

Table A-17 (Continued)

TVA PLANT L RIVER WATER INTAKE AND COMBINED ASH POND DISCHARGE  
(Quarterly Samples)

Date	1/15/74		4/9/74		7/16/74		10/22/74	
	River Intake	Pond Discharge	River Intake	Pond Discharge	River Intake	Pond Discharge	River Intake	Pond Discharge
Aluminum, mg/l	2.8	2.0	2.3	2.5	0.7	2.2	0.3	1.3
Ammonia as N, mg/l	0.04	0.60	0.05	0.46	0.07	0.06	0.08	0.73
Arsenic, mg/l	<0.005	0.045	<0.005	0.010	<0.005	0.015	0.010	0.010
Barium, mg/l	0.1	<0.1	0.2	0.2	0.2	0.2	<0.1	<0.1
Beryllium, mg/l	<0.01	<0.01	<0.01	<0.01	<0.01	<0.01	<0.01	<0.01
Cadmium, mg/l	<0.001	<0.001	<0.001	<0.001	<0.001	0.004	<0.001	<0.001
Calcium, mg/l	14	60	17	72	17	47	17	32
Chloride, mg/l	4	4	4	4	6	6	8	8
Chromium, mg/l	0.021	0.005	<0.005	0.010	<0.005	0.010	0.010	0.012
Conductivity, 25°C, umhos/cm	110	300	130	560	170	310	180	270
Copper, mg/l	0.14	0.07	0.10	0.08	0.04	0.14	<0.01	<0.01
Cyanide, mg/l	-	<0.01	-	<0.01	-	<0.01	-	-
Hardness, mg/l	50	160	56	190	60	130	61	92
Iron, mg/l	2.40	0.87	1.9	0.85	0.61	0.38	0.28	0.41
Lead, mg/l	0.02	<0.010	0.012	<0.010	0.014	0.036	<0.010	<0.010
Magnesium, mg/l	3.7	2.0	3.4	1.3	4.3	2.6	4.4	3.0
Manganese, mg/l	0.12	<0.01	0.08	0.01	0.05	<0.01	0.03	<0.01
Mercury, mg/l	0.0002	<0.0002	<0.0002	0.0002	<0.0002	<0.0002	<0.0002	<0.0002
Nickel, mg/l	<0.05	<0.05	<0.05	<0.05	<0.05	<0.05	<0.05	<0.05
Phosphorous, mg/l	0.01	0.01	0.06	0.02	0.02	0.08	0.04	0.05
Selenium, mg/l	<0.002	0.014	<0.002	0.008	<0.002	<0.002	<0.002	<0.002
Silica, mg/l	5.2	5.2	5.4	6.7	3.6	-	5.1	5.3
Silver, mg/l	<0.01	<0.01	<0.01	<0.01	<0.01	<0.01	<0.01	0.01
Solids, Dissolved, mg/l	80	220	80	230	90	230	100	150
Solids, Suspended, mg/l	30	27	43	50	8	9	4	4
Sulfate, mg/l	11	80	15	90	14	110	14	55
Zinc, mg/l	0.08	0.02	0.07	0.06	0.04	0.05	0.05	0.05

A-57

Table A-17 (Continued)

TVA PLANT L RIVER WATER INTAKE AND COMBINED ASH POND DISCHARGE  
(Quarterly Samples)

Date	1/21/75		4/15/74		7/9/75	7/16/75	10/14/75	
	River Intake	Pond Discharge	River Intake	Pond Discharge	River Intake	Pond Discharge	River Intake	Pond Discharge
Aluminum, mg/l	1.0	1.5	1.4	2.3	0.7	2.1	0.7	1.7
Ammonia as N, mg/l	0.05	0.45	0.06	0.29	0.07	0.29	0.04	0.14
Arsenic, mg/l	<0.005	0.033	<0.005	0.035	<0.005	0.030	<0.005	0.005
Barium, mg/l	<0.1	<0.1	0.2	0.2	<0.1	<0.1	<0.1	<0.1
Beryllium, mg/l	<0.01	<0.01	<0.01	<0.01	<0.01	<0.01	<0.01	<0.01
Cadmium, mg/l	<0.001	<0.001	<0.001	0.002	0.001	<0.001	<0.001	<0.001
Calcium, mg/l	13	42	15	42	21	63	19	62
Chloride, mg/l	6	8	4	4	7	5	7	4
Chromium, mg/l	0.012	0.018	0.005	0.016	<0.005	<0.005	<0.005	<0.005
Conductivity, 25°C, umhos/cm	150	410	140	320	150	360	150	420
Copper, mg/l	0.02	<0.01	0.06	0.12	0.08	0.10	0.08	0.09
Cyanide, mg/l	-	<0.01	-	-	-	-	-	-
Hardness, mg/l	46	120	53	110	70	160	64	160
Iron, mg/l	0.84	0.48	1.1	0.30	0.66	0.36	0.45	<0.05
Lead, mg/l	0.018	<0.010	0.032	0.031	<0.010	<0.010	<0.010	0.010
Magnesium, mg/l	3.4	2.7	3.7	1.8	4.2	1.4	4.0	0.4
Manganese, mg/l	0.07	0.13	0.07	0.07	0.07	0.01	0.04	<0.01
Mercury, mg/l	<0.0002	<0.0002	<0.0002	<0.0002	<0.0002	<0.0002	<0.0002	<0.0002
Nickel, mg/l	<0.05	<0.05	<0.05	<0.05	<0.05	<0.05	<0.05	<0.05
Phosphorous, mg/l	0.03	0.03	0.03	-	0.04	0.04	0.04	0.02
Selenium, mg/l	<0.002	0.020	<0.002	0.013	<0.002	0.010	<0.001	0.010
Silica, mg/l	5.1	4.5	5.8	7.1	5.0	9.1	5.3	8.5
Silver, mg/l	<0.01	<0.01	<0.01	<0.01	<0.01	<0.01	<0.01	<0.01
Solids, Dissolved, mg/l	90	260	70	180	90	230	100	140
Solids, Suspended, mg/l	12	11	9	7	5	3	4	3
Sulfate, mg/l	16	6	12	100	9	110	9	67
Zinc, mg/l	0.06	0.04	0.09	0.06	0.03	0.03	0.07	0.02

A-58

APPENDIX B

CHLORINE MINIMIZATION PROGRAM  
FOR ONCE-THROUGH COOLING WATER



## APPENDIX B

### CHLORINE MINIMIZATION PROGRAM FOR ONCE-THROUGH COOLING WATER

#### PURPOSE

The purpose of chlorine minimization is to reduce the discharge of chlorine or its related compounds to receiving waters. This description is intended to explain what a chlorine minimization program is and how to develop and implement one. Anticipated situational factors and how to approach them are also presented.

#### BACKGROUND

Chlorine is commonly added to condenser cooling water of steam electric facilities in order to control the growth of various organisms (algae, bacteria, barnacles, clams) that would otherwise attach to surfaces in the condenser, cooling towers, or to other components of the cooling system and prevent the system from functioning properly.

The attachment of these various organisms to the cooling water system is called biofouling. Since the control method using chlorine involves creating a residual dose of reactive chlorine, some of the chlorine used to control biofouling is still present when the cooling water is discharged from the plant. It is desirable to minimize the discharge of free and combined residual chlorine from steam electric powerplants due to the toxicity these compounds have on aquatic life.

Various powerplants have undertaken some type of program to reduce the use of chlorine. The results of these programs indicate that significant chlorine reduction can be achieved in many cases. Some of the plants found that chlorination is not required at all while others have found that the amount of chlorine added can be significantly reduced, especially during the winter months.

### GENERAL APPROACH

In order to determine the minimum amount of chlorine a specific powerplant requires, a chlorine minimization study must be undertaken. A chlorine minimization study may require up to eighteen months. The first step is the selection of the most appropriate minimization strategy, which may take up to six months. During this period, each of the following three variables is controlled at various levels until the minimum value that permits proper plant performance is determined

1. Dose of chlorine added - where dose is defined as the total amount of chlorine added per unit volume of cooling water.
2. Duration of chlorine addition - where duration is defined as the length of time between the start and end of a single period of chlorine addition.
3. Frequency of chlorination - where frequency is defined as the number of periods of chlorine addition per day or week.

During the trials of various combinations of dose, duration, and frequency, data on plant performance must be



collected. These data may include condenser vacuum, generator output, and the cooling water temperature rise as well as pressure drop across the condenser. The performance data can be analyzed to determine if proper plant performance is being maintained. Different plants will necessarily employ different measures of performance to ensure that conditions specific to that plant are taken into account. Starting from operational practices known to maintain satisfactory performance of the cooling system, the systematic approach described in the following sections would be used to select the optimum chlorine minimization strategy. This optimum strategy determines the manner in which dose, duration, and frequency are best varied to maintain system performance.

After the optimal minimization strategy has been determined, a full year of application of the optimal strategy is required to define the minimum dose and duration as well as optimum frequency to be used during any portion of the year. The optimal chlorination procedure will vary with the seasons of the year due to changes in the chemical, physical, and biological characteristics of the cooling water source. Water temperature is an especially important variable, as the growth rate of many microorganisms drops rapidly with decreasing water temperature. Therefore, many plants have found they do not need to chlorinate at all during the winter months.

At the end of a full year of study, the proper chlorination procedure for each season of the year will have been defined and the chlorine minimization program will officially cease. At this point, the proper chlorination procedure is based upon the data collected during the previous years program. System performance data must still be collected periodically to check the adequacy of the procedure and to enable any needed changes to be made.

It is important to mention that plants have some additional ways of reducing chlorine use besides conducting a formal minimization program. For example, chlorine need not always be applied to the entire cooling system. Although biological growth occurs in all segments of the cooling system, the most sensitive portion is usually the condenser. Biological growth in the other segments does not generally impair the operation and efficiency of the plant with the exception of plants with encrustations of macroinvertebrates (barnacles, clams) in the intake system. The relocation of the point of chlorine addition to the condenser inlet box, providing sufficient mixing of chlorine occurs, can result in significant reduction in the quantity of chlorine required to achieve the necessary level of free available chlorine at the condenser outlet. Chlorine addition, however, is required in the cooling water intake structure and other sections of the cooling system for plants with macroinvertebrate fouling problems. Most experience has demonstrated that the continuous application of chlorine is necessary to gain control of both larval and adult forms of the macroinvertebrates where they occur on the intake structure, intake tunnels, and intake water boxes. Chlorine minimization in such instances involves applying chlorine only during the growing season and at the lowest concentrations necessary to achieve control. Visual inspection is the most usual and reliable method of measuring the chlorine effectiveness. For new facilities, the option of utilizing heat treatment to resolve this problem should be explored.

Another method of reducing chlorine use that falls outside the scope of a formal minimization program is the use of a mechanical condenser antifouling device (mechanical cleaning). Some plants using on-line mechanical cleaning do not chlorinate at all; others still require chlorine addition to the critical

components of the cooling system. For existing plants, the retrofiting of a mechanical cleaning system may be expensive. For new plants, costs of a mechanical cleaning system are lower since no retrofit is needed. New plants should seriously consider the use of a condenser mechanical cleaning system.

#### SYSTEMATIC APPROACH FOR DETERMINING MINIMUM AMOUNT OF CHLORINE ADDITION

As explained in the preceding discussion, the control variables are dose, duration, and frequency. During the optimal strategy development stage, these factors must be varied in a systematic fashion. Throughout this period the operating integrity of the plant must be protected. To accomplish this, plant operators will need to establish some absolute means of monitoring condenser performance. If at all possible, provisions should be made to enable visual inspection of the condenser elements following a test period. The actual condition of the system in terms of biofouling can then be directly compared to the indirect means of monitoring performance (condenser vacuum, pressure drop, etc.). Actual inspection of the condenser or other part of the cooling system (which requires plant closure or loading reduction) should not be considered to be a 'routine' method of evaluating the effectiveness of the chlorine addition program as unit downtime to make such inspections is costly and highly undesirable from the operator's standpoint.

The following sections provide additional details concerning (1) the specific things each plant must be capable of in order to conduct a minimization program, (2) the specific steps that make up a minimization program, and (3) how a plant should use the results of a minimization program to control future chlorine use.

1. Required Capabilities

- a. A means of measuring the apparent waterside condenser tube fouling. This should include visual inspections and biofouling sampling at some point in the test program. Inspection should include the condenser tubes, intake tube sheet, water boxes and, if needed, the cooling water intake structure. Other measurements may be substituted with caution such as deviation from expected condenser vacuum, pressure drop, etc. The substitute measurements all have serious problems of ambiguity since many factors other than biofouling film growth in the condenser tubes can affect these measurements.
- b. A means of relating the periodic inspection result or other measurements to condenser performance.
- c. A means of gathering grab samples from condenser inlet, outlet, and NPDES discharge point.
- d. A means of measuring free available chlorine (FAC) and total residual chlorine (TRC) on samples without delay once collected. The test method to be employed is ASTM D 1253 Chlorine in Water, Method A, Direct Amperometric Titration.

- e. A means of controlling and measuring with appropriate accuracy the addition of chlorine to the cooling water to the unit or condenser under study. The arrangement for adding chlorine varies considerably from plant to plant. The physical differences may influence the minimization strategy and may require physical modification of the existing system in order to properly implement the program.
- f. General chemical analytical capability for properties or substances in water.
- g. A means of determining short-term free available chlorine demand of the inlet water either in the laboratory or by difference between applied chlorine concentration and the free available chlorine residual found at the condenser inlet.

## 2. Specific Steps in a Minimization Program

- a. Establish a baseline of condenser performance associated with the condenser for each seasonal period of plant operation (winter, summer, etc.). This may involve an initial offline chemical or mechanical cleaning. It is necessary that these baseline conditions be used to evaluate the results of the various chlorination strategies. Data needed to establish baseline conditions will be available at most facilities, and thus, will not require a delay in systematic testing of minimization strategies.

- b. Conduct screening tests for a length of time to be determined by plant operators. A period of two months for each of the strategies tested is probably appropriate. Different plant cooling water and chlorine feed configurations may require alterations in the selection of the minimization strategies. Plants with several units with similar tube metal, intake water, transit times, temperature gradient across the condensers and cooling water velocity may allow parallel trials of the minimization strategies on several units while maintaining other units on the dose, frequency and duration found effective in past experience. The duration of plant chlorination should be restricted to a maximum of two hours per day.

There are three basic ways to institute a chlorine minimization program (i) reduce the dose, (ii) reduce the duration, or (iii) change the frequency. For many facilities it may be desirable to conduct all three alternatives in succession prior to selecting the most suitable. In some cases the operator can choose one alternative based on previous experience. The three alternative approaches are explained in detail as follows:

- (i) Reduction of Dose: Establish a desired outlet concentration for TRC. This value should be lower than 0.14 mg/l. Maintain the frequency and duration

found effective in past experience but reduce the dose of chlorine until the desired effluent concentration is not exceeded. Closely monitor condenser performance parameters during this period. If the system shows signs of biofouling, increase the dose. Test periods of about two months should be used for evaluating effectiveness of each new dose used.

(11) Reduction of Duration Decrease the duration of chlorine feed while maintaining the dose and frequency found effective in past experience. Again, test periods of two months are probably adequate to evaluate a particular duration strategy.

(111) Change the Frquency. Frequency changes with the goal of minimization can be made in two ways (1) reduce the frequency while keeping dose and duration at baseline values, or (2) increase the frequency but simultaneously decrease the duration. For example, increase frequency from one to three times per day while reducing duration from one hour to 10 minutes. Test periods of two months are probably adequate to evaluate a particular change in frequency.

- c. From the short term screening tests, select the approach that appears to best fulfill the purposes of the chlorine minimization program. Using the selected strategy, conduct a year-long trial making appropriate adjustments in the dose, duration, and frequency to meet the changing intake water chlorine demand and biofouling propensity so as to maintain acceptable plant performance.

The entire test program, from start to finish, should not require more than 18 months.

### 3. Using the Results of the Minimization Program

- a. The information obtained in the 18 month chlorine minimization program should serve as the guidelines for a permanent chlorination procedure. The most successful approach (the method that provides for adequate plant performance while minimizing chlorine discharge) should be implemented.
- b. The implementation program should take into account both year-to-year and seasonal variations in water quality. For example, as was done in the minimization program, each season of the year should be approached as a new set of operating conditions. Different combinations of dose, duration and frequency may be



applied in each season. The optimum combinations for each season being those defined by the chlorine minimization study during that season. Long term year to year variations in water quality may require changes in dose, duration, and frequency not encountered during the minimization test program.

- c. Monitoring of condenser performance indicators (condenser vacuum, etc.) should continue during the implementation plan. This is necessary to prevent serious biofouling (and potential plant shutdown) in the event that the influent cooling water quality or plant operating characteristics undergo a sudden change that increases the plant's susceptibility to biofouling.



APPENDIX C

STATISTICAL EVALUATION OF CHLORINE MINIMIZATION  
AND DECHLORINATION



## APPENDIX C

### STATISTICAL EVALUATION OF CHLORINE MINIMIZATION AND DECHLORINATION

#### INTRODUCTION

Chlorine is one of the pollutants identified in the effluent of steam electric generating plants. It is used intermittently in the cooling waters of generating stations to kill organisms which interfere with the operation of a plant. Chlorine is added to the cooling water in batches at such times as biofouling becomes an operational problem. Because chlorination is a batch process, chlorine in a plant's effluent is of concern only during and immediately after the period of chlorination.

The effluent guidelines for steam electric plants are to include standards for chlorine concentrations. Control options which may be applied to reduce effluent chlorine concentrations include chlorine minimization (use of the least amount of chlorine needed without impairing operation of the plant) and dechlorination of the effluent.

Three plants have provided data to EPA on chlorine concentrations under no-control, minimization and dechlorination (where dechlorination may include some level of chlorine minimization as well) to the EPA. The purpose of the analysis of this data is to describe the performance of these treatment methods, and to establish standards for the discharge of chlorine.

#### Conclusion

The analysis performed on this data was to determine limitations on the maximum measured concentration. The Agency bases such limitations on the 99th percentile of the distribution of daily effluent concentrations. The 99th percentile estimates have been computed for each plant, within each level of treatment. These resulting values are the basis for selecting the chlorine limitation. (See text for further explanation.)

Table 1

	<u>TRC (mg/l)</u>
Treatment Type: No Controls	0.34
Chlorine Minimization	0.20
Dechlorination	0.14

## Descriptive Statistics

The data are from three steam electric generating plants in Michigan and cover the period from January 1977 through December 1978. The data include periods of no controls on chlorine (January-May 1977), chlorine minimization only (June-October 1977) and dechlorination (November 1977-December 1978). Data exist for each plant, for each day on which the plant performed chlorination. A single chlorination event is defined as any period in which chlorine is added to the cooling waters of a steam electric generating plant. For each chlorination event, a number of analyses of the effluents is performed. For each event, the following aggregate statistics were provided to the EPA: the number of samples taken, the maximum and minimum value of the effluent concentration and the average of the sample values. The number of distinct samples for each chlorination event ranges from 1 to over 20, with an average value of 6.24 samples/chlorination event. Concentrations of chlorine levels in the effluent are reported in milligrams per liter (mg/l) as Total Residual Chlorine (TRC).

Data for the most part, were used as they appeared on the monitoring reports of the plants. Three data points were deleted because they were taken on days of known equipment malfunctions, a fourth point was removed because of an apparent reporting error (the dates of edited points were 6/1/77, 7/10/77, 9/30/77 and 10/29/77). The number of chlorination events, for each plant, and within each level of treatment is reported in table 2.

Table 2

### The Number of Chlorination Events

<u>Treatment</u>	<u>Plant 2608</u>	<u>Plant 2607</u>	<u>Plant 2603</u>
No Controls	56	44	103
Chlorine Minimization	58	94	87
Dechlorination	52	183	261
Total	166	331	451

The form in which the data were reported (minimum, maximum, average, and number of samples taken), as well as the character of the data, limits the kinds of analyses that can be performed on this data. Often, observations of pollutant levels are log normally distributed. The chlorine levels for the maximum, minimum and average values reflect a high degree of skewness, illuminating the fact that this data does not arise from a log normal distribution.

If the underlying distribution were log normal, it would be a truncated log normal, with a large probability mass at zero. In table 3, the occurrence of the large percentage of zero values is made explicit.

Table 3

Percentage of Average ( $\bar{X}$ ) and Maximum (Max.)  
Values Equaling Zero

<u>Treatment</u>	<u>Plant 2608</u>		<u>Plant 2607</u>		<u>Plant 2603</u>	
	<u>% of <math>\bar{X}</math></u>	<u>% of Max</u>	<u>% of <math>\bar{X}</math></u>	<u>% of Max</u>	<u>% of <math>\bar{X}</math></u>	<u>% of Max</u>
No Controls	3.6	3.6	15.9	15.9	0	0
Chlorine Minimiza- tion	3.4	0	25.5	18.1	2.3	2.3
Dechlori- nation	75.0	51.9	54.9	49.7	52.1	51.7
Total	25.9	17.5	41.4	36.3	30.6	30.4

Without imposing strict distributional requirements on this data, it may be asserted that the data (both maximum and average values) are highly skewed in favor of the lower tail, with the level of skewness increasing with more stringent controls. Histograms and plots of the empirical distribution function provide evidence of large skewness. The histograms for Plants 2608, 2607 and 2603 are shown in figures 1, 2 and 3 respectively. Each figure consists of six histograms (labeled a through f) as follows

- a - Histogram of maximum TRC values with no controls.
- b - Histogram of average TRC values with no controls.
- c - Histogram of maximum TRC values with chlorine minimization.
- d - Histogram of average TRC values with chlorine minimization.
- e - Histogram of maximum TRC values with dechlorination.
- f - Histogram of average TRC values with dechlorination.

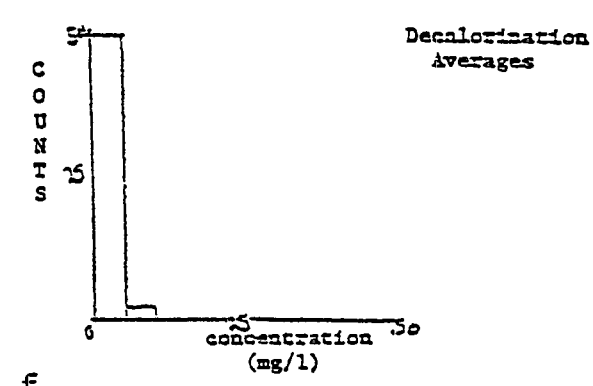
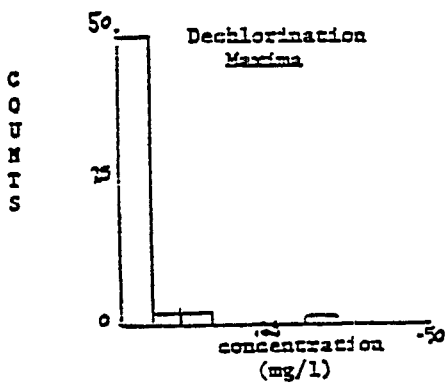
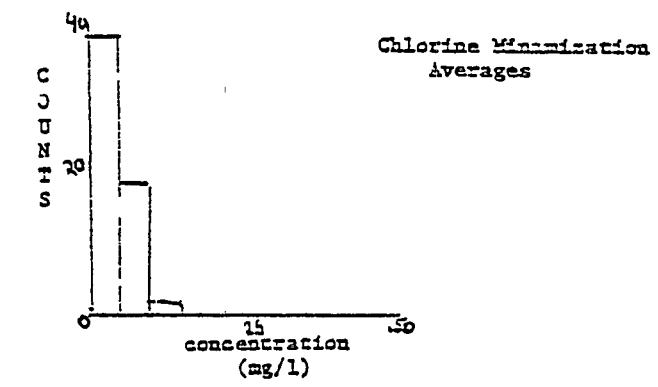
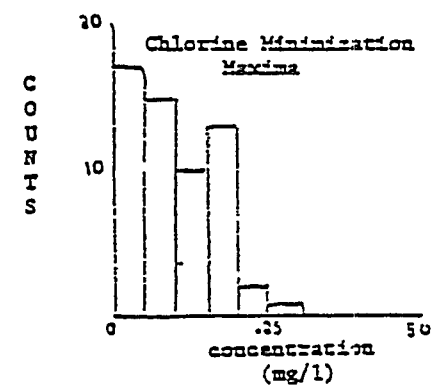
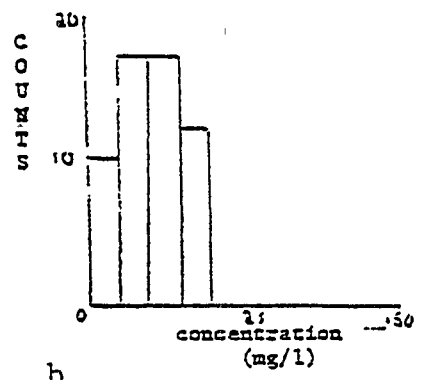
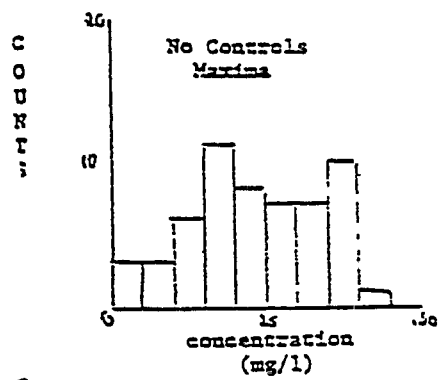

Figure 1  
HISTOGRAMS FOR PLANT 2608



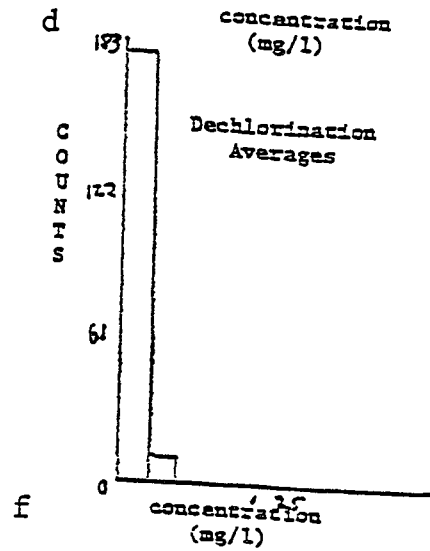
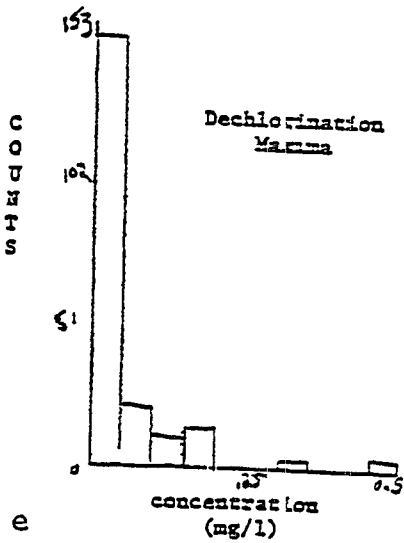
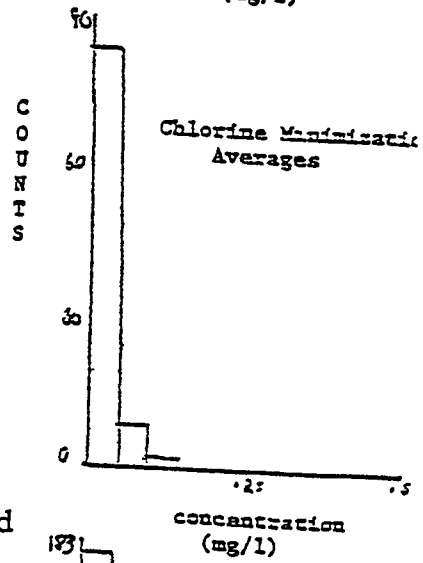
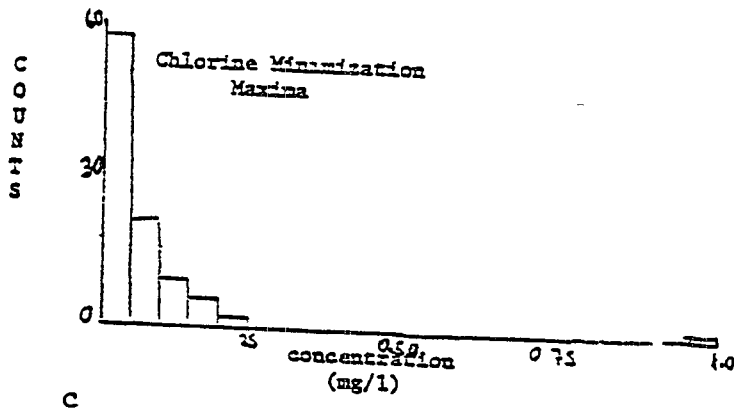
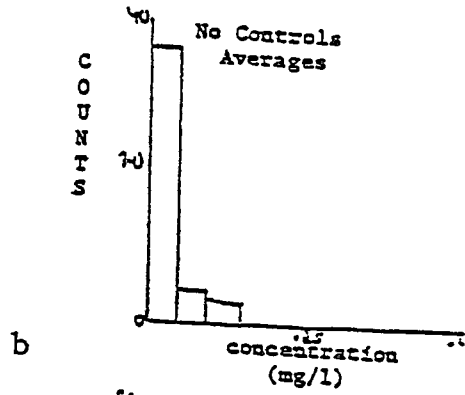
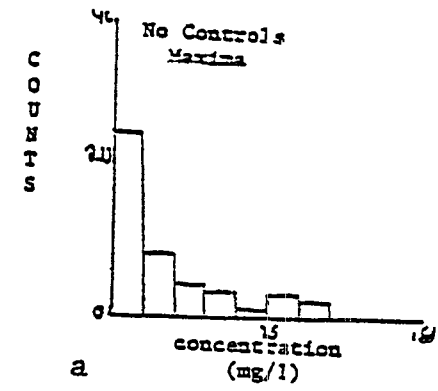

Figure 2  
HISTOGRAMS FOR PLANT 2607

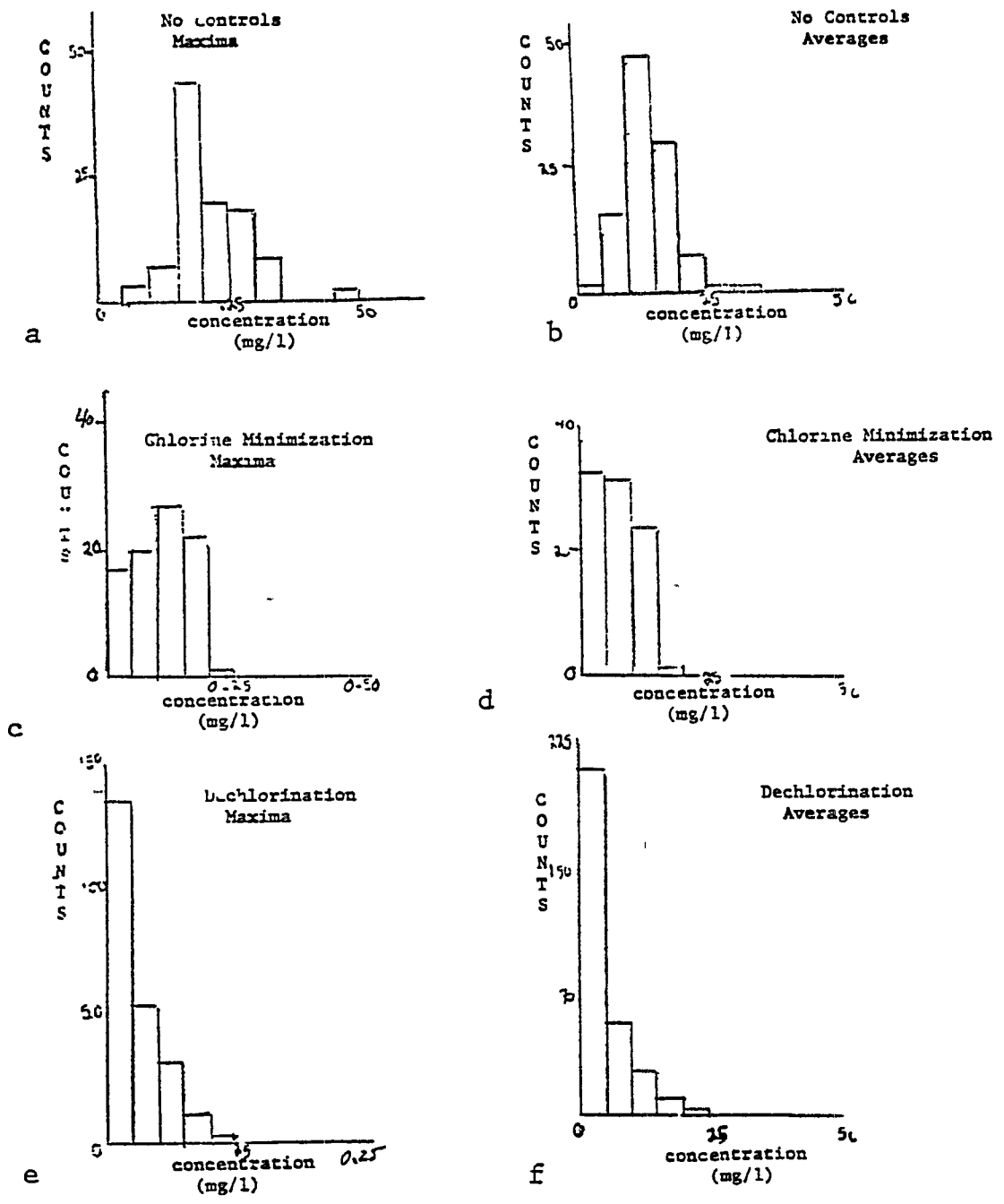

Figure 3  
 HISTOGRAMS FOR PLANT 2603

The empirical distribution functions for Plants 2608, 2607 and 2603 are shown in figures 4, 5 and 6, respectively. Each figure consists of six distribution functions (labeled a through f) in the same format as the histograms.

The data were investigated for long term average performance. From the information reported by the plant, a weighted mean has been computed. This estimate is based on the number of samples taken for any single chlorination event, and the average for the chlorination event. The mean has been computed for each plant, within each level of treatment.

Table 5

<u>Treatment</u>	<u>Weighted Mean TRC (mg/l)</u>		
	<u>Plant 2608</u>	<u>Plant 2607</u>	<u>Plant 2603</u>
No Controls	.1047	.0264	.1459
Chlorine Minimization	.0392	.0150	.0765
Dechlorination	.0080	.0122	.0375

Since the data are reported in this aggregated form, the conventional estimator of the standard deviation of the chlorine measurement can not be applied. Assumed that

$$\text{Var } X_{1j} = \sigma^2$$

And that the  $X_{1j}$  are statistically independent. It follows that an unbiased estimator of  $\sigma^2$  is

$$s^2 = \left\{ \sum_{i=1}^I (\bar{X}_i - \bar{X})^2 / (1/n_i - 1/\sum_1 n_i) \right\} / I$$

where  $n_i$  = the number of observations for the  $i$ th chlorination event. Estimates of  $\sigma$  are presented in table 6.

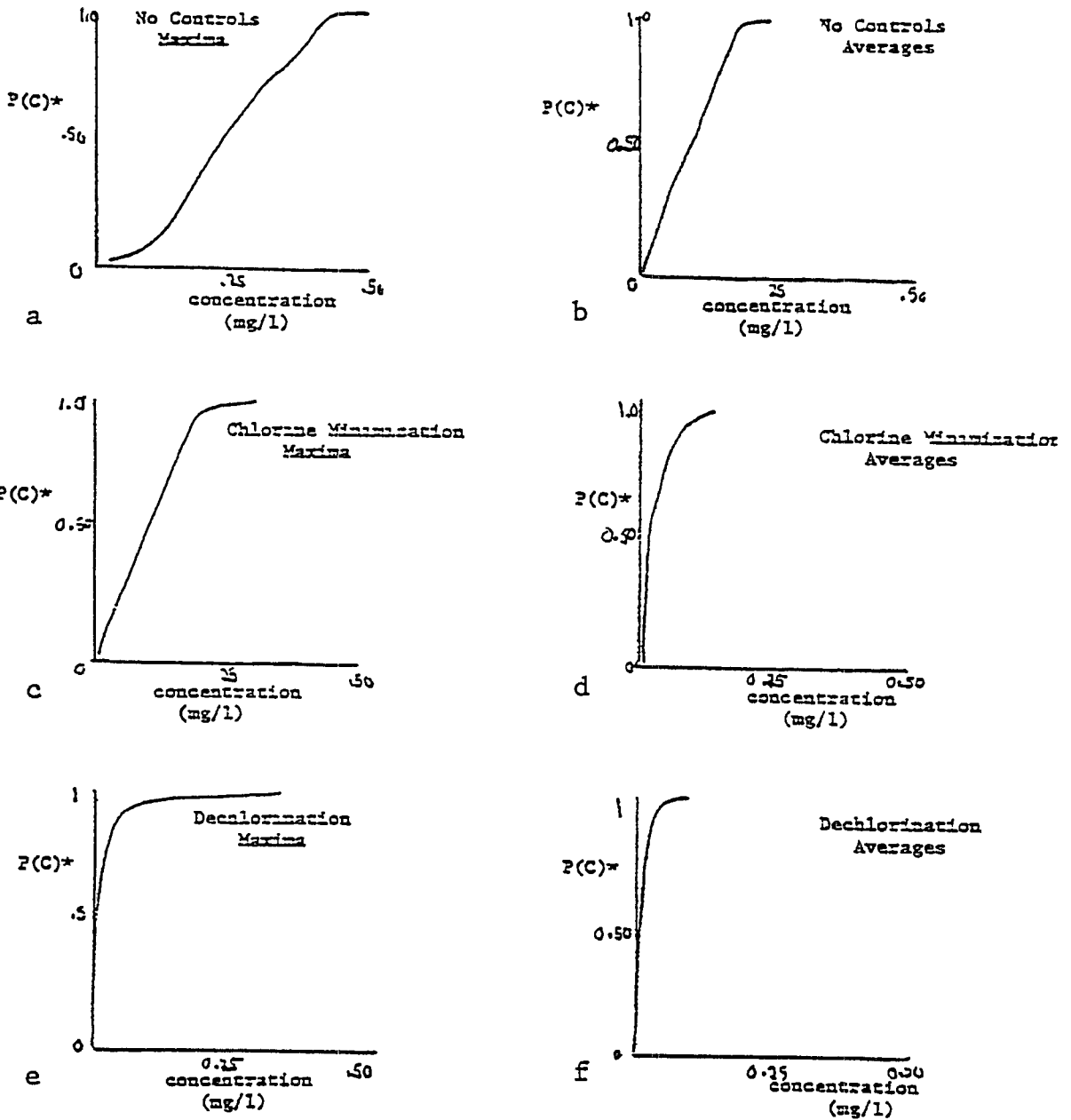

Figure 4

EMPIRICAL DISTRIBUTION FUNCTIONS FOR PLANT 2608

\* $P(C)$  = proportion less than are equal to concentration C.

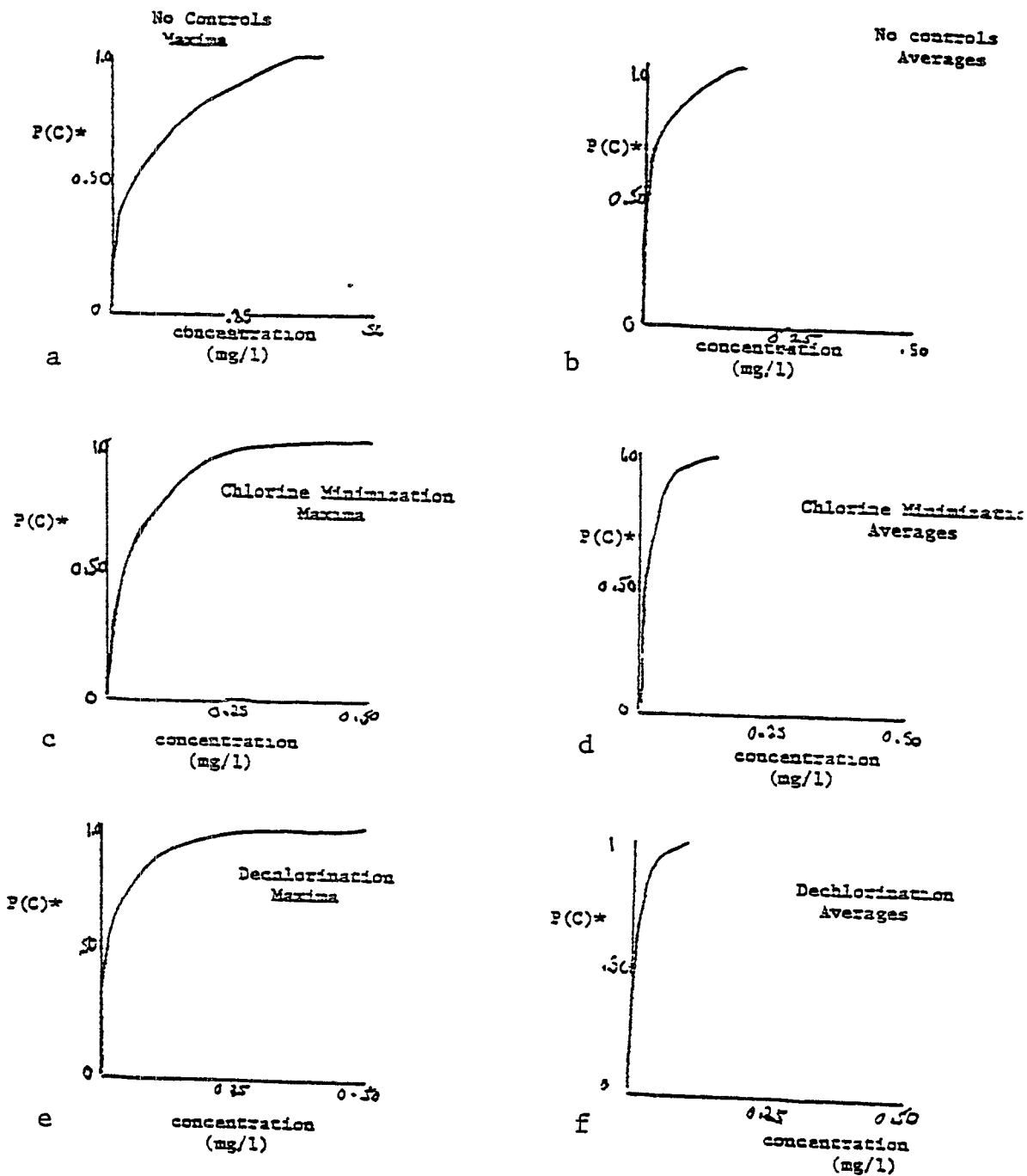

Figure 5

EMPIRICAL DISTRIBUTION FUNCTIONS FOR PLANT 2607

\* $P(C)$  = proportion less than or equal to concentration C

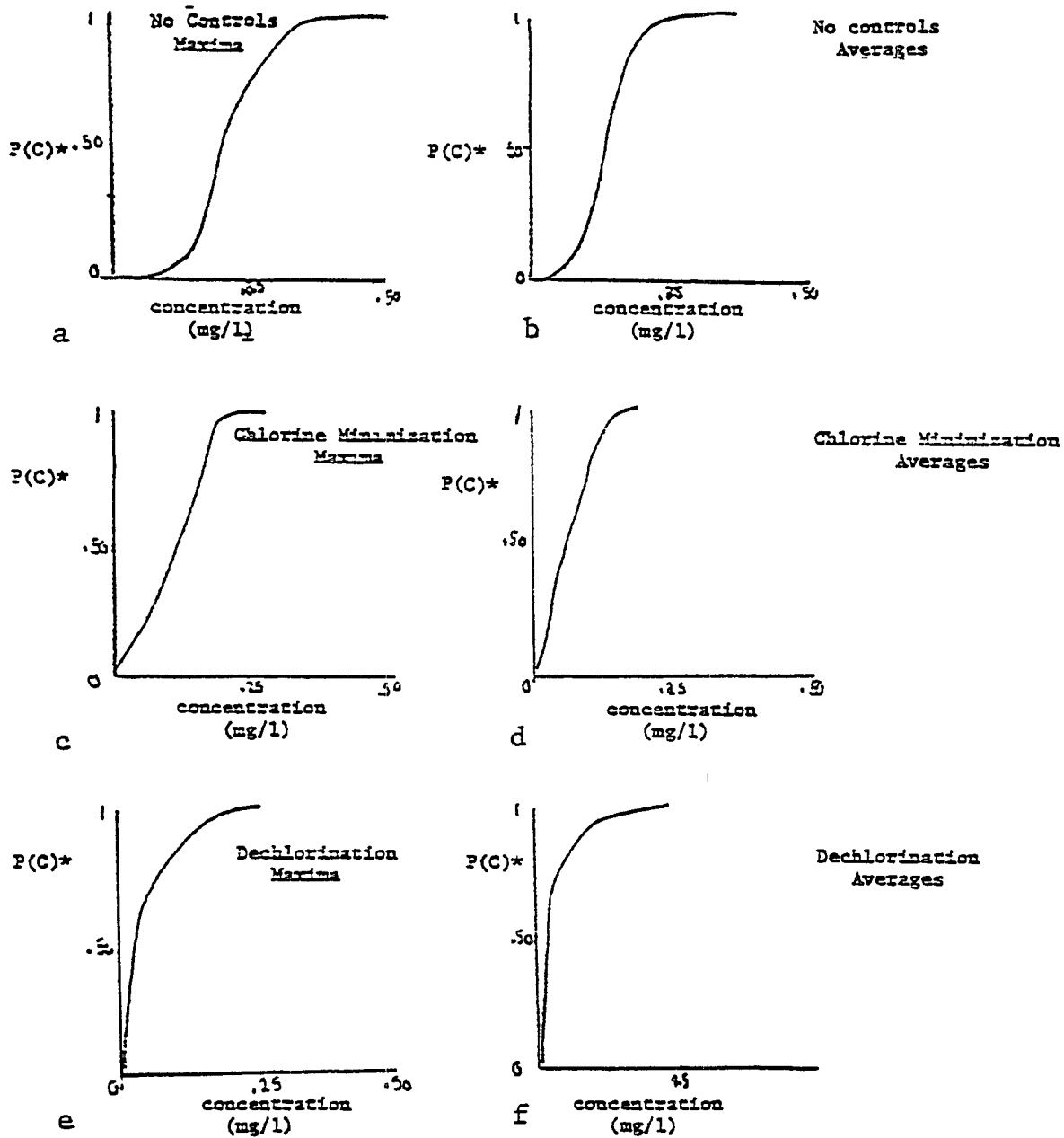

Figure 6

EMPIRICAL DISTRIBUTION FUNCTION FOR PLANT 2603

\* $P(C)$  = proportion less than or equal to concentration C.

Table 6

Standard Deviation

<u>Treatment</u>	<u>Plant 2608</u>	<u>Plant 2607</u>	<u>Plant 2603</u>
No Controls	.7257	.3834	.4531
Chlorine Minimization	.1774	.2349	.2663
Dechlorination	.0912	.2307	.4218

The medians and grand means for the results are found in table 7.

The computation for the estimate of the standard deviation is not as straight-forward as the mean, because individual sample points are not known. For a given plant, let  $X_{1j}$  be the observed chlorine concentration for chlorination event 1 and for  $j = 1, 2, \dots, n_1$ . For each chlorination event, the available data are as follows

1. The mean TRC concentration of each chlorination event ( $X_1$ ), where the mean is calculated using the following equation

$$\bar{X}_1 = 1/n_1 \sum_{j=1}^{n_1} X_{1j}$$

2. The maximum TRC concentration measured during each chlorination event ( $X_{1j}$  max).

3. The minimum TRC concentration measured during each chlorination event ( $X_{1j}$  min).

4. The number of samples collected during each chlorination event ( $n_1$ ).

Table 7

Weighted Means and Median of Estimated Standard  
Deviation for Treatment Type (Plant Independent)

<u>Treatment</u>	<u>Median</u>	<u>Mean</u>
No Controls	.4531	.4765
Chlorine Minimization	.2349	.2398
Dechlorination	.2307	.2972

Derivation of Recommended Standards

A daily maximum permissible value is generally based on estimates of the 99th percentile of the distribution of effluent concentrations. It is hypothesized that  $X_{1j} \sim F_0$  ( $F_0$  is unspecified). The 99th percentile is defined as  $x_0$  such that  $F_0(x_0) = .99$  ( $x_0 = F_0^{-1} [.99]$ ).

$$I_1(X_{(n_1)}) = \begin{bmatrix} 1 & X_{(n_1)} < x_0 \text{ where } X_{(n_1)} \\ & \text{is the maximum observation} \\ & \text{for the } i\text{th chlorination event.} \\ 0 & \text{Otherwise} \end{bmatrix}$$

It is noted that if  $X_{(n_1)} < x_0$ , then for that chlorination event, all  $X_{1j} < x_0$ . Hence

$$E(I_1) = .99n_1$$

$x_0$  is estimated for each plant by selecting that value such that

$$E(\sum_i I_i) = E\sum_i (I_1) = \sum_i .99n_1$$

The nearest integer greater than or equal to  $\sum_i .99n_1$  is the rank of that data value (among the set of maximum values) which will be set equal to  $x_0$ . Therefore,  $I_1$ , defined relative to  $x_0$  satisfies the condition that  $\sum_i I_1$  (in expectation) =  $\sum_i .99n_1$ . The estimation procedure required solving for  $\sum_i .99n_1$ , ranking the data values within a treatment type and within a plant and assigning to  $x_0$ , that value whose rank is  $[\sum_i .99n_1]$ . The ranks and the 99th percentile estimates for daily maxima appear in table 8 and 9 respectively.



Table 8  
Computation of .99n<sup>1</sup>

<u>Treatment</u>	<u>Plant 2608</u>	<u>Plant 2607</u>	<u>Plant 2603</u>
No Controls	51.83	40.45	99.27
Chlorine Minimization	53.40	86.97	83.27
Dechlorination	49.38	179.32	246.46

Table 9

99th Percentile Estimates for a Daily Maximum

<u>Treatment</u>	<u>Plant 2608</u>	<u>Plant 2607</u>	<u>Plant 2603</u>
No Controls	.38	.30	.34
Chlorine Minimization	.20	.20	.20
Dechlorination	.09	.16	.14

(Note that all data points are reported accurately to the second decimal place, hence, percentile points based on the observed data will be reported as a two digit number. However, an improvement could be made, albeit slight, if an interpolation procedure were applied to the data point associated with the observed value of .99n<sup>1</sup> and the adjusted value of that quantity.)

The basis for formulating effluent limitations is to use the medians, across plant, of the 99th percentile points. These values are reported in table 1.



APPENDIX D  
INDUSTRY COMPLIANCE WITH CHLORINATION OPTION



## APPENDIX D

### INDUSTRY COMPLIANCE WITH CHLORINATION OPTION

In order to estimate the percentage of chlorinating plants using once-through cooling systems that would be able to comply with the regulatory option, the available data on previously conducted chlorine minimization studies were evaluated. Data are available for a total of 25 plants using once-through cooling systems that conducted minimization studies. The available data have been summarized in Table D-1. The information in the table describes the plant structure and plant operating conditions at the conclusion of the minimization study. It can be assumed these plant operating conditions represent the minimum levels of chlorine use achievable at each plant. The table includes such information as:

- o Whether the plant is single unit or multiple units
- o The dose of chlorine being applied to the cooling water at the conclusion of the minimization study
- o The chlorine concentration found at the condenser outlet
- o The chlorine concentration (either as FAC or TRC) found at the plant's discharge point
- o Whether or not the plant dilutes chlorinated cooling water with unchlorinated cooling water before samples are collected
- o The general quality of the cooling water
- o Whether or not the plant has experienced biofouling problems as a result of operating at the point of minimum chlorine use
- o The appropriate reference for the data for each plant

The percentage of plants able to comply with the regulation was estimated through a series of steps. First, the data for all 25 plants were examined to determine the number of plants for which adequate data was available to be able to determine if that particular plant would be able to comply with the regulatory option. In many cases, the necessary data are not available. The second step was to examine in detail each plant for which the required data were available and determine how the plant

Table D-1

SUMMARY OF CHLORINE MINIMIZATION STUDIES AT POWER PLANTS  
USING ONCE-THROUGH COOLING SYSTEMS

Plant Number	Number of Units	Chlorine Dosage/Concentration* (mg/l)			Point of Water Dilution	Quality of Cooling Water	Biofouling Problems	References
		Dose	Condenser Outlet	Discharge Point				
1	1	~3	NA	<0.1 TRC	Condenser	Seawater	Yes	B1, B2
2	1	~7 (max)	NA	0.2-0.9 TRC	Condenser	Low TDS	No	B1, B2
3	Multiple	NA	2 FAC (max)	<DL	Unit	Low TDS	No	B1, B2
4	1	NA	<0.1 TRC	<0.1 TRC	None	Brackish	No	B1, B2
5	1	0.6	NA	<0.1 TRC	Condenser + Unit	Seawater	Yes	B1, B2
6	1	2.8 (max)	0.8-1 FAC	<0.1 TRC	Condenser + Unit	Seawater	No	B1, B2
7	1	NA	0.3-0.5 TRC	0.1 TRC	Condenser	Seawater	No	B1, B2
8	1	0	0	0	None	Low TDS	No	B1, B2
9	Multiple	NA	NA	0.1 FAC	Condenser + Unit	<500 ppm TDS	No	B1, B2
10	1	NA	NA	0.1 FAC	None	<500 ppm TDS	Yes	B1, B2
11	1	3.5	0.1-0.2 FAC	<0.1 TRC	Condenser + Unit	Low TDS	No	B1, B2
12	1	0.6-1	NA	0.1-0.2 FAC	None	Low TDS	No	B1, B2
13	1	0.5	NA	<0.1 TRC	Condenser	Brackish	Yes	B1, B2
14	Multiple	3.1	NA	0.2-0.8 TRC	Unit	NA	No	B1, B2
15	NA	NA	NA	0-0.2 TRC	NA	NA	No	B3
16	NA	NA	NA	0-0.2 TRC	NA	NA	No	B4
17	NA	NA	0.5 TRC	NA	NA	NA	No	B5
18	NA	NA	1.0 TRC	NA	NA	NA	No	B5
19	NA	NA	1.5 TRC	NA	NA	NA	No	B5
20	NA	NA	1.0 TRC	NA	NA	NA	No	B6
21	NA	NA	0.2 TRC	NA	NA	NA	No	B7
22	NA	NA	NA	>0.4 TRC	NA	NA	No	B8
23	NA	NA	NA	>0.2 TRC	NA	NA	No	B8
24	NA	NA	NA	>0.2 TRC	NA	NA	No	B9
25	NA	NA	NA	0.2 TRC	NA	NA	No	B10

\*<DL - Less than detection limit  
FAC - Free Available Chlorine  
TRC - Total Residual Chlorine  
NA - Not Available

could achieve compliance with the option. The percentage of plants that could achieve compliance under the option was then calculated by dividing the number of plants found to be able to achieve compliance by the total number of plants for which this information was available. The result of this calculation is that 63% of the plants in the data base are estimated to be able to comply with chlorine minimization.

APPENDIX D  
REFERENCES

1. Lehr, John, "Summary Report on Chlorination Practices and Controls at Operating U.S. Nuclear Power Plants," Draft Report, United States Nuclear Regulatory Commission, Washington, D.C., May 1978.
2. Hunton and Williams, "Comments of the Utility Water Act Group, etc. on the Environmental Protection Agency's October 14, 1980 Proposed Effluent Limitations and New Source Performance Standards for the Steam Electric Generating Point Source Category; Section III: The Proposed Limitations and Standards for Once-Through Cooling Tower Blowdown; Appendix III (F) Chlorination Practices of Nuclear Plants (UWAG, 1980)," Prepared by Hunton and Williams, 1919 Pennsylvania Avenue, N.W., Washington, D.C., January 19, 1981.
3. Bernt, D. S. and K. H. Nordstrom, "Chlorine Reduction Study: High Bridge Generating Plant," Northern States Power Company, Minneapolis, MN, June 1978.
4. Bernt, D. S., "Chlorine Reduction Study: Monticello Generating Plant," Northern States Power Company, Minneapolis, MN, June 1978.
5. Philadelphia Electric Company, "Condenser Chlorination Study - 1977/1978," Philadelphia, PA, October 1978.
6. Schumacher, P. D. and J. W. Lingle, "Chlorine Minimization Studies at the Valley and Oak Creek Power Plants," presented at the Condenser Biofouling Control Symposium, Atlanta, GA, March 1979.
7. Moss, Robert, et al., "Chlorine Minimization/Optimization at One TVA Steam Plant," Tennessee Valley Authority, Chattanooga, TN, 1978.
8. Commonwealth Edison, "Chlorine Reduction Studies," Chicago, IL, December 1976.
9. American Electric Power Service Corporation, "Indiana-Kentucky Electric Corporation, Clifty Creek Station: Chlorine Study Report," Vols. 1 and 2, Canton, OH, June 1978.
10. Duquesne Light Company, "Shippingport Atomic Power Station, NPDES Permit No. PA 0001589: Chlorine Reduction Study," Pittsburgh, PA, December 1978.