

Vapor Recovery and Gathering Pipeline Pigging



Lessons Learned from Natural Gas STAR

Chevron Corporation,
New Mexico Oil and Gas Association,
Texas Oil and Gas Association

Producers and Processors Technology
Transfer Workshop
Midland, Texas
July 23, 2008



epa.gov/gasstar

Reduction Opportunities: Agenda

- 🔥 Industry Emissions
- 🔥 Selected Methane Saving Opportunities
 - 🔥 Vapor Recovery Units
 - 🔥 Pipeline Pigging
- 🔥 Discussion

Industry Emissions: Production, Gathering, and Boosting

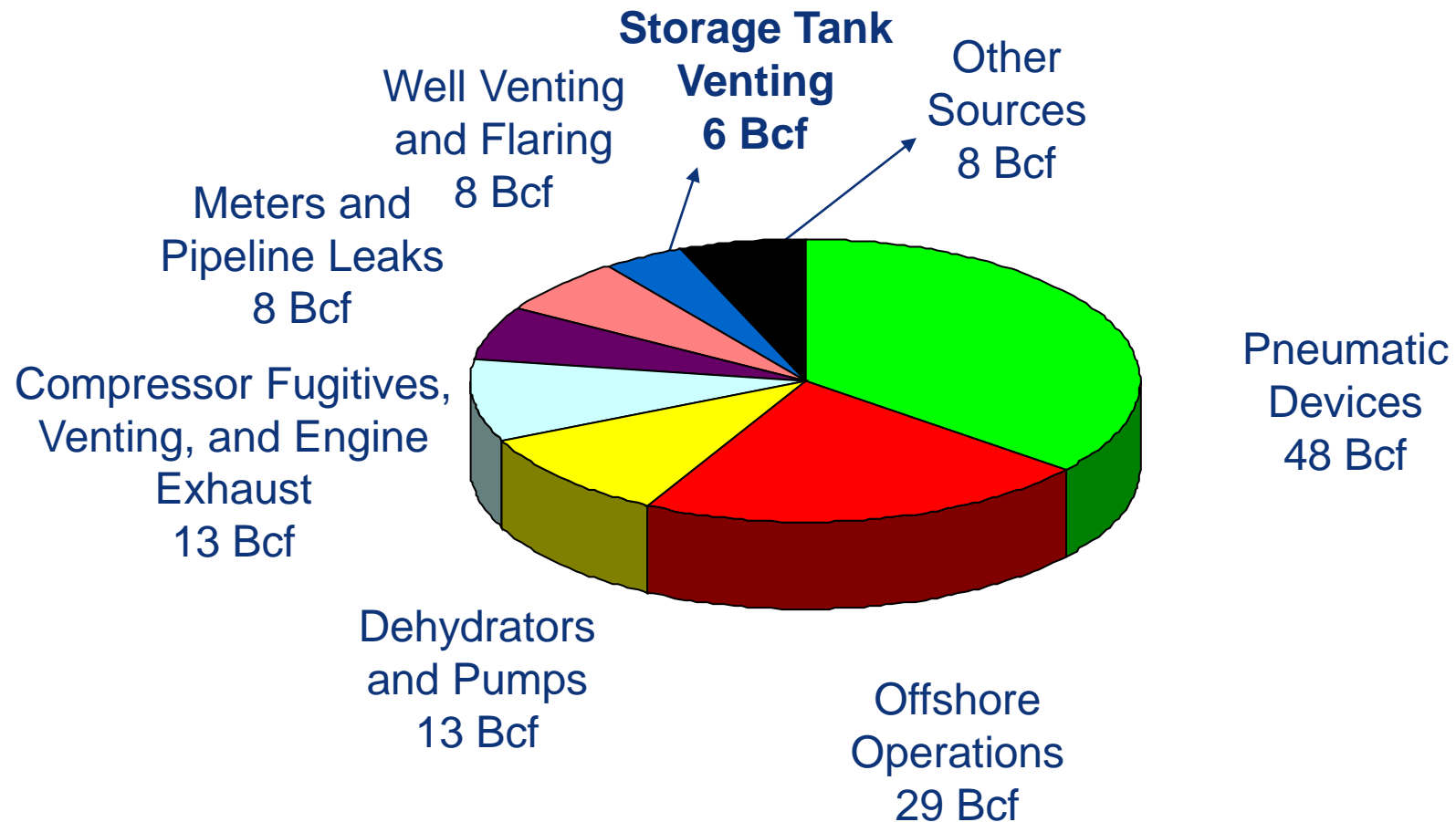

Source: EPA. *Inventory of U.S. Greenhouse Gas Emissions and Sinks 1990 – 2006*. April, 2008. Available on the web at: epa.gov/climatechange/emissions/usinventoryreport.html

Note: Natural Gas STAR reductions from gathering and boosting operations are reflected in the production sector.

Vapor Recovery Units

- 🔥 Methane Losses
- 🔥 Methane Savings
- 🔥 Is Recovery Profitable?
- 🔥 Industry Experience
- 🔥 Lessons Learned

Sources of Methane Losses

- 🔥 A storage tank battery can vent 5,000 to 500,000 thousand cubic feet (Mcf) of natural gas and light hydrocarbon vapors to the atmosphere each year
 - 🔥 Vapor losses are primarily a function of oil or condensate throughput, gravity, and gas-oil separator pressure
- 🔥 Flash losses
 - 🔥 Occur when crude oil or condensate is transferred from a gas-oil separator at higher pressure to a storage tank at atmospheric pressure
- 🔥 Working losses
 - 🔥 Occur when crude or condensate levels change and when liquid in tank is agitated
- 🔥 Standing losses
 - 🔥 Occur with daily and seasonal temperature and barometric pressure changes

Methane Savings: Vapor Recovery

- 🔥 Vapor recovery can capture up to 95% of hydrocarbon vapors from tanks
- 🔥 Recovered vapors have higher heat content than pipeline quality natural gas
- 🔥 Recovered vapors are more valuable than natural gas and have multiple uses
 - 🔥 Re-inject into sales pipeline
 - 🔥 Use as on-site fuel
 - 🔥 Send to processing plants for recovering valuable natural gas liquids

Types of Vapor Recovery Units

- 🔥 Conventional vapor recovery units (VRUs)
 - 🔥 Use screw or vane compressor to suck vapors out of atmospheric pressure storage tanks
 - 🔥 Scroll compressors are new to this market
 - 🔥 Require electrical power or engine driver
- 🔥 Venturi ejector vapor recovery units (EVRU™) or Vapor Jet
 - 🔥 Use Venturi jet ejectors in place of rotary compressors
 - 🔥 Contain no moving parts
 - 🔥 EVRU™ requires a source of high pressure motive gas and intermediate pressure discharge system
 - 🔥 Vapor Jet requires a high pressure water motive

Conventional Vapor Recovery Unit

Source: Evans & Nelson (1968)

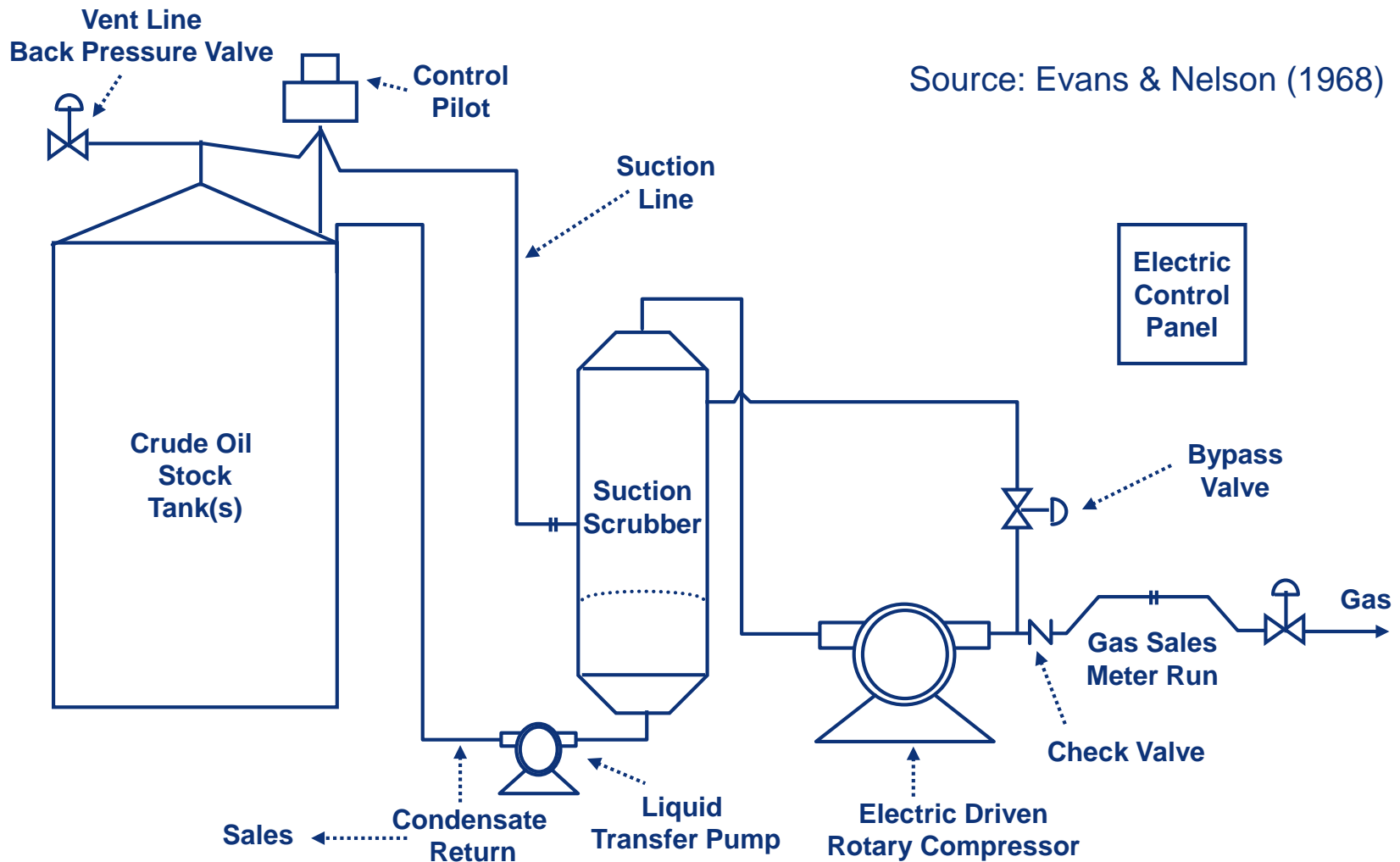

Vapor Recovery Installations



Venturi Jet Ejector*

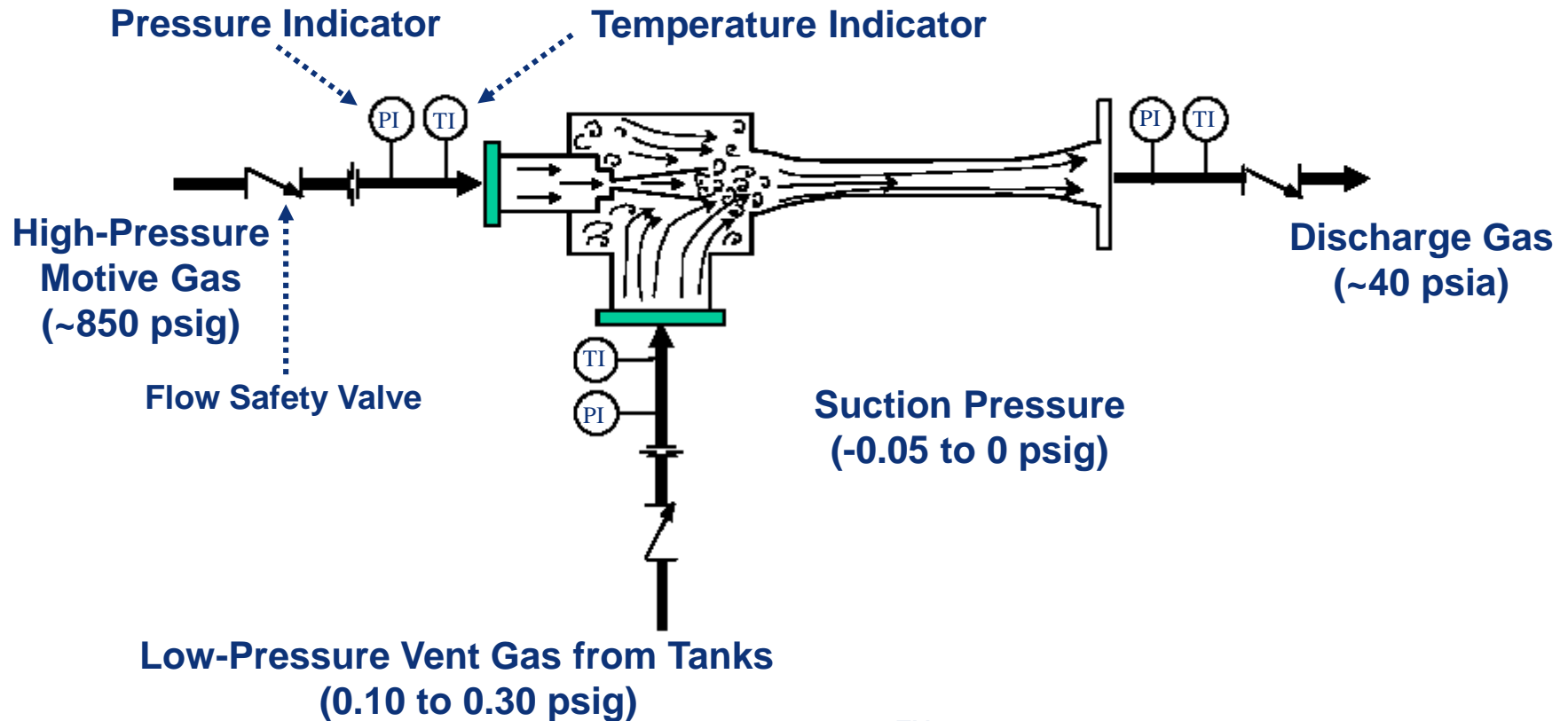

*EVRU™ Patented by COMM Engineering

Adapted from SRI/USEPA-GHG-VR-19

psig = pound per square inch, gauge

psia = pounds per square inch, absolute

Vapor Recovery with Ejector

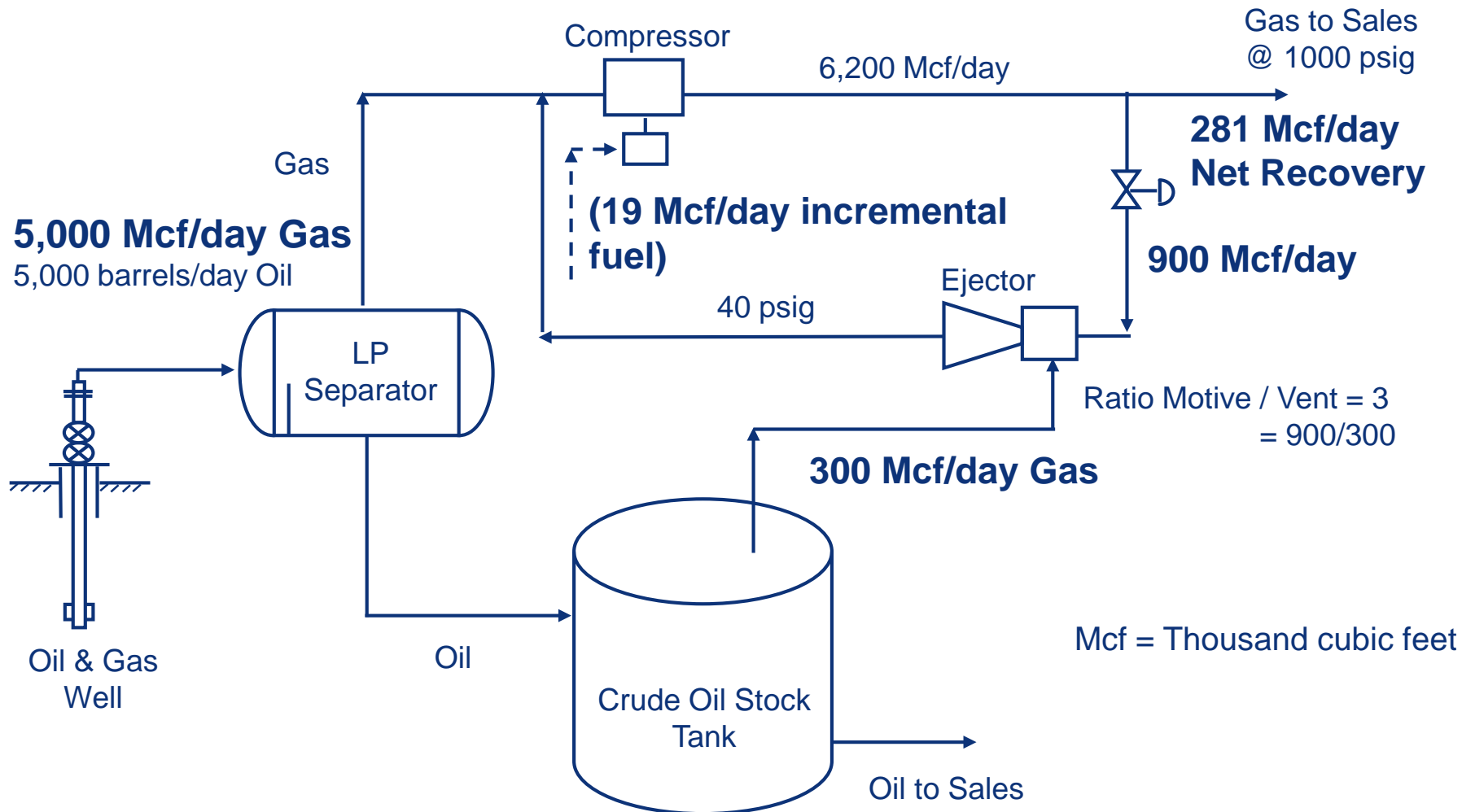

Vapor Jet System*

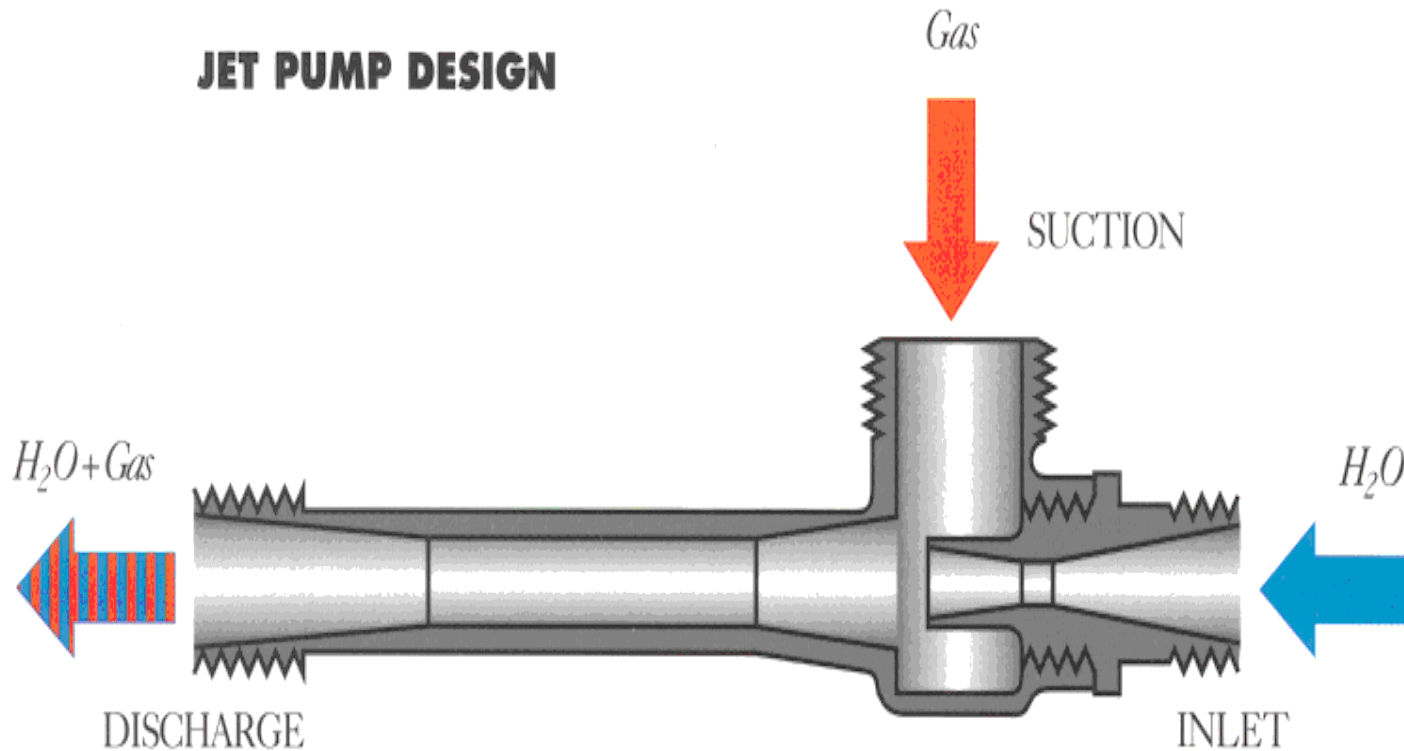

*Patented by Hy-Bon Engineering

Vapor Jet System*

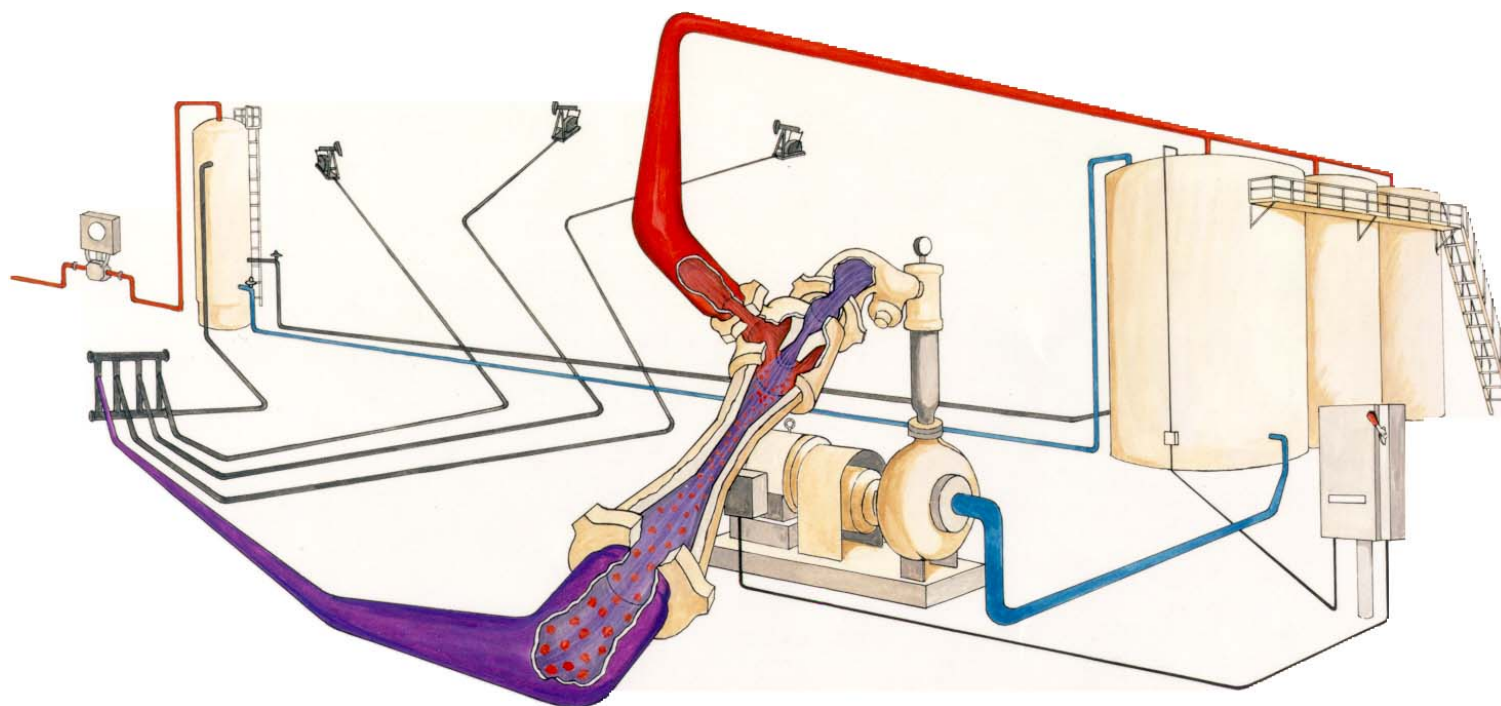

- Utilizes produced water in closed loop system to effect gas gathering from tanks
- Small centrifugal pump forces water into Venturi jet, creating vacuum effect
- Limited to gas volumes of 77 Mcf/day and discharge pressure of 40 psig

*Patented by Hy-Bon Engineering

Criteria for Vapor Recovery Unit Locations

- 🔥 Steady source and sufficient quantity of losses
 - 🔥 Crude oil stock tank
 - 🔥 Flash tank, heater/treater, water skimmer vents
 - 🔥 Gas pneumatic controllers and pumps
 - 🔥 Dehydrator still vent
 - 🔥 Pig trap vent
- 🔥 Outlet for recovered gas
 - 🔥 Access to low pressure gas pipeline, compressor suction, or on-site fuel system
- 🔥 Tank batteries not subject to air regulations

Quantify Volume of Losses

- 🔥 Estimate losses from chart based on oil characteristics, pressure, and temperature at each location ($\pm 50\%$)
- 🔥 Estimate emissions using the E&P Tank Model ($\pm 20\%$)
- 🔥 Engineering Equations – Vasquez Beggs ($\pm 20\%$)
- 🔥 Measure losses using recording manometer and well tester or ultrasonic meter over several cycles ($\pm 5\%$)
 - 🔥 This is the best approach for facility design

Estimated Volume of Tank Vapors

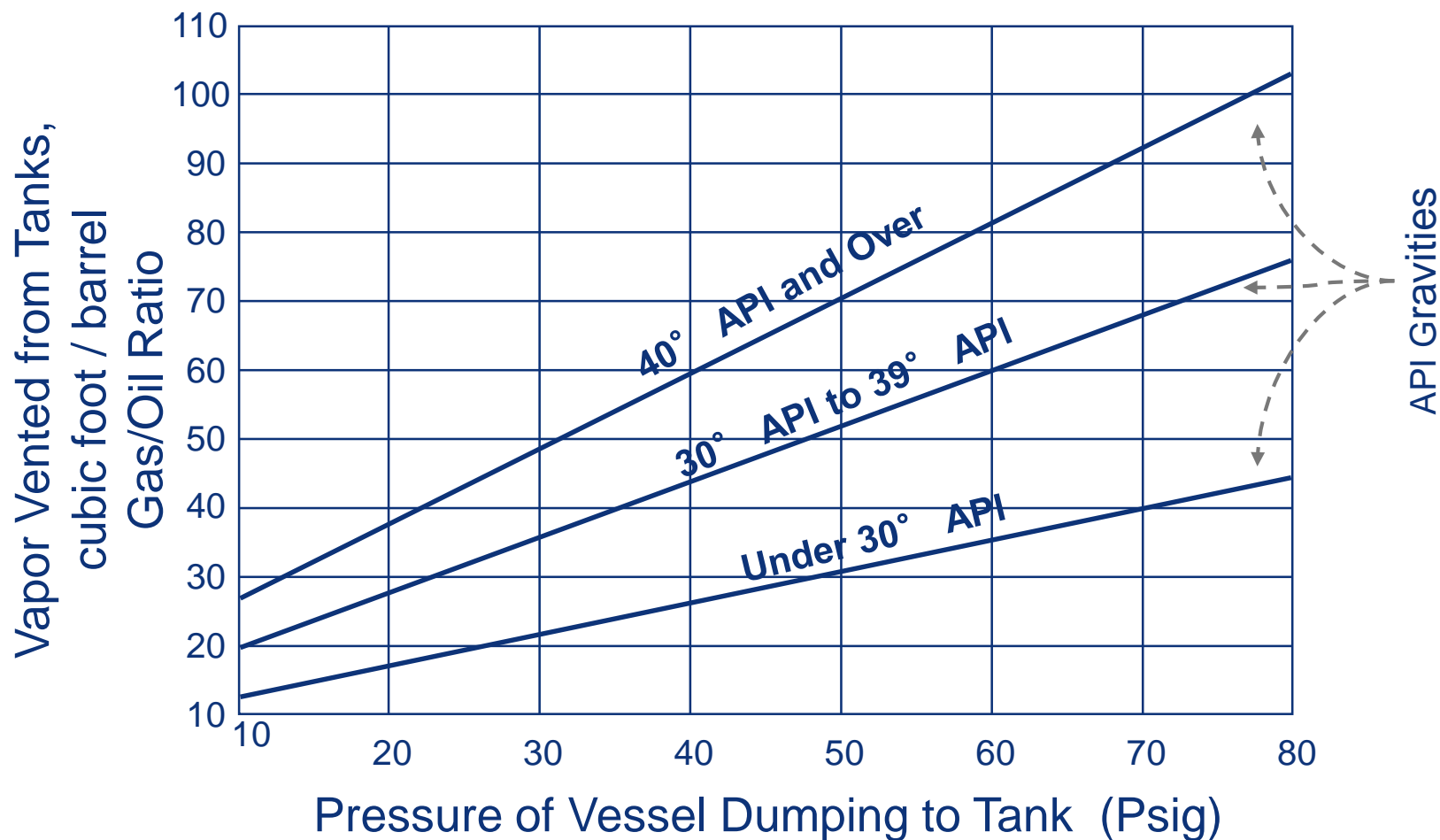

°API = API gravity

Estimated Volume of Tank Vapors

- Atmospheric tanks may emit large amounts of tank vapors at relatively low separator pressure

Vasquez-Beggs Equation

$$GOR = A \times (G_{\text{flash gas}}) \times (P_{\text{sep}} + 14.7)^B \times \exp\left(\frac{C \times G_{\text{oil}}}{T_{\text{sep}} + 460}\right)$$

where,

GOR	=	Ratio of flash gas production to standard stock tank barrels of oil produced, in scf/bbl oil (barrels of oil corrected to 60°F)
$G_{\text{flash gas}}$	=	Specific gravity of the tank flash gas, where air = 1. A suggested default value for $G_{\text{flash gas}}$ is 1.22 (TNRCC; Vasquez, 1980)
G_{oil}	=	API gravity of stock tank oil at 60°F
P_{sep}	=	Pressure in separator, in psig
T_{sep}	=	Temperature in separator, °F

For $G_{\text{oil}} \leq 30^\circ\text{API}$: A = 0.0362; B = 1.0937; and C = 25.724

For $G_{\text{oil}} > 30^\circ\text{API}$: A = 0.0178; B = 1.187; and C = 23.931

psig – pounds per square inch, gauge
 scf – standard cubic feet
 bbl – barrels

What is the Recovered Gas Worth?

- 🔥 Value depends on heat content of gas
- 🔥 Value depends on how gas is used
 - 🔥 On-site fuel
 - 🔥 Valued in terms of fuel that is replaced
 - 🔥 Natural gas pipeline
 - 🔥 Measured by the higher price for rich (higher heat content) gas
 - 🔥 Gas processing plant
 - 🔥 Measured by value of natural gas liquids and methane, which can be separated
- 🔥 Gross revenue per year = $(Q \times P \times 365) + \text{NGL}$
 - 🔥 Q = Rate of vapor recovery (Mcf per day)
 - 🔥 P = Price of natural gas
 - 🔥 NGL = Value of natural gas liquids

Value of Natural Gas Liquids

	1 Btu/gallon	2 MMBtu/ gallon	3 \$/gallon	4 \$/MMBtu ^{1,2} (=3/2)
Methane	59,755	0.06	0.43	7.15
Ethane	74,010	0.07	1.51	21.57
Propane	91,740	0.09	1.99	22.11
n Butane	103,787	0.10	2.48	24.80
iso Butane	100,176	0.10	2.49	24.90
Pentanes+*	105,000	0.11	3.08	28.00

	5 Btu/cf	6 MMBtu/Mcf	7 \$/Mcf (=4*6)	8 \$/MMBtu	9 Vapor Composition	10 Mixture (MMBtu/Mcf)	11 Value (\$/Mcf) (=8*10)
Methane	1,012	1.01	\$7.22	7.15	82%	0.83	\$5.93
Ethane	1,773	1.77	\$38.18	21.57	8%	0.14	\$3.05
Propane	2,524	2.52	\$55.71	22.11	4%	0.10	\$2.23
n Butane	3,271	3.27	\$81.09	24.80	3%	0.10	\$2.43
iso Butane	3,261	3.26	\$80.90	24.90	1%	0.03	\$0.81
Pentanes+	4,380	4.38	\$122.64	28.00	2%	0.09	\$2.45
Total						1.289	\$16.90

1 – Natural Gas Price assumed at \$7.15/MMBtu as on Mar 16, 2006 at Henry Hub

2 – Prices of Individual NGL components are from Platts Oilgram for Mont Belvieu, TX July 11, 2008

Cost of a Conventional VRU

Vapor Recovery Unit Sizes and Costs				
Capacity (Mcf/day)	Compressor Horsepower	Capital Costs (\$)	Installation Costs (\$)	O&M Costs (\$/year)
25	5 to 10	20,421	10,207 to 20,421	7,367
50	10 to 15	26,327	13,164 to 26,327	8,419
100	15 to 25	31,728	15,864 to 31,728	10,103
200	30 to 50	42,529	21,264 to 42,529	11,787
500	60 to 80	59,405	29,703 to 59,405	16,839

Cost information provided by United States Natural Gas STAR companies and VRU manufacturers, 2006 basis.

Is Recovery Profitable?

Financial Analysis for a Conventional VRU Project

Peak Capacity (Mcf/day)	Installation & Capital Costs ¹ (\$)	O&M Costs (\$/year)	Value of Gas ² (\$/year)	Annual Savings (\$)	Simple Payback (months)	Internal Rate of Return
25	\$35,738	\$7,367	\$77,106	\$69,739	10	121%
50	\$46,073	\$8,419	\$154,213	\$145,794	6	204%
100	\$55,524	\$10,103	\$308,425	\$298,322	4	352%
200	\$74,425	\$11,787	\$616,850	\$605,063	3	537%
500	\$103,959	\$16,839	\$1,542,125	\$1,525,286	2	974%

1 – Unit cost plus estimated installation of 75% of unit cost

2 – \$16.90 x ½ peak capacity x 365, Assumed price includes Btu enriched gas (1.289 MMBtu/Mcf)

Industry Experience: EnCana Oil & Gas

- 🔥 Vapor recovery unit installed in Frenchie Draw, WY
- 🔥 Captures vapors from
 - 🔥 Separators
 - 🔥 Crude oil storage tank
 - 🔥 Non-condensable dehydrator still gas
- 🔥 VRU designed to handle 500 Mcf/day
 - 🔥 Additional capacity over the estimated 284 Mcf/day of total gas from all emission sources

Industry Experience: EnCana Oil & Gas

🔥 Quantify the volume of vapor emissions

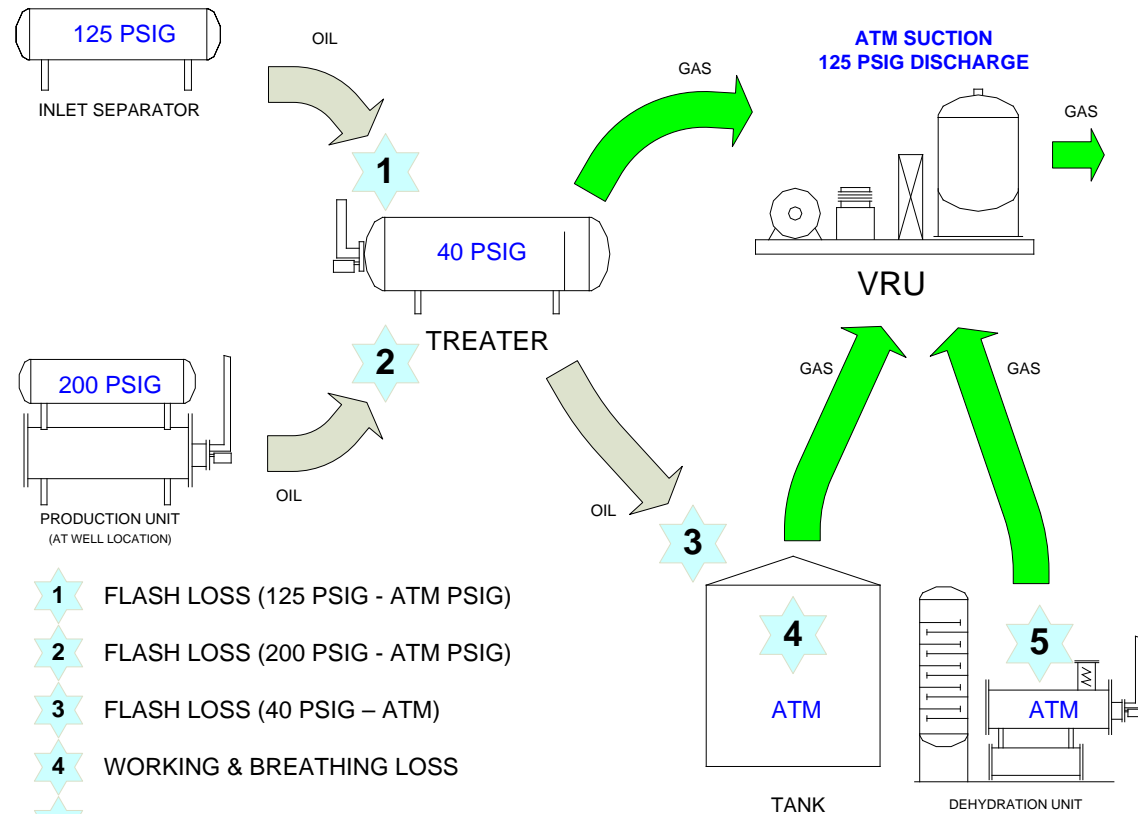

**Total Emissions-
284 MSCFD**

- 1 FLASH LOSS (125 PSIG - ATM PSIG)
- 2 FLASH LOSS (200 PSIG - ATM PSIG)
- 3 FLASH LOSS (40 PSIG - ATM)
- 4 WORKING & BREATHING LOSS
- 5 STILL VENT NON CONDENSIBLE

Source: EnCana Oil & Gas (USA) Inc.

EnCana Oil & Gas: Project Costs

🔥 Determine the cost of VRU project

Installation

VRU Unit (500 Mcfd) -	\$90,000
Generator-	\$85,000
Vent Header-	\$25,000
Labor-	<u>\$200,000</u>
TOTAL	\$400,000

O & M

VRU Unit (500 Mcfd) -	\$15,000
Generator-	\$18,000
Fuel-	<u>\$73,000</u>
TOTAL	\$106,000

EnCana Oil & Gas: Project Economics

🔥 Evaluate VRU economics

Capacity–	500 Mcfd
Installation Cost -	\$400,000
O&M-	\$106,000/year
Value of Gas*-	\$788,400/year
Payback-	7 months
Return on Investment-	170%

*Gas price assumed to be \$ 7.60 by Encana

Industry Experience: Anadarko

🔥 Vapor Recover Tower (VRT)

- 🔥 Add separation vessel between heater treater or low pressure separator and storage tanks that operates at or near atmospheric pressure
 - 🔥 Operating pressure range: 1 psi to 5 psi
- 🔥 Compressor (VRU) is used to capture gas from VRT
- 🔥 Oil/Condensate gravity flows from VRT to storage tanks
 - 🔥 VRT insulates the VRU from gas surges with stock tank level changes
 - 🔥 VRT more tolerant to higher and lower pressures
 - 🔥 Stable pressure allows better operating factor for VRU

Industry Experience: Anadarko

- 🔥 VRT reduces pressure drop from approximately 50 psig to 1-5 psig
 - 🔥 Reduces flashing losses
 - 🔥 Captures more product for sales
 - 🔥 Anadarko netted between \$7 to \$8 million from 1993 to 1999 by utilizing VRT/VRU configuration
- 🔥 Equipment Capital Cost: \$11,000
- 🔥 Standard size VRTs available based on oil production rate
 - 🔥 20" x 35'
 - 🔥 48" x 35'
- 🔥 Anadarko has installed over 300 VRT/VRUs since 1993 and continues on an as needed basis

VRT/VRU Photos



Courtesy of Anadarko

Lessons Learned

- 🔥 Vapor recovery can yield generous returns when there are market outlets for recovered gas
 - 🔥 Recovered high heat content gas has extra value
 - 🔥 Vapor recovery technology can be highly cost-effective in most general applications
 - 🔥 Venturi jet models work well in certain niche applications, with reduced operating and maintenance costs
- 🔥 Potential for reduced compliance costs can be considered when evaluating economics of VRU, EVRU™, or Vapor Jet

Lessons Learned (continued)

- 🔥 VRU should be sized for maximum volume expected from storage tanks (rule-of-thumb is to double daily average volume)
- 🔥 Rotary vane, screw or scroll type compressors recommended for VRUs where Venturi ejector jet designs are not applicable
- 🔥 EVRU™ recommended where there is a high pressure gas compressor with excess capacity
- 🔥 Vapor Jet recommended where there is produced water, less than 75 Mcf per day gas and discharge pressures below 40 psig

Methane Losses from Pipeline Pigging

- 🔥 Gas lost when launching and receiving a pig
- 🔥 Fugitive emissions from pig launcher/receiver valves
- 🔥 Gas lost from storage tanks receiving condensate removed by pigging
- 🔥 Gas vented from pipeline blowdowns

Pigging Pipelines

- Hydrocarbons and water condense inside pipelines, causing pressure drop and reducing gas flow
- Periodic line pigging removes liquids and debris to improve gas flow
 - Also inspect pipeline integrity
- Efficient pigging:
 - Keeps pipeline running continuously
 - Keeps pipeline near maximum throughput by removing debris
 - Minimizes product losses during launch/capture



Source: www.girardind.com/

How Does Pigging Vent Methane?

- 🔥 Pig launchers have isolation valves for loading pigs, pressurizing pigs, and launching pigs with gas bypassed from the pipeline
- 🔥 Launcher pressurizing/depressuring loses methane out the vent valve

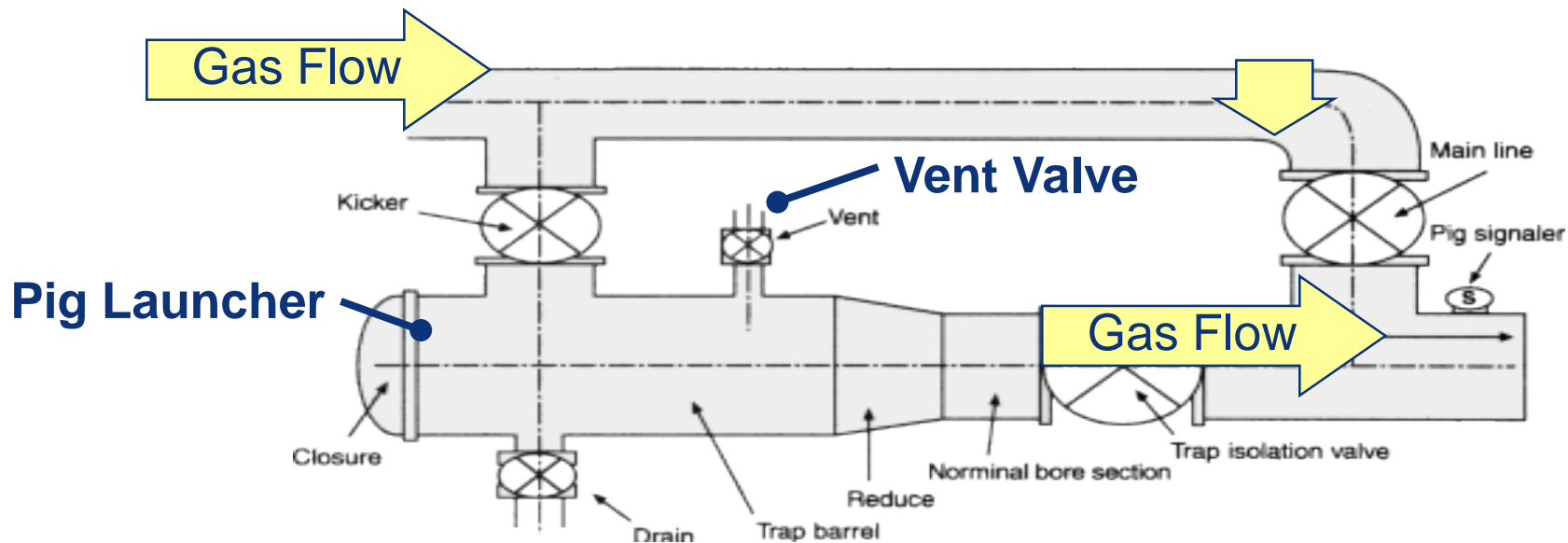

Source: www.girardind.com/

Pigging Vents Methane Twice

- 🔥 Methane lost through vent valve on the launcher and again through vent valve on the receiver
 - 🔥 Once receiver is isolated from the line, it must be depressured to remove the pig
 - 🔥 Liquids ahead of the pig drain to a vessel or tank
- 🔥 MORE than twice: isolation valve leaks may cause excessive venting to depressure

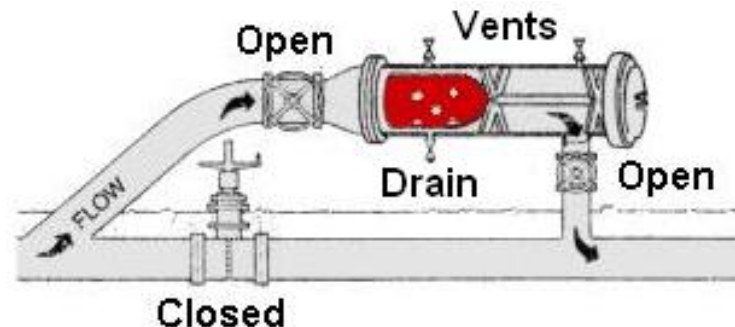

Source: www.girardind.com/

Methane Recovery

- 🔥 Pipeline maintenance requires pipe section blowdown before work can begin
- 🔥 Gas in pipeline is usually vented to the atmosphere
- 🔥 Use inert gas and pig
- 🔥 Route vent to vapor recovery system or fuel gas
 - 🔥 One Partner reported connecting pig receiver vent to fuel gas to recover gas while working a tight isolation

Is Recovery Profitable?

- 🔥 One partner pigged gathering lines 30 to 40 times per year, collecting several thousand barrels of condensate per application
- 🔥 Partner reported saving 21,400 Mcf/year from recovering flash gases
- 🔥 Dedicated vapor recovery unit (VRU) was installed with an electric compressor at an installation cost of \$24,000 and an annual operating cost of \$40,000 mostly for electricity
- 🔥 Large gas savings and increasing gas prices will offset costs

Gas Price (\$/Mcf)	\$7.00
Gas Saved (Mcf/year)	21,400
Annual Savings (\$/year)	\$149,800
Installed Cost	\$24,000
Operating Cost	\$40,000
Payback Period (years)	0.3

Discussion

- 🔥 Industry experience applying these technologies and practices
- 🔥 Limitations on application of these technologies and practices
- 🔥 Actual costs and benefits