



REMVue™ Energy Optimization with SlipStream™



REMVue® Energy Optimization with SlipStream™

Todd Gilbertson
EngineWorx LLC

Gas STAR Program May 6, 2008



REMVue™ Energy Optimization with SlipStream™



Relevant Star Partner Topics

- Efficiency
- Diagnostics
- SlipStream™
 - Using fugitive emissions as fuel
- Challenges



REMVue™ Energy Optimization with SlipStream™



EngineWorx Overview

- EngineWorx — a services company and wholly-owned subsidiary of John H. Carter
 - North American Representative: REM Technology
 - EngineWorx has installed 100+ REMVue® systems in Texas, Louisiana, Florida, Colorado, Alabama, Mississippi and the Gulf of Mexico
 - 7/24 Customer Service
- John H. Carter Co., Inc. established in 1933
 - Emerson Representative for US Gulf Coast
 - DCS systems
 - Asset Optimization and Management
 - 250 Employee Owners
 - Support Offices: New Orleans, Baton Rouge, Lafayette, Lake Charles, Monroe and Mobile



REMVue™ Energy Optimization with SlipStream™



REM Technology

- REM Technology Inc. provides technology solutions for engines and compressors
- Parent Company is Spartan Controls of Calgary, AB. Forty-five years in business and 600 employee owners.
- Focused on technology development applied to reciprocating engines for better efficiency, reliability and emissions (regulated and GHG)
- REMVue® solutions reside in an integrated Engine/Compressor Control Platform with:
 - **Combustion Management**
 - Rich to Lean Conversions
 - Lean Burn
 - Stoichiometric with Catalyst
 - Low Horsepower - LHP
 - Safety Shutdown
 - Process/Unit Control
 - Diagnostics
 - Key Asset Performance and Health Indicators
 - **Advanced Applications – SlipStream™**

RESULTS

- **Fuel Savings**
 - 102 mcf/d at 97% runtime
 - 36 mmbtu/year at \$8/mbtu
 - **\$289,000 revenue/year** (much more if used for Gas Lift)
- **Green House Gas Reduction**
 - 12,000 t/yr CO₂(e) for offset or trade
 - Potential trading values of \$5 - \$15 per tonne
 - **\$120,000 year at \$5/t**

Ideal Installations

- Highspeed, Turbocharged Engine such as a Waukesha 7042GSI
- Running at Stoichiometric – i.e. Rich Burning
- Located on a structure with pipeline pumps, oil and/or gas dehydration, water treatment, a flare or with other sources of vented gases and fugitive emissions

Relevant Star Partner Topics

- Efficiency
 - Combustion Management
 - Rich to Lean Engine Conversion
 - Improving thermal efficiency
 - Compressor Capacity Control
 - Unit Cooling Control
- Diagnostics
 - Key Asset Performance and Health Indicators
 - Unit Efficiency “Gas Mileage”
 - Compressor Leaks
- SlipStream™
 - Using fugitive emissions as fuel
- Challenges

AFR - Operating Zones

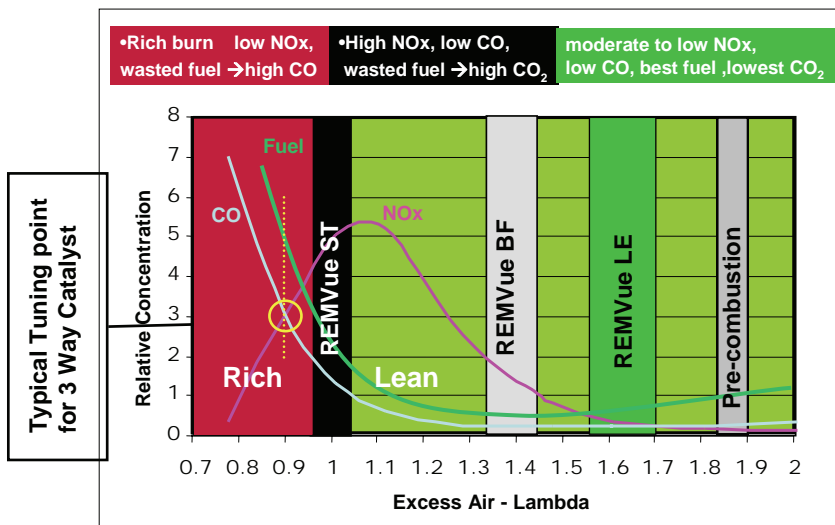

Adaptive Control

Operation in these zones is enabled by robust, adaptive control of the engine.

- Integrated AFR, Governor and Emissions Control
- Automatic Real-Time Compensation for:
 - Ambient Air Temperature
 - Load changes
 - Fuel BTU changes
 - Intercooler and Turbo performance degradation
- Multiple Adjustable Curves for Dynamic Adaptive Control
- Ignition Control and Integration
 - Advance or Retard ignition as conditions allow to maximize efficiency and minimize risk of detonation

REMVue - Rich to Lean Conversion*

- Provides improved thermal efficiency
 - Less unburned fuel, less CO emissions
 - Less heat loss from burned gases
 - No 3-way exhaust catalyst requiring energy
- Reduces fuel consumption
- Reduces greenhouse gases
 - Less fuel used
 - Less methane in exhaust gases
- Meets regulated offshore emission requirements
- Reliability improvement
 - Lower temperature operation i.e. lower peak burn temperatures and pressures
 - Tighter, **more stable** engine control
 - Lower occurrence of detonation
 - **Significant reduction in head failures**
- Improves engines “range” of operation (available horsepower)
- Verified by third party study – Accurata/PTAC
 - <http://www.ptac.org/eet/dl/eetf0501p06.pdf>

*A high fraction of existing NG engines in the oil and gas industry are “rich burn”.

PTAC – Petroleum Technology Alliance Canada

Typical REMVue Modifications

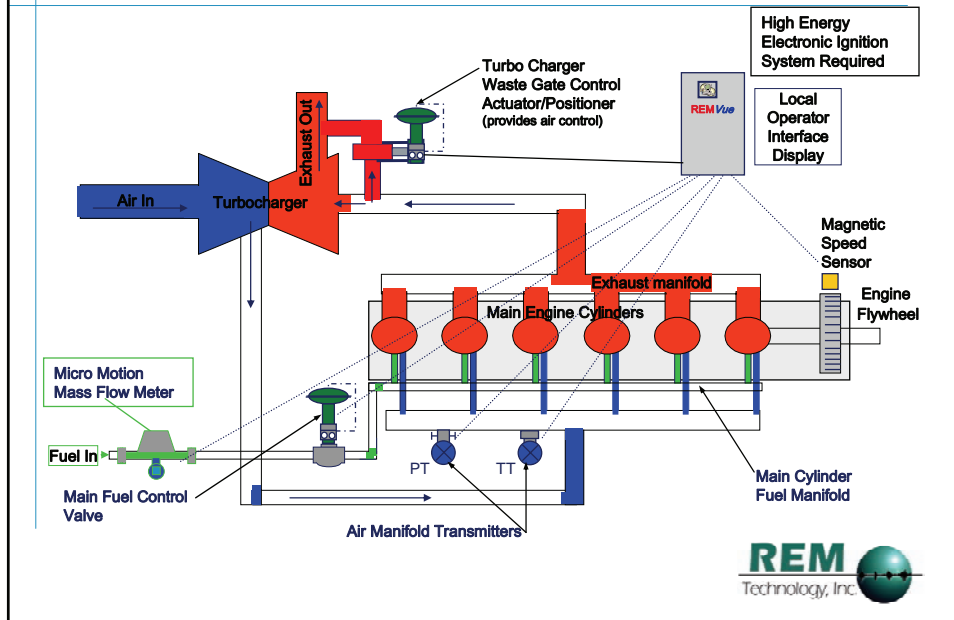

EngineWorx

REMVue™ Energy Optimization with SlipStream™

REM Technology, Inc.

Reduced Exhaust Temperatures

- Reduced valve failure
- Reduced head damage
- Reduced oil wear metals

Exhaust Temperature -
Waukesha 9390

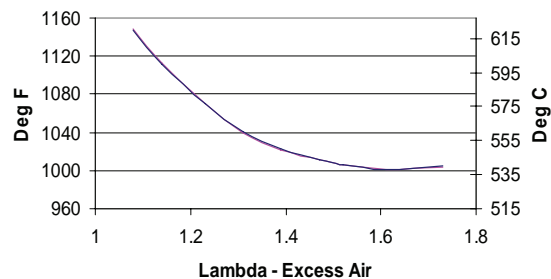

Turbo Temperature

BEFORE

Delta 210 °F

AFTER

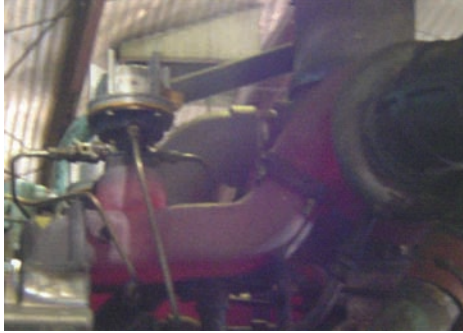

- Chevron's compressor optimization fleet plan
 - 100 REMVue® AFR installations
- Realized annual fuel savings in excess of \$15 million!

".....The increase in production from reliability and efficiencies will far exceed the fuel savings."

Robert E. Ingraham Jr.
Hatters Pond & Chunchula Plants
Senior Process Engineer

Initial installation of the 100 systems cost Chevron around \$13 Million. The \$15 million in fuel savings is annual, year after year, after year These systems have been installed since 2002, making the total ROI to date well in excess of \$75 million.

Compression Optimization

- Control asset to minimize energy waste
 - Minimize recycling
 - Minimize suction throttling
 - Minimize blow downs
 - Cooling fan speed/pitch control
 - Minimizes horsepower losses to parasitic load
 - Minimize liquid/flash gas recycling
- Engine loading
 - High % load (100% vs. 50%) gives up to **18% more efficiency**
- Recip Compressor RPM
 - Lower RPM (750 vs. 1200 RPM) can give **19% more efficiency** (less valve loss)

REMVue Diagnostics

- Provides a well/unhealthy indicator
- On-line 24/7 monitoring
- If well, no action is required;
- If unhealthy, provides an indicator of the problem type;
- If serious, provides alarms or shutdowns;
- Can provide an operating (**Opportunity**) cost of the problem.

Prompt correction of a problem
Can save fuel and avoid lost production

REMVue Diagnostics BSFC

Real-time Graph on engine HMI

The line shows expected performance;

The yellow dot shows current performance

BSFC “Gas Mileage”

On the line = OK

Off the line = problem

Engine or compressor not healthy

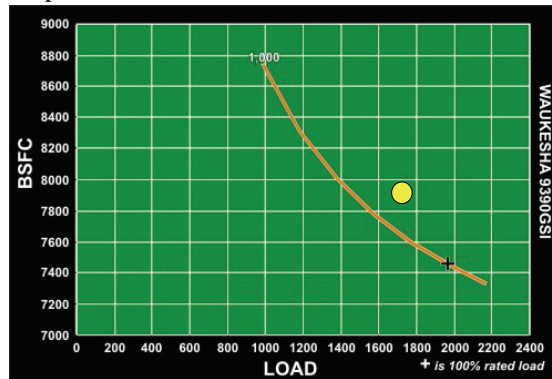

Brake Specific Fuel Consumption (BSFC) is the fuel heat per hour to generate 1 HP of mechanical power; a low BSFC means high fuel efficiency

REMVue Leak Diagnostics

Real-time Graph on engine HMI

A compressor leak causes lower compressor through-put and wasted engine fuel

- Compressor leak detection
 - Valve leak
 - Packing leak
 - Ring leak
 - Unloader leak
- Lost production estimate is \$2,443

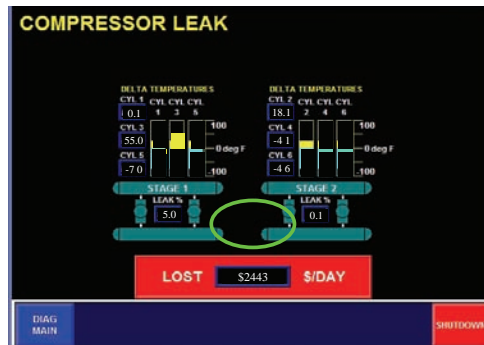



REMVue® SlipStream™

Getting a free boost!

* Patents Pending

SlipStream™

- SlipStream™ is the REM Technology product designed for utilizing *vented hydrocarbons* as a supplementary fuel source for natural gas engines
 - Vented HC gas into engine intake
 - Can be diluted with air or undiluted
 - Suitable for carbureted engines
 - Does not require vented gas compression - VRU
 - Vented fuel that is recovered can be considered “free”
 - Using SlipStream™, up to 50% of engine fuel can come from the vented sources
 - Substantial GHG(e) reduction
 - Advanced control allows for variability of Fugitives
 - Can burn BTEX+ (> 99.5% reduction)

Design Requirements for SlipStream™

- Develop a technology that would allow vented hydrocarbons to be used as supplementary fuel for natural gas engines
- Must be safe — *Safety First*
- Must not reduce performance or reliability of engine
- Must be scalable from low volumes of supplementary fuel to high volumes
- Must be able to compensate (*Air-Fuel Ratio and Governor*) for variable flow and BTU value of the supplementary fuel through the REMVue Combustion Management System

The Opportunity!

Potential Savings!!

- Venting (\$ 40 Million)
- Reciprocating Engines (\$ 220 Million)
- Heaters & Boilers (\$180 Million)
- Flaring & Incineration (\$ 60 Million)
- Fugitive Emissions Leaks (\$20 Million)
- Value of gas recovered based on 12% improvement

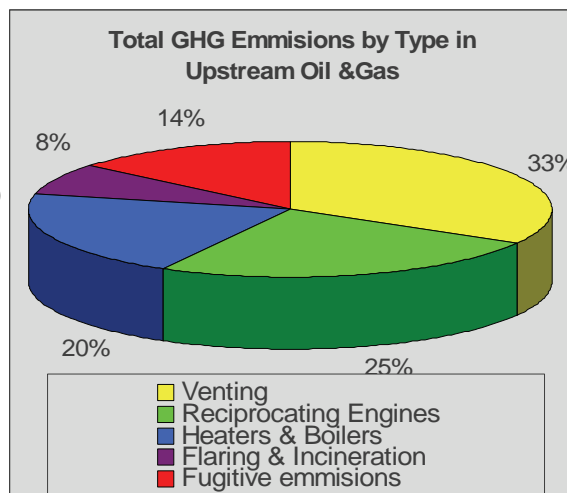

(from BP presentation Feb 05)

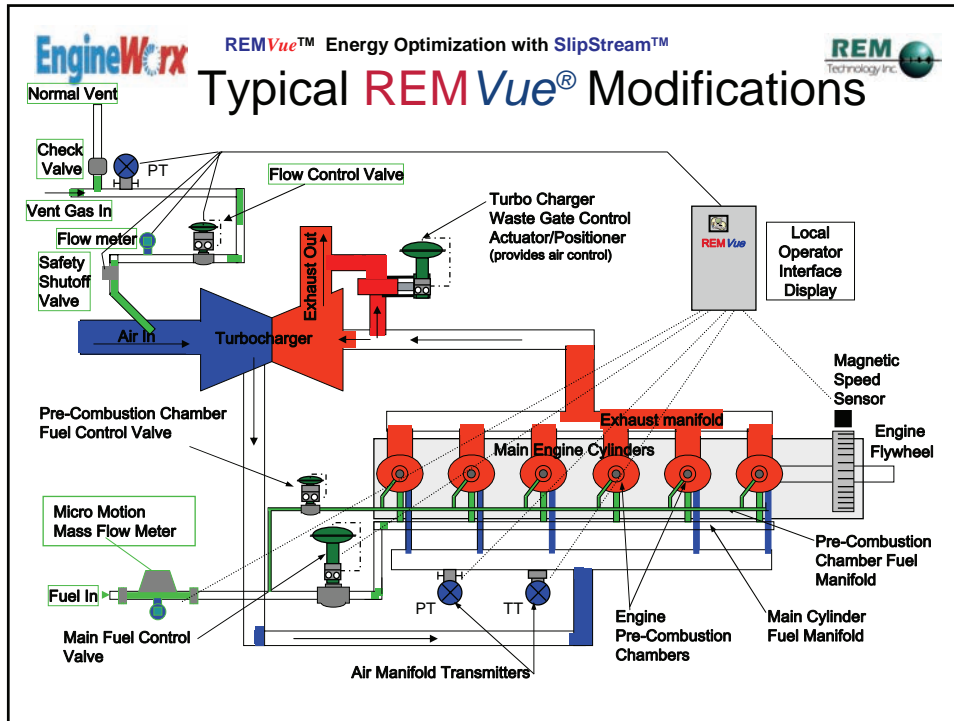

- EngineWorx REMVue™ Energy Optimization with SlipStream™
- REM Technology Inc.
- ## Offshore Fugitive Sources
- Major Sources – Blanketed Vessels
 - Surge Tanks
 - Chem-Electrics
 - Reboilers
 - Water treatment units
 - Minor Sources
 - Instrument gas vents
 - Compressor packing leaks
 - I/Ps and pneumatic devices
 - Engine starting, purging, blow-downs
 - Crankcases

Offshore Specific Implementation Issues

- Air Intake configurations varied
- Vent pipe routing/expense
- Panel vent devices typically not run to a common manifold exiting the panel
- Field Instruments vent locally

Control

- SlipStream™ uses advanced feed forward control algorithms proven with hundreds of R-L conversions to anticipate changes in SlipStream™ fuel flow and adjust the governor and air control accordingly
- The result — no impact to engine reliability or speed from:
 - Load changes
 - SlipStream™ Flow
 - Fuel gas or SlipStream™ gas BTU swings
 - Ambient temperature

SlipStream™ Results

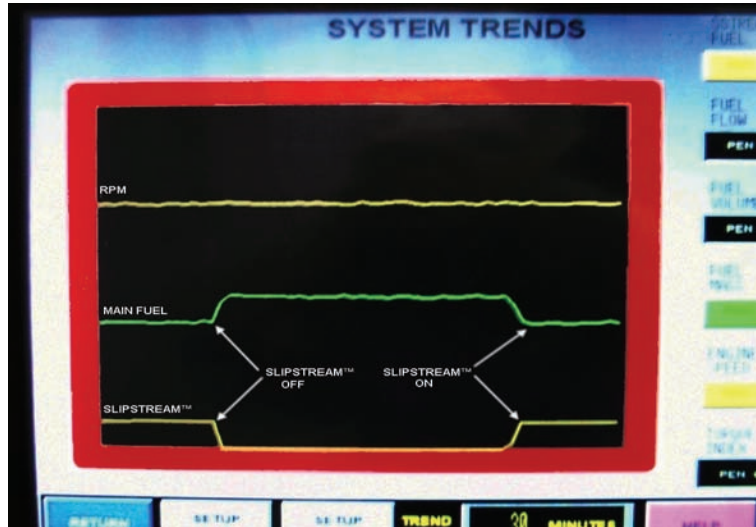

Real-time Graph on REMVue® HMI

SlipStream Technology*

- Level 1 < 10% of engine fuel
- Level 2 < 30% of engine fuel
- Level 3 < 50% of engine fuel

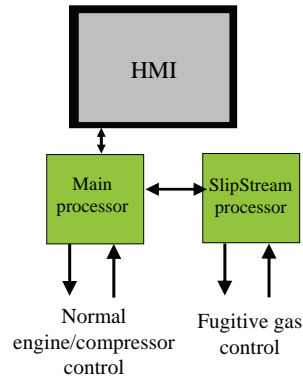

Level 3 SlipStream

* Patents Pending

Challenges

- Fuel cost accounting
 - Important but not urgent
 - Perceived as small cost relative to production
 - “The fuel doesn’t appear on my books.”
- Industry adoption of fuel efficiency is sporadic
 - Where are gas prices going?

Moving from an island solution to integrated solutions

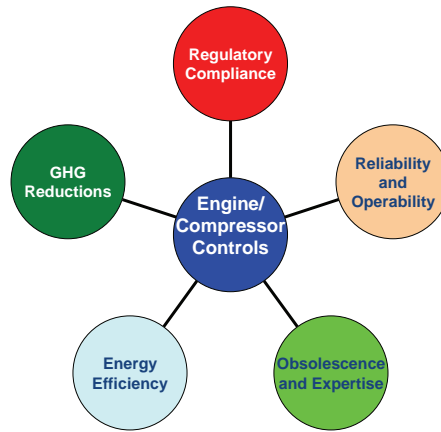

Fuel Savings and Emission Reductions

- **REMVue® R-L conversion** 260mcf – 20% = **52 mcf**
- **Slipstream (Up to 50% of Fuel)** **50 mcf**
 - Vented Gases from Instrumentation: 5-10 mcf 5 mcf
 - Compressor Packing Leaks: 5-15 mcf 10 mcf
 - Flares and LP, Blanketed Vessels: 10-104 mcf 35 mcf
 - Pipeline Pump Surge Tanks, Dehydration Units, Wemco's, Chem-Electrics, Etc.
- **Total Fuel Savings** = **102 mcf**
- **Total GHG Reductions** = **12,000 tonnes/yr CO2(e)**

RESULTS

- **Fuel Savings**
 - 102 mcf/d at 97% runtime
 - 36 mmbtu/year at \$8/mbtu
 - \$289,000 /year (much more if used for Gas Lift)
- **Green House Gas Reduction**
 - 12,000 t/yr CO₂(e) for offset or trade
 - Potential trading values of \$5 - \$15 per tonne
 - \$120,000 year at \$5/t

Ideal Installations

- Highspeed, Turbocharged Engine such as a Waukesha 7042GSI
- Running at Stoichiometric – i.e. Rich Burning
- Located on a structure with pipeline pumps, oil and/or gas dehydration, water treatment, a flare or with other sources of vented gases and fugitive emissions



REMVue™ Energy Optimization with SlipStream™



Thank You!