



WCXTM WORLD CONGRESS EXPERIENCE

APRIL 10-12, 2018 • COBO CENTER • DETROIT, MICHIGAN

sae.org/wcx

Constructing Engine Maps for Full Vehicle Simulation Modeling

Dekraker, P., Barba, D., Moskalik, A., and Butters, K., "Constructing Engine Maps for Full Vehicle Simulation Modeling," SAE Technical Paper 2018-01-1412, 2018, <https://doi.org/10.4271/2018-01-1412>.



EPA is tasked with assessing the effectiveness of new automotive technologies in meeting current and future GHG standards

Well Documented Engine and Vehicle Data are Necessary to:

- Assess the effectiveness of new automotive technologies
- Accelerate development and refinement of new technologies
- Examine behavior in real world operation

Vehicle Benchmarking

Validation Modeling

Engine Benchmarking

Fleet Level Modeling

Literature Review

Demonstration Projects

Validation vs Fleet Level Modeling

Validation Model

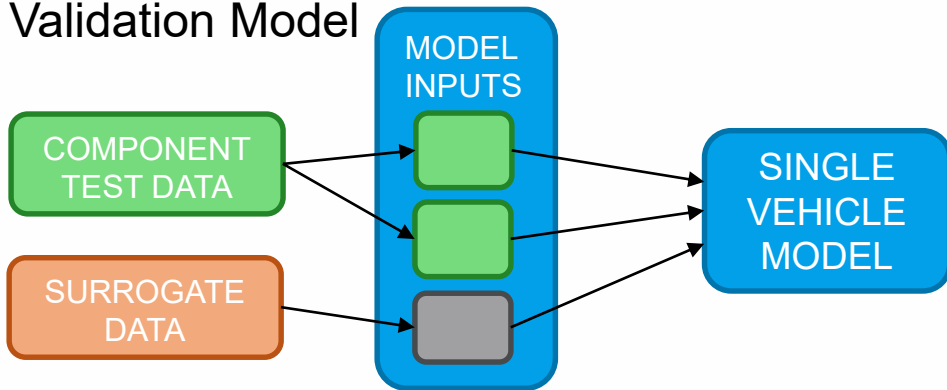

Examine Phase & Time Series Data
Ensure Losses are Characterized

Fleet Modeling

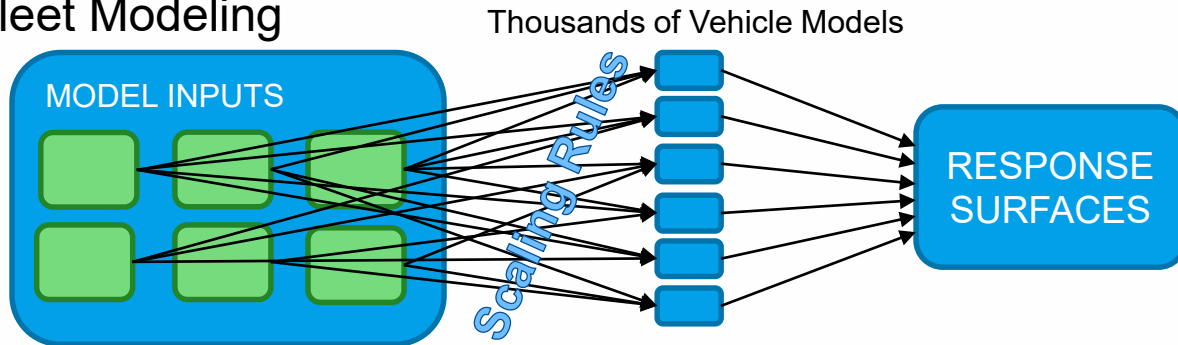

Examine / Predict Effectiveness of New Technologies

Constructing Engine Maps

This Paper & Presentation Describe the Important Factors & Approach for Constructing Engine Maps Which:

- Translate component data consistently into model inputs
- Produce an accurate characterization of the fleet
- Characterize the effectiveness of technology improvements across the fleet
- Ensure technologies are evaluated equitably

EPA's Advanced Light-Duty Powertrain & Hybrid Analysis (ALPHA) Tool Physics Based Full Vehicle Simulation

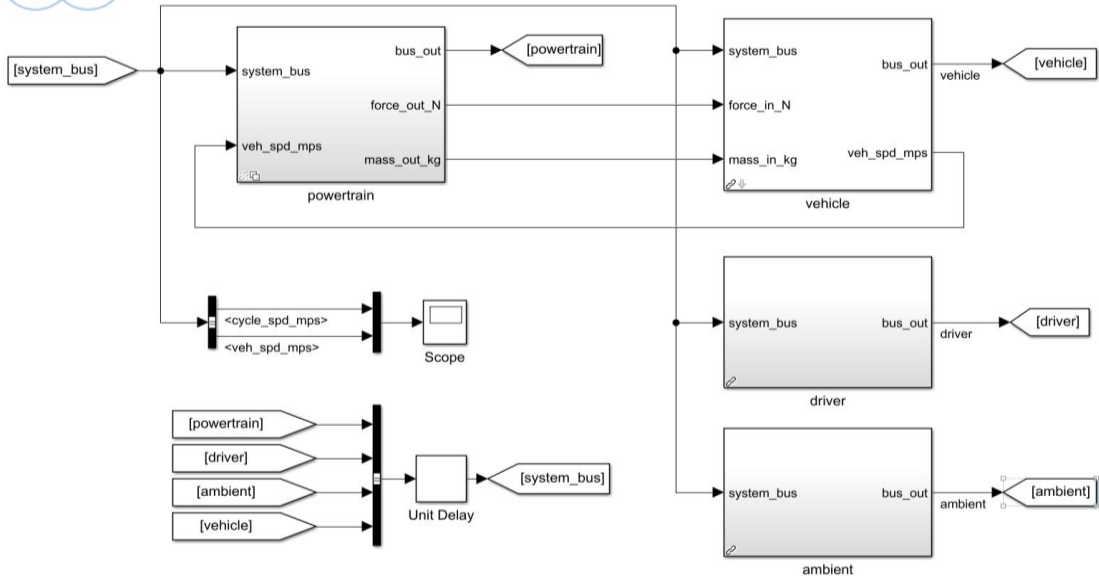

- Constructed in Simulink
- Engine
- Transmission (AT/CVT/AMT/DCT)
- Wheels & Axles
- Chassis & Roadload
- EV & Hybrid Powertrains (not released publically yet)

ALPHA Engine Model

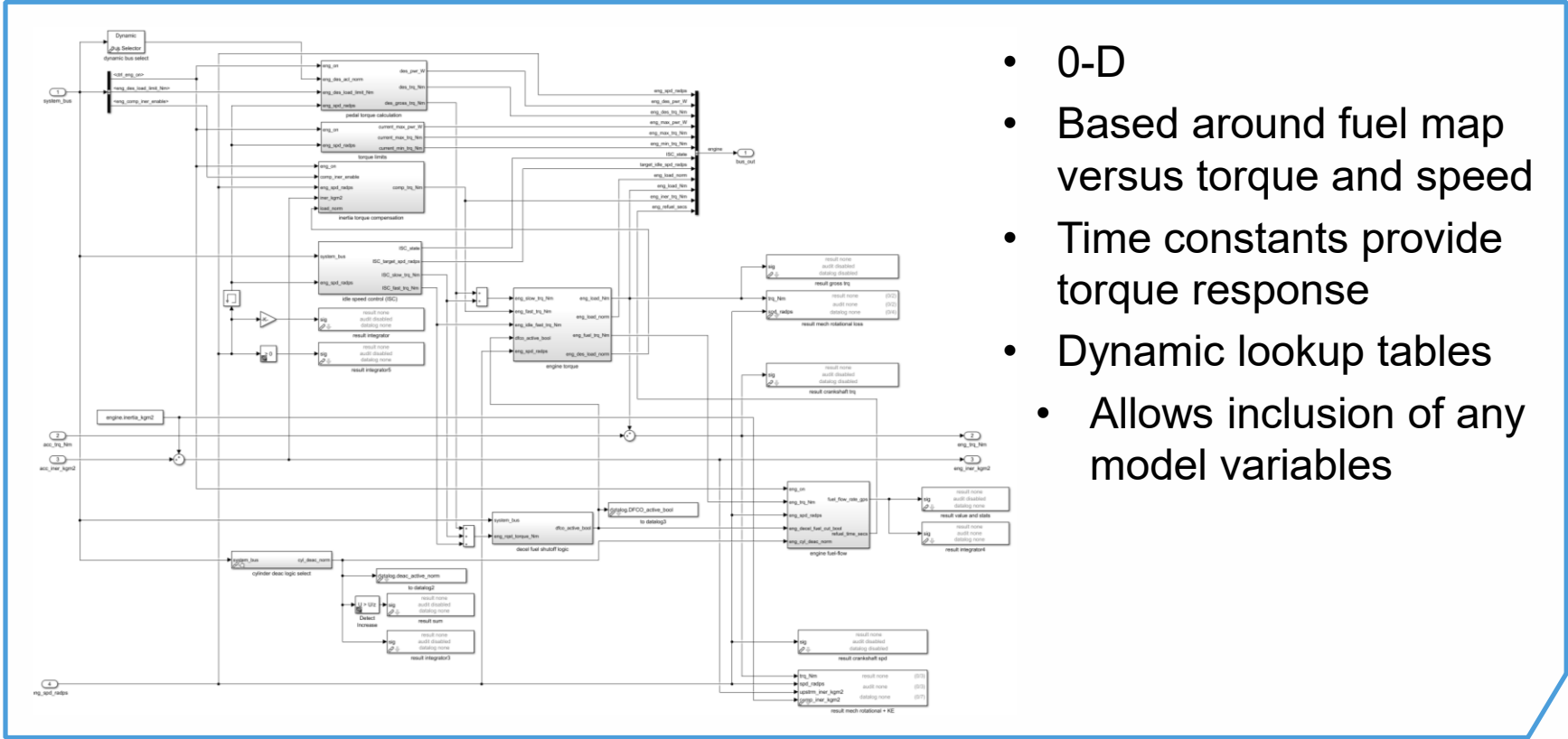

- 0-D
- Based around fuel map versus torque and speed
- Time constants provide torque response
- Dynamic lookup tables
- Allows inclusion of any model variables

Base fuel map accounts for 95+% of fuel consumption

Other adjustments for transient operation applied beyond base fuel map:

- Deceleration fuel cutoff
- Cylinder deactivation transitions
- Transient fueling
- Enrichment
- Inertia compensation during transmission shifting

Engine Dynamometer Test Data

Three Areas with Different Test Methods

- Low / Mid-Load – Core Map
Long Steady State Modes
Stable Speed, Torque & Fuel
Stoichiometric - Limit $\lambda = 1$
- Low Speed / Near Idle
- High Load – Transient

Sample Test Points for
2016 Honda 1.5L Turbocharged I4

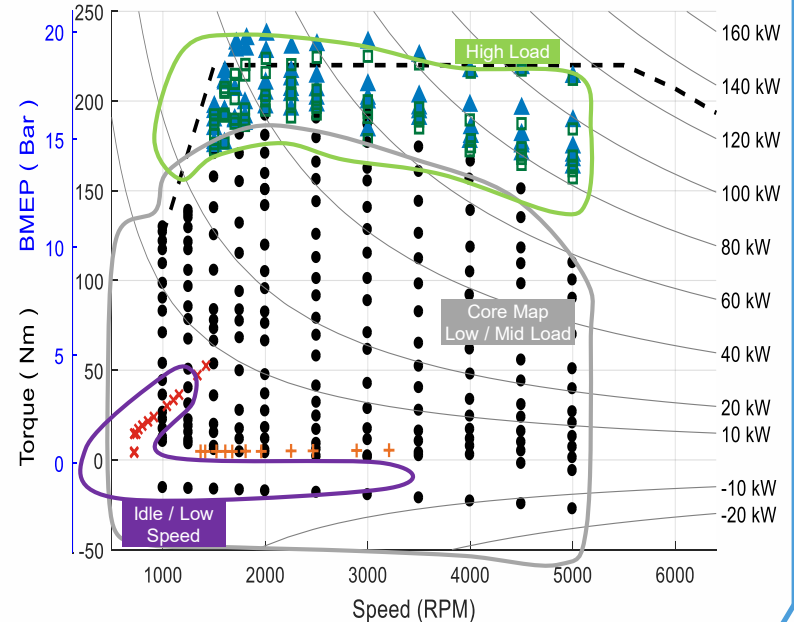

Test data available at:

www.epa.gov/vehicle-and-fuel-emissions-testing/test-data-light-duty-greenhouse-gas-ghg-technology

Challenges Testing as Low Speed

- Large dynamometer inertia and high torsional stiffness make low speed operation difficult
- Engine operation can interact with engine control logic leading to instability

Example Setup with CVT

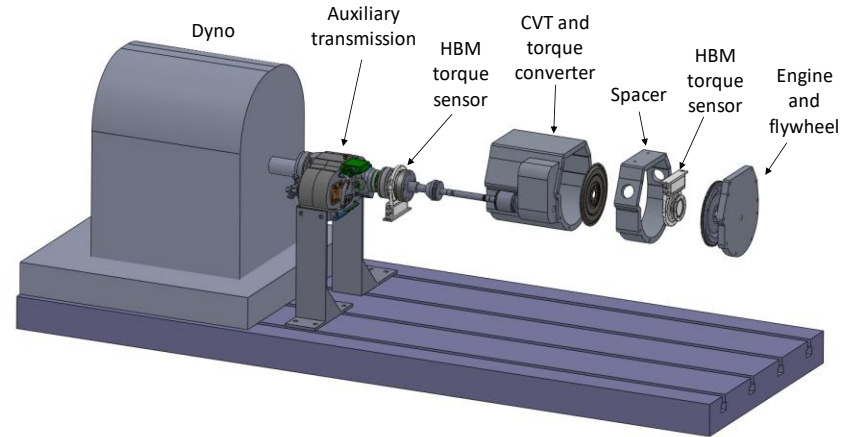

Options:

- Incorporate a transmission into the test setup
- Perform in-vehicle fuel consumption measurements

High Load Test Data

Defines Two Time Windows

- Initial – After engine achieves desired operation point (often stoichiometric)
- Final – Similar to steady state, may be limited by time or temperature criteria
 - Data may not be stable

Need Reliable Fuel Flow Measurement over Short Duration

- Estimate fuel flow via injector duration and fuel pressure

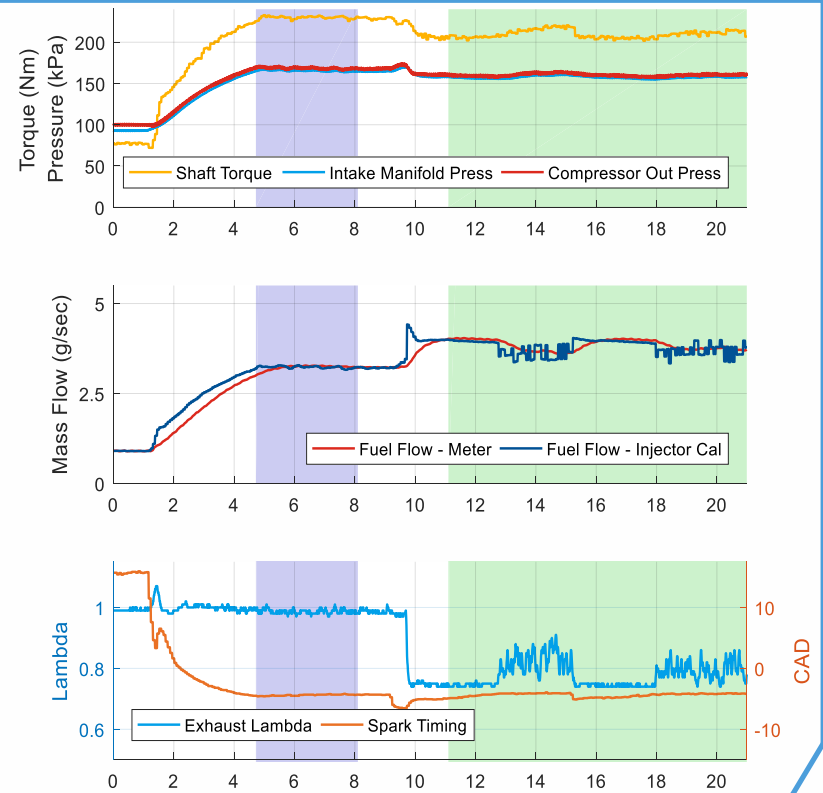

Capturing Data from Published Images

Valuable Source of Relevant Data

- Timely
- Low Effort

Important Considerations:

- Often Partial Maps
- Unknown Test Procedures
- Development Status
- Fuel Properties

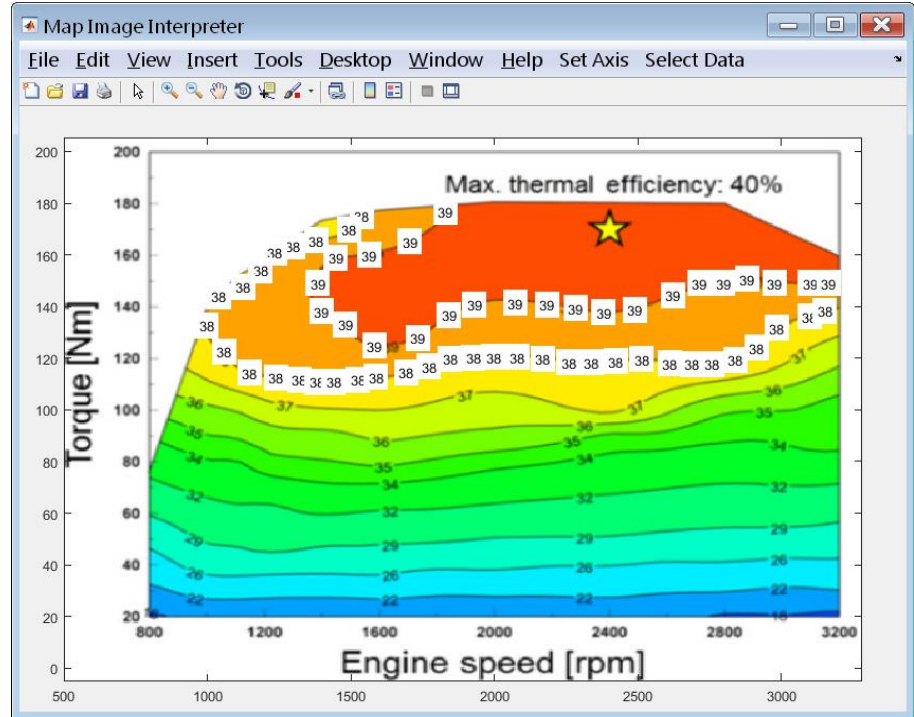

ALPHA Engine Map Generation Overview

1. Define operating envelope to be covered by the map
2. Define speed and load grid for fuel map construction
3. Generate fuel map from input data
4. Examine resulting fuel map and revise data if necessary
5. Apply adjustments for transient operation

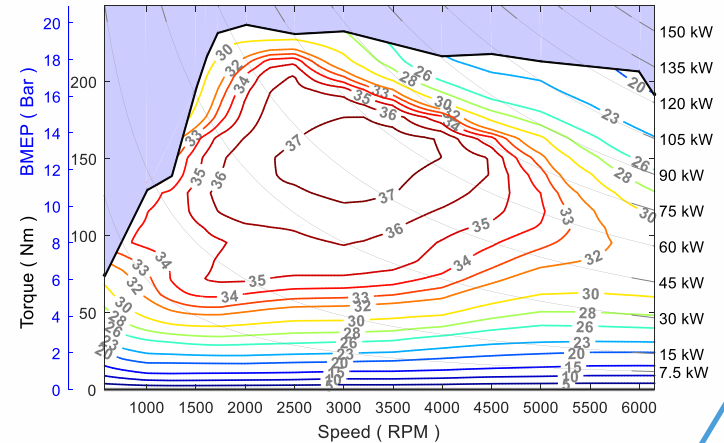
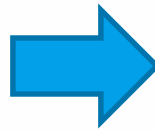
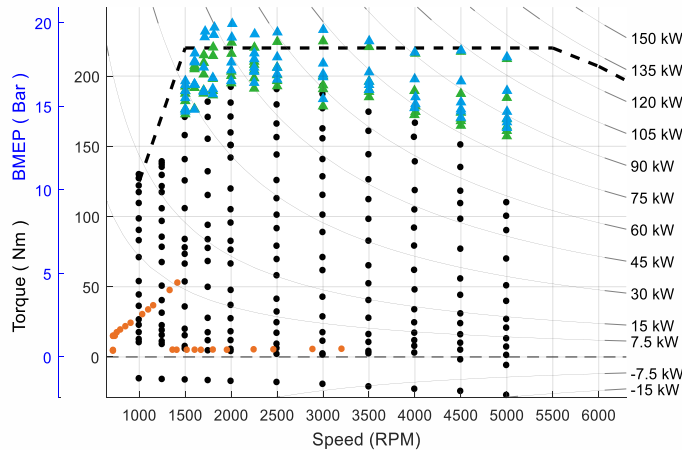

Defining Operating Range – Maximum Torque

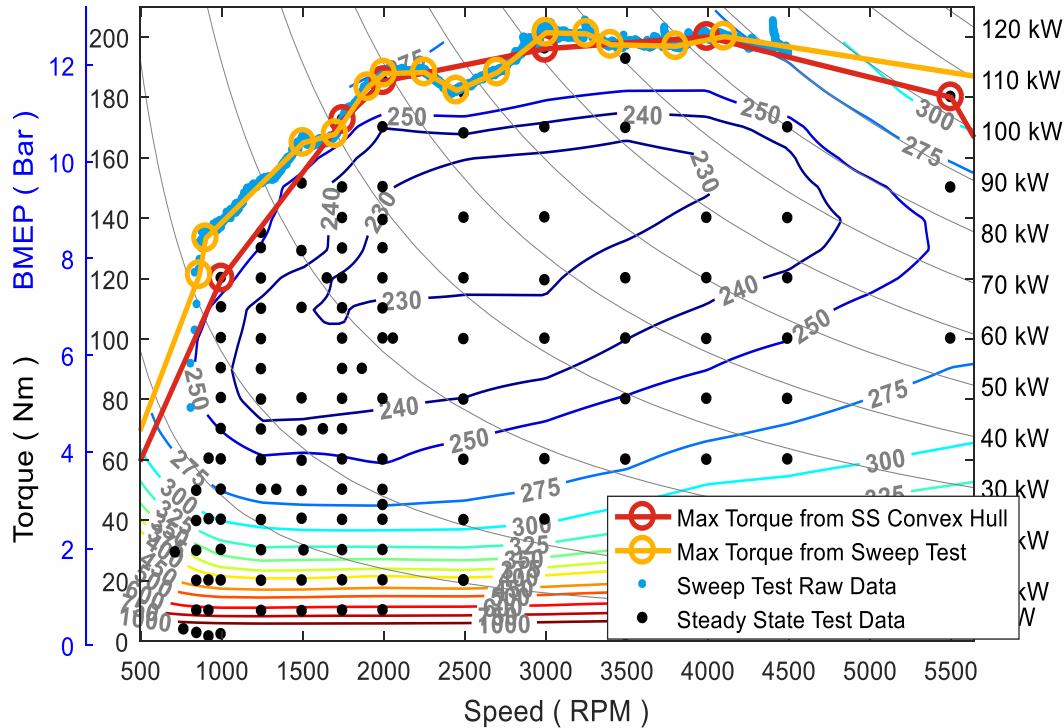

Provides a Bound to Construct Fuel Map Grid

Important for Determining Engine Displacement in Fleet Level Modeling

- Future technology packages must maintain performance
- Higher power creates more opportunity to downsize

Defining Operating Range – Maximum Torque

Maximum Torque – Sweep vs Stab Test

Sweep Speed at Maximum Torque

- Fast, easy test to execute
- Can show features that otherwise may be overlooked
- Slow transient can cause thermal protection to limit torque at high speed
- Fast transient increases error in torque measurement due to inertia

Torque Stab at Fixed Speed - Preferred

- More tedious, especially for a fine grid
- Provides greatest torque measurement accuracy
- Provides additional information about fueling during transient operation

Defining Operating Range – Minimum Torque

Minimum Torque Curve Impacts:

- Available energy for mild hybrids
- Advanced alternator strategies

Can be Constructed Using:

- Steady state dynamometer test data
- Need a default curve for maps built from published images
 - Biased toward higher friction
 - May be revised using the fuel map

Default Minimum Torque Curve

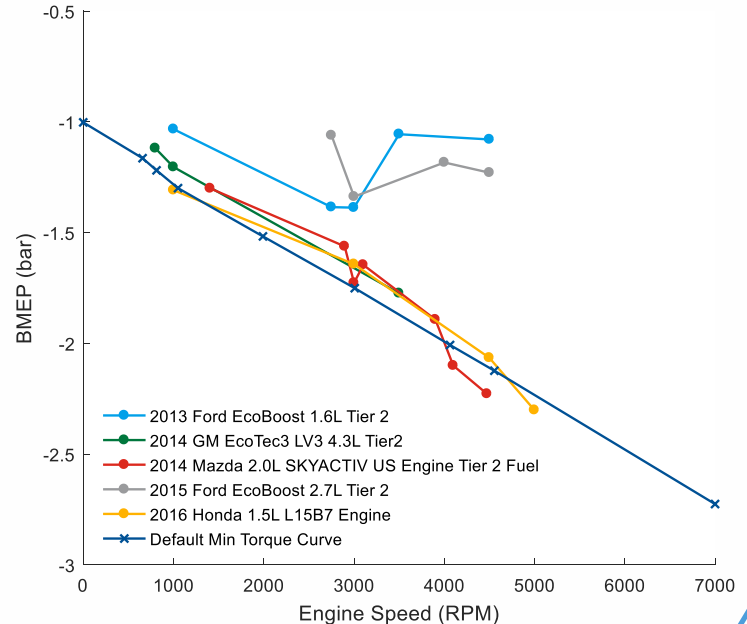

Defining the Fuel Map Grid

Gridded Fuel Map Desirable to Simplify Interpolation and Speed Simulation

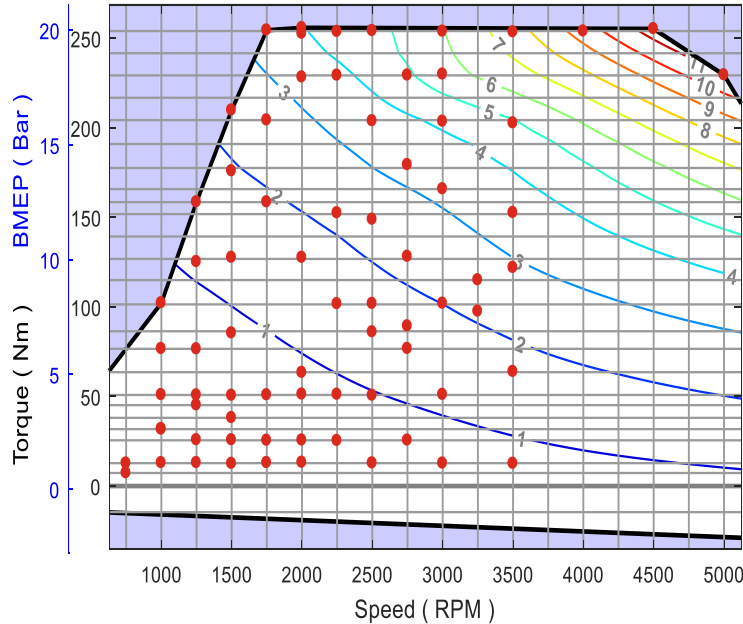

- Build grid to match input data
- Look for clusters in speed & torque data
 - Minimum spacing between clusters
 - Minimum number of points per cluster
- Add intermediate grids for sufficient coverage
 - Linear interpolation of a non-linear surface
- Image based maps use a default grid

Surface Fitting - Normalization

- Distance determines weighting for surface fitting
- Scattered data necessitates speed & torque data points be of similar scale to generate satisfactory results
- Regions surrounding each input data point influence the resulting fuel map
- Appropriately balanced weighting of neighboring points

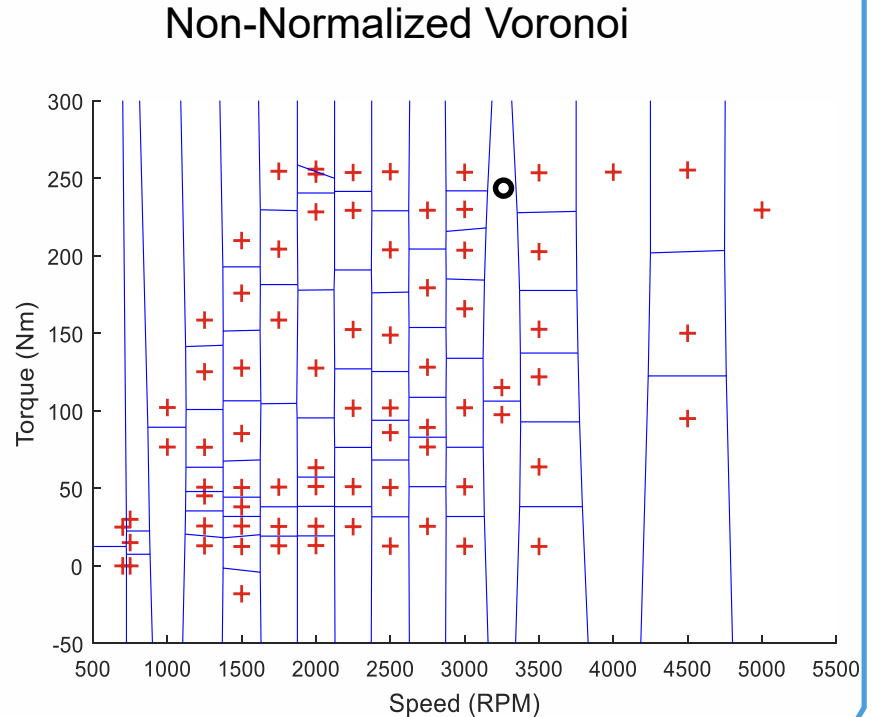

Surface Fitting - Normalization

- Distance determines weighting for surface fitting
- Scattered data necessitates speed & torque data points be of similar scale to generate satisfactory results
- Regions surrounding each input data point influence the resulting fuel map
- Appropriately balanced weighting of neighboring points

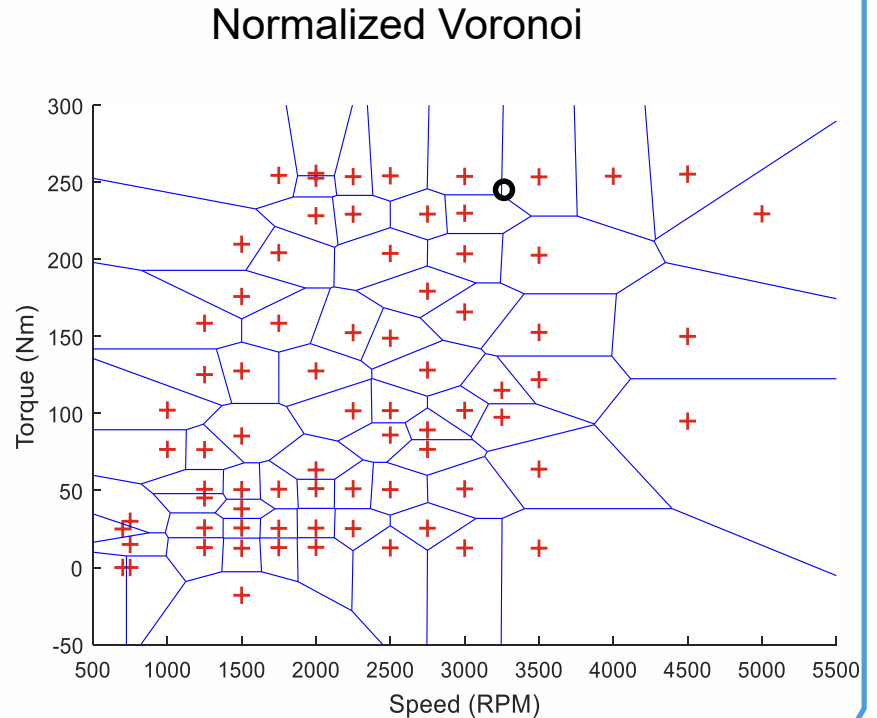

Surface Fitting - Normalization

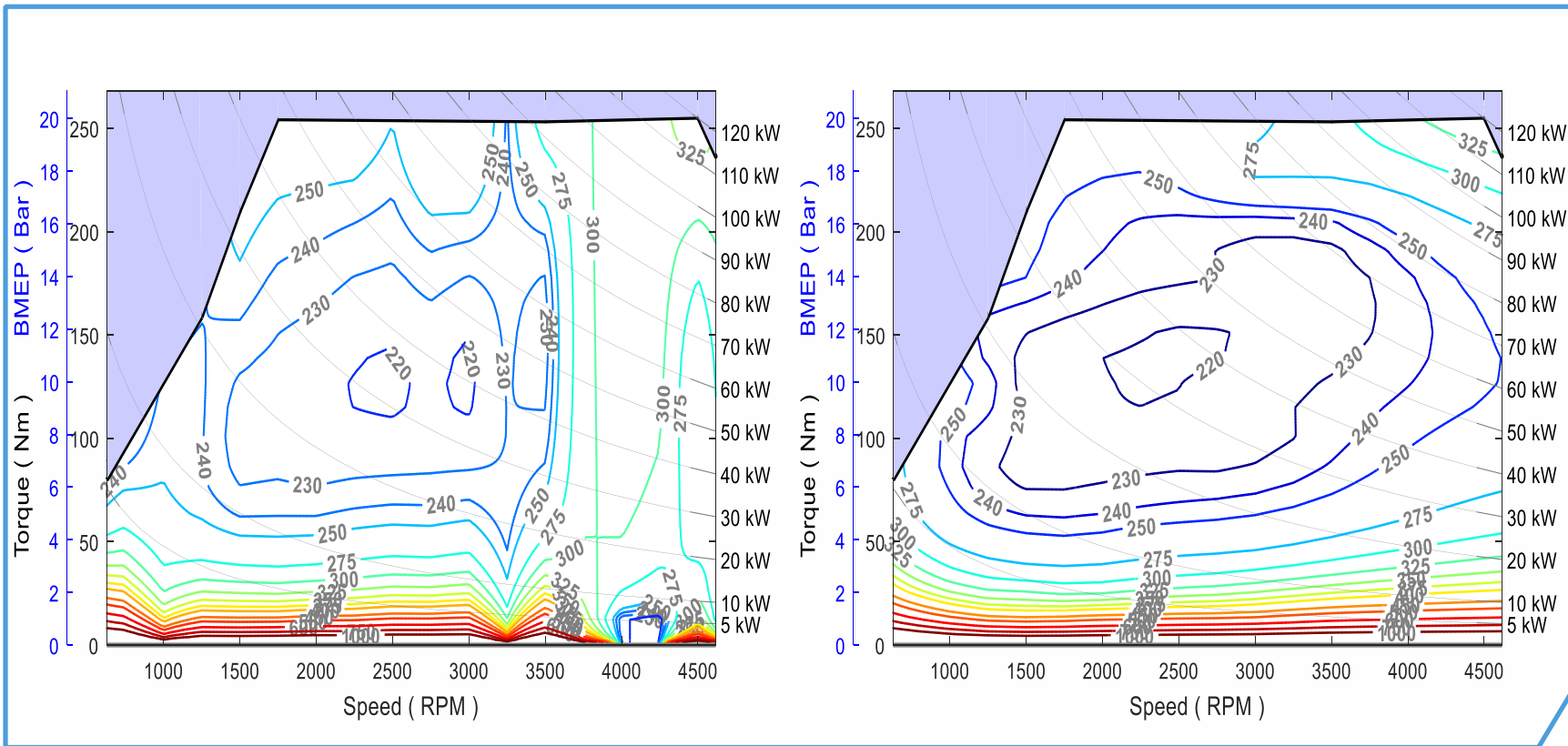

Interpolation vs Surface Fitting

Behavior of Matlab's *Scattered-Interpolant* Class – Triangulation of Data
 Each grid point is determined by plane of three surrounding input points

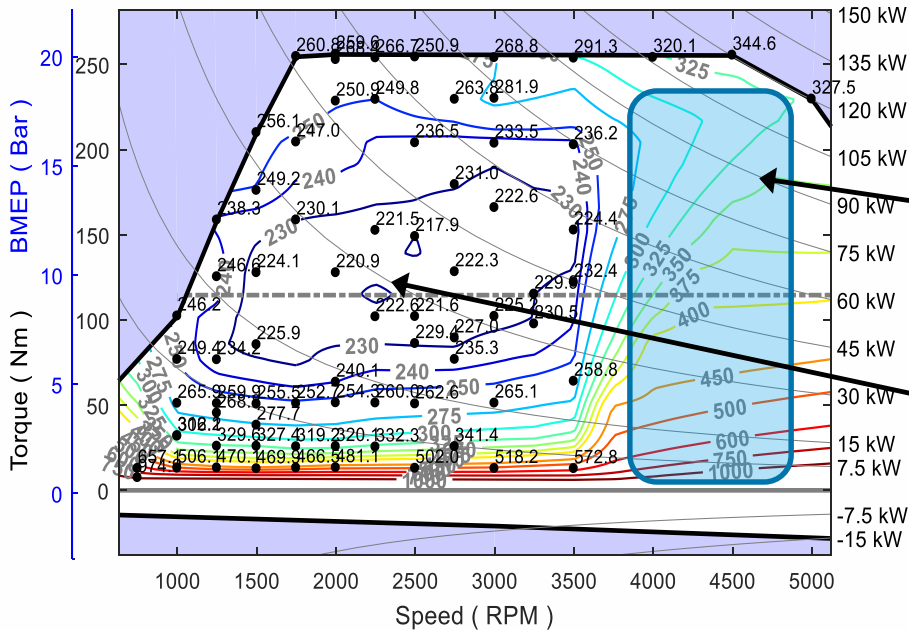

Large Void Impacts
 Expected Overall Trend

Missing Peak Island

GRIDFIT is a not an interpolant

Generates system of equations and seeks to minimize:

- Error between data and surface
- 2nd derivative of the resulting surface
- Smoothness is the relative weighting

A Smooth Fuel Map:

- Ensures more consistent gear selection behavior
- Assists in generating a more regular knock sensitivity adjustment when scaling engine maps

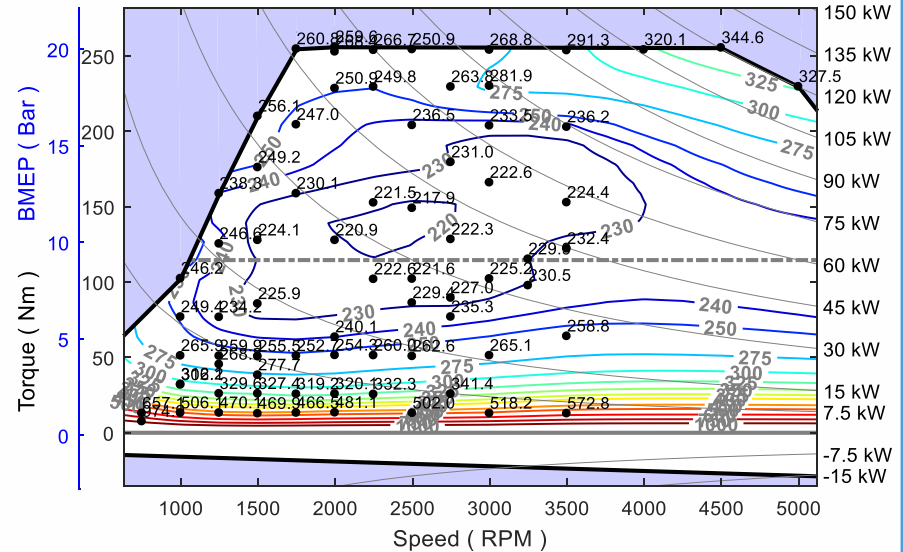

* GRIDFIT developed by John D'Errico

Interpolation vs Surface Fitting

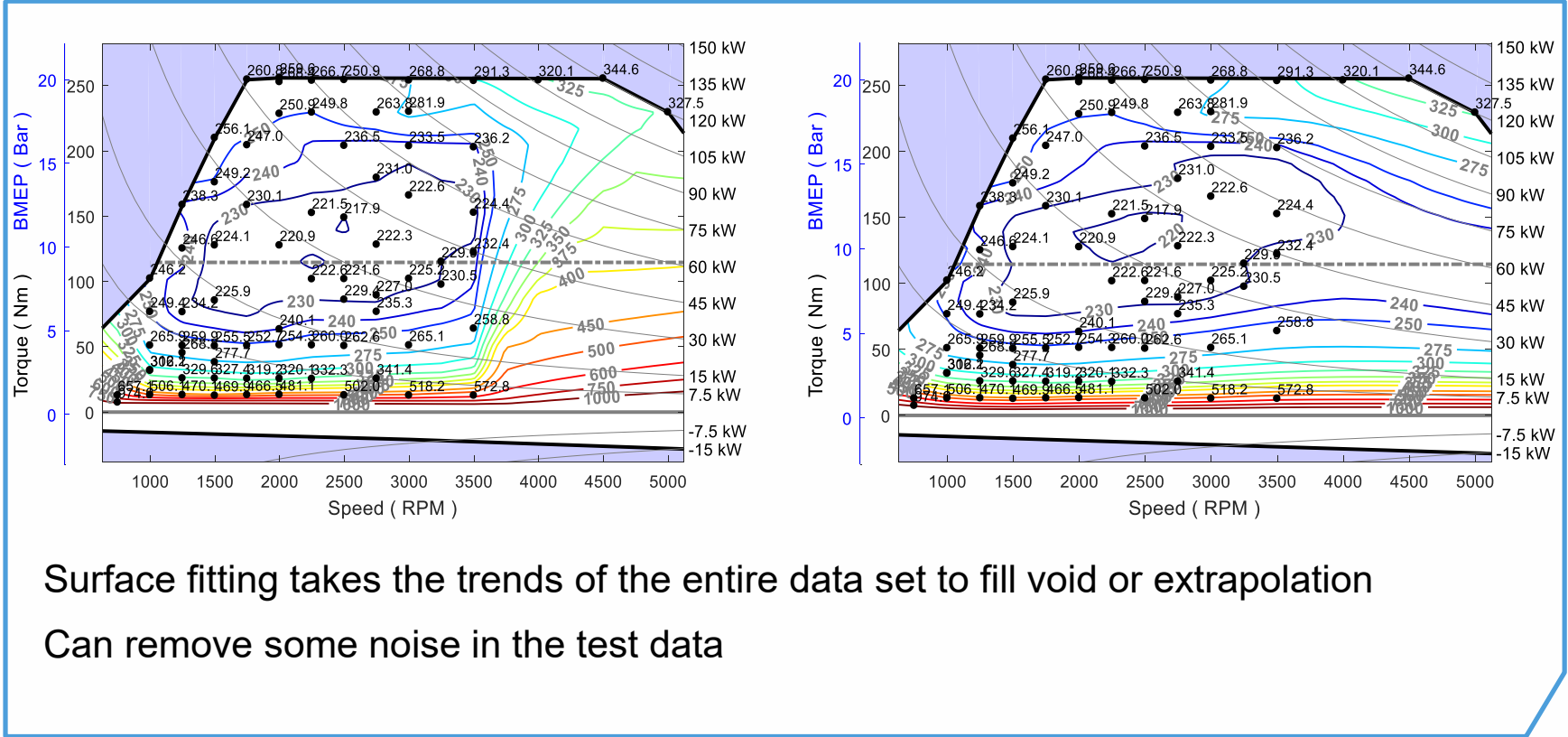

Surface fitting takes the trends of the entire data set to fill void or extrapolation
 Can remove some noise in the test data

Quality Checks Confirm the Accuracy of the Resulting Fuel Map

Iterative Process to Ensure the Final Map Represents Appropriate Trends

Conducted by:

- Comparing input data with the resulting BSFC or BTE contour plots
- Verifying the trends within any areas of the map which are extrapolated from test data sets match expectations
- Applying reasonable judgment and adding a collection of estimated data points as needed or further examination of source data
- Comparing fuel flow to chassis test measurements & similar engines or vehicles
 - can be difficult to obtain in-vehicle torque measurements

QC - Handling Limited Data Sets

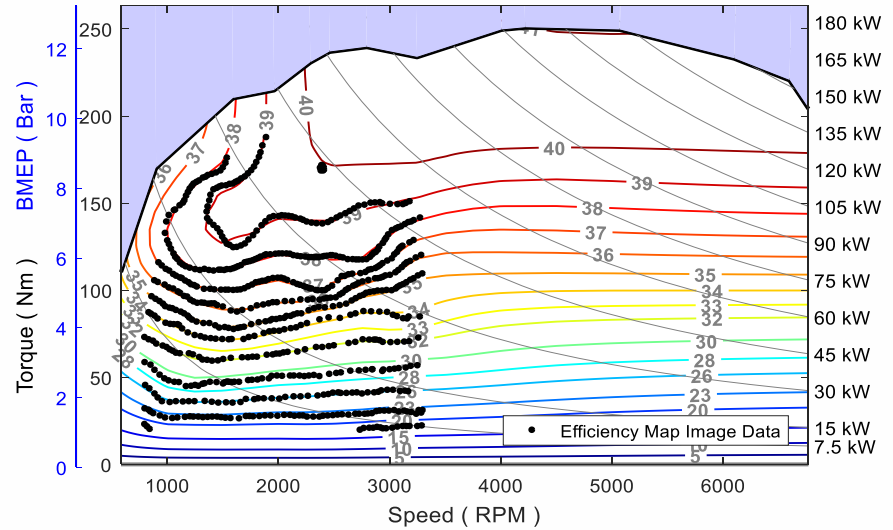
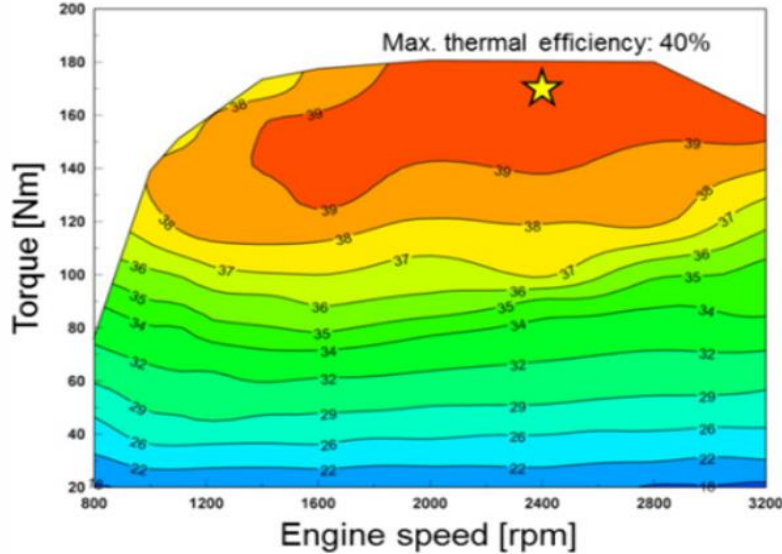

- Published images often provide partial maps
- Need to correct poor extrapolation
- Ensure appropriate controls behavior in simulation

QC – Adding Data Points

Adding estimated data points creates a more appropriate fuel map

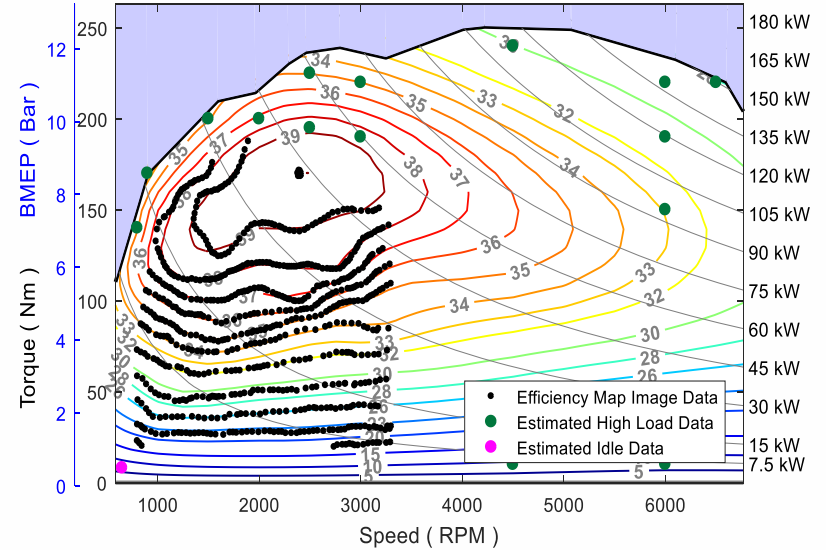
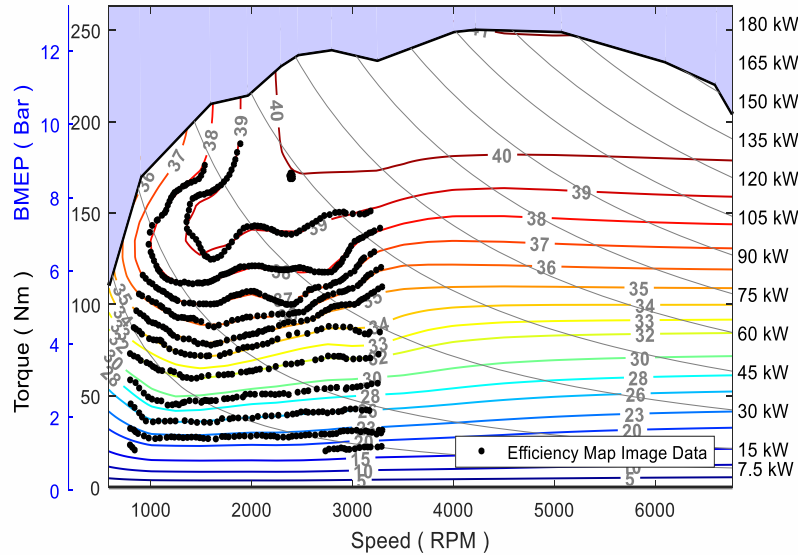

QC – Fuel Linearity Plots

Fuel per Stroke Contour Plot

Roughly Parallel to Minimum Torque

Reduced Efficiency at Idle

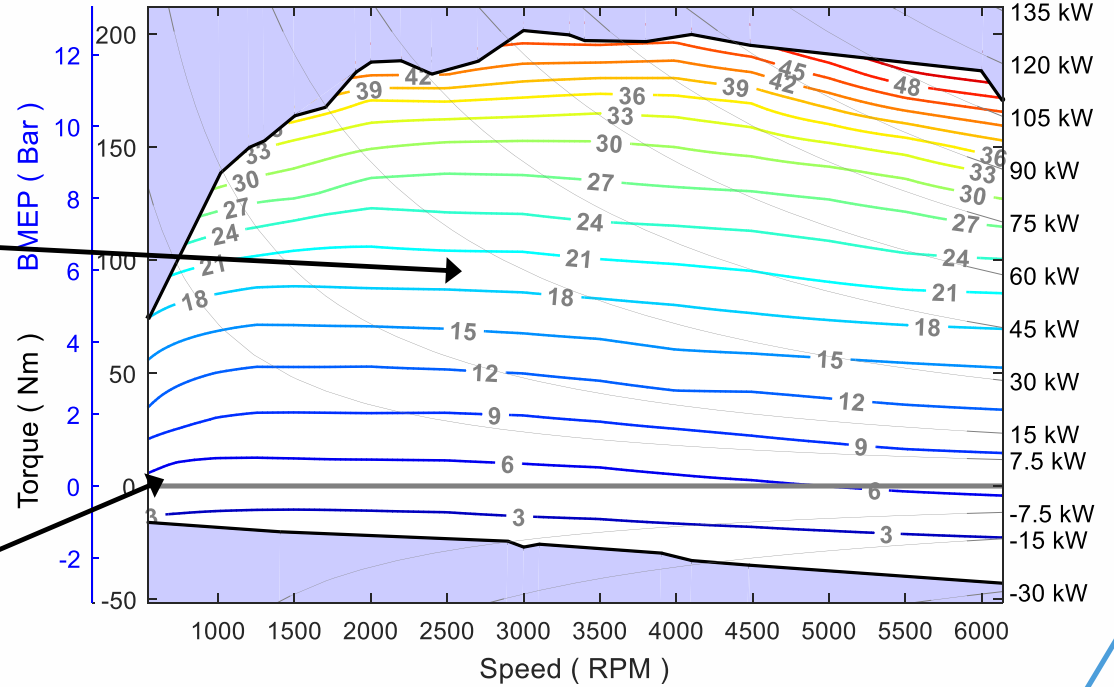

QC – Fuel Linearity Plots

Fuel per Stroke vs Torque

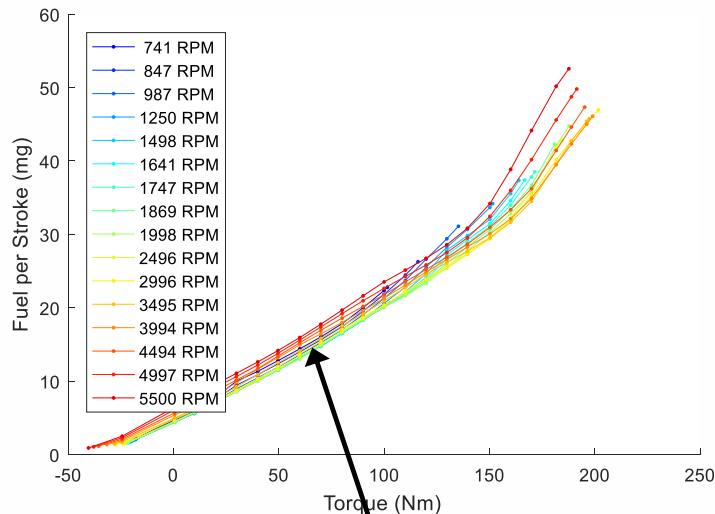

**Roughly Parallel
Increasing consumption with speed**

Power Enrichment

Knock Control

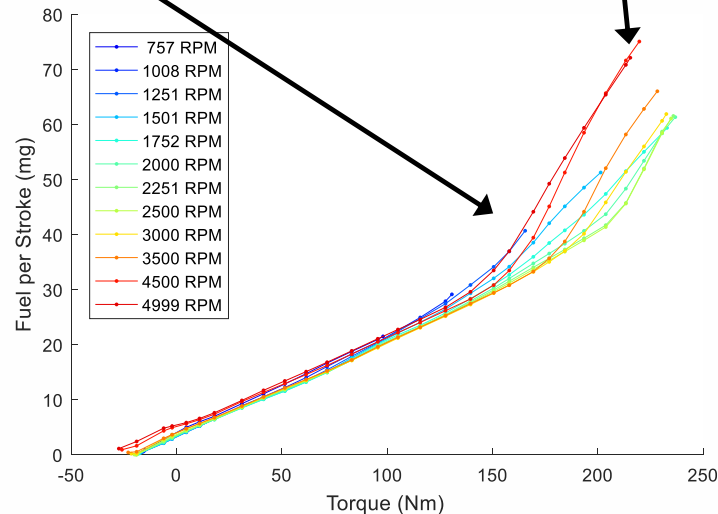

- Deceleration Fuel Cutoff *
- Cylinder Deactivation Transitions *
- Transient Fueling *
- Enrichment
- Inertia Compensation During Transmission Shifting *

* More detailed discussion of how these factors are implemented in ALPHA is described in SAE Technical Paper 2017-01-0533

Post DFCO Additional Fueling

Additional fueling following fuel cut-off event

Easy to capture on engine dynamometer or via chassis testing

Default adjustment factor

- 1.3x multiplier
- Ramped out over 1.1 seconds
- Only activates after 2 seconds

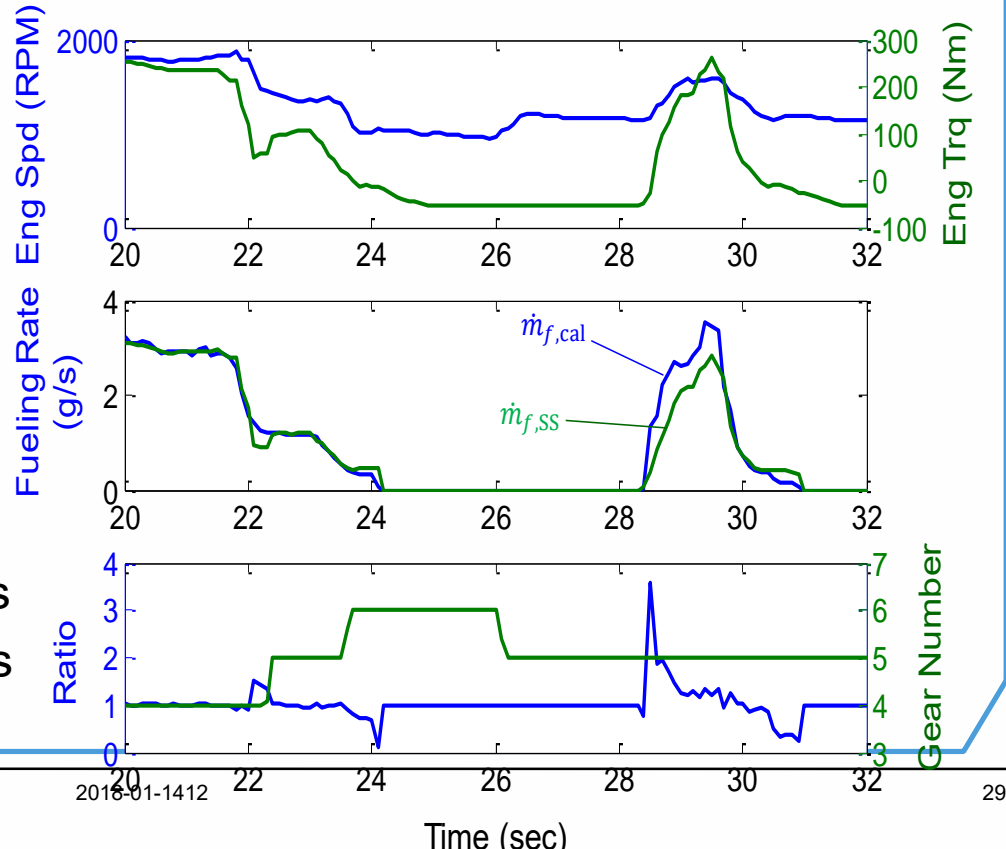

Cylinder Deactivation Adjustment

Developed Based on Observations of 2014 Chevrolet Silverado

CDA Engagement

- Reduction in fueling not instantaneous
- Default transition blending: 1 second

CDA Disengagement

- Additional fueling beyond non-CDA level
- Default adjustment 1.3x multiplier ramped down over 2 seconds

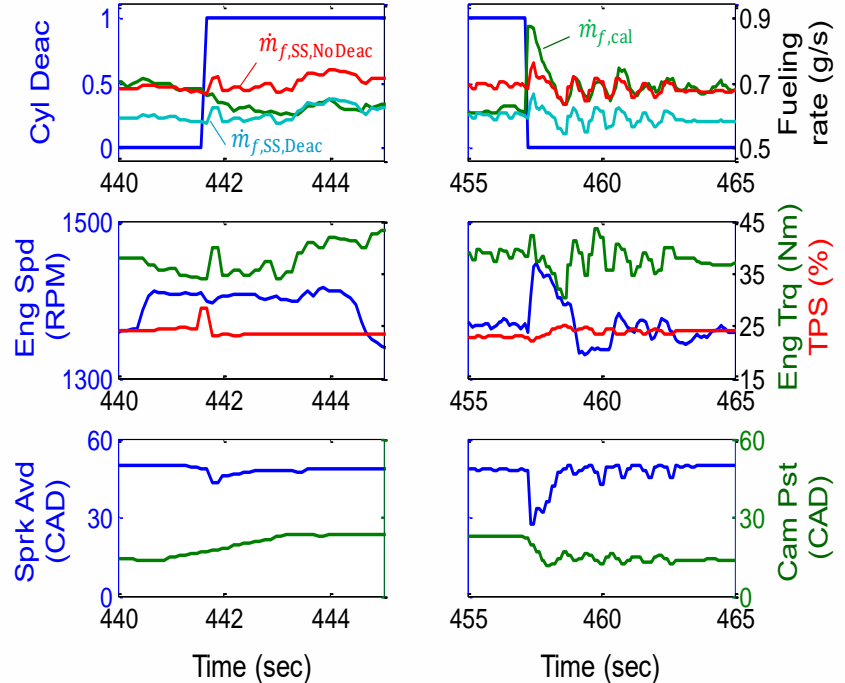

Transient Operation Adjustment

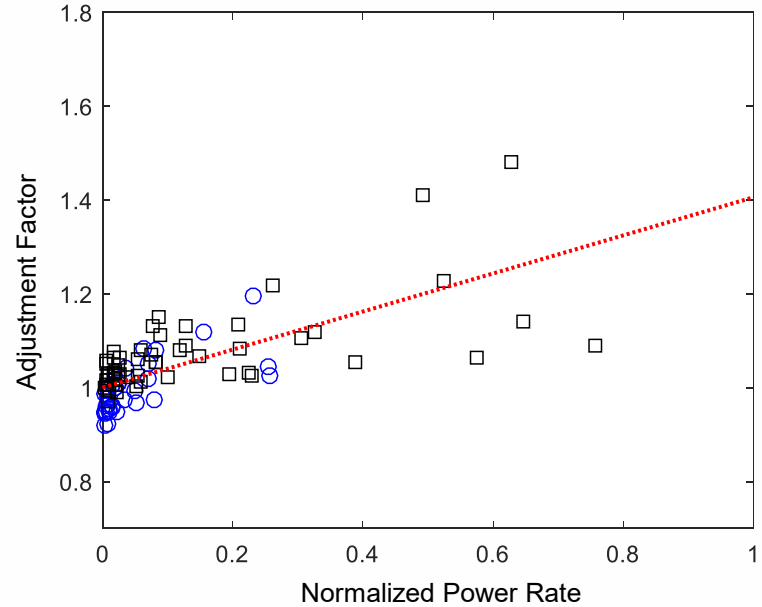
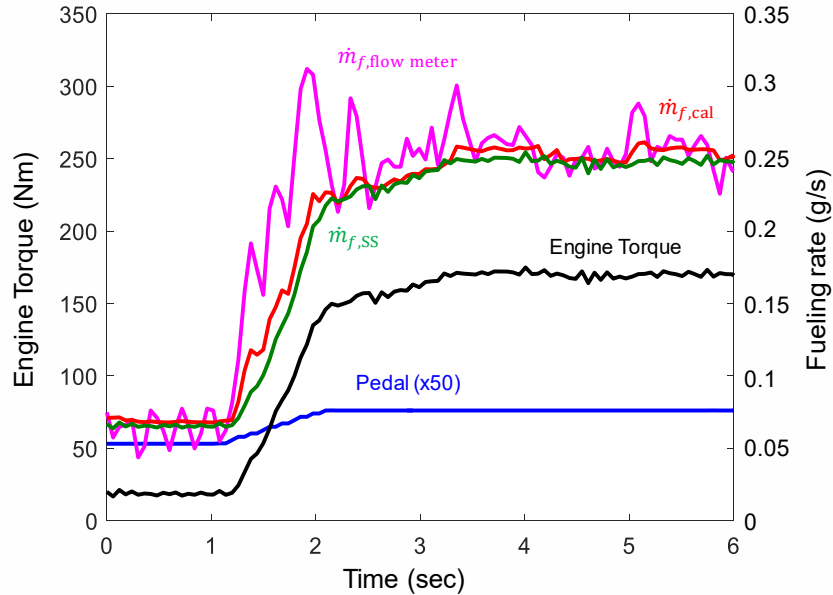

Transient operation is observed to be less efficient than steady state
 Default adjustment multiplier is 1.4 scaled by engine power rate
 Rarely observe normalized power rate above 0.3

Simulating Enrichment Depends on:

- Amount of additional fuel to add
- How / when to transition from stoichiometric operation to enriched operation

High load test method provides a good method to determine both

Off-cycle Phenomena

Point of Reference for Engine Scaling

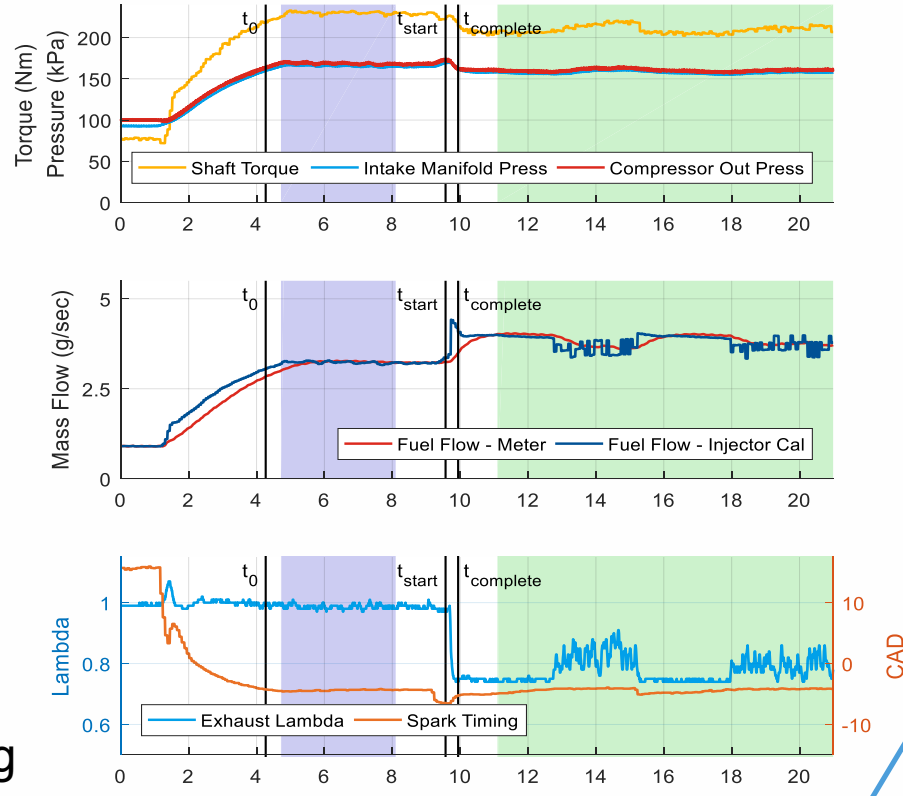

Summary – All Areas of Operation

Maps Covering All Areas of Engine Operation

- Low / Mid-Load
- Low Speed / Near Idle
- High Load – Transient

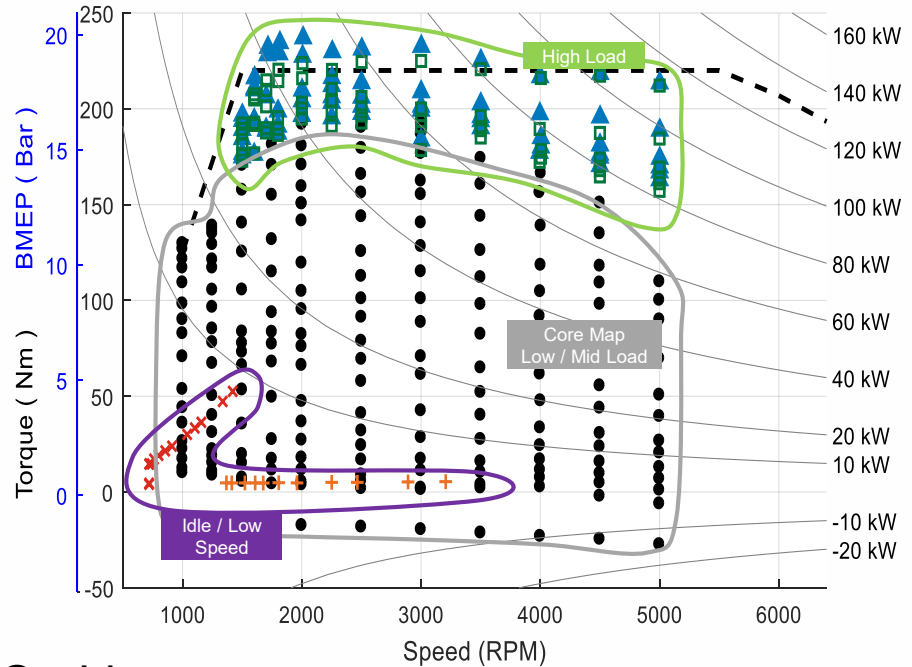

Test Data & Input Files Available On-Line:

www.epa.gov/vehicle-and-fuel-emissions-testing/test-data-light-duty-greenhouse-gas-ghg-technology

Summary – Consistent Engine Map Process

1. Define operating envelope
2. Define speed & load grid
3. Generate fuel map
4. Examine resulting map
5. Apply transient adjustments

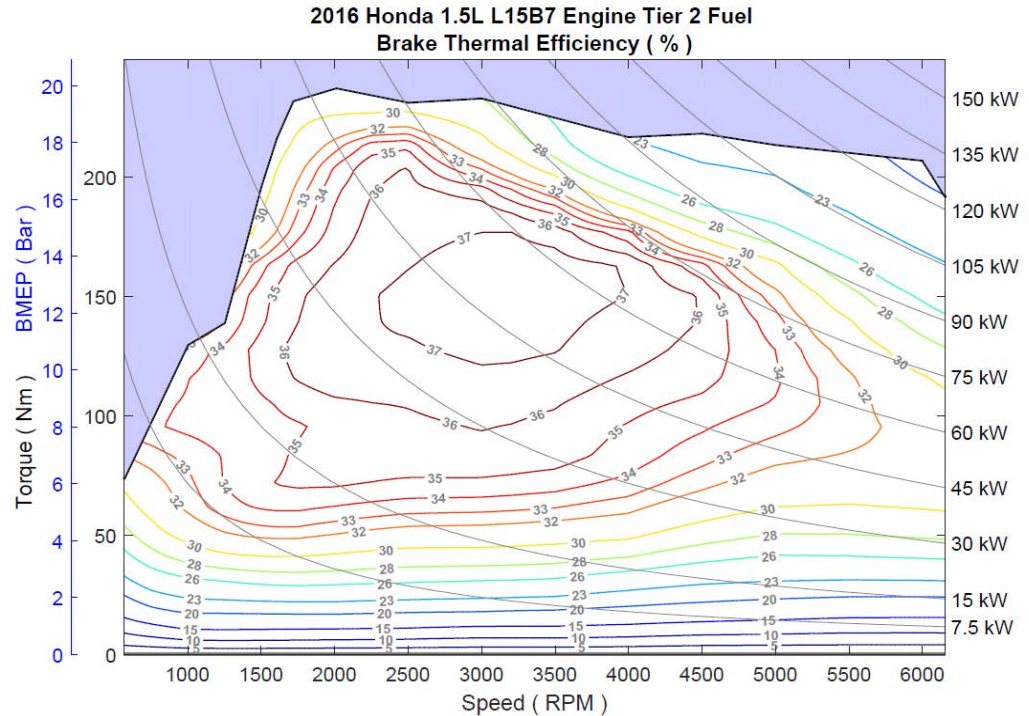

ALPHA & Input Files Available On-Line:

www.epa.gov/regulations-emissions-vehicles-and-engines/advanced-light-duty-powertrain-and-hybrid-analysis-alpha

Includes:

- Generation process document
- Resulting ALPHA input m-file
- Fuel map images and data

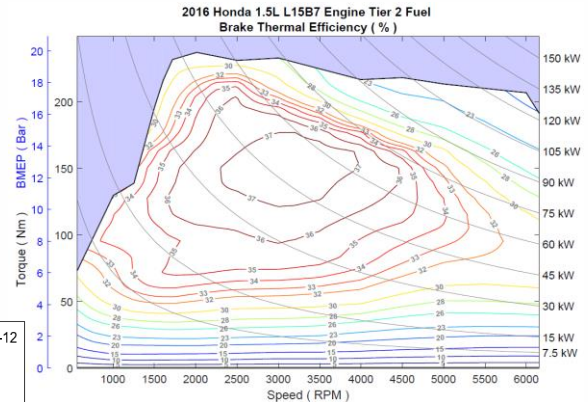

2016 Honda 1.5L L15B7 Engine Tier 2 Fuel - ALPHA Generation Process

Version: 2018-03-12

This document summarizes the process which utilized EPA's laboratory engine and chassis dynamometer test data to generate a full engine fuel consumption map for the Honda L15B7 downsized turbocharged 1.5L engine from the 2016 Honda Civic tested on Tier 2 fuel. The generated full engine map defines the complete operating boundaries of the engine which are needed for ALPHA modeling including idle, WOT, minimum torque, and maximum speed.

SUGGESTED CITATION:

2016 Honda 1.5L L15B7 Engine Tier 2 Fuel - ALPHA Map Package. Version 2018-03. Ann Arbor MI: US EPA National Vehicle and Fuel Emissions Laboratory, National Center for Advanced Technology, 2018.

Engine Physical Characteristics