

The following transmittal memo and the attachment with appendices explains the Industrial Wastewater Alternative Control Technology document which is a compendium of three references. The three references are the report "Revisions to Impacts of the Draft Industrial Wastewater Control Techniques Guideline" (attached), the September 1992 draft Industrial Wastewater Control Techniques Guideline (available on the TTN), and the Hazardous Organic NESHAP (also available on the TTN).

**MEMORANDUM**

SUBJECT: Transmittal of Alternative Control Technology Documents

FROM: Bruce C. Jordan, Director  
Emission Standards Division (MD-13)

TO: Director, Air, Pesticides, and Toxics  
Management Division, Regions I and IV  
Director, Air and Waste Management Division,  
Region II  
Director, Air, Radiation, and Toxics Division,  
Region III  
Director, Air and Radiation Division,  
Region V  
Director, Air, Pesticides, and Toxics Division,  
Region VI  
Director, Air and Toxics Division,  
Regions VII, VIII, IX, and X

As described in the January 20, 1994 memorandum to you from John Seitz, we are planning to make available Alternative Control Technology (ACT) documents for the control technology guideline (CTG) source categories for which we have not yet published final CTG documents. The ACT for "Volatile Organic Liquid (VOL) Storage Tanks" was mailed to you on January 31, 1994 and the ACT documents for "Clean-up Solvent", "Batch Operations", and "Plastic Parts" were sent on February 24, 1994.

Attached are the ACT documents for the control of volatile organic compound emissions from "Industrial Wastewater (IWW)," "Shipbuilding," and "Automobile Refinishing." The IWW ACT document is a compendium of three references, only one, "Revisions to Impacts of the Draft Industrial Wastewater Control Techniques Guideline" of which is attached. The other two, the September 1992 draft IWW CTG (announced for public comment on December 29, 1993), and the final Hazardous Organic NESHAP (HON) (59 FR 19402, April 22, 1994) are available on the Technology Transfer Network (TTN). Although the HON addresses the control of hazardous air pollutants instead of volatile organic compounds, it is serving as the example wastewater rule. The HON can be found under the "Clean Air Act Amendments (CAAA) Recently Signed Rules Menu" and the draft IWW CTG can be found under the

"CAAA Main Menu", "Title I", "Policy and Guidance". We are planning to put the Shipbuilding and Automobile Refinishing ACT documents on the TTN. All three documents may be obtained in limited supply from the OAQPS Library at (919) 541-5514. We have

also included an unbound copy of the Shipbuilding and Automobile Refinishing ACT documents for you to have available for xeroxing, as desired.

If you have questions on these ACT documents, please contact Elaine Manning at (919) 541-5499 for IWW, Mohamed Serageldin at (919) 541-2379 for Shipbuilding, and Mark Morris at (919) 541-5416 for Automobile Refinishing.

We have also found two problems with in the Plastic Parts ACT documents that were sent to you in February. First, there was an error on page 4-3a (table 4-1) concerning black and reflective argent, air bag cover, and soft coatings. Second, some copies of the document were missing pages 6-4 to 6-6 (tables 6-2 to 6-4). Four pages to correct these two problems are attached. If you have questions on the Plastic Parts ACT document please contact Dave Salman at (919) 541-0859.

4 Attachments

cc: State and Local Air Pollution Control Agency Contacts (STAPPA/ALAPCO) w/o Attachments

## Revisions to Impacts of the Draft Industrial Wastewater Control Techniques Guideline

### **Purpose**

The purpose of this notice is to provide the States with interim guidance to aid in development of rules in the absence of the final Industrial Wastewater (IWW) Control Techniques Guideline (CTG). This notice gives an overview of the changes that have been made to the draft IWW CTG, provides several clarifications, and presents the revised options tables for States to use to select RACT (see Appendix A).

### **Background**

In the December 29, 1993 Federal Register notice announcing the availability of the draft IWW CTG, the Environmental Protection Agency stated their intent to revise the final IWW CTG to reflect changes that were made in the wastewater provisions of the Hazardous Organic NESHAP (HON) (59 FR 19402, April 22, 1994). These changes consisted of adjustments made to the values for the fraction emitted (Fe), the fraction measured by Method 25D (Fm), the fraction removed by steam stripping (Fr). The Agency's intent has been and continues to be that the wastewater collection and treatment control philosophy will be consistent between the IWW CTG/ACT and the HON. This does not preclude other differences that may occur between the two. The CTG/ACT and the HON will continue to differ in the compounds that are the basis for control, the CTG/ACT addresses volatile organic compound (VOC) emissions and the HON is concerned with Hazardous Air Pollutant (HAP) emissions. While controlling HAP emissions the HON does get a significant amount of VOC control also. The HON is a national standard for the chemical industry while the CTG/ACT addresses facilities in ozone non-attainment areas in four separate industry groups. For these reasons States should consider lower cutoffs for concentration and flow than those found in the HON, such as were identified in the draft CTG, to obtain additional control of VOC emissions in non-attainment areas as necessary. Based on the similarities between the CTG/ACT and the HON, the HON wastewater provisions are recommended as the model wastewater rule.

### **Changes to the IWW CTG**

The Fe, Fr, and Fm values in the CTG/ACT have been revised to reflect changes made in the development of the final HON wastewater provisions. Appendix B is a list of the new values of Fe, Fm, and Fr for compounds presently in our data base. The April 14, 1994 memorandum "Estimation of Compound Properties: Correlations for Fm, Fr, and Fe" (Appendix C) explains the correlations used to determine values for the compounds where the Fe, Fr, and Fm values were not known.



The changes made to the Fe values for HAP under the HON are documented in the February 2, 1994 memorandum "Estimation of Air Emissions From Model Wastewater Collection and Treatment Plants", which is available in the HON docket. These Fe values are used in the CTG/ACT. The Fe values in the CTG/ACT for non-HAP VOC were based on a correlation between the estimated value of Fe and the Henry's law constant at 25 °C developed based on the HAP covered by the HON.

The method used to estimate Method 25D Fm values is described in the HON Docket Memo "Prediction of the Fraction Measured (Fm) of Hazardous Air Pollutants from Method 25D and Method 305 Using UNIFAC Methods" dated January 7, 1993. Again, the non-HAP VOC Fm values that were not estimated in this memo were calculated based on a correlation between the Method 25D Fm value and the Henry's law constant at 25 °C.

The design steam stripper used in the draft CTG and the proposed HON changed based on comments received on the HON. These changes to the design steam stripper resulted in changes to the Fr values. The revised design steam stripper is detailed in the February 7, 1994 memorandum "Estimating Steam Stripper Performance and Size". The costing for the revised steam stripper is explained in the February 1, 1994 memorandum "Steam Stripper Total Capital Investment and Total Annual Costs". Both memorandums can be found in the HON docket. In the draft CTG the Fr values were based on VOC groups. Based on changes made in the final HON, the Fr values for the CTG/ACT were developed on an individual compound basis. The VOC Fr values that were not estimated for the HON were determined by a correlation between the Henry's law constant at 25 °C and the Henry's law constant at 100 °C. The Henry's law constants at 100 °C were then used to calculate the VOC Fr values as explained in the January 7, 1994 memorandum "Efficiency of Steam Stripper Trays to Treat Wastewater Streams: Prediction of the Fraction Removed (Fr) for Specific Compounds".

Another change to the draft IWW CTG is to limit the compounds to be controlled to those with a Henry's law greater than or equal to  $1.8 \times 10^{-6}$  atm m<sup>3</sup>/gmole fraction (0.1 y/x) at 25 °C, which is similar to the cutoff used in the HON. The major factor influencing the Agency selection of compounds to be controlled is biodegradability and the fraction removed by steam stripping. The lower volatility compounds are already significantly biodegraded and are not removed to a significant extent by steam stripping. Therefore, the decision was made to limit control to compounds with a Henry's law greater than or equal to  $1.8 \times 10^{-6}$  atm m<sup>3</sup>/gmole fraction (0.1 y/x) at 25 °C.

The HON clarifies several points that seem to be areas of confusion. The HON discusses point of generation and the different methods of determining the concentration and flow at the point of generation. The point of generation is defined to

be where each individual wastewater stream first exits production process equipment prior to any form of wastewater treatment. The characteristics of a wastewater stream at the point of generation are used to determine which streams to control because this is where the volatile organic concentration is the highest and the flow is the lowest. The use of the point of generation characteristics in this way results in the identification of the most cost effective streams for control. If the characteristics of the streams were determined at some point downstream of the point of generation, there would be losses of organics due to air emissions and an increase in the wastewater flowrate due to mixing with other wastewater streams, both of which would result in the subsequent control of the stream being less cost effective. In addition, if wastewater treatment were allowed before the point of generation, the treatment unit, such as an air stripper, would not be required to have air emission control.

Another area of confusion is in the use of biological treatment units for compliance. For the CTG/ACT desired performance is the same as required by the HON. Appendix C to part 63 explains how to determine the fraction biodegraded in a site specific biological treatment unit. The HON allows use of a biological treatment unit if the unit obtains equivalent control of the required mass removal by the recommended control technology or achieves 95% destruction of the applicable HAP.

### **Reevaluation of Options**

The options table for the Pharmaceutical industry included in the draft IWW CTG represented options for the chemical syntheses subcategory only. At the time we developed this table we considered the wastewater in the fermentation subcategory a relatively high flow with a relatively low VOC concentration. Based on additional data received from the Office of Water 1990 Section 308 Pharmaceutical Manufacturing Survey, we have determined that the wastewater in the fermentation subcategory is high flow and has a higher VOC concentration than previously thought. For this reason, the revised options table reflects the combined analysis of the chemical synthesis and the fermentation subcategories.

Based on the changes made as previously described, the Synthetic Organic Chemicals Manufacturing Industry (SOCMI) Section 114 database was reevaluated to create the OCPSF options table. Adjustments were made in the OCPSF options analysis to account for control the HON will get when it is in place. The pharmaceuticals database was also reevaluated and expanded as discussed earlier, and the changes are reflected in the new options table. Due to time and resource constraints, the databases for Hazardous Waste TSDF and Pesticides were not recalculated with the changes described in this notice and the

options tables attached reflect the assumptions made in the draft IWW CTG.

Appendix A contains the option tables for the four industries for which control is recommended by the IWW CTG/ACT. The OCPSF options table is based on data from the 1990 Clean Air Act Section 114 SOCOMI questionnaire. The Pesticides options table is based on information from the Office of Water Regulations and Standards (OWRS) 1989 Section 308 survey. The Hazardous Waste TSDF options table is based on responses to a 1986 Office of Solid Waste Section 3007 of RCRA survey. The Pharmaceuticals options table is based on the Office of Water 1990 Section 308 Pharmaceutical Manufacturing Survey.

**APPENDIX A**

Options Tables

ORGANIC CHEMICALS, PLASTICS, AND SYNTHETIC FIBERS  
RACT OPTIONS NATIONAL IMPACTS

Option description			VOC emission reducti on (Mg/yr)	Percent VOC emission reductio n	Percent wastewate r flow controlle d	Percent wastewate r stream controlle d	Total annual cost (MM\$/yr)	Average cost effectivene ss (\$/Mg)
VO concentrati on cutoff (ppmw)	Flow rate cutoff (lpm)	Maximum VO concentrati on (ppmw)						
1,000	10	10,000	47,800	43%	8%	8%	18	383
1,000	1	10,000	49,500	45%	9%	15%	20	408
500	10	10,000	61,600	56%	22%	14%	47	760
500	1	10,000	63,400	57%	22%	24%	48	759
200	1	10,000	69,100	62%	30%	30%	66	959
100	1	10,000	70,700	64%	37%	36%	82	1,160
TIC			78,500	71%	100%	100%	194	2,470

Baseline VOC emissions = 110,800 Mg/yr  
Total wastewater volume = 490,000 lpm  
Total number wastewater streams = 7,300  
VOC control by the Hazardous Organic NESHP = 49,800 Mg/yr  
TIC = Total Industry Control

PHARMACEUTICALS SUBCATEGORY A/C (FERMENTATION/CHEMICAL SYNTHESIS)  
RACT OPTIONS NATIONAL IMPACTS

Option description			VOC emission reduction (Mg/yr)	Percent VOC emission reduction	Percent wastewater flow controlled	Percent wastewater stream controlled	Total annual cost (MM\$/yr)	Average cost effectiveness (\$/Mg)
VO concentration cutoff (ppmw)	Flow rate cutoff (lpm)	Maximum VO concentration (ppmw)						
1,000	10	10,000	8,800	74%	14%	35%	5	610
1,000	1	10,000	8,900	75%	14%	40%	6	640
500	10	10,000	9,200	77%	22%	42%	7	750
500	1	10,000	9,300	79%	23%	47%	7	790
200	1	10,000	9,400	79%	31%	62%	9	970
100	1	10,000	9,500	80%	45%	62%	11	1,170
TIC			9,600	81%	100%	100%	20	2,070

Baseline VOC emissions = 11,900 Mg/yr  
Total wastewater volume = 39,100 lpm  
Total number wastewater streams = 540  
TIC = Total Industry Control

PESTICIDES RACT OPTIONS NATIONAL IMPACTS

Option description			VOC emission reduction (Mg/yr)	Percent VOC emission reduction	Percent wastewater flow controlled	Percent wastewater stream controlled	Total capital cost (MM\$)	Total annual cost (MM\$/yr)	Average cost effectiveness (\$/Mg)
VO concentration cutoff (ppmw)	Flow rate cutoff (lpm)	VO maximum concentration (ppmw)							
1,000	10	10,000	1,400	73%	20%	23%	4.4	1.6	1,200
500	10	10,000	1,400	74%	21%	24%	5.1	1.8	1,300
1,000	1	10,000	1,500	78%	22%	35%	5.1	1.9	1,300
500	1	10,000	1,500	79%	24%	37%	5.2	1.8	1,200
200	1	10,000	1,600	83%	43%	48%	7.1	2.5	1,600
100	1	10,000	1,600	84%	49%	57%	7.4	2.7	1,700
TIC			1,600	85%	100%	100%	11	4.7	2,900

Baseline VOC emissions = 1,900 Mg/yr  
 Total wastewater volume = 4,700 lpm  
 Total number wastewater streams = 190  
 TIC = Total Industry Control

TREATMENT, STORAGE, AND DISPOSAL FACILITIES RACT OPTIONS NATIONAL IMPACTS

Option description			VOC emission reduction (Mg/yr)	Percent VOC emission reduction	Percent wastewater flow controlled	Percent wastewater stream controlled	Total capital cost (MM\$)	Total annual cost (MM\$/yr)	Average cost effectiveness (\$/Mg)
VO concentration cutoff (ppmw)	Flow rate cutoff (lpm)	Maximum VO Concentration (ppmw)							
1,000	10	10,000	1,900	61%	9%	18%	3.3	1.7	870
500	10	10,000	1,900	61%	9%	18%	3.3	1.7	870
1,000 <sup>a</sup>	1	10,000	1,900	61%	9%	19%	3.5	1.7	910
500	1	10,000	1,900	61%	9%	20%	3.7	1.8	940
200	1	10,000	2,000	63%	14%	24%	5.2	2.6	1,300
100	1	10,000	2,000	65%	24%	39%	8.3	4.3	2,100
TIC			2,100	66%	100%	100%	22	13	6,200

Baseline VOC emissions = 3,100 Mg/yr  
 Total wastewater volume = 15,000 lpm  
 Total number wastewater streams = 40  
 TIC = Total Industry Control

<sup>a</sup>Previously reported as the 1,000 ppmw/10 lpm option in the CTG document on page B-59.



APPENDIX B

Compound Specific Fe, Fm, Fr

COMPOUND SPECIFIC ESTIMATED Fe, Fm, AND, Fr VALUES

COMPOUND	Fe	25D Fm	Fr 0.04
2,4 D	0.1516	0.1507	0.9569
ACENAPHTHENE	0.8044	1.1106	1.0
0.3121 1.0937 0.9987			
ACETAL	0.4324	0.8128	0.9994
ACETALDEHYDE	0.4847	0.7241	0.953
ACETATE	0.7937	0.93	1.0
ACETIC ACID	0.1004	0.1014	0.066
ACETIC ANHYDRIDE	0.1012	0.15	0.7204
ACETONE	0.1463	0.827	0.8428
ACETONITRILE	0.3588	0.7783	0.6248
ACETOPHENONE	0.1369	0.334	0.7209
ACETYL CHLORIDE	0.3549	0.9232	0.9906
ACETYL DIETHYLMALONATE	0.1331	0.44	0.9437
ACETYLENE	0.58	0.93	1.0
ACETYLFURAN 2	0.3101	0.75	0.9978
ACETYLMETHYLPHTHALATE 4	0.1274	0.0363	0.995
ACIFLUORFEN	0.6008	0.198	1.0
ACROLEIN	0.4271	0.8554	0.9681
ACRYLONITRILE	0.4285	0.8756	0.9688
ADAMANTANE DICARBOXYLIC ACID	0.98	0.93	1.0
ADAMANTANE DICHLORIDE	0.5617	0.93	1.0
AFLATOXINS	0.4057	0.75	0.9997
ALKYLIMINE CARBOXYLIC ACID N,SUB	0.1109	0.44	0.8482
ALLYL ALCOHOL	0.1298	0.5379	0.7728
ALLYL CHLORIDE	0.8865	1.0918	1.0
ALLYL ETHER, diallyl ether	0.6633	0.9735	1.0
alpha-CHLORO-beta-METHYLNAPHTHALENE	0.8277	0.93	1.0
ALPHA-HYDROXYACETALDEHYDE	0.3025	0.75	0.9971
ALPHA-HYDROXYADIPIMIDE	0.1255	0.44	0.9247
ALPHA METHYL STYRENE DIMERS	0.8547	0.93	1.0
ALPHA METHYL STYRENE	0.7669	1.2172	1.0
AMINO-2-CHLOROTOLUENE 4	0.7896	0.93	1.0
AMINO-3-CHLORO-5-PHENYLCYCLOHEXANONE 2	0.0859	0.15	0.6063
AMINO-4-CHLORO-6-CYANOPYRIDINE 2	0.4108	0.75	0.9997
AMINO-4-CHLOROPYRIDINE 2	0.71	0.93	1.0
AMINO-4-NITROBENZYL ALCOHOL 2	0.1016	0.15	0.7283
AMINO-4-NITROTOLUENE 2	0.8023	0.93	1.0
AMINO-5-CHLOROPYRIDINE 2	0.3841	0.75	0.9996
AMINO-p'-METHYLAZOBENZENE P	0.8517	0.93	1.0
AMINOBENZOIC ACID (-p)	0.0863	0.15	0.6085
AMINOCYCLOHEXANE	0.3795	0.75	0.9996

ACENAPHTHYLENE

AMINOMETHYL-3-ISOXAZOLOL 5	0.2648	0.75	0.9954
AMINOPHENOL(-o)	0.0826	0.0338	0.6251
AMINOPHENOL(-p)	0.1338	0.0009	0.2623
AMINOPHENOL,3-	0.5615	0.93	1.0
AMINOPROPIONITRILE 3	0.1091	0.44	0.8316
AMITROLE	0.0855	0.15	0.6026
AMMONIA	0.4198	0.75	0.9998
AMPHETAMINE	0.3227	0.75	0.9986
AMYL ACETATE(-n)	0.4623	0.4261	1.0
ANETHOLE	0.4057	0.75	0.9997
ANTHRACENE	0.98	0.1088	0.9993
ARAMITE	0.4057	0.75	0.9997
AZASERINE	0.1885	0.44	0.9863
AZEPINE	0.8173	0.93	1.0
AZIRIDINE ethylene imine	0.685	0.6287	1.0
BENZ(c)ACRIDINE	0.8527	0.93	1.0
BENZAL CHLORIDE	0.7981	1.159	1.0
BENZALDEHYDE	0.1872	0.5157	0.9803
BENZALKONIUM CHLORIDE	0.0651	0.15	0.3986
BENZENE	0.7974	1.2267	1.0
BENZEN SULFONATE	0.8943	0.93	1.0
BENZETHONIUM CHLORIDE	0.1402	0.44	0.9558
BENZO(B)FLUORANTHENE	0.1348	1.2673	0.057
BENZO(j)FLUORANTHENE	0.8527	0.93	1.0
BENZODIOXANE-1,3	0.0927	0.15	0.6525
BENZOFUORANTHENE,3,4-	0.8527	0.93	1.0
BENZOFURAN 2,3	0.374	1.061	0.9997
BENZONITRILE	0.1194	0.3959	0.9926
BENZOPHENONE	0.8335	0.0524	1.0
BENZOPYRENE 3,4	0.3181	0.75	0.9984
BENZOQUINONE,p-	0.7937	0.93	0.6739
BENZOTHIAZOLE	0.3227	0.75	0.9986
BENZOTRICHLORIDE	0.5581	1.0688	1.0
BENZOYL CHLORIDE	0.3493	1.1321	0.9979
BENZYL CHLORIDE	0.4675	1.1543	0.9995
BENZYL METHYL ETHER	0.98	0.93	1.0
BHC,alpha-	0.8602	0.93	0.8986
BHC,beta-	0.98	0.93	0.8986
BHC,delta-	0.4356	0.75	0.8986
BIPHENYL	0.4454	1.0739	1.0
BIS(1,1,2,2-TETRACHLOROPROPYL) ETHER	0.98	0.9597	1.0
BIS(2-CHLOROETHOXY) METHANE	0.6374	0.93	1.0
BIS(2-CHLOROETHYL)ETHER	0.118	0.8058	0.64
BIS(2-CHLOROISOPROPYL)ETHER	0.3101	0.75	0.9978
BIS(CHLOROMETHYL)ETHER	0.4585	0.8879	0.9746
BISPHENOL(A)	0.665	0.0114	1.0

BROMACIL	0.98	0.5822	1.0
BROMO-(1)-CHLOROETHANE-2	0.98	0.93	1.0
BROMO-3-CHLOROBUTADIENE 2	0.8198	0.93	1.0
BROMO-4-CHLORO-6-CYANOBENZYL ALCOHOL 2	0.1319	0.44	0.9413
BROMO-4-CHLOROCYCLOHEXANE 1	0.98	0.93	1.0
BROMO-4-CYANOMETHYL BENZOATE 3	0.8848	0.93	1.0
BROMO-4-CYANOMETHYL BENZOATE 2	0.98	0.93	1.0
BROMOACETONE	0.7937	0.93	1.0
BROMOBENZENE	0.745	1.1823	1.0
BROMOBENZYL ALCOHOL -(p)	0.0833	0.15	0.5861
BROMOBENZYL ALCOHOL -(o)	0.0833	0.15	0.5861
BROMOBENZYL ALCOHOL -(m)	0.0833	0.15	0.5861
BROMOCHLOROBENZYL ALCOHOL	0.1066	0.15	0.805
BROMOCHLOROMETHANE	0.98	1.0167	1.0
BROMODICHLOROMETHANE	0.98	0.7354	1.0
BROMOETHYL ACETATE	0.453	0.75	0.9999
BROMOETHYLENE	0.98	0.93	1.0
BROMOFORM	0.4943	0.4795	0.9998
BROMOMETHANE	0.8519	0.5392	1.0
BROMOPROPIONITRILE 3	0.8557	0.93	1.0
BROMOTOLUENE 4	0.6758	1.1644	1.0
BUTADIENE-(1,3)	0.9793	1.1867	1.0
BUTANE	0.98	1.0795	1.0
BUTANEDINITRILE	0.1084	0.0071	0.9941
BUTANENITRILE	0.1524	0.44	0.5067
BUTANOL(S)	0.1173	0.5009	0.8458
BUTANOL-1	0.1083	0.5009	0.8127
BUTANOL ISO	0.0679	0.6469	0.8166
BUTENE	0.9261	1.1312	1.0
BUTYL-m-CRESOL MONO T	0.7937	0.93	1.0
BUTYL-p-CRESOL MONO T	0.7937	0.93	1.0
BUTYL ACETATE(-n)	0.3373	0.8079	0.9999
BUTYL ACRYLATE	0.4919	0.7806	0.9999
BUTYLAMINE	0.1262	0.8133	0.9037
BUTYL BENZENE	0.98	1.1809	1.0
BUTYL BENZYL PHTHALATE	0.8522	0.93	1.0
BUTYL CARBITOL	0.98	0.0061	1.0
BUTYLENE GLYCOL-(1,3)	0.0815	0.0026	0.7701
BUTYLISOBUTYRATE	0.7925	0.8732	1.0
BUTYL MERCAPTAN	0.98	0.93	1.0
BUTYRALDEHYDE	0.3846	0.861	0.9892
BUTYRALDEHYDE ISO	0.3287	0.8859	0.9886
CACODYLIC ACID	0.1782	0.44	0.9832
CAMPHENE	0.5883	0.93	1.0
CAPTAN	0.196	0.0073	1.0
CARBARYL sevin	0.2015	0.0146	1.0

CARBENDAZIM	0.0704	0.0234	0.9569
CARBON DISULFIDE	0.9178	0.2133	1.0
CARBON TETRACHLORIDE	0.9404	1.0267	1.0
CARBONYL SULFIDE	0.5385	0.5467	0.8862
CHLORAL	0.5558	0.9375	0.9998
CHLORAMBEN	0.229	0.5446	0.9621
CHLORAMBUCIL	0.1006	0.0314	0.9568
CHLORDANE	0.1512	0.4379	0.9985
CHLORENDIC ANHYDRIDE	0.7937	0.93	1.0
CHLORINATED TARS	0.3428	0.75	0.9992
CHLORNAPHAZINE	0.1582	0.4218	1.0
CHLORO(-p)PHENYLHYDRAZINE	0.3977	0.75	0.9997
CHLORO-1,3-CYCLOPENTADIENE 5	0.9482	0.93	1.0
CHLORO-2,2-DIBROMOETHANE 1	0.5265	0.93	1.0
CHLORO-2,3-EPOXYPROPANE,1-	0.1636	0.44	0.9769
CHLORO-2-METHOXYBENZOIC ACID 4	0.7217	0.93	1.0
CHLORO-2-NITROBENZYL ALCOHOL 4	0.0833	0.15	0.5861
CHLORO-3-NITRO-5-PHENYLCYCLOHEXANE 2	0.0872	0.15	0.6159
CHLORO-3-NITROANILINE 4	0.3418	0.75	0.9991
CHLORO-4-CYANOBENZYL ALCOHOL 2	0.1017	0.15	0.7301
CHLORO-4-METHOXY-6-AMINOBENZOIC ACID 2	0.4494	0.75	0.9998
CHLORO-4-METHYL-N-METHYLBENZAMIDE 3	0.1089	0.44	0.8297
CHLORO-4-PHENYLPYRIDINE 2	0.1097	0.44	0.8377
CHLORO-5-CYANOTOLUENE 3	0.6008	0.93	1.0
CHLORO-5-FLUOROTOLUENE 3	0.4002	0.75	0.9997
CHLORO-5AMINO3PYRIDINE CARB.ACID AMIDE 2	20.439	0.75	0.9998
CHLORO-N-METHYLBENZAMIDE P	0.1073	0.15	0.8128
CHLORO-p'-METHYLBIPHENYL P	0.8505	0.93	1.0
CHLORO-p-XYLENE	0.5925	0.93	1.0
CHLORO 2 BUTENE,1 trans	0.6317	1.0981	1.0
CHLOROACETALDEHYDE	0.1487	0.8549	0.7496
CHLOROALLYL ALCOHOL 2	0.1305	0.2736	0.9272
CHLOROANILINE(2)	0.8669	0.2451	1.0
CHLOROANILINE(3)	0.8669	0.1084	1.0
CHLOROAZOBENZENE	0.8522	1.2042	1.0
CHLOROBENZENE	0.7277	1.157	1.0
CHLOROBENZENESULFONIC ACID (-p)	0.1081	0.15	0.8219
CHLOROBENZILATE	0.0295	0.0001	0.876
CHLOROBENZOIC ACID,2	0.1049	0.15	0.7821
CHLOROBENZOTRIFLUORIDE, P	0.98	1.2234	1.0
CHLOROBENZYL ALCOHOL -(p)	0.0744	0.15	0.5059
CHLOROBENZYL ALCOHOL -(o)	0.0744	0.15	0.5059
CHLOROBENZYL ALCOHOL -(m)	0.0744	0.0277	0.8688
CHLOROBIPHENYL (-p)	0.8396	0.93	1.0
CHLOROBUTADIENE,1	0.8502	1.1237	1.0
CHLOROCOUMARAN 2	0.8319	0.93	1.0

CHLOROCYCLOHEXANE	0.98	0.93	1.0
CHLOROCYCLOHEXANOL 2	0.3901	0.75	0.9997
CHLOROCYCLOHEXANOL 4	0.5875	0.93	1.0
CHLORODIPHENYL THIOETHER P	0.8507	0.93	1.0
CHLOROETHANE (ethyl chloride)	0.9008	1.0462	1.0
CHLOROETHANOL (ETHYLENE CHLOROXYDRIN) 2	0.1123	0.44	0.8596
CHLOROETHYL(2-) VINYL ETHER	0.9105	0.93	1.0
CHLOROETHYLENE	0.7571	1.0641	1.0
CHLOROFLUOROMETHANE	0.98	0.93	1.0
CHLOROFORM	0.775	1.0233	1.0
CHLOROMETHYL ACETYLENE	0.98	0.93	1.0
CHLOROMETHYLAMINOIMINE	0.9134	0.93	1.0
CHLOROMETHYL ETHYL KETONE	0.6967	0.93	1.0
CHLOROMETHYL METHYL ETHER	0.4943	0.8395	0.9369
CHLOROMETHYL PHENYL KETONE	0.0768	0.15	0.5294
CHLOROMETHYL PHENYLHYDRAZINE P	0.4128	0.75	0.9998
CHLORONAPHTHALENE, 2-	0.8703	1.1768	0.6739
CHLORONITROALKOXYIMINE	0.1416	0.44	0.9578
CHLORONITROBENZENE (-o)	0.8079	0.5189	1.0
CHLORONITROBENZENE, p	0.3007	0.5914	0.9964
CHLOROPHENOL-2	0.1068	0.2441	0.3182
CHLOROPHENOL-3	0.0784	0.0573	0.6192
CHLOROPHENYLETHANOL 1,1	0.8069	0.93	1.0
CHLOROPHENYL PHENYL ETHER, 4-	0.3656	0.75	0.9995
CHLOROPHTHALIC ANHYDRIDE 4	0.0826	0.15	0.5805
CHLOROPRENE	0.6765	1.1237	0.9977
CHLOROPROPANE-1	0.8576	1.0546	1.0
CHLOROPROPANE-2	0.8674	1.0501	1.0
CHLOROPROPENE 3	0.98	1.0918	1.0
CHLOROPROPIONITRILE, 3-	0.0965	0.5798	0.3523
CHLOROPROPYLENE-2	0.98	1.0902	1.0
CHLOROPYRIDINE 2	0.5992	0.93	1.0
CHLOROSTYRENE (-4)	0.7881	0.93	1.0
CHLOROTETRAHYDROFURAN 3	0.4072	0.75	0.9997
CHLOROTOLUENE-4	0.7408	1.1644	1.0
CHROMIUM (TOTAL)	0.4057	0.75	0.9997
CROTONALDEHYDE	0.1236	0.8871	0.5599
CROTONYLENE	0.98	0.93	1.0
CUMENE (isopropylbenzene)	0.8761	1.1973	1.0
CUMENE HYDROPEROXIDE	0.161	0.4776	0.9865
CYANOBENZYL ALCOHOL P	0.0697	0.15	0.4552
CYANOGEN	0.7471	0.8	1.0
CYANOGEN BROMIDE	0.98	0.93	0.7231
CYANOGEN CHLORIDE	0.6997	0.93	0.6739
CYANOQUANIDINE	0.6483	0.93	1.0
CYANURIC ACID	0.0717	0.15	0.4775

CYCASIN	0.7937	0.93	1.0
CYCLOHEXANE	0.8593	1.0933	1.0
CYCLOHEXANOL	0.0907	0.2415	0.9249
CYCLOHEXANONE	0.0872	0.7033	0.1963
CYCLOHEXENE	0.98	0.93	1.0
CYCLOHEXYL-2,2-DIPHENYLETHYLAMINE 2	0.3841	0.75	0.9996
CYCLOHEXYL ACETATE	0.2553	0.75	0.9949
CYCLOHEXYLAMINE	0.1872	0.8783	0.9777
CYCLOHEXYLCYCLOHEXANONE 4	0.7275	0.93	1.0
CYCLOPENTADIENE	0.98	1.1984	1.0
CYCLOPENTADIENE 1,3	0.7127	0.93	1.0
CYCLOPHOSPHAMIDE	0.6096	0.93	1.0
CYTOSINE	0.7181	0.93	1.0
DAUNOMYCIN	0.8527	0.93	1.0
DAZOMET	0.0665	0.0848	0.9001
DDD,p,p'-	0.138	0.44	0.8234
DDE,p,p'-	0.6211	1.1382	1.0
DDT	0.98	1.1311	1.0
DI-n-OCTYL PHTHALATE	0.98	0.0001	1.0
DI-tert-BUTYL-p-CRESOL	0.7937	0.93	1.0
DIACETYL	0.2908	0.75	0.9965
DIAMINO-5-SULFONYL BENZYL 2,4	0.6275	0.93	1.0
DIAZINON	0.087	0.15	0.6739
DIAZOMETHANE	0.3556	0.573	0.5576
DIBENZOFURANS	0.7399	1.112	1.0
DIBENZOPYRENE 1,2,7,8	0.7196	0.8033	1.0
DIBROMO-3-CHLOROPROPANE,1,2	0.185	1.0476	0.6934
DIBROMOCHLOROMETHANE	0.5265	0.5851	0.4124
DIBROMOETHANE-1,2	0.8524	1.1142	1.0
DIBROMOMETHANE	0.5582	0.4926	0.9997
DIBUTYL ETHER	0.7271	0.93	1.0
DICHLORO-2-BUTENE(1,4)	0.3851	1.0789	0.9986
DICHLORO-2-BUTENE, 1,4	0.6125	1.0789	1.0
DICHLORO-2-BUTENE 1,2	0.5577	1.0789	0.9999
DICHLORO-TRANS-ETHYLENE(1,2)	0.98	0.93	1.0
DICHLORO 2-PROPANOL 1,3	0.4615	0.2371	1.0
DICHLOROANILINE(2,3)	0.0641	0.1205	0.5118
DICHLOROBENZENE(1,2) (-o)	0.6367	1.1341	1.0
DICHLOROBENZENE(1,3) (-m)	0.719	0.93	1.0
DICHLOROBENZENE(1,4) (-p)	0.7241	1.1341	1.0
DICHLOROBENZIDINE,3,3'-	0.026	0.0545	0.0005
DICHLOROBENZOPHENONE P,P	0.0934	0.3663	0.9779
DICHLOROBIPHENYL (PARA)	0.9139	0.93	1.0
DICHLOROBUTANE (1,4)	0.98	0.93	1.0
DICHLORODIPHENYLMETHANE	0.8549	0.93	1.0
DICHLOROETHANE(1,1) ethylidenedichloride	0.7915	1.0243	1.0

DICHLOROETHANE (1,2)	0.6398	1.04	0.9999
DICHLOROETHENE (1,1) vinylidene chloride	0.9374	1.0609	1.0
DICHLOROETHENE 1,2 trans	0.9808	1.0609	1.0
DICHLOROETHYLENE (1,2) cis	0.9042	1.0609	1.0
DICHLOROETHYL ETHER	0.2116	0.7111	0.8721
DICHLOROMONOFLUOROMETHANE	0.98	1.0233	1.0
DICHLOROPHENOL	0.2057	0.9404	0.9983
DICHLOROPHENOL (2,4)	0.094	0.1575	0.945
DICHLOROPHENOL (2,6)	0.094	0.2134	0.8471
DICHLOROPHENOXYACETIC ACID (2,4)	0.9778	0.9222	1.0
DICHLOROPROPANE 1,2	0.7205	1.0536	1.0
DICHLORO PROPANOL 2,3	0.1426	0.1193	0.4909
DICHLOROPROPENE (1,3)	0.7592	1.071	1.0
DICHLOROPROPYLENE, 1,2- (trans)	0.8527	1.0722	1.0
DICHLOROPROPYLENE, 1,2- (cis)	0.8319	1.0617	0.9724
DICHLOROPROPYLENE-2,3	0.8573	0.93	1.0
DICHLOROSTYRENE 2,6	0.8229	0.93	1.0
DIELDRIN	0.2253	0.2587	1.0
DIETHYL AMINE	0.796	0.8652	1.0
DIETHYLBENZENE P	0.7835	1.1908	1.0
DIETHYLDIPHENYL UREA SYM	0.8586	0.93	1.0
DIETHYLENE GLYCOL DIETHYL ETHER	0.0334	0.1684	0.3106
DIETHYL ETHER	0.3881	0.8556	0.9999
DIETHYL ETHER ACID CHLORIDE	0.98	0.93	1.0
DIETHYL PHTHALATE	0.8529	0.93	1.0
DIETHYL SULFATE	0.1065	0.0013	0.9092
DIETHYLUREA 1,1	0.1009	0.15	0.7152
DIHYDRO-5-OXAZALONE (DIHYDROAZLACTONE)	0.7224	0.93	1.0
DIISOBUTYLENE	0.98	1.1269	1.0
DIISODECYL PHTHALATE	0.451	0.0072	1.0
DIISOPROPYLAMINE	0.4093	0.9393	0.9998
DIISOPROPYL BENZENE (PARA)	0.98	1.1838	1.0
DIISOPROPYL KETONE	0.4832	0.9726	0.9999
DIMETHOXY-(3,3')-BENZIDINE	0.66	0.0002	1.0
DIMETHOXY METHANE	0.3156	0.75	0.9982
DIMETHYL-1-NITROBENZENE 2,4	0.8012	0.93	1.0
DIMETHYLACETAMIDE	0.1113	0.707	0.5323
DIMETHYL AMINE	0.0984	0.7086	0.3149
DIMETHYL BENZ(A)ANT 7,12	0.8569	1.2139	1.0
DIMETHYL BENZYLAMINE N,N	0.5875	0.0055	1.0
DIMETHYLBENZYL HYDROPEROXIDE	0.4657	0.75	0.9999
DIMETHYLETHYLAMINE	0.4464	0.8653	1.0
dimethylaniline N,N	0.3424	0.0004	0.9999
DIMETHYL METHYLTHIOCARBAMATE N,N	0.8626	0.93	1.0
DIMETHYL NITROISOPROPYLAMINE N,N	0.3886	0.75	0.9996
DIMETHYLPHENOL (2,4)	0.5517	0.0496	0.5532



DIMETHYLPHENYLCARBINOL	0.7937	0.93	1.0
DIMETHYL SULFATE	0.0788	0.0342	0.5329
DIMETHYL SULFIDE	0.8291	0.5079	1.0
DIMETHYLSULFOXIDE	0.1972	0.8214	0.8533
DINITROBENZENE M	0.1392	0.5641	0.0227
DINITROPHENOL 2,4	0.0595	0.004	0.9964
DINITROTOLUENE (2,4)	0.1776	0.0517	0.3811
DINITROTOLUENE 2,6	0.1088	0.0	0.9965
DINOSEB	0.575	0.93	0.9965
DIOXANE (1,4)	0.1814	0.6185	0.3778
DIOXIN	0.2792	0.75	0.996
DIPHENYLAMINE	0.0737	0.15	0.4987
DIPHENYLBUTADIENE 1,3	0.6467	0.93	1.0
DIPHENYLCHLOROMETHANE	0.8505	0.93	1.0
DIPHENYLDIKETONE	0.8515	0.93	1.0
DIPHENYLETHANE 1,1	0.5508	0.93	1.0
DIPHENYLETHANOL 1,1	0.0657	0.15	0.4064
DIPHENYL ETHER	0.6617	0.93	1.0
DIPHENYLHYDRAZINE,1,1-	0.7958	0.93	0.9988
DIPHENYLMETHANE	0.173	0.6277	1.0
DIPHENYL THIOETHER	0.8377	0.93	1.0
DIPROPYLAMINE	0.3821	0.9267	0.9788
DIPROPYLBUTRAL	0.2922	0.6217	0.9986
DIPROPYLFORMAMIDE	0.98	0.93	1.0
DIVINYL KETONE	0.4571	0.75	0.9999
EDTA	0.4057	0.75	0.9997
ENDOSULFAN	0.1021	0.02	0.8999
EPICHLOROHYDRIN	0.3502	0.8472	0.9145
EPOXYBUTANE 1,2	0.5819	0.8786	0.9991
ETHANE	0.9465	1.0667	1.0
ETHANOL	0.1589	0.5859	0.6739
ETHOXYETHANOL-2	0.1023	0.1441	0.5302
ETHYL(2) HEXANOL	0.2331	0.2563	0.9957
ETHYL-(2)-PROPYL-(3) ACROLEIN	0.1636	0.44	0.9769
ETHYLACETATE	0.3191	0.7224	0.7462
ETHYL ACETATE PEROXIDE	0.7062	0.93	1.0
ETHYL ACRYLATE	0.4833	0.7878	0.9995
ETHYLAMINE	0.148	0.7105	0.5532
ETHYLBENZENE	0.8276	1.204	1.0
ETHYL CYANIDE (PROPIONITRILE)	0.3931	0.75	0.9997
ETHYLENE	0.98	1.1867	1.0
ETHYLENE DIAMINE	0.1072	0.0343	0.9159
ETHYLENE DIBROMIDE	0.565	0.5371	0.9999
ETHYLENE GLYCOL DIMETHYL ETHER	0.3161	0.6012	0.9045
ETHYLENE GLYCOL MONOMETHYL ETHER ACETATE	0.0482	0.0545	0.2807
ETHYLENE GLYCOL MONOBUTYL ETHER ACETATE	0.0674	0.0306	0.7604

ETHYLENE GLYCOL MONOMETHYL ETHER ACETATE	0.0678	0.15	0.4331
ETHYLENE OXIDE	0.5026	0.7117	0.986
ETHYL ETHER	0.5057	0.8556	0.9993
ETHYLHEXYLACRYLATE, 2-	0.705	0.9249	1.0
ETHYL ISOPROPYL PEROXIDE	0.3856	0.75	0.9996
ETHYL S,S-DIPHENYL PHOSPHORODITHIOATE O	0.3327	0.75	0.9989
ETHYL VINYL ETHER	0.6525	0.8896	0.9999
FENCHONE, d-	0.4057	0.75	0.8011
FLUORANTHENE	0.98	0.0487	1.0
FLUORENE	0.3136	0.75	0.9981
FLUOROURACIL, 5-	0.4057	0.75	0.9997
FREON 11, fluorotrichloromethane	0.9548	1.0534	1.0
FREON 12, dichlorodifluoromethane	0.98	1.0592	1.0
FREON 12 DICHLORODIFLUOROMETHANE	0.98	1.0592	1.0
FREONS	0.98	0.93	1.0
FURAN	0.755	0.9833	1.0
FURFURAL	0.279	0.2877	0.9983
FUROIC ACID	0.4798	0.93	0.9999
GEOSMIN	0.4057	0.75	0.9997
GLYOXAL	0.113	0.4899	0.4875
GUANINE	0.98	0.93	1.0
HEPTACHLOR	0.6473	0.6189	1.0
HEPTACHLOR EPOXIDE	0.1619	0.44	0.9759
HEPTANE (-n)	0.98	1.0853	1.0
HEPTANE ISO	0.98	1.0987	1.0
HEXACHLOROBENZENE	0.643	1.0467	1.0
HEXACHLOROBUTADIENE	0.8555	0.9373	1.0
HEXACHLOROCYCLOHEXANE (GAMMA ISOMER)	0.1057	0.1405	0.9987
HEXACHLOROCYCLOPENTADIENE	0.8026	0.8864	1.0
HEXACHLOROETHANE	0.8518	0.5153	1.0
HEXACHLOROPENTADIENE	0.8595	0.93	1.0
HEXADECANE N	0.98	0.93	1.0
HEXAFLUOROACETONE	0.98	0.9681	1.0
HEXAMETHYLENEDIAMINE	0.1552	0.44	0.9714
HEXANE (-n)	1.0	1.084	1.0
HEXANOL-1	0.1303	0.3219	0.8596
HEXEN-2-ONE 5	0.2764	0.8861	0.9788
HHHB	0.7558	0.93	1.0
HHHB	0.7558	0.93	1.0
HHLB	0.8992	0.93	1.0
HHLB	0.8992	0.93	1.0
HHMB	0.5733	0.93	1.0
HHMB	0.5733	0.93	1.0
HYDROFLUORIC ACID	0.374	0.75	0.9996
HYDROGEN SULFIDE	0.8821	0.3333	1.0
HYDROXY-1,3-CYCLOPENTADIENE 5	0.7281	0.93	1.0

HYDROXY-4-METHYLTETRAHYDROFURAN 3	0.3846	0.75	0.9996
HYDROXY-5-METHYLDIMETHYL PHTHALATE 4	0.98	0.93	1.0
HYDROXY6METHYLPYRIDINE3CARBOXYLIC ACID 20.4087	0.3503	0.75	0.9997
HYDROXYACETIC ACID	0.0872	0.0003	0.7482
HYDROXYCYCLOHEXANONE 4	0.8735	0.15	0.6159
HYDROXY DIMETHYL ETHER	0.98	0.93	1.0
HYDROXYDIMETHYL PHTHALATE 4	0.98	0.93	1.0
HYDROXYMETHYL, N-METHYLETHYL AMINE N	0.98	0.93	1.0
HYDROXYMETHYL-N-CHLOROMETHYLETHYLAMINE N0.98	0.98	0.93	1.0
HYDROXYMETHYL ACETYLENE	0.6625	0.93	1.0
HYDROXYMETHYL ISOPROPYL KETONE	0.1241	0.44	0.9201
HYDROXYMETHYLPHENYL CARBAMATE N	0.7896	0.93	1.0
HYDROXYMETHYLTHIOBENZENE	0.9053	0.93	1.0
HYDROXYMETHYLVINYL ETHER	0.45	0.75	0.9999
HYDROXPENTANE 3			
ISOBUTYLENE	0.9156	1.1409	1.0
ISODECANOL	0.0993	0.1649	0.9315
ISOPHORONE	0.1077	0.5249	0.6005
ISOXAZOLOL, 5-(AMINOMETHYL)-3-	0.98	0.93	1.0
LINDANE hexachlorocyclohexane	0.7035	1.0633	1.0
MERCURY	0.8537	0.93	1.0
METHACRYLIC ACID	0.1139	0.0682	0.9945
METHANE	0.98	1.0667	1.0
METHANETHIOL	0.7308	0.93	1.0
METHANOL	0.168	0.4331	0.3114
METHAPYRILENE	0.98	0.93	0.9976
METHOXYACETONITRILE	0.3443	0.75	0.9992
METHOXYCHLOR	0.3332	0.0848	1.0
METHYL-1,3-CYCLOPENTADIENE 5	0.9239	0.93	1.0
METHYL-2,3,4-TRIHYDROQUINOLINE N	0.1217	0.44	0.9115
METHYL-2-AMINOETHYLAMINE	0.8711	0.93	1.0
METHYL-2-HYDROXYETHYLAMINE	0.0805	0.15	0.5629
METHYL-3-ACETYLCYCLOPENTADIENE 1	0.7542	0.93	1.0
METHYL-3-NITROBENZYL ALCOHOL 4	0.1031	0.15	0.7553
METHYL-4-NITROBENZYL ALCOHOL 2	0.0793	0.15	0.5524
METHYL-p'-METHYLTRIPHENYL PHOSPHINE P	0.8615	0.93	1.0
METHYL-PHENYLETHYLAMINE N	0.5875	0.93	1.0
METHYL-TERTIARY-BUTYL ETHER	0.5732	0.9105	0.9993
METHYL-TRIHYDRO-1,3-THIAZOLE 4	0.3076	0.75	0.9976
METHYL 1-PENTENE 2	0.98	1.1251	1.0
METHYL ACETATE	0.306	0.5901	0.9888
METHYLACETONITRILE 2 acetone cyanohydrin0.98	0.98	0.93	1.0
METHYL AMINE	0.7558	0.5158	1.0
METHYL AZIRIDINE 2	0.1619	0.8383	0.8991
METHYL BENZYL ALCOHOL 4	0.1201	0.0581	0.9169

METHYL BIPHENYL (-p)	0.8192	0.93	1.0
METHYL CHLORIDE	0.8404	1.04	1.0
METHYL CHLOROACETAMIDE N	0.1128	0.44	0.8631
METHYL CHOLANTHRENE 3	0.3222	1.234	0.9992
METHYL COUMARAN 2	0.8106	0.93	1.0
METHYL CYCLOHEXANE	0.98	1.1069	1.0
METHYLENE CHLORIDE, dichloromethane	0.77	1.0167	1.0
METHYL ETHER dimethyl ether	0.71	0.6984	1.0
METHYL ETHYL KETONE, 2 butanone	0.4769	0.872	0.9582
METHYL FORMATE	0.98	0.5353	1.0
METHYLFURAN 2	0.0733	0.15	0.4946
METHYL IODIDE	0.7114	0.3544	1.0
METHYL ISOAMYL KETONE	0.3181	0.75	0.9984
METHYLISOBORNEOL, 2-	0.7937	0.93	1.0
METHYL ISOBUTYL KETONE	0.5289	0.9332	0.9997
METHYL ISOCYANATE	0.8702	0.2715	1.0
METHYL ISOPROPYL KETONE	0.4611	0.9222	0.9863
METHYL MERCAPTAN	0.7187	0.3333	0.9999
METHYL METHACRYLATE	0.3657	0.8011	0.9862
METHYL METHANESULFONATE	0.3247	0.75	0.9987
METHYL MORPHOLINE	0.0784	0.3663	0.424
METHYL NAPHTHALENE (1-)	0.5118	1.2036	1.0
METHYL NAPHTHALENE (2-)	0.2243	1.2193	0.9935
METHYLPHENYL CARBAMATE N	0.1203	0.44	0.9057
METHYL PROPENE 2	0.98	0.93	1.0
METHYLSTYRENE (-4)	0.7669	1.2172	1.0
METHYL TETRAHYDROFURAN 2	0.8791	0.93	1.0
METHYL THIOURACIL	0.7531	0.93	1.0
METHYLTIN TRICHLORIDE	0.0699	0.15	0.4575
MHHB	0.248	0.75	0.9944
MHHB	0.248	0.75	0.9944
MHLB	0.1397	0.44	0.9551
MHLB	0.1397	0.44	0.9551
MHMB	0.1837	0.44	0.985
MHMB	0.1837	0.44	0.985
MONOCHLORODIFLUOROMETHANE	0.98	1.0233	1.0
MORPHOLINE	0.2227	0.148	0.9994
MUSTARD GAS	0.4057	0.75	0.8234
NAPHTHALENE	0.5063	1.2388	1.0
NAPHTHOQUINONE-1,4	0.1418	0.44	0.9581
NICKEL CYANIDE	0.2182	0.75	0.9916
NITROANILINE P	0.369	0.0001	1.0
NITROBENZENE	0.2281	0.3052	0.8008
NITROBENZENESULFONYL CHLORIDE P	0.4581	0.75	0.9999
NITROBENZYL ALCOHOL P	0.3559	0.75	0.9994
NITROBIPHENYL, 4-	0.0752	0.0437	0.9759

NITROCELLULOSE	0.5583	0.93	1.0
NITROGEN MUSTARD N-OXIDE	0.7937	0.93	1.0
NITROMETHANE	0.8833	0.2544	1.0
NITRO m XYLENE, 2	0.4549	0.7789	0.9999
NITROPROPANE 2	0.4369	0.5309	0.9845
NITROBENZYL ALCOHOL 4	0.1191	0.44	0.9005
NITROSODI-n-PROPYLAMINE N	0.7115	0.93	1.0
NITROTOLUENE (-p)	0.451	0.3392	1.0
NITROTOLUENE, m	0.2489	0.4754	0.9929
NITROTOLUENE, o	0.295	0.5342	0.9956
NITROTOLUENE, o	0.295	0.5342	0.9956
NONANOL, n	0.0914	0.0993	0.856
NONYLPHENOL	0.7937	0.93	1.0
OCTANE	0.98	1.0863	1.0
OCTANOL 1	0.1898	0.1844	0.9992
OCTANOL 2	0.1151	0.3814	0.9828
OCTANOL 3	0.1039	0.5136	0.995
OCTANOL 4	0.1093	0.4456	0.991
OIL (decane)	0.9511	1.0877	1.0
OXAMIC ACID	0.2976	0.75	0.9967
PARABROMOPHENOL	0.1257	0.44	0.9252
PARAFORMALDEHYDE	0.5583	0.93	1.0
PARALDEHYDE	0.174	0.7174	0.7874
PCB'S (Aroclors)	0.5068	1.1422	1.0
PENTACHLOROBENZENE	0.7958	1.0908	1.0
PENTACHLOROETHANE	0.8772	0.9912	1.0
PENTACHLORONITROBENZENE	0.4049	0.7739	1.0
PENTACHLOROPHENOL	0.2977	0.092	0.6735
PENTADIENE 1,2	0.8539	1.1908	1.0
PENTAERYTHRITOL TETRANITRATE	0.1619	0.44	0.9759
PERYLENE	0.8527	0.93	1.0
PHENANTHRENE	0.7698	0.93	1.0
PHENOL, 3-(1,1-DIMETHYLETHYL)-	0.7937	0.93	1.0
PHENOTHIAZINE	0.8745	0.93	1.0
PHENYLACETIC PEROXIDE	0.1232	0.44	0.9168
PHENYLCYCLOHEXANONE 4	0.826	1.0286	1.0
PHENYLHYDRAZINE	0.3091	0.75	0.9978
PHENYL ISOCYANATE	0.8549	0.93	1.0
PHENYLPHENOL P	0.7104	0.001	1.0
PHENYLTHIOUREA	0.8634	0.93	1.0
PHOSGENE (decomposes)	0.8716	0.8683	1.0
PHOSPHINE	0.9957	0.2133	1.0
PHTHALIC ACID	0.8581	0.7138	1.0
PHTHALIMIDE	0.8537	0.8491	1.0
PICOLINE (2-)	0.3186	0.75	0.9984
PINENE (alpha-)	0.8899	1.1654	1.0

PIPERAZINE	0.187	0.0307	0.9999
POLYCYCLIC KETONE O	0.9482	0.93	1.0
PROPANE	0.8796	1.0752	1.0
PROPANOIC ACID	0.0642	0.1054	0.1035
PROPANOL	0.0645	0.305	0.1827
PROPANOL ISO	0.1227	0.7399	0.7127
PROPENE	0.9301	1.1438	1.0
PROPIONALDEHYDE	0.4062	0.8127	0.9959
PROPIONIC ACID	0.2024	0.0656	0.9991
PROPIONITRILE	0.3931	0.75	0.9997
PROPYL(-n) ACETATE	0.4027	0.7729	0.9993
PROPYL(-n) BENZENE	0.781	1.1911	1.0
PROPYL ACETATE ISO	0.4143	0.7864	0.9982
PROPYL AMINE ISO	0.4349	0.8112	1.0
PROPYLENE	0.98	1.1438	1.0
PROPYLENE CHLOROXYDRIN	0.0694	0.3377	0.2712
PROPYLENE OXIDE	0.6005	0.8408	0.998
PROPYLENIMINE 1,2 2 methyl aziridine	0.2393	0.7925	0.5936
PROPYL ETHER ISO	0.6617	0.9393	1.0
PROPYL THIOURACIL	0.9215	0.93	1.0
PROPYN-1-OL 2 (PROPARLGYL)	0.1075	0.2717	0.5351
PYRIDINE	0.143	0.6081	0.9556
QUINALDINE	0.8527	0.93	1.0
RESERPINE	0.6483	0.93	1.0
SAFROLE	0.4057	0.75	0.9997
SILVEX	0.7735	1.1055	1.0
SODIUM DODECYLBENZENE SULFONATE	0.1208	0.44	0.9077
SODIUM DODECYL SULFATE	0.1949	0.44	0.9878
STYRENE	0.8004	1.2286	1.0
STYRENE OXIDE	0.3409	0.8831	0.9974
SULFIDE	0.6486	0.93	1.0
TAMARON (METHAMIDIPHOS)	0.0906	0.4303	0.3018
TERPINEOL, ALPHA	0.4728	1.0083	1.0
TETRACHLOROBENZENE (1,2,4,5)	0.7325	1.1006	1.0
TETRACHLOROBENZENE (1,2,3,5)	0.7325	1.1006	1.0
TETRACHLOROBENZENE (1,2,3,4)	0.7	1.1006	1.0
TETRACHLORODIBENZO-p-DIOXIN (2,3,7,8)	0.1729	0.1089	1.0
TETRACHLORODIBENZOFURAN (2,3,7,8)	0.3317	0.75	0.9989
TETRACHLOROETHANE (1,1,2,2)	0.4586	1.0152	0.9984
TETRACHLOROETHANE (1,1,1,2)	0.6417	0.93	1.0
TETRACHLOROETHENE	0.9173	1.0483	1.0
TETRACHLOROPHENOL (2,3,5,6)	0.98	0.0104	1.0
TETRACHLOROPHENOL (2,3,4,6)	0.0913	1.0242	0.5771
TETRACHLOROPROPENE (1,1,2,3)	0.831	0.93	1.0
TETRAETHYLENE GLYCOL	0.1175	0.44	0.8923
TETRAETHYL LEAD	0.98	0.9505	1.0

TETRAETHYLPYROPHOSPHATE	0.98	0.93	0.6739
TETRAFLUOROMETHANE	0.98	1.0374	1.0
TETRAHYDROFURAN	0.2031	0.8602	0.8274
TETRAHYDRONAPHTHALENE,1,2,3,4-	0.7937	0.93	0.8873
TETRALIN	0.6317	1.1894	1.0
TETRANITROMETHANE	0.8517	0.2667	0.6739
THIOACETAMIDE	0.3229	0.75	0.9986
THIOBENZYL ALCOHOL P	0.1165	0.44	0.8873
THIOCYANATE (TOTAL AS SCN-)	0.8943	0.93	1.0
THIOMETHANOL	0.4739	0.75	0.9999
THIOPHENOL	0.933	0.93	0.6438
THIOPROPIONAMIDE 2	0.0975	0.15	0.6812
THIOUREA	0.3352	0.0106	0.8926
THYMINE	0.8062	0.93	1.0
TOLUENE	0.8044	1.2149	1.0
TOLUENE24DIAZOBIS-METATOLUENEDIAMINE HCl	0.1884	0.44	0.9863
TOLUENESULFONYL CHLORIDE	0.0681	0.046	0.5887
TOLUIC ALDEHYDE	0.3821	0.5133	1.0
TOLUIDINE (-0)	0.0523	0.1591	0.4459
TOLUIDINE P	0.1324	0.2741	0.8496
TOXAPHENE	0.7354	0.0536	0.9998
TRIBUTYL PHOSPHOROTRITHIOATE SSS	0.3337	0.0	0.9992
TRIBUTYL TIN ACETATE	0.7887	0.929	1.0
TRICHLORO-1,2,2-TRIFLUOROETHANE,1,1,2-	0.98	1.0333	0.6739
TRICHLORO-1,3,5-TRIAZINE 2,4,6	0.5518	0.93	1.0
TRICHLOROANISOLE 2,3,6	0.98	0.93	1.0
TRICHLOROBENZENE 1,2,4	0.6371	1.1142	1.0
TRICHLOROBENZENE 1,2,3	0.8077	1.1142	1.0
TRICHLOROBENZENE 1,3,5	0.8769	1.1142	1.0
TRICHLOROBUTANE 1,2,3	0.98	0.93	1.0
TRICHLOROETHANE 1,1,2	0.5974	1.0253	0.9999
TRICHLOROETHANE 1,1,1 methyl chloroform	0.9129	1.0371	1.0
TRICHLOROETHYLENE	0.8661	1.0528	1.0
TRICHLOROFLUOROMETHANE	0.9685	1.0267	1.0
TRICHLOROPHENOL 2,4,6	0.1666	0.1349	0.9993
TRICHLOROPHENOL 2,4,5	0.0864	0.1108	0.9636
TRICHLOROPROPANE(1,1,2)	0.8968	1.0371	1.0
TRICHLOROPROPANE(1,2,3)	0.8943	1.0477	1.0
TRICHLOROPROPANE(1,2,2)	0.8968	1.0465	1.0
TRICHLOROPROPANE 1,1,1	0.8968	1.0477	1.0
TRICHLOROPROPENE (1,1,2)	0.7952	0.93	1.0
TRICOSANE N	0.3011	0.75	0.9969
TRIETHYLAMINE	0.3793	0.9301	0.9992
TRIETHYLENE GLYCOL	0.1106	0.44	0.8458
TRIETHYLPHOSPHOROTHIOATE,o,o,o-	0.7937	0.93	0.9892
TRIFLUOROETHANE (1,1,1)	0.98	1.0585	1.0

TRIFLURALIN	0.2909	0.0857	1.0
TRIIISOBUTYLENE	0.98	1.1165	1.0
TRIIISOPROPYLAMINE	0.7152	1.0258	1.0
TRIMELLITIC ANHYDRIDE	0.087	0.15	0.6137
TRIMETHYL-4-NITROANILINE 2,3,5	0.8312	0.93	1.0
TRIMETHYLAMINE	0.5845	0.93	1.0
TRIMETHYLBENZENE (1,3,5)	0.98	1.1997	1.0
TRIMETHYL BENZENE, 123	0.8532	1.1997	1.0
TRIMETHYLPENTANE 2,2,4	1.0	1.1162	1.0
TRINITROBENZENE, sym-	0.7122	0.93	1.0
TRINITROTOLUENE(2,4,6)	0.1196	0.0044	0.2212
TRIPHENYL PHOSPHINE	0.3206	0.75	0.9985
TRIPHENYLPHOSPHINE NICKEL CARBONYL	0.7223	0.93	1.0
TRIS (1-AZIRIDINYL) PHOSPHINE SULFIDE	0.3787	0.75	0.9996
TRIS (2,3-DIBROMOPROPYL) PHOSPHATE	0.98	0.93	1.0
TRYPAN BLUE	0.8527	0.93	1.0
URACIL	0.8042	0.93	1.0
URACIL MUSTARD	0.8527	0.93	1.0
UREA	0.3876	0.0164	1.0
URETHANE	0.2258	0.0238	0.9996
VALERIC ACID	0.2461	0.75	0.9943
VINYL ACETATE	0.5924	0.7478	0.9994
VINYL ACETYLENE	0.98	1.2315	1.0
VINYL BROMIDE	0.8486	0.6288	1.0
VINYL CHLORIDE	0.9706	1.0808	1.0
XYLENE	0.7884	1.2063	1.0
XYLENE(-m)	0.8207	1.2063	1.0
XYLENE(-o)	0.7866	1.2063	1.0
XYLENE(-p)	0.8236	1.2063	1.0
XYLIDINE dimethylaniline	0.0737	0.1312	0.591
XYLYL CHLORIDE M	0.5925	0.93	1.0
XYLYL CHLORIDE O	0.5925	0.93	1.0
CYMENE,para	0.8706	1.1927	1.0
DIMETHYL TRISULFIDE	0.98	0.354	1.0
ETHYL TOLUENE, 4	0.8571	1.1977	1.0



APPENDIX C

Estimation of Compound Properties:  
Correlations for  $F_m$ ,  $F_r$ , and  $F_e$

April 14, 1994

**MEMORANDUM**

SUBJECT: Estimation of Compound Properties: Correlations for Fm Fr, and Fe.

FROM: C. Allen, RTI

TO: Elaine Manning, CPB

For compounds listed as hazardous air pollutants, individual calculations of Fm, Fr, and Fe are available as a data base. These values in the data base are used for hazardous air pollutants. For other compounds, there are no listed values of Fm, Fr, and Fe. Correlations were developed to assist in the estimation of these properties.

**Estimation of the fraction measured, Fm**

Attachment 1 presents a correlation between 25D Fm and the Henry's law constant (25 °C). The correlation has a substantial amount of scatter, but there is a general trend between the data sets. The following list presents the correlation that was used to estimate the value of EPA Method 25D.

Value of K25	Value of Method 25D
>100	0.93
>30	0.93
>3	0.75
>0.5	0.44
>0.1	0.15
>0.01	0.124
other	0.02

This list was developed by averaging the values of the EPA Method 25D in each applicable range. For example, the average value of Method 25D between 30 and 3 was 0.75.

**Estimation of the fraction removed, Fr**

To estimate the effectiveness of steam stripping, a compound specific value of the Henry's law constant at 100 ( $K_{100}, y/x$ ) is required. Attachment 2 presents a correlation between ( $K_{100}, y/x$ ) and the Henry's law constant (25 °C). The correlation has a substantial amount of scatter, but is generally linear when plotted as logs. The following equation presents the correlation that was used to estimate the value of ( $K_{100}, y/x$ ).

$$K_{100} = 49.4 K^{0.71}(\text{at } 25^\circ)$$

### **Estimation of the fraction emitted, Fe**

The following list presents a correlation between the estimated value of Fe and the Henry's law constant (25 °C). Missing values of Fe are obtained by linear interpolation between the end points of each range. The correlation has a substantial amount of scatter, but there is a general trend between the data sets. The following list presents the correlation that was used to estimate the value of Fe.

Value of K25	Value of Fe
3500	0.98
550	0.85
150	0.7
50	0.55
21	0.445
5	0.3
0.3	0.1
0.0122	0.048
0.0	0.0

The estimate for a compound with a value of K25 of 1 would be calculated as follows:

$$\text{Fe} = 0.1 + (1-0.3)(0.3-0.1)/(5-0.3)$$

$$\text{Fe} = 0.13$$

United States  
Environmental Protection  
Agency

Office of Air Quality  
Planning and Standards  
Research Triangle Park NC 27711

EPA-453/D-93-056

September 1992

---

Air

---



## Guideline Series

# Control of Volatile Organic Compound Emissions from Industrial Wastewater

### DRAFT DOCUMENT

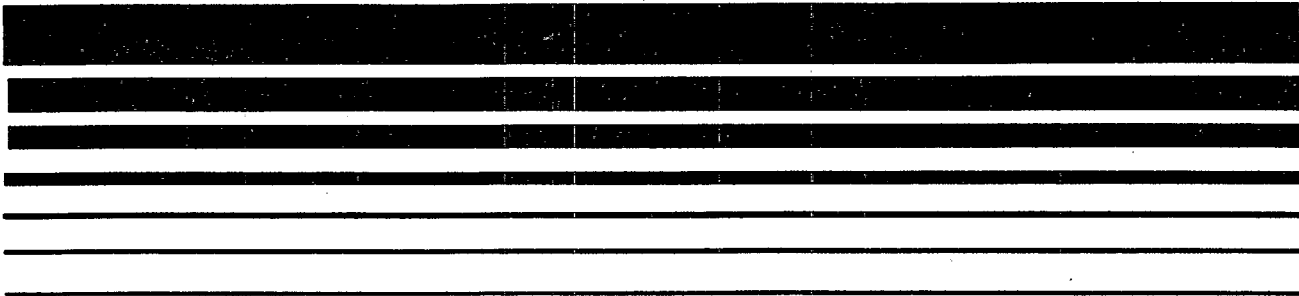

CTG

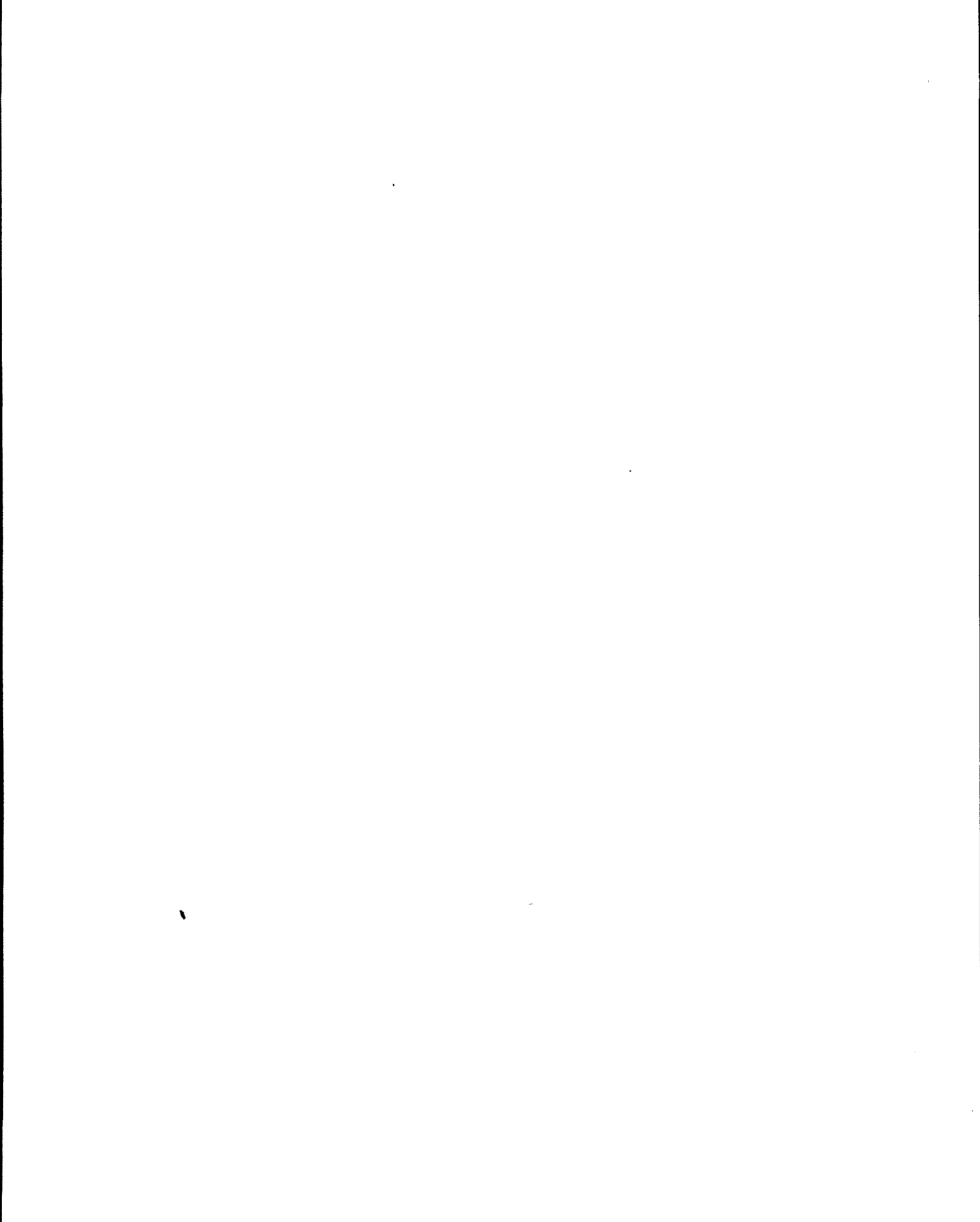

## **DRAFT**

This document has not been formally released by EPA and should not now be construed to represent Agency policy. It is being circulated for comment on its technical accuracy. Mention of trade names or commercial products is not intended to constitute endorsement or recommendation for use.

# **Guideline Series**

## **Control of Volatile Organic Compound Emissions from Industrial Wastewater**

### **DRAFT DOCUMENT**

Emission Standards Division

U.S. ENVIRONMENTAL PROTECTION AGENCY  
Office of Air and Radiation  
Office of Air Quality Planning and Standards  
Research Triangle Park, North Carolina 27711

September 1992

## OAQPS GUIDELINES SERIES

The guideline series of reports is issued by the Emission Standards Division, Office of Air Quality Planning and Standards, U. S. Environmental Protection Agency, to provide information to state and local air pollution control agencies; for example, to provide guidance on the acquisition and processing of air quality data and on the planning and analysis requisite for the maintenance of air quality. Reports published in this series will be available - as supplies permit - from the Library Services Office (MD-35), U. S. Environmental Protection Agency, Research Triangle Park, North Carolina 27711, phone number (919) 541-2777.



## TABLE OF CONTENTS

<u>Section</u>	<u>Page</u>
List of Tables . . . . .	vii
List of Figures . . . . .	ix
1.0 INTRODUCTION . . . . .	1-1
1.1 References . . . . .	1-5
2.0 INDUSTRY DESCRIPTIONS . . . . .	2-1
2.1 Organic Chemicals, Plastics, and Synthetic Fibers Manufacturing Industry . . . . .	2-4
2.2 Pesticides Manufacturing Industry . . . . .	2-8
2.3 Petroleum Refining Industry . . . . .	2-10
2.4 Pharmaceuticals Manufacturing Industry . . . . .	2-13
2.5 Hazardous Waste Treatment, Storage, and Disposal Facilities Industry . . . . .	2-15
2.6 Pulp, Paper and Paperboard and Builders' Paper and Board Mills Industry . . . . .	2-18
2.7 References . . . . .	2-23
3.0 VOLATILE ORGANIC COMPOUND EMISSIONS DURING WASTEWATER COLLECTION AND TREATMENT . . . . .	3-1
3.1 Sources of Organic Compound-Containing Wastewater . . . . .	3-1
3.1.1 Direct Contact Wastewater . . . . .	3-2
3.1.2 Indirect Contact Wastewater . . . . .	3-2
3.2 Sources of Air Emissions . . . . .	3-3
3.2.1 Drains . . . . .	3-3
3.2.2 Manholes . . . . .	3-5
3.2.3 Junction Boxes . . . . .	3-6
3.2.4 Lift Stations . . . . .	3-7
3.2.5 Trenches . . . . .	3-8
3.2.6 Sumps . . . . .	3-9
3.2.7 Weirs . . . . .	3-9
3.2.8 Oil/Water Separators . . . . .	3-10
3.2.9 Equalization Basins . . . . .	3-11
3.2.10 Clarifiers . . . . .	3-12
3.2.11 Aeration Basins . . . . .	3-12
3.2.12 Treatment Tanks . . . . .	3-13
3.2.13 Surface Impoundments . . . . .	3-14
3.3 Volatile Organic Compound Emission Estimation . . . . .	3-14
3.4 References . . . . .	3-17

TABLE OF CONTENTS  
(continued)

<u>Section</u>	<u>Page</u>
4.0 VOLATILE ORGANIC COMPOUND EMISSION CONTROL TECHNIQUES . . . . .	4-1
4.1 Waste Minimization . . . . .	4-2
4.1.1 Gather Baseline Data . . . . .	4-2
4.1.2 Identify and Rank Sources for Reduction . . . . .	4-2
4.1.3 Implementation of Reduction/ Recycling . . . . .	4-3
4.2 Organic Compound Treatment Technologies . . . . .	4-3
4.2.1 Steam Stripping . . . . .	4-3
4.2.2 Air Stripping . . . . .	4-14
4.2.3 Biological Organic Compound Destruction Technology . . . . .	4-16
4.2.4 Other Organic Compound Removal Technologies . . . . .	4-19
4.3 Volatile Organic Compound Emission Suppression from Collection and Treatment System Components . . . . .	4-21
4.3.1 Collection System Controls . . . . .	4-21
4.3.2 Roofs . . . . .	4-22
4.3.3 Floating Membrane Covers . . . . .	4-24
4.3.4 Air-Supported Structures . . . . .	4-25
4.4 Add-On Controls . . . . .	4-26
4.4.1 Carbon Adsorbers . . . . .	4-26
4.4.2 Thermal Vapor Incinerators . . . . .	4-28
4.4.3 Combination Adsorption--Incineration . . . . .	4-29
4.4.4 Catalytic Vapor Incinerators . . . . .	4-31
4.4.5 Flares . . . . .	4-32
4.4.6 Boilers and Process Heaters . . . . .	4-32
4.4.7 Condensers . . . . .	4-33
4.5 References . . . . .	4-34
5.0 CONTROL COST, ENVIRONMENTAL, AND ENERGY IMPACT ANALYSES OF TREATMENT BY STEAM STRIPPING . . . . .	5-1
5.1 Steam Stripper System Costs . . . . .	5-1
5.1.1 Basis for Capital Costs . . . . .	5-1
5.1.2 Basis for Annualized Costs . . . . .	5-11
5.2 Environmental and Energy Impacts of Steam Stripping . . . . .	5-17
5.2.1 Primary Air Pollution Impacts-- Volatile Organic Compound Emission Impacts . . . . .	5-17
5.2.2 Secondary Air Pollution Impacts . . . . .	5-19

TABLE OF CONTENTS  
(continued)

<u>Section</u>	<u>Page</u>
5.2.3 Other Impacts . . . . .	5-22
5.3 References . . . . .	5-27
<b>6.0 SELECTION OF REASONABLY AVAILABLE CONTROL TECHNOLOGY . . . . .</b>	<b>6-1</b>
6.1 Background . . . . .	6-1
6.2 Reasonably Available Control Technology Options and Impacts . . . . .	6-3
6.2.1 Reasonably Available Control Technology Options Formats . . . . .	6-4
6.2.2 Reasonably Available Control Technology Options Impacts . . . . .	6-6
6.3 Selection of Reasonably Available Control Technology . . . . .	6-8
6.4 References . . . . .	6-9
<b>7.0 REASONABLY AVAILABLE CONTROL TECHNOLOGY IMPLEMENTATION . . . . .</b>	<b>7-1</b>
7.1 Introduction . . . . .	7-1
7.2 Definitions . . . . .	7-1
7.3 Applicability . . . . .	7-4
7.3.1 Applicability Criteria . . . . .	7-5
7.4 Format of the Standards . . . . .	7-6
7.4.1 Emission Suppression from Wastewater Collection . . . . .	7-6
7.4.2 Wastewater Treatment to Reduce Volatile Organic Content . . . . .	7-7
7.4.3 Treatment of Residuals . . . . .	7-11
7.5 Performance Testing . . . . .	7-11
7.5.1 Wastewater Collection . . . . .	7-12
7.5.2 Wastewater Treatment . . . . .	7-12
7.5.3 Treatment of Residual Vapors from Wastewater Collection and Treatment Systems . . . . .	7-12
7.6 Monitoring Requirements . . . . .	7-13
7.6.1 Wastewater Collection . . . . .	7-13
7.6.2 Wastewater Treatment . . . . .	7-13
7.6.3 Treatment of Residual Vapors from Wastewater Collection and Treatment Systems . . . . .	7-14

TABLE OF CONTENTS  
(continued)

<u>Section</u>	<u>Page</u>
7.7 Reporting/Recordkeeping Requirements . . . . .	7-14
7.8 Relationships to Title III (Section 112) of the Clean Air Act Amendments . . . . .	7-15
APPENDIX A: Model Rule . . . . .	A-1
APPENDIX B: National Impacts Analysis . . . . .	B-1

LIST OF TABLES

<u>Table</u>		<u>Page</u>
2-1	WASTEWATER GENERATION BY INDUSTRY . . . . .	2-3
2-2	DISTRIBUTION OF AFFECTED INDUSTRIAL CATEGORIES IN AREAS OF OZONE NONATTAINMENT . . . . .	2-5
2-3	GENERIC CHEMICAL PROCESSES . . . . .	2-7
2-4	VOLATILE ORGANIC COMPOUND (VOC) LOADING IN SOCMI WASTEWATER STREAMS . . . . .	2-11
2-5	HAZARDOUS WASTE TREATMENT, STORAGE, AND DISPOSAL FACILITIES INDUSTRY CHARACTERIZATION . .	2-17
2-6	MILL POPULATION . . . . .	2-20
3-1	EMISSION SOURCES IN WASTEWATER COLLECTION AND TREATMENT SYSTEMS . . . . .	3-4
4-1	DESIGN AND OPERATING BASIS FOR THE STEAM STRIPPING SYSTEM . . . . .	4-6
4-2	STEAM STRIPPER ORGANIC COMPOUND REMOVAL PERFORMANCE . . . . .	4-11
5-1	EQUIPMENT COST EQUATIONS FOR A STEAM STRIPPING UNIT . . . . .	5-5
5-2	ESTIMATION OF BASIC EQUIPMENT COST FOR A STEAM STRIPPING UNIT . . . . .	5-7
5-3	ESTIMATION OF TOTAL CAPITAL INVESTMENT FOR A STEAM STRIPPING UNIT . . . . .	5-9
5-4	ESTIMATION OF TOTAL ANNUAL COST FOR A STEAM STRIPPING UNIT . . . . .	5-12
5-5	VOLATILE ORGANIC COMPOUND EMISSION REDUCTION FOR STEAM STRIPPING . . . . .	5-20
5-6	COMBUSTION POLLUTANT EMISSION FACTORS FOR STEAM GENERATION . . . . .	5-21
5-7	SECONDARY AIR POLLUTION IMPACTS OF EXAMPLE WASTEWATER STREAM . . . . .	5-23
5-8	ANNUAL FUEL USE FOR STEAM GENERATION FOR STEAM STRIPPER CONTROL OF EXAMPLE WASTEWATER STREAM . . . . .	5-26

LIST OF TABLES  
(Continued)

<u>Table</u>		<u>Page</u>
6-1	TOTAL INDUSTRY RACT NATIONAL IMPACTS . . . . .	6-7
7-1	VOLATILE ORGANICS STRIPPABILITY GROUPS AND TARGET REMOVAL EFFICIENCIES . . . . .	7-9

LIST OF FIGURES

<u>Figure</u>		<u>Page</u>
4-1	Continuous steam stripper system . . . . .	4-5
4-2	Predicted steam stripper organic compound removal efficiencies based on $-\log$ Henry's Law constant for the compound at 25 °C . . . . .	4-13
4-3	Continuous air stripper system . . . . .	4-15
4-4	Combination carbon adsorption - thermal incineration system . . . . .	4-30
5-1	Summary of total capital investment versus wastewater feed rate for steam stripping unit . .	5-10
5-2	Total annual cost versus wastewater feed rate for steam stripping unit . . . . .	5-16
5-3	Unit operating costs versus wastewater feed rate for steam stripping unit . . . . .	5-18

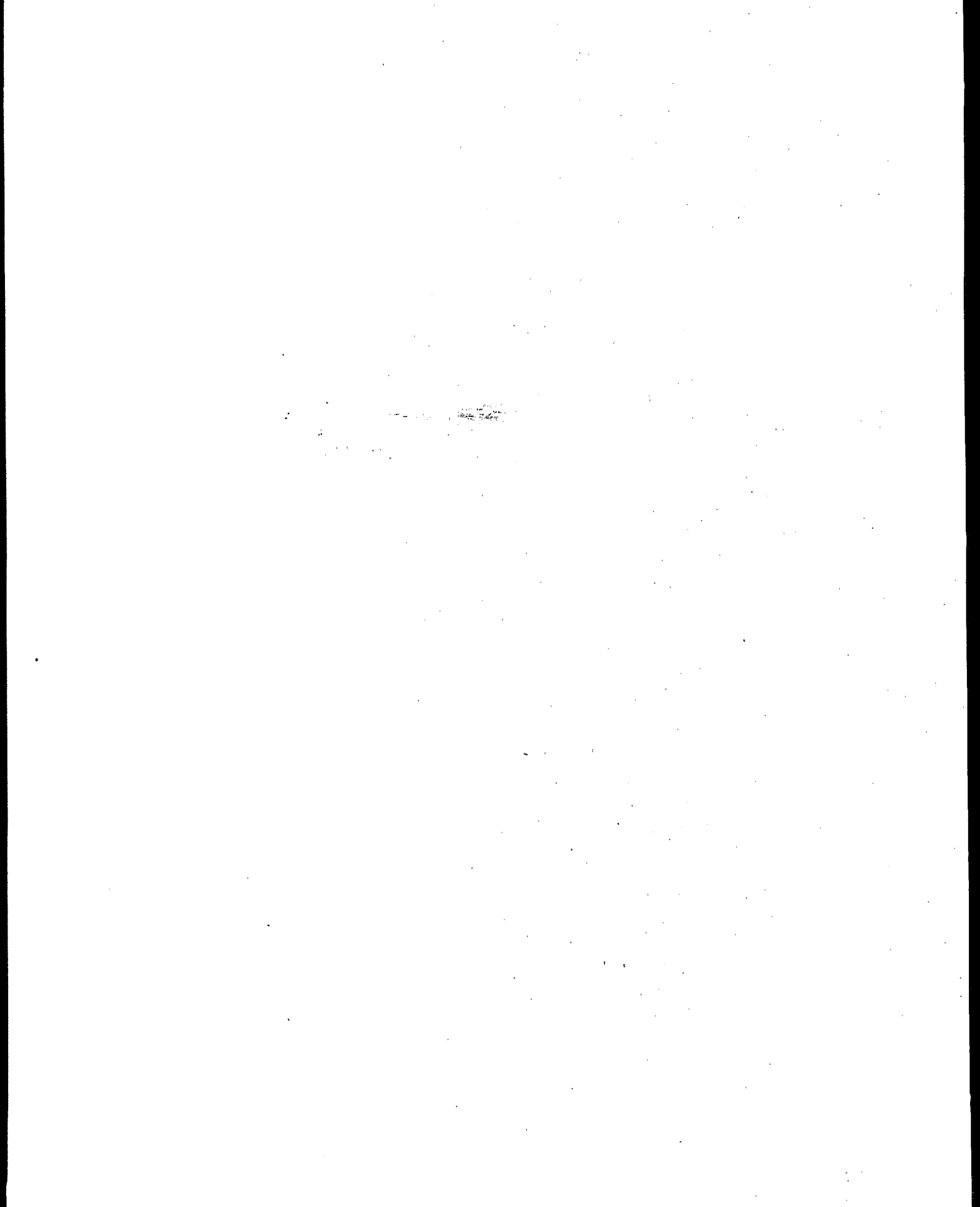



## 1.0 INTRODUCTION

The Clean Air Act (CAA) Amendments of 1990 require that State implementation plans (SIP's) for certain ozone nonattainment areas be revised to require the implementation of reasonably available control technology (RACT) for control of volatile organic compound (VOC) emissions from sources for which control techniques guidelines (CTG's) have already been published or for which a CTG document will be published between the date of enactment of the Amendments and the date on which an area achieves attainment status.

Section 182(b)(2). Section 172(c)(1) of the CAA requires nonattainment area SIP's to provide, at a minimum, for "...such reductions in emissions from existing sources in the area as may be obtained through the adoption, at a minimum, of reasonably available control technology..." As a starting point for ensuring that these SIP's provide for the required emission reduction, the Agency, in a Federal Register notice (44 FR 53761, September 17, 1979)<sup>1</sup> defines RACT as: "The lowest emission limitation that a particular source is capable of meeting by the application of control technology that is reasonably available considering technological and economic feasibility." Subsequent Federal Register notices elaborate on how States and the Agency should apply the RACT requirements (53 FR 45103, November 8, 1988)<sup>2</sup>.

The CTG's are intended to provide State and local air pollution authorities with an information base for proceeding with their own analyses of RACT to meet statutory requirements. The CTG's review current knowledge and data concerning the technology and costs of various emissions

control techniques. Each CTG contains a "presumptive norm" for RACT for a specific source category, based on the Agency's evaluation of the capabilities and problems general to that category. Where applicable, the Agency recommends that States adopt requirements consistent with the presumptive norm. However, the presumptive norm is only a recommendation. States may choose to develop their own RACT requirements on a case-by-case basis, considering the economic and technical circumstances of an individual source. It should be noted that no laws or regulations preclude States from requiring more control than recommended as the presumptive norm for RACT. A particular State, for example, may need a more stringent level of control in order to meet the ozone standard or to reduce emissions of a specific toxic air pollutant.

This CTG is 1 of at least 11 that the Agency is required to publish within 3 years of enactment of the CAA Amendments. Section 183(a). It addresses RACT for control of VOC emissions from the collection and treatment of industrial wastewater from: the organic chemicals, plastics, and synthetic fibers (OCPSF) industry; the pesticides manufacturing industry; the pharmaceuticals manufacturing industry; and the hazardous waste treatment, storage, and disposal facilities (TSDF) industry. The CTG also contains information on two other industries: the pulp and paper, and petroleum refining industry, but does not recommend RACT for these industries due to other regulatory actions (i.e., MACT standards) that will address them.

Based on information collected by the Agency, facilities within each of these industries have the potential to generate wastewaters containing high concentrations of volatile organic compounds. These wastewaters typically pass through a series of collection and primary treatment units before treatment is applied to remove a portion of the volatile organics. Many of these collection and treatment units are open to the atmosphere and allow wastewaters containing volatile organics to contact ambient air. Atmospheric exposure of these

organic-containing wastewaters results in significant volatilization of VOC's from the wastewater.

These emissions can be reduced by applying control at the point of generation of the wastewater, before the stream contacts ambient air. One effective strategy is to apply waste minimization techniques to reduce the volatile organic loading of the wastewaters, or to produce a more manageable waste stream through waste segregation or recycling. However, even with waste minimization, some waste streams will be generated. Emissions from these streams can be reduced by controlling the wastewater streams from the point of generation to a controlled treatment system.

This control approach is consistent with existing and upcoming regulations affecting the wastewaters generated within these industries, including the Office of Water's Effluent Guidelines for the OCPSF, Pesticides, and Pharmaceuticals industries; The Resource Conservation and Recovery Act (RCRA) Air Emission Standards affecting TSDF facilities; and other air emission control requirements affecting these industries. Existing and future effluent guidelines for these industries require treatment of the wastewater to ensure that concentrations of specific priority pollutants in the combined wastewater stream exiting the facility do not exceed established limits. While these concentration limits for volatile organic compounds are based on the performance capability of steam stripping, the limits do not require control of air emissions during the collection and treatment of these wastewaters. Although the RCRA air emission standards for TSDF specifically address air emissions from wastewater, this rule is limited in scope to include hazardous waste managed in units subject to permitting requirements of Subtitle C of RCRA. RCRA Subtitle D surface impoundments would not be covered by this rule.

In addition to these rules, there are existing and upcoming air regulations which affect the wastewaters generated within these industries. These regulations include

the "Benzene Waste Operations National Emission Standards for Hazardous Air Pollutants (NESHAP)" (55 FR 8292)<sup>3</sup>, promulgated in March 1990, and the Hazardous Organic NESHAP (HON). The Benzene NESHAP requires control of benzene-containing wastewater streams generated by chemical manufacturing plants; coke by-product recovery plants; petroleum refineries; and facilities that treat, store, or dispose of wastes generated within these industries. The HON will require the application of maximum achievable control technology (MACT) to control hazardous air pollutant (HAP) emissions from wastewaters generated in the synthetic organic chemical manufacturing industry (SOCMI), which is a subset of the OCPSF industry. Other MACT standards will be developed to address wastewaters generated by the remainder of the OCPSF industry, pesticides, pharmaceuticals, and TSDF industries. However, these standards will only address HAP emissions and not total VOC emissions.

The industries that are included in this CTG have wastewater streams which contain large amounts of HAP. Because most organic HAP are also VOC and other VOC often would also be found in the HAP-containing streams, the MACT standards will achieve some control of VOC emissions. For most industries, however, many VOC-containing wastewaters do not contain HAP and therefore, controlling only HAP-containing streams, as would be required under a MACT standard, would not substantially reduce VOC emissions. This would, in general, indicate that there is a need for both MACT standards to regulate HAP emissions and a CTG to control non-HAP VOC emissions in nonattainment areas. For the pulp and paper and petroleum refining industries, however, the Agency presently believes that wastewater streams that contain non-HAP VOC also contain a substantial amount of HAP. Therefore, the MACT standards for these industries will substantially reduce VOC emissions. For this reason, the recommended RACT outlined in the CTG is not suggested for the pulp and paper and petroleum refining industries. It should also be noted that the control

alternatives and exclusions presented in this document will provide for consistency in application of control strategies to meet the various regulations.

Because the HON has not yet been proposed and is still undergoing revision, there may be some inconsistencies between this document and the HON; however, any revisions to the HON will be incorporated into the final CTG. Several changes have already been made to the HON. One of the changes is in relation to the strippability groups A - E. The HON has grouped compounds into 5 groups depending on the compounds' strippability. Presently the Agency has decided to eliminate requirements for control of group D and E compounds from the draft proposed HON regulation which equates to groups IV and V in this draft CTG document. The Agency has also revised the Henry's Law constants used in the HON. The revision of the Henry's Law constants will effect the fraction emitted (Fe), fraction removed (Fr), and fraction measured (Fm) used in the equations. Also the calculation of uncontrolled emissions is being altered. Other changes to the HON under consideration include changes to the wastewater collection and treatment scenarios and adjustments to the wastewater emission estimate models. Although certain changes have been implemented for the HON, the impacts shown for the draft CTG do not reflect these changes for several reasons. Elimination of strippability groups IV and V will not appreciably change the emission reductions or cost effectiveness numbers, and would not be anticipated to affect the selection of draft RACT. As previously mentioned, the HON is still in a state of flux with various changes being considered. Lastly, timing is a consideration because publishing this draft CTG in the same time period as the proposal of the HON would provide source owners and operators the opportunity to review and comment on the interrelationship of the two. This would also put the HON and CTG on the same schedule to be finalized which would be helpful to sources when developing their control strategies.

The organization of this document is as follows. A description of the industries covered by this document is presented in Chapter 2.0. The sources of organic-containing wastewater, sources of VOC air emissions, and model wastewater streams are identified in Chapter 3.0. Available VOC emission control strategies and control costs associated with the recommended treatment technologies are presented in Chapters 4.0 and 5.0, respectively. A description of RACT and guidance to the States on implementation of RACT are presented in Chapters 6.0 and 7.0, respectively.

A more detailed discussion of information on sources of VOC air emissions, available VOC emission control technologies, and calculation of emissions from example sources can be found in a document generated by the Control Technology Center (CTC) entitled "Industrial Wastewater Volatile Organic Compound Emissions--Background Information for BACT/LAER Determinations" (EPA 450/3-90-004, January 1990),<sup>4</sup> hereafter referred to as the Wastewater CTC Document.

## 1.1 REFERENCES

1. Federal Register. State Implementation Plans; General Preamble for Proposed Rulemaking on Approval of Plan Revisions for Nonattainment Areas-Supplement (On Control Techniques Guidelines) 44 FR 53761 to 53763. September 17, 1979.
2. Federal Register. Approval and Promulgation of Implementation Plan; Illinois. 53 FR 45103 to 45111. November 8, 1988.
3. Federal Register. National Emission Standards for Hazardous Air Pollutants; Benzene Emissions From Chemical Manufacturing Process Vents, Industrial Solvent Use, Benzene Waste Operations, Benzene Transfer Operations, and Gasoline Marketing System. 55 FR 8292 to 8361. March 7, 1990.
4. Office of Air Quality Planning and Standards, U. S. Environmental Protection Agency. Research Triangle Park, North Carolina. Industrial Wastewater Volatile Organic Compound Emissions--Background Information for BACT/LAER Determinations. EPA 450/3-90-004. January 1990.

The first part of the document discusses the importance of maintaining accurate records of all transactions. It emphasizes that every entry should be clearly documented, including the date, amount, and purpose of the transaction. This ensures transparency and allows for easy reconciliation of accounts.

In addition, the document highlights the need for regular audits. By conducting periodic reviews of the financial records, any discrepancies or errors can be identified and corrected promptly. This proactive approach helps in maintaining the integrity of the financial data and prevents potential issues from escalating.

Furthermore, the document stresses the importance of keeping records secure. All financial information should be stored in a safe and accessible location, protected from unauthorized access. This is crucial for safeguarding the organization's assets and ensuring compliance with relevant regulations.

Finally, the document concludes by stating that thorough record-keeping is essential for the long-term success of any business. It provides a clear foundation for financial analysis, budgeting, and strategic decision-making. By adhering to these principles, organizations can ensure their financial health and stability.



## 2.0 INDUSTRY DESCRIPTIONS

This control techniques guideline (CTG) document applies to the industrial wastewater generated in areas that are considered nonattainment areas for ozone within the following industries:

- The organic chemicals, plastics, and synthetic fibers (OCPSF) industry;
- The pesticides manufacturing industry;
- The pharmaceuticals manufacturing industry;
- The hazardous waste treatment, storage, and disposal facilities (TSDF) industry;
- The petroleum refining industry; and
- The pulp, paper, and paperboard and builders paper and board mills industry (pulp and paper industry).

This document describes all six industries. However, only the first four industries listed above are utilized for determining RACT. The rationale for excluding the pulp and paper and petroleum refining industries for determining RACT is presented in Chapter 6.0. This chapter contains information on wastewater streams generated by these six industries. The industry descriptions and wastewater characteristics presented in this chapter reflect data collected by the Agency on volatile organic compound (VOC) emissions from industrial wastewater and work performed by the Agency either to develop effluent guidelines or to evaluate the need to develop effluent guidelines.<sup>1-10</sup>

Each of the six industries listed above generates large quantities of wastewater containing organics. Although most of the wastewater contains less than 1 percent (10,000 parts

per million by weight [ppmw]) of total organics, this is a potentially significant source of emissions because of the large quantities of wastewater generated. These six industries are included together in this document because the organic content of the wastewater is similar. Additionally, the wastewater collection and treatment systems are similar across the six affected industries.

Table 2-1 presents estimates of the number of facilities and the quantities of wastewater generated by each industry. Based on information gathered by the Agency in developing effluent guideline limitations, there were approximately 466 pharmaceutical, 119 pesticide, 1,000 OCPSF, and 1,909 TSDF facilities in 1982. The Oil and Gas Journal Annual Refining Survey reported that there were 190 operating refineries in the United States in 1990.<sup>11</sup> Facilities in these five industries produced approximately 4.2 billion liters (1.1 billion gallons) of wastewater per day. Approximately 695 pulp and paper facilities were identified in 1982. These facilities produce approximately 7.4 billion liters (2 billion gallons) of wastewater per day.

In some cases, two or more industrial categories may be located within the same facility. For example, an OCPSF facility which produces petrochemicals may be located within a petroleum refinery.

Based on available flow and concentration data, the quantity of VOC in wastewater generated by each of these six industries is considered significant. In addition, based on the available information, similar controls are applicable for sources within each industry. In all cases, controls should be applied as close to the point of generation as possible in the process, or before the wastewater stream contacts ambient air. By applying the controls as close to the point of generation as possible, the stream can be controlled before it contacts the atmosphere, and emits VOC's to the atmosphere or before the stream is diluted with other wastewater streams.

TABLE 2-1. WASTEWATER GENERATION BY INDUSTRY

Industry	Total number of facilities (1982)	Daily wastewater generation (Mgal/d) <sup>a</sup>
OCPSF	1,000	527
Pesticides manufacturing	119	<100
Petroleum refining	190 <sup>b</sup>	422
Pharmaceutical manufacturing	466	82
Hazardous waste TSDF	1,909	16 <sup>c</sup>
Pulp and paper	603 <sup>d</sup>	1,946
TOTAL	4,287	3,093

<sup>a</sup>Mgal/d = Million gallons per day.

<sup>b</sup>Based on a 1990 inventory of operating refineries (Reference 11).

<sup>c</sup>Represents wastewater generated by the TSDF category as landfill leachate.

<sup>d</sup>A 1989 estimate (Ref. 6).

Steam stripping is a control technology that is applied throughout these industries. For example, the organic limits for the OCPSF industry effluent limitations are based on effluent levels that can be achieved by steam stripping.<sup>12</sup> Additionally, new guidelines for pesticides and TSDF facilities, revisions to existing guidelines for OCPSF and pharmaceuticals industries, and review of existing guidelines for the petroleum refining industry are all expected to be similarly based. Plans for reviewing and revising existing effluent guidelines and promulgating new effluent guidelines were announced January 2, 1990 in the Federal Register (55 FR 80, January 2, 1990).<sup>13</sup>

The following sections discuss each of the six industries included in this document in terms of the approximate number of facilities and the number of processes or products, and quantities and characteristics of wastewater generated by facilities in these industries. The distribution of each of the six affected industrial categories in areas of ozone nonattainment is summarized in Table 2-2.

#### 2.1 ORGANIC CHEMICALS, PLASTICS, AND SYNTHETIC FIBERS MANUFACTURING INDUSTRY

Approximately 1,000 facilities are included in the OCPSF industry, defined as all facilities falling under the following standard industrial classification (SIC) codes:

- 2821 Plastics Materials, Synthetic Resins, and Nonvulcanizable Elastomers;
- 2823 Cellulosic Manmade Fibers;
- 2824 Synthetic Organic Fibers, except Cellulosic;
- 2865 Cyclic Crudes and Cyclic Intermediates, Dyes, and Organic Pigments; and
- 2869 Industrial Organic Chemicals, Not Elsewhere Classified.

Approximately 43 percent of the OCPSF facilities are located in areas of nonattainment.

The OCPSF industry includes a diversity of chemical processes producing a large number of chemical products. Some

TABLE 2-2. DISTRIBUTION OF AFFECTED INDUSTRIAL CATEGORIES  
IN AREAS OF OZONE NONATTAINMENT

Affected Industry	Percent (%) nonattainment <sup>14</sup>
OCPSF	43
Pesticides manufacturing	36
Petroleum refining	52
Pharmaceutical manufacturing	57
Hazardous waste TSDF	43
Pulp and paper	43

facilities within these industrial categories produce large volumes of a single product continuously while other facilities may produce various specialty products in short campaigns. However, despite the diversity of this industry, the Agency has determined that 98 percent of all products manufactured are produced by one of 41 major generic processes. These processes are listed in Table 2-3.

The OCPSF industry generates about 530 Mgal/d of wastewater. Most of the wastewater collection systems at facilities in the OCPSF industry are underground sewers. Very few wastewater streams are transported in overhead pipes. In addition, in some facilities, vigorous aeration of the wastewater (which can cause high VOC emissions) prior to biological treatment is used to improve the biological activity. Based on Office of Air Quality Planning and Standards (OAQPS) visits to several facilities in the OCPSF industry, significant potential exists in this industry for emissions of VOC's from wastewater.

Model streams representing the OCPSF industry were developed from responses to a CAA Section 114 survey of the synthetic organic chemical manufacturing industry (SOCMI). These model streams are used to represent the OCPSF industry because SOCMI is a subset of the OCPSF industry, the processes generating wastewater in SOCMI are the same or similar to the processes in the rest of the OCPSF industry, and the same volatile chemicals are used.

Under authority of Section 114 of the Clean Air Act (CAA) Amendments of 1990, facilities within nine corporations were asked to complete questionnaires that requested information on wastewater streams from SOCMI product processes. Facilities provided information on the flow rate and concentration of individual hazardous air pollutants (HAP's) and total VOC's in each wastewater stream. These responses provided sufficient information to allow the characterization of flow rate, VO concentration, and emission potential and strippability of

TABLE 2-3. GENERIC CHEMICAL PROCESSES<sup>a</sup>

---

1. Acid Cleavage	22. Extractive Distillation
2. Alkoxylation	23. Fiber Production
3. Alkylation	24. Halogenation
4. Amination	25. Hydration
5. Ammonolysis	26. Hydroacetylation
6. Ammoxidation	27. Hydrodealkylation
7. Carbonylation	28. Hydrogenation
8. Chlorohydrination	29. Hydrohalogenation
9. Condensation	30. Hydrolysis
10. Cracking	31. Isomerization
11. Crystallization/Distillation	32. Neutralization
12. Cyanation/Hydrocyanation	33. Nitration
13. Dehydration	34. Oxidation
14. Dehydrogenation	35. Oximation
15. Dehydrohalogenation	36. Oxyhalogenation
16. Distillation	37. Peroxidation
17. Electrohydrodimerization	38. Phosgenation
18. Epoxidation	39. Polymerization
19. Esterification	40. Pyrolysis
20. Etherification	41. Sulfonation
21. Extraction	

---

<sup>a</sup>Reference 1.

individual wastewater streams from the processes. Additional details regarding development of the OCPSF model streams may be found in Appendix B.

Responses to a March 1990 CAA Section 114 survey of SOCFI facilities indicate that concentrations of organic compounds are highly variable in process wastewater generated by SOCFI facilities. Although concentrations for different organic compounds are highly variable, the data indicate that a small number of wastewater streams contribute the majority of the organic compounds in the wastewater. The organic compound mass loading was computed for each process wastewater stream where data were available from facility responses to the CAA Section 114 information requests, and a total organic quantity representing all the reported streams was determined by summing the organic quantities computed for each individual wastewater stream. Based on these data, approximately 20 percent of the individual wastewater streams were found to account for more than 95 percent of the organics by mass.<sup>15</sup> Although wastewaters generated in the OCPSF industry may contain moderate levels of oil and grease or suspended solids, steam stripping has been demonstrated as a technically feasible control for treating the wastewater streams generated by OCPSF facilities.

## 2.2 PESTICIDES MANUFACTURING INDUSTRY

The pesticides manufacturing industry provides a wide range of chemicals used to control crop-destroying insects and undesirable vegetation. This document covers the segment of the pesticide industry that manufactures the active ingredients in pesticide chemicals. One hundred nineteen such plants were identified in development of the 1985 effluent standards (50 FR 40674, October 4, 1985).<sup>16</sup> These plants produce pesticide products covered under SIC code 2879: Pesticides and Agricultural Chemicals, Not Elsewhere Classified. Approximately 36 percent of the pesticides manufacturing facilities are located in areas of ozone nonattainment.



The volume of wastewater discharged by facilities in this industry ranges from less than 10,000 gallons per day to 1 Mgal/d, with over half the facilities in the industry generating less than 10,000 gallons per day. Discharge methods vary from plant to plant and one method or a combination of methods may be used.

A variety of organic compounds have been detected in pesticides industry wastewater streams. These include: phenols, aromatics, halomethanes, chlorinated ethanes, nitrosamines, dienes, cyanides, and pesticide compounds. Sampling data generated during the development of effluent guidelines on organic concentrations for the industry include organic priority pollutant and active ingredient concentration data. Priority pollutants are defined by a list of 126 compounds specified by the Office of Water as an outgrowth of a 1976 consent decree. High concentrations of halomethanes and chlorinated ethanes were detected in the pesticide plant wastewaters. The organic compounds detected in the wastewaters are used as solvents and raw materials or occur as impurities or byproducts. The sources and characteristics of wastewaters generated by pesticide manufacturing facilities are expected to be similar to those in the OCPSF industry.

Steam stripping of wastewaters generated by facilities in the pesticides industry has been demonstrated as a technically feasible control. This fact is supported by detailed information provided on 10 steam strippers in use at pesticides industry plants in the Development Document for Effluent Limitations Guidelines and Standards for the Pesticide Point Source Category.<sup>3</sup>

Model streams representing the pesticides manufacturing industry were developed from a 1989 Section 308 survey conducted under authority of the Clean Water Act by the Office of Water Regulations and Standards (OWRS). In the survey, OWRS collected information on wastewater flow rates and VOC concentrations.

A total of 13 responses provided sufficient information to allow the characterization of wastewater flow rate, VOC concentration, and strippability. However, the available data did not present flows and concentrations for individual wastewater streams within each process unit. Instead, data are presented for the combined process unit effluent. Therefore, combined process unit effluent streams were disaggregated into individual streams. The disaggregation of combined effluent streams is based on the VOC loading distribution determined from the Section 114 survey of SOCMI.<sup>15</sup> Table 2-4 presents this loading distribution. Additional details regarding development of the pesticides manufacturing industry model streams may be found in Appendix B.

### 2.3 PETROLEUM REFINING INDUSTRY

In 1990, there were approximately 190 petroleum refineries operating in the United States.<sup>11</sup> These facilities are defined by SIC code 2911 as primarily engaged in the production of hydrocarbon materials by the distillation of crude petroleum and its fractional products. These refineries are distributed among 35 States, with approximately 40 percent of the refineries and over half of the total U. S. crude refining capacity located in Texas, California, and Louisiana. Approximately 52 percent of the petroleum refining facilities are located in areas of ozone nonattainment.

The refining process can be divided into four distinct segments: (1) crude separation; (2) light hydrocarbon processing; (3) middle and heavy distillate processing; and (4) residual hydrocarbon processing. Each of the four segments comprises a number of process modules. The crude separation segment includes crude oil handling and distillation processes that split the crude into three broad factions: light hydrocarbons, middle and heavy distillates, and residual oils. Light hydrocarbons are defined as naphtha boiling range and lighter fractions. Middle and heavy distillates are the fractions boiling between the naphtha

TABLE 2-4. VOLATILE ORGANIC COMPOUND (VOC) LOADING  
IN SOCM I WASTEWATER STREAMS

<u>Percent of wastewater flow</u>	<u>Percent VOC loading</u>
50	2.6
40	35.0
10	62.4

range and the residuals. Residual oils are defined as crude distillation bottoms or residue.

Over 150 separate processes have been identified in the petroleum refining industry. Each refining process consists of a series of unit operations that cause chemical and physical changes in the feedstock or products. Each unit operation may have different water usages. The wastewater is generated by a variety of sources including cooling water, steam stripping condensates, tank draw-offs, and contact process water.

The various distillation and fractionation processes produce the largest volumes of wastewater, with most of the water being discharged from three sources. The first source is the water drawn off from overhead accumulators before recirculation or transfer of hydrocarbons to other fractionators. The second wastewater source is discharge from oil sampling lines, and the third source is from oil emulsions that form in the barometric condensers used to maintain reduced pressures in the vacuum distillation units.

Nearly all refineries include some type of onsite wastewater treatment system. Previous work performed by the Agency indicates that these wastewater collection and treatment systems are significant sources of VOC emissions.<sup>9</sup>

Model streams representing the petroleum refining industry were developed from wastewater generation factors presented in Table B-10 in Appendix B and benzene concentration data reported in the support document, "Final National Emissions Standards for Hazardous Air Pollutants (NESHAP) Standards for Waste Operations."<sup>10</sup> This information was sufficient to allow the characterization of wastewater flow rate, VOC concentration, and strippability. However, the available data did not present flow and concentrations for individual wastewater streams within each process unit. Therefore, combined process unit effluent streams were disaggregated into individual streams, as discussed in Section 2.2. Additional details regarding development of the

petroleum refining industry model streams may be found in Appendix B.

#### 2.4 PHARMACEUTICALS MANUFACTURING INDUSTRY

The pharmaceutical manufacturing industry includes facilities which manufacture, extract, process, purify, and package chemical materials to be used as human and animal medications. Four hundred and sixty-six facilities were identified by the Agency as pharmaceutical manufacturers. Approximately 57 percent of these facilities are located in areas of ozone nonattainment. This industry includes facilities in the following SIC codes:

- 2833 Medicinal Chemicals and Botanical Products;
- 2834 Pharmaceutical Preparations; and
- 2836 Biological Products Except Diagnostic Substances.

Other facilities covered by this document are:

- The manufacture of products considered pharmaceutically active by the Food and Drug Administration;
- The manufacture of nonpharmaceutical products made at pharmaceutical manufacturing facilities that generate wastewater similar to that from pharmaceutical production;
- The manufacture of products "which have non-pharmaceutical uses" but that are "primarily intended for use as a pharmaceutical"; and
- Pharmaceutical research.

Pharmaceutical production operations may be batch, semi-continuous, or continuous. However, batch methods are the most common. Manufacturing in the industry can be characterized by four processes. These are fermentation, extraction, chemical synthesis, and formulation and packaging.

Fermentation is usually a large-scale batch process and involves fermentation, or controlled growth of specific microorganisms, in a reactor vessel to produce a desired product. The desired product is then recovered from the

fermentation broth using solvent extraction, adsorption, precipitation and filtration, or ion exchange. Wastewater streams generated from fermentation processes include discharges from reactor cleanings and sterilizations, off-gas scrubber effluents, and occasional off-specification batches. Solvents used in extracting the product from the broth in the recovery process may be discharged into the sewers in the wastewater streams as well.

Extraction refers to the extraction and recovery of a small volume of desired product from naturally occurring sources such as plant roots and leaves, animal glands, and parasitic fungi. Extraction operations are usually either batch or semi-continuous. Wastewater discharges from extraction processes include spent raw materials, solvents used in extractions, and spills and equipment wash waters.

Chemical synthesis, either through batch or continuous processes (usually batch), is the most common method of preparing pharmaceuticals. Synthesis of pharmaceuticals involves reaction of the appropriate raw materials and recovery of the desired product. Effluents from synthesis operations are highly variable as are the processes by which they are generated. Process solutions, vessel wash waters, filtrates, concentrates, spent solvents, and scrubber effluents are all sources of wastewater. Pump seal water, spills, and cleaning wash waters are additional sources. Any of these sources may contain significant concentrations of volatile organics.

Mixing, compounding, and formulating operations involve preparation of the active ingredients into a dosage form for consumer use. The primary sources of wastewater from these processes are from equipment washings, scrubber effluents, and spills.

Although wastewater streams from all four processes have the potential to contain high organic loadings, fermentation and synthesis operations usually generate larger volumes of wastewater, and the wastewaters generated usually contain

higher organic loadings. Based on data gathering efforts by the Agency, the pharmaceutical manufacturing industry discharges significant quantities of organic compounds in their raw wastewaters.

A study by the Pharmaceutical Manufacturers' Association that focused on 26 member companies identified a total of 46 VOC's used by the industry.<sup>17</sup> These companies represent 53 percent of the domestic sales of prescription drugs. The industry primarily uses organic compounds as raw materials or solvents. An estimated 84 percent (i.e., 486,470 tons per year) of the organic compounds are recycled and 16 percent (i.e., 94,990 tons per year) are waste organics. Approximately 2.7 percent (i.e., 15,850 tons per year) of the waste organics are discharged to the sewer.

To better determine the total industry wastewater generation, the Agency estimated the contribution from the nonrespondents at 13 Mgal/d. The total wastewater flow, therefore, is approximately 93 Mgal/d.

Model streams representing the pharmaceutical manufacturing industry were developed from responses to a 1988 Section 308 survey conducted by OWRS. In the survey, OWRS collected information on wastewater flow rates and VOC concentrations. A total of eight responses provided sufficient information to allow the characterization of wastewater flow rate, VO concentration, and strippability. However, the available data did not present flow and concentrations for individual wastewater streams within each process unit. Therefore, combined process unit effluent streams were disaggregated into individual streams, as discussed in Section 2.2. Additional details regarding development of the pharmaceutical manufacturing industry model streams can be found in Appendix B.

## 2.5 HAZARDOUS WASTE TREATMENT, STORAGE, AND DISPOSAL FACILITIES INDUSTRY<sup>7</sup>

The EPA studied the TSDF industry in 1986 through both the Office of Water (OW) and the Office of Solid Waste (OSW).

The OW studied the industry in order to set effluent guidelines. The OSW, in accordance with Section 3018(a) of the Resource Conservation and Recovery Act (RCRA), identified TSDf (in that study, referred to as hazardous waste treaters [HWT]) as significant contributors of hazardous wastes to publicly owned treatment works (POTW). The Agency has placed very high priority on development of pretreatment standards for treaters of aqueous waste to control toxic and hazardous pollutants.

The Agency has divided the TSDf industry into three categories for effluent guideline purposes:

1. Landfills with leachate collection, including commercial (offsite) and industrial (onsite) hazardous waste (Subtitle C of RCRA) and municipal nonhazardous waste (Subtitle D of RCRA) landfills.

2. Hazardous waste incinerators with wet scrubbers (commercial and industrial); and

3. Facilities that treat aqueous hazardous waste, including commercial, industrial, and Federal (Subtitle C of RCRA) TSDf with and without categorical effluent regulations (technology-based effluent standards applicable to specific industries).

The Agency has identified 1,304 out of 1,909 facilities that would be subject to any effluent guideline regulations developed in the future. The industry characterization is presented in Table 2-5. Approximately 43 percent of these facilities are located in areas of ozone nonattainment.

Landfill leachates contain high concentrations of toxic organic compounds and metals, and conventional and nonconventional pollutants. Many organic compounds are in the range of 1 to 10 ppmw, a few at greater than 100 ppmw. Total mass in raw wastewater discharges of nonpriority organic compounds ranges from 1.8 to 4.7 times greater than organic priority compounds. (A priority compound is typically restricted to 126 pollutants as defined by the OWRS.) Of these, 29 are VOC's as defined by the EPA Purge and Trap



TABLE 2-5. HAZARDOUS WASTE TREATMENT, STORAGE, AND  
DISPOSAL FACILITIES INDUSTRY CHARACTERIZATION

<u>Facility type</u>	<u>Direct discharge</u>	<u>Indirect discharge</u>	<u>Other*</u>
Landfill leachate	173	355	383
Incinerator scrubber	137	27	109
Aqueous waste treaters	87	515	123
TOTAL	397	897	615

\* Includes offsite disposal at a commercial aqueous waste treatment facility, deep well injection, and other methods.

Method 624. This industry produces about 16 Mgal/d of landfill leachate.

Incinerator wet scrubber liquors contain high concentrations of toxic metals but very few organics at relatively low concentrations. Approximately 15 Mgal/d of incinerator wet scrubber liquors are produced.

Aqueous waste treatment facilities typically have high concentrations of toxic metals and organics. Many organic priority pollutants are found in concentrations greater than 1 ppmw, and some greater than 10 ppmw at the influent to the wastewater treatment plant. Total mass in raw wastewaters of nonpriority pollutant organics is approximately 7 times greater than that of organic priority pollutants. Aqueous waste treaters produce approximately 27 Mgal/d of wastewater.

Model streams representing TSDF's were developed from responses to a 1986 OSW survey under authority of Section 3007 of RCRA. In the survey, OSW collected information on wastewater flow rates and VOC concentrations. A total of four responses provided sufficient information to allow the characterization of wastewater flow rate, VOC concentration, and strippability. However, the available data did not present flow and concentrations for individual wastewater streams within each process unit. Therefore, combined process unit effluent streams were disaggregated into individual streams, as discussed in Section 2.2. Additional details regarding development of the TSDF model streams may be found in Appendix B.

## 2.6 PULP, PAPER AND PAPERBOARD AND BUILDERS' PAPER AND BOARD MILLS INDUSTRY

The OAQPS and the OWRS are currently coordinating standards for controlling releases from the pulp and paper industry. The OAQPS is developing a NESHAP to control air emissions of the HAP's listed in Title III of the CAA Amendments of 1990. The OWRS is developing effluent guideline limitations for control of specific pollutant discharges to receiving bodies of water.

The most recent data indicate that there are now 603 facilities in this industry. Approximately 43 percent of these facilities are located in areas of ozone nonattainment. Table 2-6 shows a breakdown of the facilities by subcategory as estimated in 1989.<sup>6</sup>

To accommodate industry diversity, the Agency developed three groupings based on the similarity in the mills, raw materials used, products manufactured, production processes employed, mill size, age, and treatment costs. These groups are:

- Integrated mills,
- Nonintegrated mills, and
- Secondary fibers mills.

Integrated mills manufacture paper products or market pulp from wood that is prepared, pulped, and bleached onsite. Some pulp may be purchased for blending with pulp produced onsite to achieve the desired paper properties. Nonintegrated mills manufacture paper products by blending purchased pulps to achieve the desired paper properties. The secondary fibers mills get their major fiber source from purchased wastepaper. Wastepaper is mildly cooked, bleached (if necessary) and possibly blended with purchased pulp to achieve desired paper properties.

The majority of the organics are formed in the pulping and bleaching of virgin pulp. For this reason, the integrated pulp and paper mills are most likely to generate waste streams with high organic loadings. Secondary fibers mills and nonintegrated mills do not generate wastewater with concentrations of organics as high as the streams generated in integrated mills. Approximately 2 percent of the kraft pulp and paper facilities are located in areas of ozone nonattainment.

During the pulping process, the lignin present in the wood is broken down into simpler organic compounds such as methanol and acetone. These soluble organics are washed from the pulp and are concentrated in the spent pulping liquor.

TABLE 2-6. MILL POPULATION

Subcategory	Estimate (1989)
Market kraft	14
Dissolving kraft	3
BCT kraft	8
Alkaline fine	24
Unbleached kraft & semi-chemical	8
Unbleached kraft - liner	21
Unbleached kraft - bag	5
Semi-chemical	16
Dissolving sulfite	6
Papergrade sulfite	11
Groundwood CMN	5
Groundwood fine	9
Groundwood TMP	7
Deink - fine	5
Deink - news	4
Deink - tissue	21
Tissue from wastepaper	19
Wastepaper-molded product	13
Paperboard from wastepaper	132
Builders' papers & roofing felts	21
NI - fine	35
NI - tissue	22
NI - lightweight	10
NI - electrical	4
NI - fine cotton	6
NI - filter nonwoven	13
NI - board	12
Misc. - integrated	91
Misc. - nonintegrated	38
Misc. - secondary fibers	20
<b>TOTAL:</b>	<b>603</b>

BCT = Bag carton tissue.

CMN = Chemical-mechanical pulping.

TMP = Thermal-mechanical pulping.

NI = Non-integrated.

In the recovery process of this pulping liquor, the organics are evaporated and condensed. The resulting condensate streams are rich in organics and are sometimes discharged to the sewer without treatment. Organics are also formed as additional lignin breaks down in the bleaching stages. In the presence of chlorine, chloroform and other chlorinated organics are formed and are washed from the pulp. These organics are readily volatilized from the bleach plant wash waters. Digester vent condensates, evaporator condensates, and bleach plant wash waters may contain high organic loadings. Some of the facilities visited by Agency representatives between 1989 and 1991 are using air strippers and steam strippers to lower organics concentration, biochemical oxygen demand (BOD), and/or total reduced sulfur (TRS) from their condensate streams; however, many condensate streams are still discharged to the sewer. In addition, no known controls are being used to control emissions of chlorinated compounds from the bleaching area.

Generally, the wastewaters in the pulp and paper industry typically have higher total suspended solids concentrations and pH values above 11 or below 3. These characteristics make the pulp and paper wastewaters less amenable to steam stripping with carbon steel equipment. However, as mentioned above, stainless steel steam and air strippers have been installed at some facilities to control TRS and BOD. One facility has installed a steam stripper to reduce TRS odor and BOD loading (primarily due to methanol concentrations) to their wastewater treatment plant.<sup>18</sup> The stripper receives evaporator, accumulator, and digester condensates, as well as turpentine decanter underflow for a total average flow of approximately 1,050 gallons per minute. The TRS and methanol concentrations are 480 and 4,820 ppm, respectively. The stripper achieves approximately a 90-percent reduction in methanol and a 98-percent reduction in TRS. The feed wastewater pH is approximately 9.5, thus the construction material is stainless steel.

Model streams representing condensate streams within the kraft pulp and paper industry were developed from responses to a 1990 questionnaire by OWRS issued under authority of the Clean Water Act, Section 308. This information was sufficient to allow the characterization of wastewater flow rate, VOC concentration, and strippability. Additional details regarding the development of the kraft pulp and paper industry condensate streams may be found in Appendix B.

## 2.7 REFERENCES

1. Office of Water Regulations and Standards.  
U. S. Environmental Protection Agency. Washington, DC.  
Development Document for Effluent Limitations Guidelines  
and Standards for the Organic Chemicals and Plastics and  
Synthetic Fibers Point Source Category. Volume I (BPT).  
EPA 440/1-83/009b (NTIS PB83-205633), February 1983.  
pp. 11 to 39, 94 to 96, 105 to 167, 195 to 198.
2. Office of Water Regulations and Standards.  
U. S. Environmental Protection Agency. Washington, DC.  
Development Document for Effluent Limitations Guidelines  
and Standards for the Organic Chemicals and Plastics and  
Synthetic Fibers Point Source Category Volume II (BAT).  
EPA 440/1-83/009b (NTIS PB83-205641), February 1983.  
pp. II-7 to II-15, III-1 to III-9, IV-10 to IV-28, V-1 to  
V-15, VII-1 to VII-22.
3. Office of Water Regulations and Standards.  
U. S. Environmental Protection Agency. Washington, DC.  
Development Document for Effluent Limitations Guidelines  
and Standards for the Pesticide Point Source Category.  
EPA 440/1-85/079 (NTIS PB86-150042/REB), October 1985.  
pp. III-9 to III-16, VI-1 to VI-47.
4. Office of Water. U. S. Environmental Protection Agency.  
Washington, DC. Development Document for Final Effluent  
Limitations Guidelines, New Source Performance Standards  
and Pretreatment Standards for the Pharmaceutical  
Manufacturing Point Source Category. EPA 440/1-83/084  
(NTIS PB84-180066/REB), September 1983. pp. 17 to 34, 49  
to 76, 103 to 138.
5. Office of Water Regulations and Standards.  
U. S. Environmental Protection Agency. Washington, DC.  
Development Document for Effluent Limitation Guidelines  
and Standards for the Pulp, Paper and Paperboard Builders  
Paper and Board Mills Point Source Category.  
EPA 440/1-82/025 (NTIS PB83-163949), October, 1982.  
pp. 77 to 87, 183 to 235, 363 to 385.
6. Meeting notes. Penny E. Lassiter, Environmental  
Protection Agency, Chemicals and Petroleum Branch, with  
Tom O'Farrell, Office of Water Regulations and Standards,  
Industrial Technology Division, March 3, 1989.
7. Office of Water Regulations and Standards.  
U. S. Environmental Protection Agency. Washington, DC.  
Draft Decision Document for Hazardous Waste Treatment  
Industry Effluent Guidelines Development.  
EPA Contract No.: 68-01-6947, August 17, 1987.

8. Office of Water Regulations and Standards.  
U. S. Environmental Protection Agency. Washington, DC.  
Development for Effluent Limitations Guidelines and  
Standards for the Petroleum Refining Point Source  
Category. EPA 440/1-82/014 (NTIS). October 1982.
9. U. S. Environmental Protection Agency. Washington, DC.  
VOC Emissions From Petroleum Refinery Wastewater Systems--  
Background Information for Proposed Standards.  
EPA 450/3-85-001a. February, 1985.
10. U. S. Environmental Protection Agency. Washington, DC.  
Final NESHAP Standards for Waste Operations: Basis for  
Impact Calculations. February 1990.
11. Annual Refining Survey. Oil and Gas Journal, March 26,  
1990.
12. Federal Register. OCPSF Effluent Limitations Guidelines,  
Final Rule. 52 FR 42522. November 5, 1987.
13. Federal Register. Effluent Guidelines Plan. 55 FR 80.  
January 2, 1990.
14. Memorandum from Brailsford, J.C., Radian Corporation, to  
Industrial Wastewater file. Percent Ozone Nonattainment  
Calculations. January 29, 1992.
15. Memorandum from Bagley, C., Radian Corporation, to F. E.  
Manning, U. S. Environmental Protection Agency.  
Development of Volatile Organic Wastewater Loading  
Distribution from Responses to the March 1990 Section 114  
Wastewater Questionnaire. May 5, 1992.
16. Federal Register. Pesticide Chemicals Category Effluent  
Limitations Guidelines, Final Rule. 50 FR 40674.  
October 4, 1985.
17. Office of Air Quality Planning and Standards.  
U. S. Environmental Protection Agency. Research Triangle  
Park, North Carolina. Control of Volatile Organic  
Emissions from Manufacture of Synthesized Pharmaceutical  
Products, OAQPS Guideline Series, EPA-450/2-78-029  
(NTIS PB290-580/0), December 1978.
18. BOD<sub>5</sub> Reduction Using Condensate Stripping, Union Camp  
Corporation, Franklin, Virginia. Submitted in a letter  
from David H. Breed, Union Camp, to Susan Wyatt,  
U. S. Environmental Protection Agency, November 17, 1989.



### 3.0 VOLATILE ORGANIC COMPOUND EMISSIONS DURING WASTEWATER COLLECTION AND TREATMENT

Facilities in the industries discussed in Chapter 2.0 generate wastewater streams that contain organic compounds. These wastewaters are collected and treated in a variety of ways. Some of these collection and treatment steps result in the emission of volatile organic compounds (VOC's) from the wastewater to the air. This chapter provides a discussion of the potential VOC emissions from wastewater sources and presents estimates of emissions for model systems.

Section 3.1 describes the sources of organic compound-containing wastewater. Section 3.2 describes the sources of VOC emissions from the wastewater streams and factors affecting emissions from these sources. Procedures for estimating VOC emissions are discussed in Section 3.3.

#### 3.1 SOURCES OF ORGANIC COMPOUND-CONTAINING WASTEWATER

The industries discussed in Chapter 2.0 differ in structure and manufacture a wide variety of products. However, many of the chemical processes employed within these industries use similar organic compounds as raw materials, solvents, catalysts, and extractants. In addition, many of these processes also generate similar organic products and byproducts during reaction steps. Consequently, many of the wastewater streams generated by the targeted industries are similar in organic compound content. These organic compound-containing wastewater streams result from the direct contact of water with organic compounds and from contamination of indirect contact wastewater through equipment leaks in chemical processing.

### 3.1.1 Direct Contact Wastewater

Water comes in direct contact with organic compounds through many different chemical processing steps, resulting in wastewater streams that must be discharged for treatment or disposal. Direct contact wastewater includes:

- Water used to wash impurities from organic compound products or reactants;
- Water used to cool or quench organic compound vapor streams;
- Condensed steam from jet eductor systems pulling vacuum on vessels containing organic compounds;
- Water from raw material and product storage tanks;
- Water used as a carrier for catalysts and neutralizing agents (e.g., caustic solutions); and
- Water formed as a byproduct during reaction steps.

Two additional types of direct contact wastewater are landfill leachate and water used in equipment washes and spill cleanups. This wastewater is normally more variable in flow rate and concentration than the streams previously discussed, and it may be collected for treatment differently from the wastewater streams discharged from process equipment such as scrubbers, decanters, evaporators, distillation columns, reactors, and mixing vessels.

### 3.1.2 Indirect Contact Wastewater

Wastewater streams that are not intended to come in contact with organic compounds in the process equipment but become contaminated with organic compounds through equipment leaks are defined as "indirect contact" wastewater. Noncontact wastewater may become contaminated as a result of leaks from heat exchangers, condensers, and pumps. These indirect contact wastewaters may be collected and treated differently from direct contact wastewaters. Pump seal water is normally collected in area drains that tie into the process wastewater collection system. This wastewater is then combined with direct contact wastewater and transported to the wastewater treatment plant. Wastewater contaminated from heat exchanger leaks is often collected in different systems and

may bypass some of the treatment steps used in the treatment plant. The organic compound content in these streams can be minimized by implementing an aggressive leak detection program.

### 3.2 SOURCES OF AIR EMISSIONS

Wastewater streams are collected and treated in a variety of ways. Generally, wastewater passes through a series of collection and treatment units before being discharged from a facility. Many of these collection and treatment system units are open to the atmosphere and allow organic compound-containing wastewaters to contact ambient air, thus creating a potential for VOC emissions. The organic pollutants volatilize in reaching an equilibrium with the vapor phase above the wastewater. These organic compounds are emitted to the ambient air surrounding the collection and treatment units. The magnitude of VOC emissions is somewhat dependent on factors such as the physical properties of the pollutants, the temperature of the wastewater, and the design of the individual collection and treatment units.

Collection and treatment schemes for wastewater are facility specific. The flow rate and organic compound composition of wastewater streams at a particular facility are functions of the processes used and influence the sizes and types of collection and treatment units that must be employed. Table 3-1 lists the potential sources of emissions in facility collection and treatment systems. The following sections briefly discuss each of these emission sources. A detailed discussion of each emission source, including diagrams, typical design parameters, emission mechanisms, factors affecting emissions, emission estimation models, and example calculations for VOC emissions estimated for each source is contained in the Wastewater CTC Document.<sup>1</sup>

#### 3.2.1 Drains

Wastewater streams from various sources throughout a given process are introduced into the collection system through process drains. Individual drains usually connect

TABLE 3-1. EMISSION SOURCES IN WASTEWATER COLLECTION  
AND TREATMENT SYSTEMS

---

---

Drains  
Manholes  
Junction boxes  
Lift stations  
Trenches  
Sumps  
Weirs  
Oil/water separators  
Equalization basins or neutralization  
basins  
Clarifiers  
Aeration basins  
pH adjustment tanks  
Flocculation tanks  
Surface impoundments

---

---

directly to the main process sewer line, but may also drain to trenches, sumps, or ditches. Some drains are dedicated to a single piece of equipment, while others, known as area drains, serve several sources. Many of these drains are open to the atmosphere; that is, they are not equipped with a water seal pot or p-trap to reduce emissions of organic compounds to the atmosphere.

Emissions from drains occur by diffusive and convective mechanisms.<sup>2</sup> Drain emission rates are affected by a number of factors. These factors include the composition and physical properties of the organic compounds in wastewater entering the drain and flowing through the sewer line below the drain, the temperature of the wastewater, the design characteristics of the drain, and climatic factors.<sup>2</sup> Drain design characteristics that affect emissions are the diameter and length of the drain riser. Climatic factors that may have an effect on VOC emissions from a drain include ambient air temperature and wind speed and direction.

### 3.2.2 Manholes

Manholes are service entrances into process sewer lines that permit inspection and cleaning of the sewer line. They are placed at periodic lengths along the sewer line or where sewers intersect or change significantly in direction, grade, or sewer line diameter. The lower portion of a manhole is usually cylindrical, with a typical inside diameter of 1.2 meters (m) (4 feet [ft]) to allow adequate space for workers. The upper portion tapers to the diameter of the opening at ground level. A typical manhole opening is about 0.6 m (2 ft) in diameter and covered with a heavy cast-iron plate, which usually contains two to four holes so that the manhole cover can be grasped for removal.

As with drains, emissions from manholes occur by diffusive and convective mechanisms. Emission rates from manholes are affected by several factors, including the characteristics of the wastewater passing through the sewer line below the manhole, the manhole design characteristics,

and climatic factors. Wastewater characteristics affecting emission rates include wastewater composition and temperature.

Manhole design characteristics that affect emission rates include the manhole diameter, the distance from the manhole cover down to the sewer line, the thickness of the manhole cover, and the number and diameter of the vent holes in the manhole cover. Climatic factors that affect emission rates from manholes include ambient air temperature and wind speed and direction.

### 3.2.3 Junction Boxes

A junction box combines multiple wastewater streams into one stream that flows downstream from the junction box. Generally, the flow rate from the junction box is controlled by the liquid level in the junction box. Junction boxes are either square or rectangular and are sized based on the total flow rate of the entering streams. Junction boxes are typically open, but for safety reasons may be closed and vented to the atmosphere.

Emissions occur from junction boxes predominantly by convective mass transfer. Organic compounds in the wastewater volatilize into the ambient air just above the liquid surface in an attempt to reach equilibrium between the liquid and vapor phases. Since the organic compound vapors above the liquid are in contact with the ambient air, these organic compound vapors can be swept into the atmosphere by wind blowing across the top of the junction box. Emission rates from junction boxes are affected by several factors, including the characteristics of the wastewater flowing through the junction box, the design of the junction box, and climatic factors.<sup>3</sup>

Junction box design characteristics that affect emissions include the fetch-to-depth ratio, the water turbulence in the junction box, and the liquid surface area. Fetch is defined as the linear distance across the junction box in the direction of the wind flow. Depth is represented by the average liquid level in the junction box.

Water turbulence enhances liquid phase mass transfer.<sup>3</sup> In completely smooth flow through the junction boxes, pollutants slowly diffuse to the water surface to replace the volatilizing pollutants. In turbulent flow through the junction box, the organic compounds are carried much more rapidly to the surface by the turbulent water. Therefore, more organic compounds are exposed to the surface air, and the emission rate is increased. If the sewer lines feed water to the junction box above the liquid surface, the exposure of organic compounds to the surface air is also increased. The water spills into the junction box, causing splashing and additional turbulence at the liquid surface, which increases emissions. In addition, wind entering the sewer system through an upstream component may exit the junction box saturated with organic compounds. These effects can be minimized by introducing water to the junction box below the liquid surface. Ambient wind speed is the predominant climatic factor affecting air emissions.

#### 3.2.4 Lift Stations

Lift stations are usually the last collection unit before the treatment system. They accept wastewater from one or several sewer lines. The main function of the lift station is to collect wastewater for transport to the treatment system. A pump provides the necessary head pressure for transport and is generally designed to turn on and off in response to preset high and low liquid levels. Lift stations are usually rectangular in shape and greater in depth than length or width. Lift stations are typically open or closed and vented to the atmosphere.

As with junction boxes, emissions occur from lift stations predominantly by convective mass transfer. The factors affecting emissions from lift stations are similar to the factors affecting emissions from junction boxes discussed in Section 3.2.3. These factors are the concentration and physical properties of the organic compounds present in the

wastewater, lift station design characteristics, and climatic factors.

The design characteristics that affect air emission rates from lift stations include the liquid surface area, the water turbulence in the lift station, and the fetch-to-depth ratio. The predominant climatic factor affecting emissions from lift stations is ambient wind speed.

### 3.2.5 Trenches

Trenches are used to transport wastewater from the point of discharge from the process equipment to wastewater collection units such as junction boxes and lift stations. In older plants, trenches are often the primary mode of wastewater transportation in the collection system. Trenches are often interconnected throughout the process area and handle equipment pad water runoff, water from equipment wash downs and spill cleanups, and process wastewater discharges. Trench length is determined by the locations of the process equipment and the downstream collection system units and typically ranges from 15 to 150 m (50 to 500 ft). Depth and width are dictated by the rate at which wastewater is discharged from process equipment and must be sufficient to accommodate emergency wastewater flows from the process equipment. Trenches are typically open or covered with grates.

As with junction boxes and lift stations, emissions from trenches occur predominantly by convective mass transfer. Factors that affect emissions from trenches are the concentration and physical properties of the compounds in the wastewater, trench design characteristics, and climatic factors.

The trench design characteristics that affect emission rate include the depth and width of the trench and the hydraulic retention time. As with junction boxes and lift stations, wind speed is the predominant climatic factor affecting emissions.



### 3.2.6 Sumps

Sumps are used to collect and equalize wastewater flow from trenches before treatment. They are usually quiescent and open to the atmosphere. Sumps are sized based on the total flow rate of the incoming wastewater stream. Typical diameters and depths are approximately 1.5 m (5 ft).

Emissions occur from sumps by both diffusive and convective mechanisms. As wastewater flows slowly through the sump, organic compounds diffuse through the water to the liquid surface. These organic compounds volatilize into the ambient air above the liquid and can be swept into the air by wind blowing across the surface of the sump.

The factors affecting emissions from a sump are similar to the factors affecting emissions from an equalization basin. These factors include wastewater characteristics, wind speed, and sump design characteristics. Design characteristics that affect air emission rates from sumps are the fetch-to-depth ratio, the liquid surface area, and the hydraulic retention time.

### 3.2.7 Weirs

Weirs act as dams in open channels. The weir face is usually aligned perpendicular to the bed and walls of the channel. Water from the channel normally overflows the weir but may pass through a notch, or opening, in the weir face. Because of this configuration, weirs provide some control of the level and flow rate through the channel. Weirs may also be used for wastewater flow rate measurement.

Water overflowing the weir may proceed down stair steps that serve to aerate the wastewater. This design increases diffusion of oxygen into the water which may benefit the biodegradation process (often the next treatment step). However, this increased contact with air also accelerates the volatilization of organic compounds contained in the wastewater.

The major factors affecting emissions from weirs include wastewater characteristics, ambient wind speed, and weir design characteristics. The concentration and physical

properties of the organic compounds in the wastewater have a significant effect on VOC emissions. The diffusivity in water of the specific organic compounds present in the wastewater may be the most significant physical property.

Ambient wind speed has a significant effect on convective mass transfer, because as the wastewater spills over the weir and splashes down the stair steps, increased liquid surface area is exposed.

The height of the weir is the most significant design characteristic affecting emissions. Typical weir heights range from 0.9 to 2.7 m (3 to 9 ft).

### 3.2.8 Oil/Water Separators

Oil/water separation is often the first step in wastewater treatment, but oil/water separators may also be found in the process area. These units gravity separate and remove oils, scum, and solids from the wastewater. Most of the separation occurs as the wastewater stream passes through a quiescent zone in the unit. Oils and scum with specific gravities less than water float to the top of the aqueous phase. Heavier solids sink to the bottom. Some of the organic compounds contained in the wastewater will partition to the oil phase and can be removed with the skimmed oil leaving the separator.

Volatilization of organic compounds from the surface of an oil/water separator is a complex mass transfer phenomenon. The force behind volatilization is the drive to reach equilibrium between the concentration of organic compounds in the oil layer and the vapor phase just above this layer. Organic compounds volatilizing into the vapor phase either diffuse or are swept by wind into the ambient air surrounding the oil/water separator.

Factors affecting emissions from oil/water separators include characteristics of the wastewater and oil layers, ambient wind speed, and design characteristics of the separator.<sup>4</sup> The concentration and physical properties of the organic compounds contained in the wastewater significantly

affect emissions. The thickness of the oil layer also affects emissions since organic compounds that partition from the wastewater into the oil phase must diffuse through the oil layer to volatilize.

Ambient air speed above the oil surface affects convective mass transfer into the ambient air. Design characteristics affecting emissions include the length and width of the oil/water separator.

### 3.2.9 Equalization Basins

Equalization basins are used to reduce fluctuations in the wastewater temperature, flow rate, and organic compound concentrations to the downstream treatment processes. Equalization of wastewater flow rate results in more uniform effluent quality from downstream units and can benefit biological treatment performance by damping any influent concentration and flow rate fluctuations. This damping protects biological processes from upset or failure due to shock loadings of toxic or treatment-inhibiting compounds. Equalization basins normally use hydraulic retention time to ensure equalization of the wastewater effluent leaving the basin. However, some basins are equipped with mixers or surface aerators to enhance the equalization, accelerate wastewater cooling, or saturate the wastewater with oxygen before secondary treatment.

Emissions occur from equalization basins by both diffusive and convective mechanisms.<sup>3</sup> Factors affecting emissions from equalization basins are similar to the factors affecting emissions from other well-mixed, flow-through impoundments. These factors are wastewater characteristics, wind speed, and equalization basin design characteristics. Design characteristics that affect air emission rates from equalization basins are the fetch-to-depth ratio, the liquid surface area, the hydraulic retention time, and the degree of aeration.

### 3.2.10 Clarifiers

The primary purpose of a clarifier is to separate solids from the wastewater through gravitational settling. Most clarifiers are equipped with surface skimmers to clear the water of floating oil deposits, grease, and scum. Clarifiers also have sludge raking arms that remove the accumulation of organic solids collected at the bottom of the tank.<sup>3</sup> The depth and cross-sectional area of a clarifier are functions of the settling rate of the suspended solids and the thickening characteristics of the sludge. Clarifiers are designed to provide sufficient retention time for the settling and thickening of these solids.

Emissions occur from clarifiers by both diffusive and convective mechanisms.<sup>3</sup> The factors affecting emissions from a clarifier are similar to the factors affecting emissions from other well-mixed, flow-through impoundments.<sup>3</sup> These factors include wastewater characteristics, wind speed, and clarifier design characteristics. Design characteristics that affect emission rates from clarifiers are the liquid surface area, the fetch-to-depth ratio, and the hydraulic retention time.

### 3.2.11 Aeration Basins

Biological waste treatment is normally accomplished through the use of aeration basins. Microorganisms require oxygen to carry out the biodegradation of organic compounds, which results in energy and biomass production. The aerobic environment in the basin is normally achieved with diffused or mechanical aeration. This aeration also serves to maintain the biomass in a well-mixed regime. The performance of aeration basins is particularly affected by: (1) mass of organic compound per unit area of wastewater; (2) temperature and wind patterns; (3) hydraulic retention time; (4) dispersion and mixing characteristics; (5) sunlight energy; and (6) amount of essential microbial nutrients present.

Three mechanisms affect the removal of organic compounds in aeration basins. These mechanisms are biodegradation, adsorption onto the sludge, and air emissions.<sup>3</sup> Because these three mechanisms compete against each other, factors affecting the biodegradation and adsorption mechanisms will have an effect on air emissions.

Typically, aeration basins are equipped with aerators to introduce oxygen into the wastewater. The biomass uses this oxygen in the process of biodegrading the organic compounds. However, aeration of wastewater also affects air emissions.

Other factors affecting emissions from aeration basins include wind speed and basin design characteristics. Emissions from aeration basins are not as sensitive to wind speed effects compared to quiescent basins. Basin design characteristics that affect emissions include the quiescent and turbulent surface areas, the depth of the basin, the design of the aerators, and the hydraulic retention time of the basin.

#### 3.2.12 Treatment Tanks

Several different types of treatment tanks may be used in wastewater treatment systems. Tanks designed for pH adjustment typically precede the biological treatment step. In these tanks, the wastewater pH is adjusted, using acidic or alkaline additives, to prevent shocking the biological system downstream. Flocculation tanks are typically used to treat wastewater after biological treatment. Flocculating agents are added to the wastewater to promote formation or agglomeration of larger particle masses from the fine solids formed during biological treatment. In the clarifier, which usually follows the flocculation tanks in the system, these larger particles precipitate more readily out of the wastewater.

Emissions occur from treatment tanks by both diffusive and convective mechanisms. Factors affecting emissions from a treatment tank are similar to the factors affecting emissions from other well-mixed, flow-through impoundments. These

factors are the wastewater characteristics, wind speed, and design characteristics of the treatment tank. Design characteristics of the treatment tanks that affect emission rates are the liquid surface area, the fetch-to-depth ratio, and the hydraulic retention time.

### 3.2.13 Surface Impoundments

Surface impoundments are used for evaporation, polishing, storage before further treatment or disposal, equalization, leachate collection, and as emergency surge basins. They may be quiescent or mechanically agitated.

Resource Conservation and Recovery Act (RCRA) Subtitle D Surface Impoundments are impoundments that accept wastes as defined under Subtitle D of RCRA.<sup>5</sup> Subtitle D wastes are all solid wastes regulated under the RCRA that are not subject to hazardous waste regulations under Subtitle C. These wastes are defined in 40 CFR Part 257. Specifically, this document applies to process wastewater produced by generators; small quantity generators; publicly owned treatment works (POTW); and treatment, storage, and disposal facilities (TSDF) that is RCRA Subtitle D waste as defined in 40 CFR 257.

Emissions occur from surface impoundments by both diffusive and convective mechanisms. Factors affecting emissions from a surface impoundment are similar to the factors affecting emissions from equalization basins if the impoundment is quiescent and similar to factors affecting emissions from aeration basins if the impoundment is agitated. Emission factor development for a surface impoundment will vary depending on the impoundment's purpose and design. All characteristics of the impoundment should be reviewed to determine what type of collection or treatment system it best resembles.

### 3.3 VOLATILE ORGANIC COMPOUND EMISSION ESTIMATION

Emissions of VOC's from industrial wastewater depend on both wastewater characteristics and wastewater collection and treatment system configurations. Characteristics of wastewater generated by facilities in the six affected

industries are described in Chapter 2.0, Sections 2.1 through 2.6, with additional details and example wastewater streams presented in Appendix B. Wastewater collection and treatment system configurations vary across facilities, and even for streams within a facility. Because of the many factors that affect the general scheme used to collect and treat facility wastewater, it is not possible to develop model wastewater collection and treatment schematics representing all possible scenarios. Instead, three example waste stream collection and treatment schemes were developed in the Wastewater CTC Document<sup>1</sup> to evaluate potential ranges in emissions from different facilities. The collection and treatment system schematics were chosen to represent a range of emission potentials.

For purposes of comparison, emissions were estimated for an example wastewater stream with the same flow rate and organic compound composition flowing through each example schematic. To demonstrate a range of emission potentials, this example wastewater stream was designed to contain compounds that span the range of volatilities. Emissions were estimated from the collection and treatment units in each of the three example waste stream systems using techniques presented in Appendix A of the Wastewater CTC Document.<sup>1</sup> The cumulative fraction emitted (fe) was calculated for each of the five model compounds in each of the three schematics.<sup>6</sup> It was determined that the following relationship exists between the average overall fe for the three schematics and the Henry's Law constant for an individual compound:

$$fe = 1.061 + 6.546 * 10^{-2} * \ln(H\text{-Law})$$

The above equation is the basis for estimating VOC emissions from wastewater streams using the following equation:

$$\text{VOC Emissions (Mg/yr)} = \text{VOC Concentration (mg/L)} * \text{Flow (lpm)} * 10^{-9} \text{ Mg/mg} * 60 \text{ min/hr} * 8,760 \text{ hr/yr} * fe$$

where:

VOC Concentration = total VOC concentration in the  
wastewater

$f_e$  = the fraction of the total VOC  
concentration emitted to the air

This relationship was used in estimating model wastewater stream VOC emissions as described in Appendix B. In addition to an explanation of the calculations, Tables B-13 through B-18 in Appendix B present the VOC emissions estimated for each of the industries.



### 3.4 REFERENCES

1. Office of Air Quality Planning and Standards, U. S. Environmental Protection Agency. Research Triangle Park, North Carolina. Industrial Wastewater Volatile Organic Compound Emissions--Background Information for BACT/LAER Determinations. EPA 450/3-90-004. January 1990.
2. Office of Air Quality Planning and Standards, U. S. Environmental Protection Agency. Research Triangle Park, North Carolina. VOC (Volatile Organic Compound) Emissions from Petroleum Refinery Wastewater Systems-- Background Information for Proposed Standards, Draft EIS. EPA-450/3-85-001a (NTIS PB87-190335), February 1985.
3. Office of Air Quality, Planning and Standards. U. S. Environmental Protection Agency. Hazardous Waste Treatment, Storage, and Disposal Facilities (TSDF)--Air Emission Models, Documentation. EPA/450/3-87/026. December, 1987.
4. Liang, S.F. Hydrocarbon Losses by Atmospheric Evaporation from Open Separators, Technical Progress Report, BRC-CORP 24-73-F. (Shell Models). 1973
5. Office of Solid Waste and Emergency Response. U. S. Environmental Protection Agency. Washington, DC. Subtitle D Study Phase I Report. EPA-530-SW-86-054, October 1986.
6. Memorandum from Zukor, C.J., Radian Corporation, to P.E. Lassiter, U. S. Environmental Protection Agency. Approach for the Estimation of Uncontrolled Emissions of Hazardous Air Pollutants from Wastewater Streams in the HON. January 20, 1992.

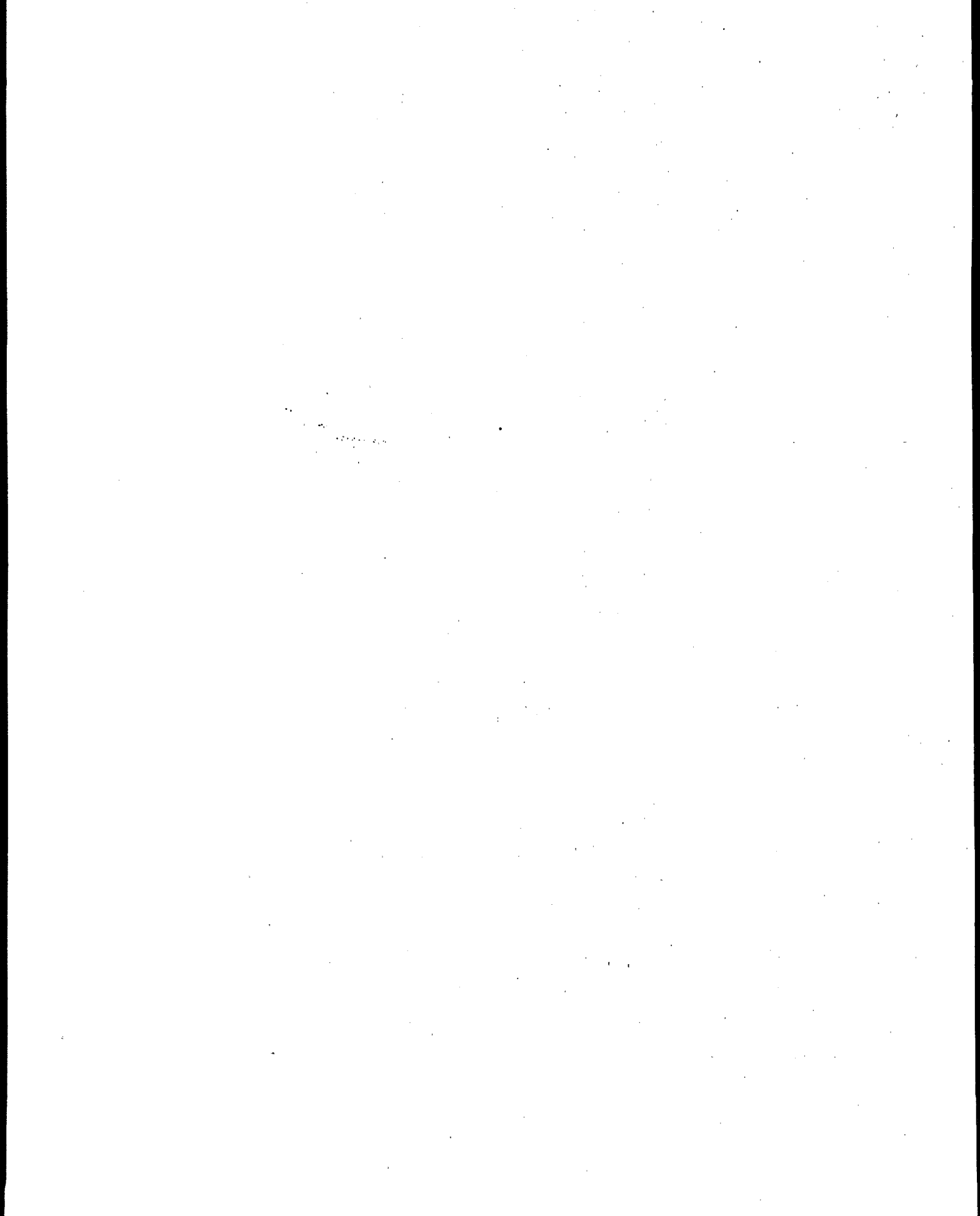

#### 4.0 VOLATILE ORGANIC COMPOUND EMISSION CONTROL TECHNIQUES

As discussed in Chapter 3.0, volatile organic compound (VOC) emissions during collection and treatment of industrial wastewater can be significant, and measures to control these emissions should be considered. This chapter describes control measures that can be applied to reduce these VOC emissions. Two control strategies are discussed in this chapter. The first control strategy is waste minimization through process modifications, modification of operating practices, preventive maintenance, recycling, or segregation of waste streams. The second control strategy is to reduce the organic compound content of the wastewater through treatment before the stream contacts ambient air. A complete strategy for reducing the organic compound content of the wastewater includes: (1) suppression of emissions from collection and treatment system components by hard piping or enclosing the existing wastewater collection system up to the point of treatment; (2) treatment of the wastewater to remove organic compounds; and (3) treatment of residuals. Residuals include oil phases, condensates, and sludges from nondestructive treatment units. Each of these steps is essential to the effective reduction of VOC emissions.

The purpose of this chapter is to present and discuss the two emission control strategies. A general discussion of the application of waste minimization to control VOC emissions from industrial wastewaters is presented in Section 4.1. Section 4.2 presents a discussion of organic compound treatment technologies, including steam stripping and biological destruction. Section 4.3 presents VOC emission suppression techniques for collection and treatment system

components. Add-on control devices are discussed in Section 4.4.

#### 4.1 WASTE MINIMIZATION

Waste minimization is a general term that includes both source reduction and recycling. Source reduction refers to reduction or elimination of the generation of a specific waste at the source. This may be accomplished through process or equipment modifications, stream segregation, or changes in work practices. Recycling includes recovery and/or reuse of potential waste streams. Waste minimization must be implemented on a process-specific basis. However, implementation of an aggressive waste minimization program can be an effective method of reducing emissions of VOC from industrial wastewaters.

Although many of the specific techniques that can be applied to minimize waste generation are specific to one application, the implementation of any waste minimization program should follow the guidelines presented below. By following these guidelines, the most effective steps can be identified and implemented.

##### 4.1.1 Gather Baseline Data

The first step in any waste minimization program should be to identify and characterize the individual waste streams. This should include flow rate, composition, pH, and solids content of the wastewater streams. Although some of these data might need to be gathered through a sampling program, some of them may be available from hazardous waste manifests, Superfund Amendments and Reauthorization Act (SARA) Title III Section 313 release reporting calculations, permits, monitoring reports, product and raw material specifications, and other internal records.

##### 4.1.2 Identify and Rank Sources for Reduction

Using the baseline data gathered, a cost allocation system should be developed to assess treatment and disposal costs of individual waste streams. Future treatment and disposal costs should be considered in this evaluation, as should potential liabilities associated with the waste

handling and subsequent treatment and disposal. Once the waste streams have been ranked and prioritized, methods for controlling these streams can be considered.

#### 4.1.3 Implementation of Reduction/Recycling

In selecting the appropriate method for reducing or eliminating a wastewater stream, a variety of sources of information can be used. The Agency's Pollution Prevention Information Clearinghouse (PPIC), supported by the Pollution Prevention Office, contains information on case studies and reports on pollution prevention. The PPIC can be accessed by telephone hotline (202-382-3000). Other valuable sources of information are State assistance programs, vendors, and consultants.

As waste minimization steps are implemented, it is important that good recordkeeping be continued to document which steps were effective and which ones failed. Good records are especially important because future regulations may require percentage reductions in wastes generated. To receive credit for reductions, facilities will be required to provide documentation regarding the quantitative impacts of the waste reduction programs (reduction in VOC emissions, reduction of wastewater flow, etc.). Although some wastewater streams will still be generated, an effective waste minimization program may allow more cost-effective handling of these streams.

### 4.2 ORGANIC COMPOUND TREATMENT TECHNOLOGIES

#### 4.2.1 Steam Stripping

Steam stripping is a proven technology that involves the fractional distillation of wastewater to remove organic compounds. The basic operating principle of steam stripping is the direct contact of wastewater with steam. This contact provides heat for vaporization of the more volatile organic compounds. The overhead vapor, containing water and organic compounds, is condensed and separated (usually in a decanter) to recover the organic compounds. These recovered organics are usually either recycled to the process or incinerated in an onsite combustion device.

4.2.1.1 Steam Stripper Process Description. Steam stripper systems may be operated in a batch or continuous mode. Batch steam strippers are generally more prevalent when the wastewater feed is generated by batch processes, when the characteristics of the feed are highly variable, or when small volumes of wastewater are generated. A more detailed discussion of the operating and design considerations of batch steam stripper systems is contained in the Wastewater CTC Document.<sup>1</sup>

In contrast to batch steam strippers, continuous steam strippers are generally designed to treat wastewater streams that are continuously discharged from process equipment and are relatively consistent in composition. However, batch wastewater streams can also be controlled by continuous steam strippers by incorporating a feed tank with adequate residence time to provide a relatively consistent outlet composition. For these reasons, the remaining discussion focuses on a continuous steam stripping system.

Figure 4-1 presents a continuous steam stripping system that can be designed and operated to achieve high organic compound removal efficiencies for most wastewater streams. The design and operating conditions for a steam stripper system with an assumed feed rate of 300 liters per minute (lpm) (80 gallons per minute [gal/min]) is presented in Table 4-1. The steam stripping system includes an enclosed wastewater collection up to a covered feed tank, the steam stripping tower, and controls on tank and condenser vents associated with the steam stripping system. In Figure 4-1, the noncondensables are vented to the feed storage tank, which is routed to a control device. Each of these steam stripper system components are discussed briefly in the following sections; additional discussion on these components can be found in the Wastewater CTC Document.<sup>1</sup>

4.2.1.1.1 Wastewater collection and conditioning. The controlled sewer system, or hard piping from the point of wastewater generation to the feed tank, controls emissions

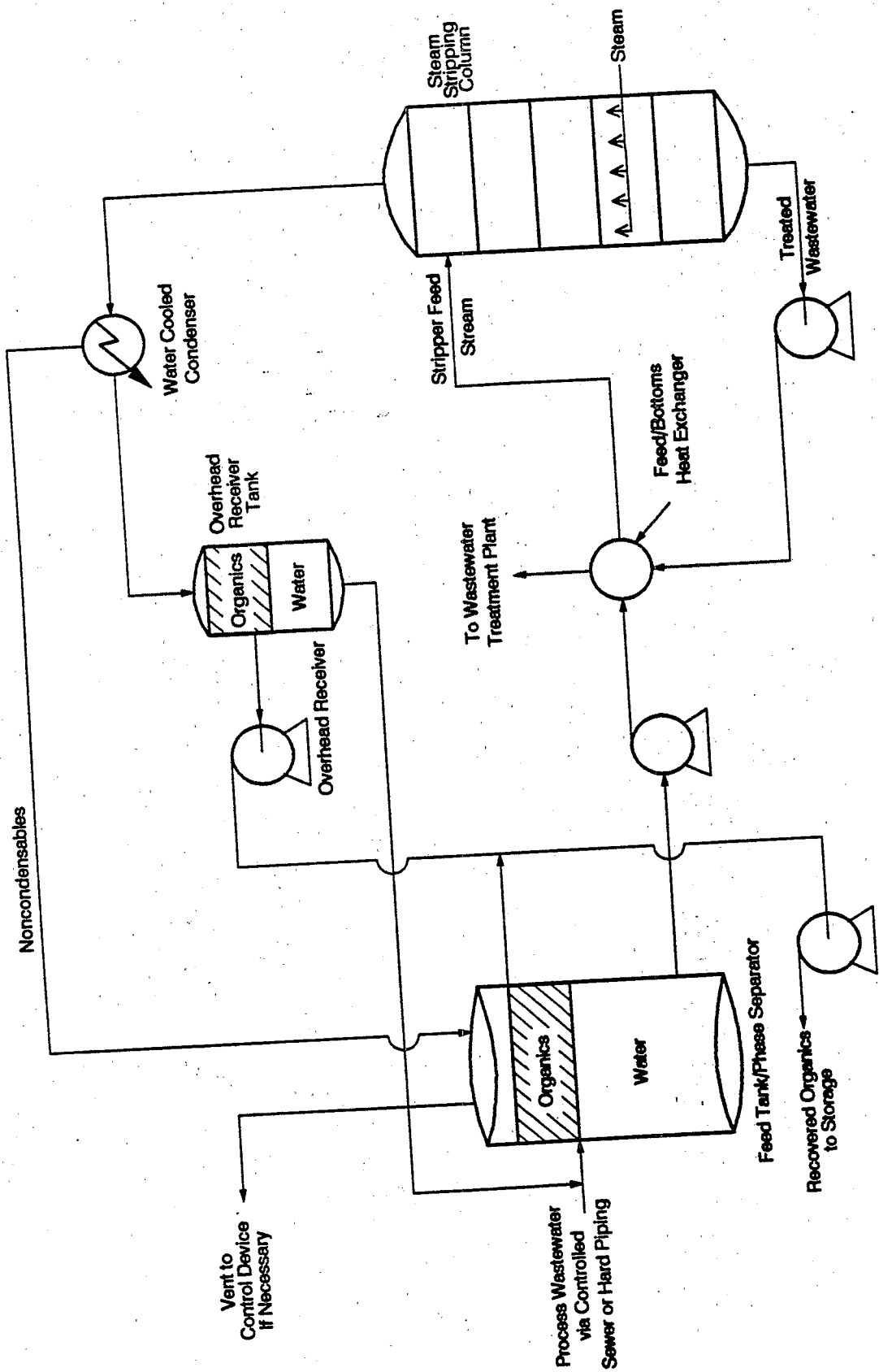

28036282R

Figure 4-1. Continuous steam stripper system.

TABLE 4-1. DESIGN AND OPERATING BASIS FOR THE STEAM STRIPPING SYSTEM

1. Wastewater stream content: water = 99.75%  
total organics = 0.25% (2,500 ppm)

2. Wastewater stream organic composition:

Organic compound	Organic compound Henry's Law value (atm-m <sup>3</sup> /gmol) at 25 °C	Waste stream organic conc. (ppmw)	% Removal in stripper f <sub>r</sub> <sup>a</sup>
Butadiene	1.42 x 10 <sup>-1</sup>	500	100
Toluene	6.68 x 10 <sup>-3</sup>	500	100
Naphthalene	1.18 x 10 <sup>-3</sup>	500	100
Butanol	8.90 x 10 <sup>-6</sup>	500	92
Phenol	4.54 x 10 <sup>-7</sup>	500	8.9

3. Wastewater flow: 300 l/min
4. Stripper operating period: 24 hr/day x 300 day/yr = 7,200 hr/yr
5. Wastewater storage: Wastewater feed collection tank with 48-hour retention time.
6. Steam stripping column:  
Configuration: countercurrent flow, 9.0 m sieve tray column  
Steam flow rate: 0.096 kg of steam/l of waste feed  
Wastewater feed temperature: 35 °C  
Column diameter: 0.76 m  
Active column height: 6.5 m  
Total column height: 9.0 m  
Liquid loading: 39,900 l/hr/m<sup>2</sup>
7. Condenser:  
Configuration: water-cooled  
Primary condenser outlet vapor temperature: 50 °C
8. Overhead control: vent to existing onsite combustion or other control device.
9. Bottoms control: feed to existing onsite wastewater treatment facility or publicly owned treatment works.

<sup>a</sup>Removal efficiency was estimated using ASPEN.<sup>2</sup> Benzene was the chosen design compound.



before steam stripping. Section 4.3 presents VOC emission suppression techniques for wastewater collection and treatment system components. The feed tank, which is covered and vented to an onsite combustion device, collects and conditions the wastewater fed to the steam stripper. The feed tank is sized to provide a hydraulic retention time of 48 hours, which is conservatively high. The desired retention time depends primarily on the variability in wastewater flow rate, characteristics of the inlet wastewater, and the amount of wastewater conditioning needed (i.e., separation of aqueous and organic phases, settling of solids). Additional surge capacity can provide retention time for wastewater streams with highly variable flow rates (including batch flow streams) to maintain a relatively constant feed rate to the stripper.

4.2.1.1.2 Wastewater steam stripping. After the wastewater is collected and conditioned, it is pumped through the feed/bottoms heat exchanger and into the top of the steam stripping column. Steam is sparged directly into the stripper at the bottom of the column, and as the wastewater flows down the column it contacts the steam countercurrently. Latent and sensible heat is transferred from the steam to the organic compounds in the wastewater, vaporizing them into the vapor stream. These constituents flow out the top of the column with any uncondensed steam. The wastewater effluent leaving the bottom of the steam stripper is pumped through the feed/bottom heat exchanger to heat the feed stream and cool the bottoms before discharge.

The steam stripper design presented in Table 4-1 was developed using the Advanced System for Process Engineering (ASPEN).<sup>2</sup> The diameter was calculated assuming a velocity of 80 percent flooding conditions. In addition, the following engineering assumptions were made:

- Operating pressure of 1 atmosphere;
- Isothermal column operation;
- Constant molal overflow (i.e., one mole of aqueous phase vaporized for each mole of steam condensed); and

- Linear equilibrium and operating equations (i.e., Henry's Law is valid for each organic compound at the concentrations encountered in the stripping column).

The design stripper contains 10 trays. A tray efficiency of 80 percent was assumed to estimate the actual number of stages for the column. A tray spacing of 0.50 m (1.6 ft) was assumed to estimate the active column height. To approximate the total column height, a total of 2.5 m (8.2 ft) of nonactive entrance and exit column was assumed.

4.2.1.1.3 Controlling vents and openings in the steam stripper system. In a steam stripper system, vent lines carry gaseous organics, water vapor, and noncondensibles to a control device. For the stripper in Figure 4-1, vent lines are placed between the stripper column and primary condenser, between the primary condenser and feed tank, and between the feed tank and an existing onsite combustion device. A condenser system is used to recover the organic and water vapors in the gaseous overheads stream from the stripping column. The condensed overheads stream is fed to an overhead receiver, and the recovered organic compounds are either pumped to storage and recycled to the process unit or combusted for their fuel value in an incinerator, boiler, or process heater. The feed tank vent line is controlled with a combustion device or a product recovery device. A discussion of various add-on vapor stream control devices is presented in Section 4.4.

4.2.1.2 Steam Stripper Applicability and Performance. Steam stripper VOC removal efficiencies are dependent on factors affecting the degree of contact that occurs in the steam stripping column (column dimensions--height and diameter; contacting media--trays or packing; and operating parameters--steam-to-feed ratio, temperature, and wastewater pH) and wastewater characteristics such as organic compound volatility. However, in general, steam stripping is the most universally applicable VOC removal technology for treating wastewater streams such as those generated within the six industries covered by this document.

Information on the design and operation of steam stripper systems was obtained for approximately 15 steam strippers, from facility responses to 1987 Clean Air Act Section 114 information requests.<sup>3</sup> Additional information was gathered on seven steam strippers in operation at manufacturing facilities,<sup>4,5,6,7,8,9,10</sup> and five steam strippers in operation at hazardous waste transfer, storage, and disposal facilities (TSDF).<sup>11</sup> Information about steam strippers in use at pulp and paper facilities was also gathered by the Office of Air Quality Planning and Standards (OAQPS).<sup>12</sup> Although most of the steam strippers on site at pulp and paper mills were initially installed for total reduced sulfur (TRS) removal from evaporator condensate streams, as discussed in Chapter 2.0, VOC removal is also achieved. Because pulp and paper wastewater streams generally contain a high solids content, and high (evaporator condensate wastewater) and low (bleach wastewater) pH, some pretreatment or design considerations (i.e., stainless steel construction) may be warranted for steam stripping wastewater streams at pulp and paper facilities.

Data on steam strippers were also gathered by the Office of Water Regulations and Standards (OWRS) for the organic chemicals, plastics, and synthetic fibers (OCPSF); pesticide; and pharmaceutical manufacturing industries. In response to Clean Water Act Section 308 information requests, 64 OCPSF facilities reported using a total of 108 steam strippers as an in-plant control for process wastewater.<sup>13</sup> In addition to these information requests, data on steam strippers in operation at three OCPSF facilities were obtained through field testing efforts.<sup>14,15,16</sup> Information on steam strippers in use at eight pharmaceutical facilities and eight pesticide facilities was also gathered.<sup>17,18</sup>

The organic compound removal performance of five steam stripper systems was measured during field tests by collecting and analyzing samples of the feed and bottoms streams. In addition, data were gathered to evaluate the effect of design

and operating parameters on the performance of each system. These data, along with performance data provided by a facility using a recently installed steam stripper and steam stripper data obtained in response to a March 1990 Section 114 survey are presented in Table 4-2. The organic compound removals presented in Table 4-2 range from 76 percent for Site 7 to greater than 99.9 percent for Sites C, F, 321, and 131.

4.2.1.3 Steam Stripper Removal Efficiency. The removal efficiencies used in this document were predicted for the five compounds in the example wastewater stream with the steam stripper design generated using ASPEN<sup>2</sup> and presented in Table 4-1. As shown, the compounds in the medium to high volatility range were removed at efficiencies exceeding 99 percent. The results of this analysis were used to develop a relationship between removal efficiency and the Henry's Law constant for the compound. From the results of this analysis, four equations were developed for different Henry's Law constant (H) ranges, to best correlate removal efficiency (Fr) to H:

Henry's Law Constant (H) 25 °C Range (atm • m <sup>3</sup> /mol)	Fraction Removed (Fr)
H > 0.00105	Fr = 1.0
H < 3.3 x 10 <sup>-7</sup>	Fr = 0
3.3 x 10 <sup>-7</sup> ≤ H ≤ 8.9 x 10 <sup>-6</sup>	Fr = 4.168 + 0.6430 * log H
8.9 x 10 <sup>-6</sup> ≤ H ≤ 1.05 x 10 <sup>-3</sup>	Fr = 1.115 + 0.03865 * log H

Figure 4-2 presents these equations graphically. These equations are used in estimating the removal efficiencies and associated national emission reductions for the application of reasonably available control technology (RACT) to the affected industries. These calculations are presented in Appendix B.

TABLE 4-2. STEAM STRIPPER ORGANIC COMPOUND REMOVAL PERFORMANCE

Site I.D.	Organic compounds	Column design		Column operation		Column performance		
		Height (m)	Diameter (m)	Feed rate (kg/hr)	Steam:feed ratio (kg/kg) <sup>a</sup>	Feed conc. (mg/l)	Bottoms conc. (mg/l)	Organic compound removal (%)
A	Benzene, Chlorobenzene, and other Chlorinated hydrocarbons	NA	NA	48,960	0.03	5,900	9.8	>99.8
B	Chlorinated hydrocarbons	3.0 <sup>b</sup>	0.2	1,260	0.1	3,900	5.2	99.8
C	Benzene, Chlorobenzene, 1,2-, 1,3-, and 1,4-Dichlorobenzene, Ethylbenzene, Toluene, Xylene	49.0	2.5	6,624	0.14	7.98	0.305	99.96
D	1,1-Dichloroethane, 1,1-Dichloroethene, Trans-1,1-Dichloroethane, 1,1,1-Trichloroethane, Trichloroethane, Trichloroethene, 1,1,2-Trichloroethane, 1,1,2,2-Tetrachloroethane, Tetrachloroethene	NA	NA	143,556	0.14	1,984	4.9	99.75
E	Benzene, Toluene, Ethylbenzene, Isophorone, Naphthalene, 5-Ethyl-1,2-Methylpyridine, 1,2,3,4-Tetrahydronaphthalene, Acetophenone, 2-Methyl-1,3-Cyclopentanedione	26	NA	1,831	0.70	22.9	0.079	92.25
F	Chloromethane, Methylene Chloride, Chloroform, Carbon Tetrachloride, Trichloroethylene, 1,1,2-Trichloroethane	NA	1.5	2,440	0.10	5,860	0.033	>99.9
G	Nitrobenzene, Nitrotoluene	19.2	0.46	29,900	0.07	634	47.8	92
7	Benzene, Nitrobenzene, Phenol, Nitrophenols	9.8 <sup>b</sup>	0.61	5,452	0.4	1,192	250	76
10	CHC, Chlorinated Ethers, Phenol, Chlorinated Phenols	6.1 <sup>b</sup>	1.07	12,693	NA	453	3.4	99
Z	Benzene, Toluene, Chlorobenzene, Ethylbenzene, Methylene Chloride	12.2	1.22	68,100	0.20	2,073	0.04	>99.8
151	Benzene, Nitrobenzene, 2,4-Dinitrobenzene, Aniline, Nitrophenol, Phenol	11.6	1.83	8,402 <sup>c</sup>	0.625	2,317 <sup>d</sup>	23 <sup>e</sup>	99
154	Aniline, Nitrobenzene, Benzene	11.9	1.07	3,885 <sup>f</sup>	NA	3,170	31.7 <sup>e</sup>	99
163	Acrolein, Vinyl Acetate, Acetaldehyde	7.32	0.61	5,892 <sup>g,h</sup>	0.05	1,150 <sup>i</sup>	12	99
611	Methylene Chloride, Methanol, Dimethyl Ether	8.32	0.51	3,772 <sup>c</sup>	0.23	55,000 <sup>j</sup>	5,500 <sup>e</sup>	>90
921	Ethylene Dichloride	13.9	0.91	16,707 <sup>c</sup>	0.113	324 <sup>i</sup>	0.649	99.8

TABLE 4-2. STEAM STRIPPER ORGANIC COMPOUND REMOVAL PERFORMANCE (Concluded)

Site I.D.	Organic compounds	Column design		Column operation		Column performance		
		Height (m)	Diameter (m)	Feed rate (kg/hr)	Steam:feed ratio (kg/kg) <sup>a</sup>	Feed conc. (mg/l)	Bottoms conc. (mg/l)	Organic compound removal (%)
312	Monoester, n-Butanol, Dibutyl Phthalate	8.46	0.46	13,728 <sup>k</sup>	0.11	128,000	2,300	99.8
321	Benzene, Aniline, Caprolactam	14.7	0.91	9,945 <sup>c</sup>	0.12	34,300	31,205	99.9
131	n-Butanol, 4-Aminobiphenyl, Aniline	22.0	0.51	737 <sup>c</sup>	0.37	30,000	21	99.9
716	Benzene	12.2	0.41	487	0.155	280	2.8 <sup>e</sup>	99
4113	iso-Butanol	15.2	0.91	1,816 <sup>c</sup>	0.5	400,000 <sup>f</sup>	4,000	99
414	n-Butanol							
3310	Ethylmorpholine, Methylmorpholine, Morpholine	12.2	0.30	686 <sup>l</sup>	0.36 <sup>m</sup>	28,300	2,700	95 90 10

<sup>a</sup>Equal to kg of steam per l of wastewater, assuming the density of wastewater is 1 kg per l.

<sup>b</sup>Height of packed section only. Total height is not available.

<sup>c</sup>The feed flow rate was calculated by dividing the annual steam usage by the steam-to-feed ratio (SFR).

<sup>d</sup>Feed stream volatile organic concentration is the weighted average of volatile organic concentrations in several combined process wastewater streams.

<sup>e</sup>The bottoms volatile organic concentration is calculated from the following relationship:  
Bottoms concentration = Feed concentration \* (1 - stripper efficiency fraction)

<sup>f</sup>The feed flow rate was calculated from the sum of process streams into the stripper identified in the facility process flow diagram.

<sup>g</sup>Assumed wastewater feed temperature of 35 °C.

<sup>h</sup>Calculated the feed flow rate from known bottom flow rate using the following relationship:  
Feed flow rate = (Bottoms flow rate)/[0.99 (1 + SFR)]

<sup>i</sup>The feed volatile organic concentration is calculated from the following relationship:  
Feed concentration = (Bottoms concentration)/(1 - stripper efficiency fraction)

<sup>j</sup>Assumed that the two reported wastewater feed streams were of equal flow and calculated an average volatile organic concentration.

<sup>k</sup>Batch steam stripper--Assumed median flow rate of reported range.

<sup>l</sup>The flow rate was calculated from stripper bottom flow range code. The midpoint of the flow range was used for the calculation.

<sup>m</sup>The reported steam flow rate of 250 kg/hr was divided by the calculated feed flow rate of 686 kg/hr.

NA = Not available.

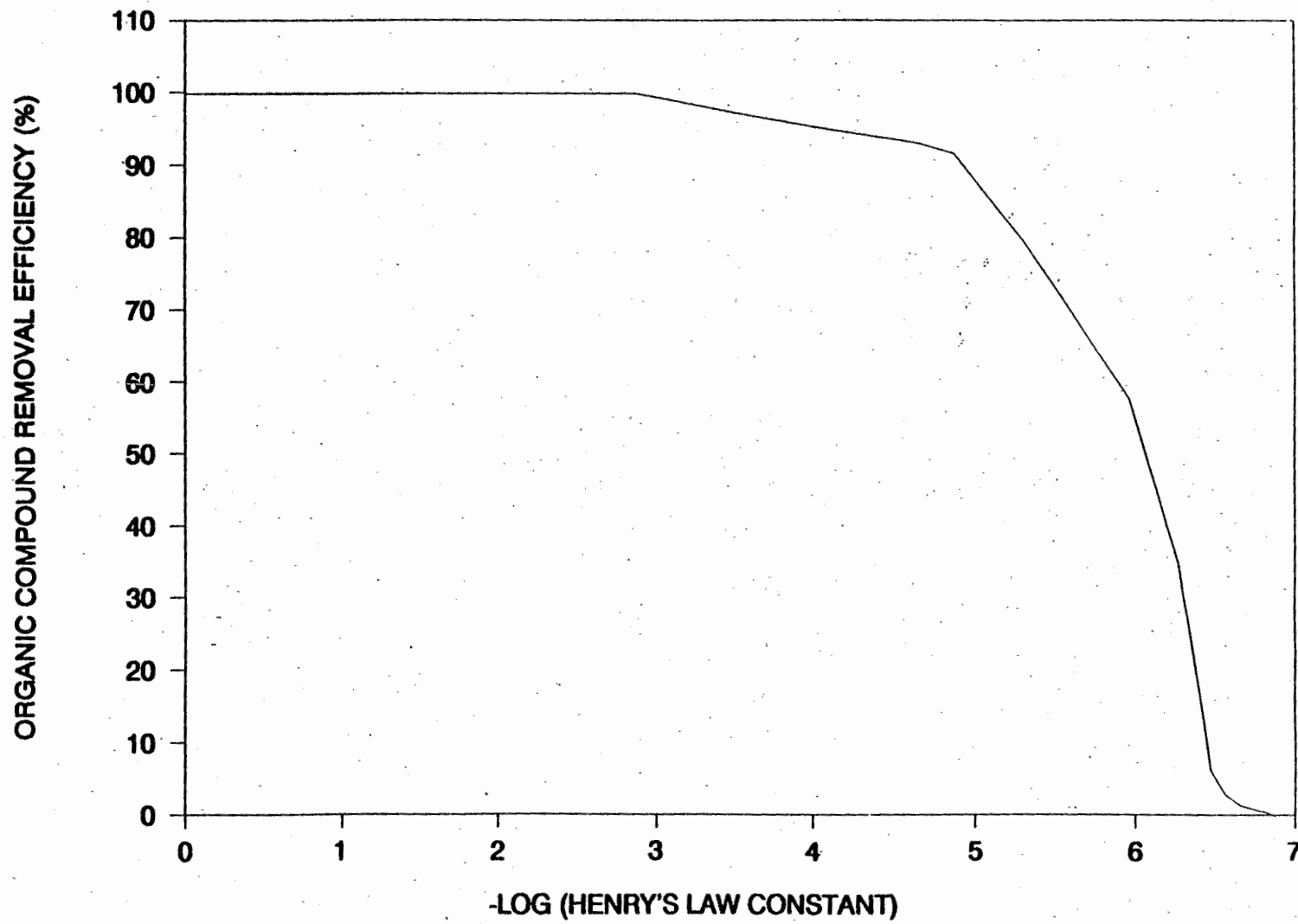

Figure 4-2. Predicted steam stripper organic compound removal efficiencies based on  $-\log$  Henry's Law constant for the compound at 25 °C.

#### 4.2.2 Air Stripping

The underlying principle for air stripping is vapor-liquid equilibrium.<sup>19</sup> By forcing large volumes of air through the contaminated water, the air-water interface is increased, resulting in an increase in the transfer rate of the organic compounds into the vapor phase. The technology is applicable to compounds with a wide range of volatilities; however, the air used to remove the organic compounds from the wastewater must be vented to a combustion or organic compound recovery device. In many cases, this add-on control device is a carbon adsorber. However, in some cases the air stream can be vented to a combustion device. In practice, air stripping is generally applicable for streams containing dilute organic compound concentrations such as pulp and paper wastewaters or contaminated ground water, and is most efficient in removal of highly volatile, water insoluble compounds.

4.2.2.1 Air Stripper Process Description. Air stripper systems can be operated in a batch or continuous mode. Because air strippers are generally used in continuous operation applications, such as ground water or drinking water remediation, continuous air strippers are more prevalent than steam strippers. Removal rates of continuous, uniform concentration wastewater streams, in general, are less variable than for batch operation.

Figure 4-3 presents a generic continuous air stripper system. The first component is the controlled sewer system or hard piping from the point of wastewater generation to the feed tank. The tank collects and conditions the wastewater feed to the air stripper. The tank is covered and vented to a control device. Wastewater is then pumped from the feed tank through a preheater and into the air stripper column. Wastewater is introduced into the top of the column while air is blown from the bottom. The wastewater stream can be heated from exhaust gas from an existing controlled boiler.

As the wastewater flows down through the column, it contacts the air that is flowing countercurrently up the column. With the increased air-water interface provided by



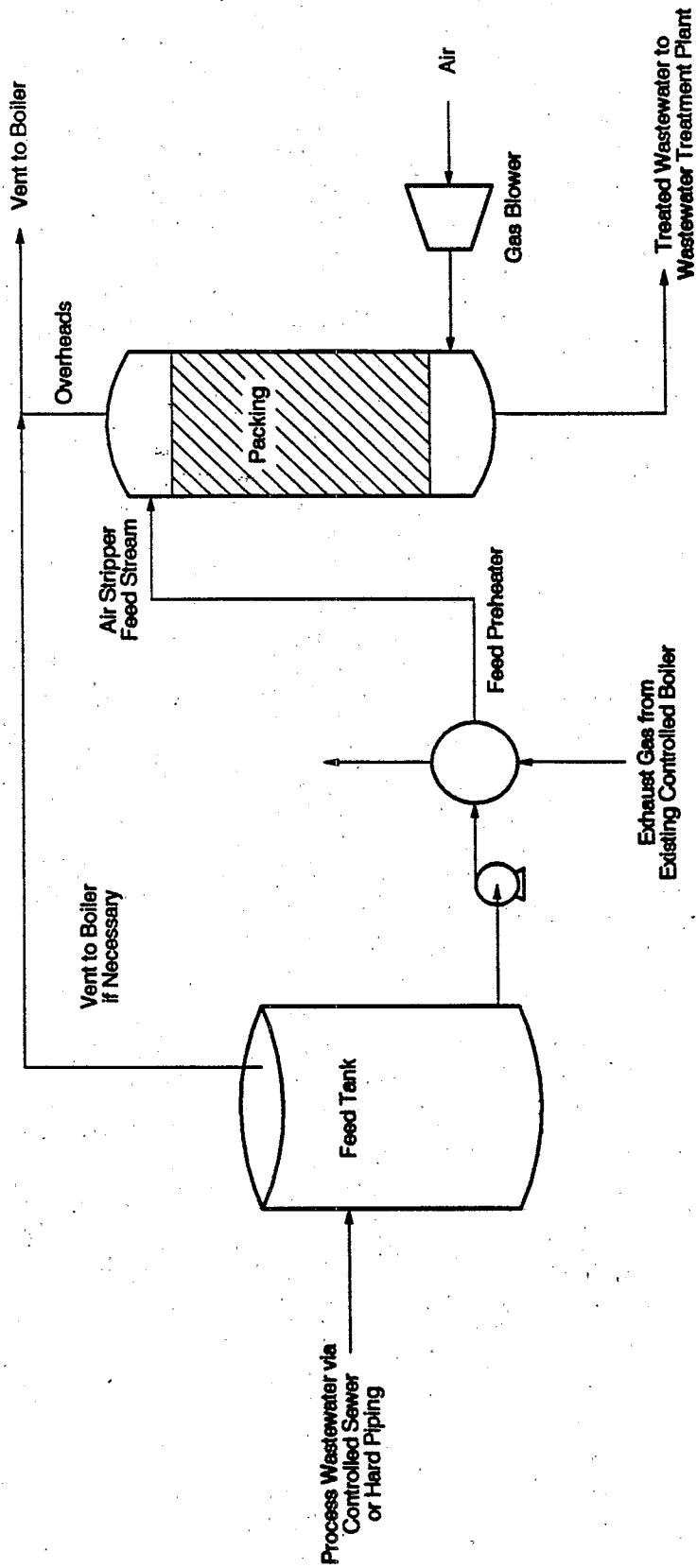

Figure 4-3. Continuous air stripper system.

3904887

packing, the rate of transfer of organic compounds to air is increased. These constituents flow out the top of the column with the air. The overheads stream can be vented to a boiler and used as combustion air with supplemental heating value. The bottoms stream typically gravity flows to an existing wastewater treatment plant.

4.2.2.2 Air Stripping Removal Performance. General information on 177 operating air strippers in the United States was gathered through a literature search.<sup>19</sup> Most of the applications were for treatment of contaminated ground water, landfill leachate, and contaminated drinking water. Data collected for 46 of the 177 air strippers demonstrate average percent removal ranges for the following selected compounds:

- Benzene = 99 to 99.9;
- Toluene = 96 to 99+;
- Xylene = 96 to 99.8;
- Trichloroethylene = 90 to 99.9;
- Methyl-tert-butyl ether = 95 to 99;
- 2-Methyl phenol = 70 (one point);
- Phenol = 74 (one point); and
- Aniline = 58 (one point).

#### 4.2.3 Biological Organic Compound Destruction Technology

Biological waste treatment is normally accomplished through the use of aeration basins. Microorganisms require oxygen to carry out the biodegradation of organic compounds that results in energy and biomass production. The aerobic environment in the basin is normally achieved by the use of diffused or mechanical aeration. This aeration also serves to keep the biomass well mixed. The goal is to maintain the biomass concentration at a level where the treatment is efficiently optimized and proper growth kinetics are induced.

The performance of aeration basins is particularly affected by: (1) mass of organic per unit area; (2) temperature and wind patterns; (3) hydraulic retention time; (4) dispersion and mixing characteristics; (5) sunlight energy; (6) characteristics of the solids in the influent; and

(7) the amount of essential microbial nutrients present. Basin efficiency, measured as the degree of stabilization of the incoming wastewater, is dependent on both biological process kinetics and basin hydraulic characteristics.

Three mechanisms affect the removal of organic compounds in aeration basins. These mechanisms are biodegradation, adsorption onto the sludge, and air emissions. Because these three mechanisms compete against each other, factors affecting biodegradation and adsorption mechanisms will have an effect on air emissions.<sup>20</sup> The greater the biomass concentration in the basin, the greater the removal of organic compounds will be by both biodegradation and adsorption mechanisms. The biodegradability of a compound will also affect its removal by biodegradation; as the biodegradability of the compound increases, so does the rate of biodegradation. Also, because the microorganisms prefer some compounds more than others, the biodegradation process is selective and depends on the compound matrix. Octanol-water partition coefficients are often used to indicate the affinity of a compound for the organic or aqueous phase. The relative magnitude of this coefficient provides some indication of organic compound removal by the adsorption mechanism.

Typically, aeration basins are equipped with aerators to introduce oxygen into the wastewater. The biomass uses this oxygen in the process of biodegrading the organic compounds. However, aeration of wastewater also affects air emissions. Because of the turbulence caused by the aerators, an increased liquid surface area is exposed to ambient air; therefore, the liquid and gas phase resistances to mass transfer are reduced. Convective mass transfer in both phases is increased. This transfer mechanism significantly increases air emissions compared to quiescent, flow-through type tanks such as clarifiers. However, many of the factors that affect emissions from flow-through tanks also affect emissions from aeration basins. The concentration and physical properties of the organic compounds have a similar effect on emissions. As the volatility and diffusivities in water and air of the

organic constituents increase, air emissions also tend to increase.

Other factors affecting emissions from aeration basins include wind speed and basin design characteristics. Increases in wind speed increase convective mass transfer from the wastewater in the basin and, therefore, increase air emissions. However, emissions from aeration basins are not as sensitive to wind speed effects as those from quiescent basins. Basin design characteristics that affect emissions include: the quiescent and turbulent surface areas, the depth of the basin, the design of the aerators, and the hydraulic retention time of the basin. As the turbulent surface area of the basin increases, air emissions will also tend to increase as a result of increased convective mass transfer of the organic compounds. The depth of the basin affects mass transfer in the liquid phase. Convective mass transfer in the liquid phase increases as the basin becomes more shallow, and, therefore, air emissions also tend to increase. Because the aerators generate the turbulence that increases the rate of mass transfer in the liquid and gas phases, the design of these aerators has a significant effect on emissions. The degree of turbulence these aerators impart to the wastewater is a function of the power output to the impellers, the impeller speed, and the impeller diameter. Increases in these design parameters result in additional turbulence of the wastewater, which tends to increase air emissions. The final design parameter affecting emissions is the volume of the basin. As the volume increases, so does the hydraulic retention time. Increases in the basin volume provide additional time for removal by all three mechanisms: biodegradation, adsorption, and air emissions. Therefore, the magnitude of the increase in air emissions due to the additional retention time depends on the relative removal rates by the other two mechanisms. Biological treatment basin emission factors can be estimated using CHEM.7.<sup>21</sup> Site specific biological degradation rate constants for use in

developing these factors can be calculated using the biorate protocol (under development).

#### 4.2.4 Other Organic Compound Removal Technologies

This section presents other control technologies for reducing VOC emissions from industrial wastewaters. These technologies reduce VOC emissions by removing organic compounds from the wastewater before they are emitted to the air. Although steam stripping and air stripping are the most widely applicable technologies for VOC emission reduction from industrial wastewaters, there are applications where other technologies may be more appropriate. The purpose of this section is to present some of these technologies along with a brief discussion of each.

In addition to steam stripping, technologies available for removing organic compounds from wastewater include chemical oxidation, carbon and ion exchange adsorption, membrane separation,<sup>22</sup> and liquid-liquid extraction. These technologies rely on a variety of mechanisms to remove organic compounds from wastewater. These technologies are used in different applications by facilities in the targeted industries and may be effective at removing certain organic compounds. For this reason, a brief description of each technology is provided below.

Chemical oxidation involves a chemical reaction between the organic compounds and an oxidant such as ozone, hydrogen peroxide, permanganate, or chlorine dioxide. The applicability of this technology depends on the reactivity of the individual organic compounds. For example, phenols and aldehydes are more reactive than alcohols and alkyl-substituted aromatics; halogenated hydrocarbons and saturated aliphatic compounds are the least reactive.<sup>23</sup>

Adsorption processes take advantage of compound affinities for a solid sorbent medium. Activated carbon or polymeric resins are often used as the medium. The volatile compounds are adsorbed onto the solid sorbent medium as they are contacted by the wastewater. Nonpolar compounds can be adsorbed onto the surface of activated carbon. By contrast,

removal by polymeric resins involves both adsorption and ion exchange mechanisms and is therefore more effective for polar compounds. With carbon adsorption, the capacity of the carbon to adsorb the organic compounds at a given influent concentration varies widely for different compounds. In addition, the ease of desorption (removal) of the organic compounds and possible wastewater contaminants from the carbon is highly variable. For these reasons, the feasibility of using carbon adsorption must be evaluated on a case-by-case basis. A more detailed evaluation of the applicability of carbon adsorption to organic compound removal from industrial wastewaters is documented in a memorandum entitled "Evaluation of Carbon Adsorption as a Control Technology for Reducing Volatile Organic Compounds (VOC) from Industrial Wastewaters."<sup>24</sup>

Two types of membrane separation processes are ultrafiltration and reverse osmosis. Ultrafiltration is primarily a physical sieving process driven by a pressure gradient across a membrane. This process separates macromolecular organic compounds with molecular weights of greater than 2,000, depending on the membrane pore size. Reverse osmosis is the process by which a solvent is forced across a semipermeable membrane due to an osmotic pressure gradient. Selectivity is, therefore, based on osmotic diffusion properties of the compound and the sizes of the compound and the membrane pores.<sup>22</sup>

Liquid-liquid extraction, sometimes referred to as solvent extraction, uses differences in solubility of compounds in various solvents as a separation technique. By contacting a solution containing the desired compound with a solvent in which the compound has a greater solubility, the compound may be removed from the solution. This technology is often used for product and process solvent recovery for two reasons. First, the solvent can usually be regenerated, and second, the compound of interest can often be recovered by distillation.

#### 4.3 VOLATILE ORGANIC COMPOUND EMISSION SUPPRESSION FROM COLLECTION AND TREATMENT SYSTEM COMPONENTS

The VOC emissions from wastewater collection and treatment systems can be controlled either by hard piping or by enclosing the transport and handling system from the point of wastewater generation until the wastewater is treated to remove or destroy the organic compounds. Suppression techniques can be broken down into four categories: collection system controls, roofs, floating membranes, and air-supported structures. These devices and their associated VOC suppression efficiencies are discussed in detail in the Wastewater CTC Document.<sup>1</sup> Suppression of VOC emissions merely keeps the organic compounds in the wastewater until they reach the next potential VOC emission source. Therefore, these techniques are not effective unless the VOC emissions are suppressed until the wastewater reaches a treatment device where the organic compounds are either removed or destroyed.

##### 4.3.1 Collection System Controls

As discussed in Chapter 3.0, collection systems comprise components such as drains, junction boxes, sumps, trenches, and lift stations that provide contact between wastewater and ambient air. These collection system components provide escape routes for organic compounds contained in wastewater. Suppression controls can be applied to most of these components to reduce the potential of VOC emissions during wastewater collection. These controls involve the use of physical covers and water seals to minimize the contact between ambient air and the wastewater flowing through the component. Physical covers and water seals are only effective if the wastewater flows downstream and to an organic compound removal or destruction device, such as a steam stripper or biological treatment basin. The applicable VOC suppression controls for each of the wastewater collection system components are presented in the following sections. A complete description of each suppression control device can be found in the Wastewater CTC Document.<sup>1</sup> The collection system

VOC suppression devices discussed are consistent with the "Benzene Waste Operations National Emission Standards for Hazardous Air Pollutants (NESHAP) 40 CFR Part 61 Subpart FF."

Two commonly used methods for controlling emissions from drains are leg and seal pot configurations. Use of p-leg seals and seal pots can reduce VOC emissions from drains if the system is well maintained; however, monitoring the performance of the control will be difficult. Control of emissions can also be achieved by hard piping any source of wastewater containing organic compounds to a control device. Other collection system components that typically require control are junction boxes, sumps, and lift stations. Since the design of these three components are similar, the same technique is effective for suppressing VOC emissions from all three. For these components, a gas tight cover is typically used.

#### 4.3.2 Roofs

The following discussion on fixed- and floating roof tank covers is consistent with the "New Source Performance Standards (NSPS) for Petroleum Refinery Wastewater Systems Final Rule," promulgated in November 1988.<sup>25</sup>

4.3.2.1 Fixed-Roof Tanks.<sup>26</sup> Storage or treatment of wastewater in fixed-roof tanks instead of open-top tanks reduces VOC emissions. By covering the tank, the wastewater surface is sheltered from the wind. This decreases the mass transfer rate of organic compounds in the wastewater to the atmosphere. The extent to which VOC emissions are reduced depends on many factors including wastewater composition and organic compound concentrations, windspeed, and the ratio of the tank diameter to the depth of the wastewater contained in the tank.

Although fixed-roof tanks provide large reductions in VOC emissions compared to open-top tanks, fixed-roof tanks can still emit significant quantities of VOC. The major sources of VOC emissions from fixed-roof tanks are breathing losses and working losses. Breathing losses occur from the expulsion of vapor through the roof vents because of the expansion or



contraction of the tank vapor space resulting from daily changes in ambient temperature or barometric pressure. These VOC emissions occur in the absence of any liquid level change in the tank. Working losses occur from the displacement of vapors resulting from filling and emptying the tank. Breathing and working losses from fixed-roof tanks can be reduced by installing an internal floating roof, connecting the tank roof vents to an add-on control device, or installing pressure-vacuum relief valves on the tank roof vents.

4.3.2.2 Floating Roof Tanks.<sup>27</sup> Floating roofs are used extensively in the petroleum refining, gasoline marketing, and chemical manufacturing industries to control VOC emissions from tanks storing organic liquids.

There are two general types of floating roof tanks: those with external floating roofs and those with internal floating roofs. Floating roofs are appropriate for wastewater storage tanks and certain treatment tanks where the presence of the floating cover would not interfere with the treatment process. Treatment tanks equipped with surface mixing or aeration equipment cannot use floating roofs. Also, because floating roofs are in direct contact with the wastewater, the materials selected to fabricate the deck and seals must be compatible with the wastewater composition.

Floating roof tanks significantly reduce but do not eliminate VOC emissions. Organic vapor losses called "standing losses" occur at the deck seals and fitting openings. Additional organic vapor losses called "withdrawal losses" occur from evaporation of the liquid that wets the inside tank wall as the roof descends during emptying operations.

4.3.2.3 Oil/Water Separators. The most effective option for controlling VOC emissions from oil/water separators is to install either a fixed or floating roof. These roofs control VOC emissions by reducing the oil surface exposed to the atmosphere, reducing the effects of wind velocity, and reducing the effects of solar radiation by insulating the oil layer.

Fixed roofs can be installed on most oil/water separators. This can be done without interfering with the operation of the system by mounting on the sides of the separator or by supporting with horizontal steel beams set into the sides of the unit. Gas-tight access doors are usually installed in the roof for maintenance and inspection. Since the vapor space below fixed roofs may constitute an explosion or fire hazard, the vapor space is often blanketed with nitrogen and/or purged to a recovery or destruction device.

For floating roofs, the effectiveness of their emission control is primarily dependent on the effectiveness of the seals between the roofs and walls of the separator. If these seals are not well maintained to prevent leakage, their VOC emission control capabilities will be reduced significantly.

One final concern in evaluating emissions from oil/water separators is the handling of the recovered oils. Since the oils may contain high concentrations of organic compounds, care must be taken to minimize VOC emissions. This can be accomplished by handling the oils and organic compounds in closed systems equipped with emission controls.

#### 4.3.3 Floating Membrane Covers<sup>28</sup>

A floating membrane cover consists of large sheets of synthetic flexible membrane material that floats on the surface of the wastewater. Individual sheets can be seamed or welded together to form covers applicable to any size area. Floating membrane covers have been used successfully for many years to cover the surface of potable water impoundments or reservoirs. In a "leak tight" application, floating membrane covers have been used to cover large anaerobic digester lagoons to collect the methane gas for energy recovery. Thus, floating membrane covers offer good potential as a suppression device for wastewater surface impoundments.

The effectiveness of a floating membrane cover depends on the amount of wastewater surface that is covered and the permeability of the membrane material to the organic compounds contained in the wastewater. Using a membrane material with

adequate thickness and following good installation practices will minimize tearing or puncturing of the membrane material. The overall cover permeability is a function of the organic composition and concentration of the wastewater managed in the surface impoundment as well as the cover material's composition and thickness. The EPA has developed a laboratory protocol to measure the permeability of volatile organics (VO's) through flexible membrane covers.<sup>29</sup>

#### 4.3.4 Air-Supported Structures<sup>30</sup>

An air-supported structure is a plastic-reinforced fabric shell that is inflated and therefore requires no internal rigid supports. The structure, shape, and support are provided by maintaining a positive interior pressure (i.e., the interior pressure is greater than the external atmospheric pressure). Adequate air changes are necessary to prevent the organic vapor concentrations inside the structure from exceeding the lower explosive limits. The vent system can discharge directly to the atmosphere or be connected to an add-on control device.

Because of the low leakage levels attainable, almost all of the organic vapors contained by an air-supported structure will be ultimately discharged through the structure's vent system. Therefore, connecting the vent system to one of the add-on control devices discussed in Section 4.4 will result in an overall VOC emission control efficiency for wastewater treatment applications using an air-supported structure that is approximately equivalent to the efficiency of the control device. These add-on control devices are capable of achieving control efficiencies in excess of 95 percent.

Large areas can be enclosed by erecting an air-supported structure. Structures are commercially available ranging in widths from 24 to 91 m (80 to 300 ft) wide and lengths from 24 to 137 m (80 to 450 ft). For larger areas, a number of modules can be connected together. Air-supported structures have been used as enclosures for conveyors and coke ovens, open-top tanks, material storage piles, biological treatment basins, and landfills.

#### 4.4 ADD-ON CONTROLS

Add-on controls serve to reduce VOC emissions by destroying or extracting organic compounds from gas phase vent streams before they are discharged to the atmosphere. Add-on controls are applicable to vents associated with collection and treatment covers, such as drain covers, fixed roofs, and air-supported structures, and with organic compound removal devices, such as air strippers and steam strippers. Add-on controls for VOC emissions are classified into four broad categories: adsorption, combustion, condensation, and absorption. General background information about these types of add-on controls is available in the Wastewater CTC Document.<sup>1</sup> The type of add-on control best suited for a particular wastewater emission source depends on the size of the source and the characteristics of the wastewater in the source.

Combustion destroys the organic compounds in the gas stream by oxidation of the compounds primarily to carbon dioxide and water. Because essentially all organic compounds will burn, combustion add-on controls are applicable to all emission sources for which the organic vapors can be captured. Combustion add-on controls are thermal vapor incinerators, catalytic vapor incinerators, flares, boilers, and process heaters.

##### 4.4.1 Carbon Adsorbers<sup>31</sup>

Adsorption as applied to air pollution control is the process by which organic molecules in a gas stream are retained on the surface of solid particles. The solid most frequently used is carbon that has been processed or "activated" to have a porous structure. Such carbon provides many surfaces upon which the organic molecules can attach, resulting in a high rate of organic compound removal from a gas stream as it passes through a bed of carbon.

Activated carbon has a finite adsorption capacity. When the carbon becomes saturated (i.e., all of the carbon surface is covered with organic material), there is no further VOC

emission control because all of the organic vapors pass through the carbon bed. At this point (referred to as "breakthrough"), the organic compounds must be removed from the carbon before VOC emission control can resume. This process is called desorption or regeneration.

For most air pollution control applications, regeneration of the carbon in the adsorber is performed by passing steam through the carbon bed. The steam heats the carbon particles, which releases the organic molecules into the steam flow. The resulting steam and organic vapor mixture is condensed to recover the organic compounds and separate the water for discharge to a wastewater treatment unit. Alternative methods for regenerating the carbon are to use hot air to desorb the organics from the carbon or to reduce the pressure of the atmosphere surrounding the carbon particles. Vacuum regeneration is generally used for special carbon adsorber applications when direct recycling of the recovered organic compounds is desired, such as in vapor recovery at gasoline tank truck loading terminals.

Two types of carbon adsorption systems most commonly used for VOC emission control are fixed-bed carbon adsorbers and carbon canisters. A fluidized-bed carbon adsorption system has been developed but currently is not commercially available.

Fixed-bed carbon adsorbers are used for controlling continuous, organic gas streams with flow rates ranging from 30 to over 3,000 cubic meters per minute ( $m^3/min$ ) (1,000 to over 100,000 cubic feet per minute [ $ft^3/min$ ]). The organic compound concentration can be as low as several parts per billion by volume (ppbv) or as high as 25 percent of the lower explosive limit of the vapor stream constituents. The major components of a fixed-bed carbon adsorber system are one or more carbon bed units to adsorb the organic compounds, a condenser to convert the desorbed organics and a steam mixture to a liquid, a decanter to separate the organic and aqueous phases, and blowers to cool and dry the carbon beds following desorption.

Fixed-bed carbon adsorbers may be operated in either intermittent or continuous modes. For intermittent operation, the adsorber removes organic compounds only during a specific period of the day. Intermittent mode of operation allows a single carbon bed to be used because it can be regenerated during the off-line periods. For continuous operation, the unit is equipped with two or more carbon beds so that at least one bed is always available for adsorption while other beds are being regenerated.

Carbon canisters differ from fixed-bed carbon adsorbers. First, a carbon canister is a very simple add-on control device consisting of a 0.21 m<sup>3</sup> (7.4 ft<sup>3</sup>) drum with inlet and outlet pipe fittings. A typical canister unit is filled with 70 to 90 kilograms (kg) (150 to 3,200 pounds [lb]) of activated carbon. Second, use of carbon canisters is limited to controlling low volume gas streams with flow rates less than 3 m<sup>3</sup>/min (100 ft<sup>3</sup>/min). Third, the carbon cannot be regenerated directly in the canister. Once the activated carbon in the canister becomes saturated by the organic vapors, the carbon canister must be removed and replaced with a fresh carbon canister. The spent carbon canister is then recycled or discarded depending on site-specific factors.

A well designed and operated carbon adsorption system applied to an organic compound containing vent stream is generally capable of achieving removal efficiencies in excess of 95 percent. Additional details regarding carbon adsorption system design and performance are discussed in the Wastewater CTC Document.<sup>1</sup>

#### 4.4.2 Thermal Vapor Incinerators<sup>32</sup>

Thermal vapor incineration is a controlled oxidation process that occurs in an enclosed chamber. One type of thermal vapor incinerator consists of a refractory-lined chamber containing one or more discrete burners that premix the organic vapor gas stream with the combustion air and any required supplemental fuel. A second type of incinerator uses a plate-type burner firing natural gas to produce a flame zone

through which the organic vapor gas stream passes. Packaged thermal vapor incinerators are commercially available in sizes capable of handling gas stream flow rates ranging from approximately 8 to 1,400 m<sup>3</sup>/min (300 to 47,000 ft<sup>3</sup>/min).<sup>32</sup> Properly designed and operated thermal vapor incinerators are generally capable of achieving organic compound destruction efficiencies in excess of 98 percent. Additional information on design and performance of thermal vapor incineration systems is presented in the Wastewater CTC Document.<sup>1</sup>

#### 4.4.3 Combination Adsorption--Incineration<sup>33</sup>

The technologies of carbon adsorption and thermal vapor incineration can be combined into a single control technology. Figure 4-4 shows a simplified diagram of such a system, consisting of two fixed bed carbon adsorbers and an incineration unit. Carbon bed 1 operates in the adsorption mode, removing organic compounds from the vent stream, while carbon bed 2 is regenerated. Regeneration is performed by passing a portion of the hot incinerator flue gas through the carbon bed. This regeneration gas is first cooled to approximately -4 to 180 °C (25 to 350 °F), depending on the physical and chemical characteristics of the organic compounds absorbed into the carbon. The regeneration gas then passes through the carbon bed, quickly raising its temperature and causing the organic compounds to desorb. The resulting concentrated vent stream is routed to the incinerator where the organic compounds are thermally oxidized. The flue gas exiting the incinerator may be routed through a scrubber for those facilities that have chlorinated organics.

Because the organic compounds are delivered to the incinerator in a more concentrated stream than the dilute vent stream, auxiliary fuel requirements for the incinerator are reduced. Additionally, there is no need for solvent recovery, which is an advantage in those situations where recovery is not desirable or economically feasible. This system can be operated on a continuous or intermittent basis. On an

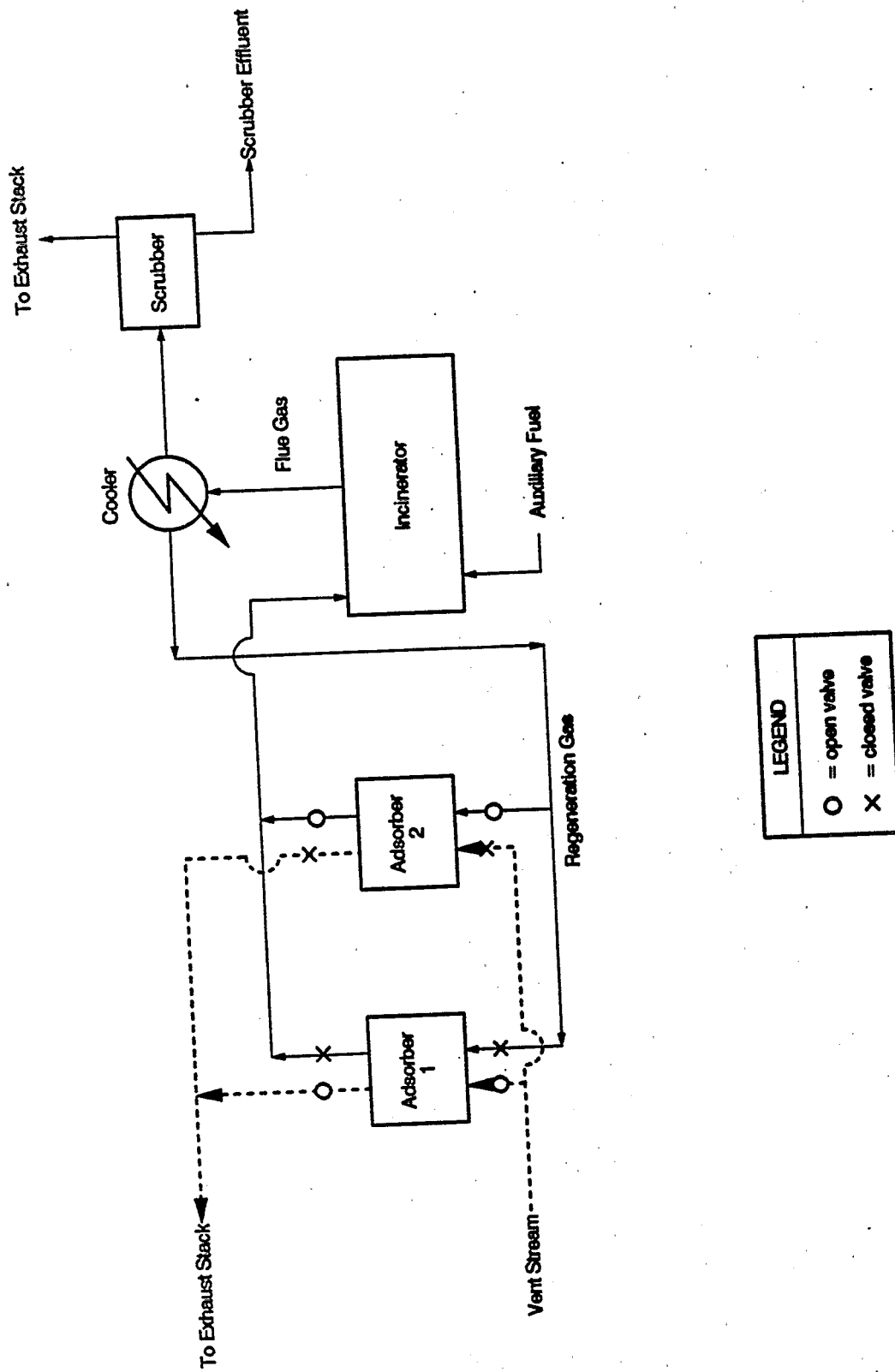

Figure 4-4. Combination carbon adsorption - thermal incineration system.



intermittent basis, an auxiliary fuel such as natural gas is used to bring the incinerator up to operating temperature.

Packaged units are available from approximately 30 to 1,400 m<sup>3</sup>/min (1,000 to 47,000 ft<sup>3</sup>/min) with organic compound destruction efficiencies of 95 to 99 percent. Custom designed units are available to handle requirements in excess of 1,400 m<sup>3</sup>/min (47,000 ft<sup>3</sup>/min).<sup>33</sup> Organic compound removal/destruction efficiencies are similar to those for standard vapor phase carbon adsorption systems.

#### 4.4.4 Catalytic Vapor Incinerators<sup>34</sup>

Catalytic vapor incineration is essentially a flameless combustion process. Passing the organic vapor stream through a catalyst bed promotes oxidation of the organic compounds at temperatures in the range of 320 to 650 °C (600 to 1,200 °F). Temperatures below this range slow down or stop the oxidation reactions, which results in low destruction efficiencies. Temperatures above this range shorten catalyst life or may even cause catalyst failure. Oxidation of vapor streams with a high organic compound content can produce temperatures well above 650 °C (1,200 °F). Consequently, vapor streams with high organic compound concentrations may not be suitable for catalytic incineration. In a typical catalytic incinerator, the gas stream vented from the emission source is heated in a combustion chamber to the desired reaction temperature by mixing the organic vapors with hot combustion gas from natural gas-fired burners. The heated gas mixture then contacts the catalyst bed and is oxidized. The catalyst is composed of a porous inert substrate material that is plated with a metal alloy containing platinum, palladium, copper, chromium, or cobalt. A well designed and operated catalytic vapor incinerator generally destroys 97 to 98 percent of the organics and hazardous air pollutants (HAP's).<sup>34</sup> Other design and performance of catalytic vapor incinerators are discussed in the Wastewater CTC Document.<sup>1</sup> A heat exchanger is typically installed to preheat the inlet vapor stream by indirect heat transfer from the hot flue gasses, thus reducing

the amount of fuel that must be burned to maintain the operating temperature.

#### 4.4.5 Flares<sup>35</sup>

Unlike vapor incinerators, a flare is an open combustion process. The ambient air surrounding the flare provides the oxygen needed for combustion. Consequently, a flare does not require blowers to provide combustion air. To achieve smokeless flare operation, turbulent mixing of the organic vapor stream with the ambient air at the flame zone boundary can be "assisted" by injecting steam or air at the flare tip or by releasing the gas stream through a high-velocity nozzle (i.e., a nozzle with a high pressure drop). Flares are used extensively to burn purge and waste gases from many industrial processes such as petroleum refinery process units, blast furnaces, and coke ovens. A study by the EPA concluded that 98 percent combustion efficiency can be achieved by steam-assisted and air-assisted flares burning gases with heat contents greater than 11 megajoules (MJ) per m<sup>3</sup> (300 British thermal units [Btu] per ft<sup>3</sup>).<sup>35</sup> Design and performance of flares are discussed in detail in the Wastewater CTC Document.<sup>1</sup>

#### 4.4.6 Boilers and Process Heaters<sup>36</sup>

A boiler or process heater can be used for organic vapor destruction. The organic vapor stream is either:

- (1) premixed with a gaseous fuel and fired using the existing burner configuration, or
- (2) fired separately through a retrofit special burner or burners to the combustion unit.

Industrial boilers and process heaters are currently being used to burn vent gases from chemical manufacturing, petroleum refining, and pulp and paper manufacturing process units. A study investigating the destruction efficiency of five process heaters firing a benzene vapor and natural gas mixture showed 98 to 99 percent overall destruction efficiencies for C<sub>1</sub> to C<sub>6</sub> hydrocarbons. Design and performance of boilers and process heaters are discussed in the Wastewater CTC Document.<sup>1</sup>

#### 4.4.7 Condensers<sup>37</sup>

Condensation is the process by which a gas or vapor is converted to a liquid form by lowering the temperature or increasing the pressure. This process occurs when the partial pressure for a specific organic compound in the vapor stream equals its partial pressure as a pure substance at operating conditions. For air pollutant control applications, cooling the gas stream is the more cost-effective method of achieving organic compound condensation.

There are two major types of condensers: surface condensers and contact condensers. In a surface condenser the coolant does not contact the vapors or the condensate. In a contact condenser the coolant and vapor stream are physically mixed together inside the vessel and exit the condenser as a single stream.

A field evaluation of a condenser used to recover organics from a steam stripping process used to treat wastewater at a plant manufacturing ethylene dichloride and vinyl chloride monomer was conducted. The measured condenser removal efficiencies for specific organic constituents ranged from a high value of 99.5 percent for 1,2-dichloroethane to a low value of 6 percent for vinyl chloride. Additional design and performance of condensers are discussed in the Wastewater CTC Document.<sup>1</sup>

#### 4.5 REFERENCES

1. Office of Air Quality Planning and Standards, U. S. Environmental Protection Agency. Research Triangle Park, North Carolina. Industrial Wastewater Volatile Organic Compound Emissions--Background Information for BACT/LAER Determinations. EPA-450/3-90-004. January 1990.
2. U. S. Environmental Protection Agency. ASPEN Expert System for Steam Stripping Calculations. EPA-450/3-90-003. July 1990.
3. Letter and attachments from Radian Corporation to P.E. Lassiter, EPA/OAQPS, July 27, 1987, on the summary of data provided in confidential Section 114 questionnaire responses.
4. Trip Report. Howle, R. H., and M. A. Vancil, Radian Corporation, to file. 7 p. Report of May 12, 1987, visit to Allied Fibers.
5. Trip Report. Herndon, D. J., and S. K. Buchanan, Radian Corporation, to file. 10 p. Report of May 22, 1987, visit to Rhone-Poulenc Agricultural (RP Ag) Company.
6. Trip Report. Herndon, D. J., Radian Corporation, to file. 5 p. Report of May 6, 1987, visit to PPG Industries.
7. Trip Report. Herndon, D. J., and S. K. Buchanan, Radian Corporation, to file. 7 p. Report of May 21, 1987, visit to Mobay Chemical Company.
8. Trip Report. Herndon, D. J., Radian Corporation, to file. 11 p. Report of May 4, 1987, visit to Borden Chemical Company.
9. Trip Report. Herndon, D. J., Radian Corporation, to file. 4 p. Report of May 5, 1987, visit to Union Carbide Corporation.
10. Trip Report. Herndon, D. J., Radian Corporation, to file. 13 p. Report of May 8, 1987, visit to Dow Chemical Company.
11. U. S. Environmental Protection Agency. Hazardous Waste Treatment, Storage, and Disposal Facilities (TSDF)--Background Information for Proposed RCRA Air Emission Standards. Volume 2. Appendices D-F. EPA/450/3-89/023B. June 1991. pp. F-148 to F-163.
12. Trip Report. Elliott, J. A., and S. L. Watkins, Radian Corporation, to file. 8 p. Report of September 25, 1989, visit to Union Camp Corporation.

13. Memorandum from Herndon, D. J., Radian Corporation, to Industrial Wastewater file. Summary of Facilities Reporting Use of Steam Stripping. May 20, 1988.
14. Environmental Science & Engineering, Inc., and SAIC. Plant No. 4--Organic Chemicals Best Available Technology Long-Term Field Sampling. Prepared for U. S. Environmental Protection Agency, Office of Water Regulations and Standards. July 1985.
15. Reference 13, Plant No. 7.
16. Reference 13, Plant No. 15.
17. U. S. Environmental Protection Agency. Development Document for Effluent Limitations Guidelines for the Pesticide Point Source Category. EPA-440/1-85/079. October 1985. pp. VI-60 to VI-62.
18. U. S. Environmental Protection Agency. Development Document for Final Effluent Limitations Guidelines, New Source Performance Standards and Pretreatment Standards for the Pharmaceutical Manufacturing Point Source Category. EPA-440/1-83-084. September 1983.
19. U. S. Environmental Protection Agency, Office of Air Quality Planning and Standards. Air Stripping of Contaminated Water Sources--Air Emissions and Control. EPA-450/3-87-017 (NTIS PB88-106166). Research Triangle Park, North Carolina. August 1987.
20. U. S. Environmental Protection Agency. Office of Air Quality Planning and Standards. Hazardous Waste Treatment, Storage, and Disposal Facilities (TSDF)--Air Emission Models. Draft Report. EPA-450/3-87-026. November 1989.
21. U. S. Environmental Protection Agency. Chemical and Petroleum Branch, Office of Air Quality Planning and Standards. User's Guide for CHEMDATA Compound Property Processor (CHEM7). Research Triangle Park, NC. December 1989.
22. Weber, Walter J. and Edward H. Smith. Removing Dissolved Organic Contaminants from Water. Environmental Science Technology. Vol. 20, No. 10. October 1986. pp. 970 to 979.
23. Cheremisinoff, Paul N. Haz Waste Treatment and Recovery Systems. Pollution Engineering. Vol. XX, No. 2, pp. 52 to 61. February 1988.
24. Memorandum from Elliott, J. A., Radian Corporation, to Industrial Wastewater file. Evaluation of Carbon Adsorption as a Control Technology for Reducing Volatile

Organic Compounds (VOC) from Industrial Wastewaters.  
November 30, 1988.

25. Federal Register, Volume 53, No. 226. pp. 47616 to 47629. 40 CFR, Part 60, November 23, 1988.
26. U. S. Environmental Protection Agency. Hazardous Waste Treatment, Storage, and Disposal Facilities (TSDF)-- Background Information for Proposed RCRA Air Emission Standards. Volume 1. Chapters 1-8 and Appendices A-C. EPA-450/3-89-023a. June 1991. pp. 4-5 to 4-9.
27. Reference 26, pp. 4-9 to 4-11.
28. Reference 26, pp. 4-12 to 4-15.
29. U. S. Environmental Protection Agency. Method Development for Flexible Membrane Permeability Testing for Hazardous Waste Treatment, Storage, and Disposal Facilities. Final Report. September 1990. Contract No. 68-D9-0055.
30. Reference 26, pp. 4-15 to 4-19.
31. Reference 26, pp. 4-22 to 4-27.
32. Reference 26, pp. 4-28 to 4-30.
33. Letter and attachments from Calgon Corporation to R. H. Howle, Radian Corporation, January 29, 1990, on CADRE™.
34. Reference 26, pp. 4-30 to 4-33.
35. Reference 26, pp. 4-33 to 4-36.
36. Reference 26, p. 4-36.
37. Reference 26, pp. 4-36 to 4-39.

## 5.0 CONTROL COST, ENVIRONMENTAL, AND ENERGY IMPACT ANALYSES OF TREATMENT BY STEAM STRIPPING

This chapter presents the control cost, environmental, and energy impacts of the treatment of wastewater by steam stripping. Steam strippers were discussed in Chapter 4.0 as an effective emission control strategy for removal of organic compounds from industrial wastewater. In Section 5.1, steam stripper capital costs and annualized costs are presented for an example wastewater stream. Section 5.2 presents environmental and energy impacts for the same example wastewater stream. The impacts presented are for the steam stripper system design presented in Chapter 4.0 (see Figure 4-1).

### 5.1 STEAM STRIPPER SYSTEM COSTS

#### 5.1.1 Basis For Capital Costs

The total capital investment (TCI) for a steam stripper system includes the purchased equipment costs (PEC), direct installation costs, and indirect installation costs. The PEC comprises the basic equipment cost (BEC), auxiliary piping and equipment costs, instrumentation costs, freight charges, and sales tax. The BEC is estimated using published engineering cost estimation techniques. The TCI required for a new steam stripper system is calculated as a direct function of the BEC. These estimation procedures are described more specifically in the following section.

5.1.1.1 Basic Equipment Costs. To determine the BEC, the base equipment must be identified and sized. The design of the base equipment that makes up the steam stripper system presented in Chapter 4.0, Figure 4-1 was based on a combination of information gathered previously<sup>1,2</sup> and design

evaluations performed using the Advanced System for Process Engineering (ASPEN),<sup>3</sup> a computer software for designing distillation columns.

Wastewater stream organic compound concentrations and total wastewater throughputs vary widely within the target industries. For the purpose of sizing the base equipment composing the steam stripper system, a wastewater stream with an organic compound concentration of 2,500 parts per million by weight (ppmw) (0.25 percent) at various wastewater throughputs was chosen. A sensitivity analysis, measuring the effect of organic compound concentration upon the removal efficiency while the remaining parameters were held constant, was performed using ASPEN.<sup>4</sup> The organic compound concentration was varied from 300 to 30,000 ppmw and the removal efficiency of the steam stripper was monitored. The results of the sensitivity analysis showed that the removal efficiency was not significantly affected by differences in organic compound concentration at set design and operating parameters. Additionally, five organic compounds were chosen, based on ranges of Henry's Law constants, to represent the range of organic compound strippability with the target industries. Table 4-2 in Chapter 4.0 presents the example wastewater stream characteristics and steam stripper design and operating parameters.

The wastewater storage tank was sized conservatively to provide a retention time of 48 hours for the stripper feed stream. It was also assumed that five batch and/or continuous streams would be combined for treatment by the same steam stripper, and each process wastewater stream would require approximately 300 m (980 ft) of connective piping. This design is based on conservative estimates. That is, the average storage tank may require less retention time; fewer than five streams may be combined for treatment; and less connective piping than the 300 m (980 ft) assumed for this costing exercise may be needed for each stream.



All equipment in the steam stripper unit was designed using ASPEN. The steam stripper column is designed as a sieve tray unit with countercurrent flow. The column is operated at a typical steam-to-wastewater feed ratio of 0.096 kilograms (kg) (0.212 pounds [lb]) of steam per liter of wastewater. The liquid loading of the column is 39,900 liters per hour per square meter ( $\ell/\text{hr}/\text{m}^2$ ) (980 gallons per hour per square foot [ $\text{gal}/\text{hr}/\text{ft}^2$ ]). Based on ASPEN results, an average removal of 80 percent is predicted for the five compounds.

A sensitivity analysis, similar to the one described above, was performed to determine the effect of the column height on the total annualized cost. The ASPEN simulations were conducted at column heights varying from 11.6 to 30.5 m (38.1 to 100 ft) with all other parameters remaining constant. The resulting difference in the ASPEN-generated total annualized cost between the shortest and tallest columns was approximately 1.5 percent. Because of the relatively small difference in annual costs, emphasis was placed on generating a design that would be most cost effective, be within practical design parameters, and would remove virtually 100 percent of the highly volatile compounds. The controlling compound used for design purposes was benzene. A column height of 9 m (30 ft) with a total of 10 sieve trays is used for the steam stripper unit.

The overheads from the steam stripper are recovered with a condenser unit consisting of a water cooled shell-and-tube heat exchanger. The condenser is designed for an outlet vapor temperature of 50 °C (120 °F) with an overall heat-transfer coefficient (U) of 1,000 joules per square meter per second per degree kelvin ( $\text{J}/\text{m}^2/\text{s}/\text{K}$ ) (5,680 Btu per square foot per hour per degree rankine [ $\text{Btu}/\text{ft}^2/\text{hr}/\text{R}$ ]). The organic phase of the overhead stream is recovered from the overheads decanter. The overhead vapor from the primary condenser is assumed to be vented to the feed storage tank and then routed to an existing on-site combustion or other control device.

The bottoms from the steam stripper are pumped to the existing wastewater treatment facility. Before being discharged from the stripper system, the bottoms pass through a feed preheater to enhance the efficiency of the steam stripper. The overall heat transfer coefficient used by ASPEN for the feed preheater is  $1,000 \text{ J/m}^2/\text{s/K}$  ( $5,680 \text{ Btu/ft}^2/\text{hr/R}$ ).

Pumps are installed to transfer the wastewater from the feed tank to the stripper, from the stripper to the feed/bottoms heat exchanger, from the decanter to the collection pot, and from the collection pot to storage.

Noncondensable gases are vented through the feed storage tank and decanter, which is vented to a flare. A flare arrestor is installed in this vent line to the flare to prevent flame propagation back into the steam stripper feed tank.

Steam stripper costs are estimated using the equipment sizes generated by ASPEN.<sup>3</sup> The cost of each piece of process equipment is determined from published engineering cost estimation techniques. Table 5-1 presents equations for the costs of the various components of the steam stripper system.<sup>5</sup> All costs are for carbon steel construction except for sieve trays and pumps. It was assumed that these components would be constructed of stainless steel since they take the greatest wear and are exposed to the harshest conditions. Table 5-2 summarizes the estimated equipment costs calculated for each component, the estimated size or capacity, the construction material, and the reference or information source used to obtain the cost estimate for a 300 liters per minute (lpm) (80 gallons per minute [gal/min]) capacity treatment system. Initial estimates were based on equipment costs for the year in which the textbook or journal article was published. These costs were then adjusted to July 1989 dollars using the Chemical Engineering fabricated equipment index for the appropriate month and year. The adjusted cost for each individual component was summed to yield the BEC for the design steam stripper.

TABLE 5-1. EQUIPMENT COST EQUATIONS FOR A STEAM STRIPPING UNIT

Equipment component	Costing equation <sup>a,5</sup>	Cost index <sup>b</sup>	Qualifier <sup>c</sup>	Cost reference
Feed Tanks	$\exp[2.331+1.3673*\ln(v)-0.063088*\ln(V)^2]$	230.9	1,300 gal < V ≤ 21,000 gal	7
	$\exp[11.362-0.6104*\ln(v)+0.045355*\ln(v)^2]$		21,000 gal < V < 11,000,000 gal	7
Feed Preheater	$\exp[8.551-0.30863*\ln(A)+0.06811*\ln(A)^2]$	230.9	150 ft <sup>2</sup> < A < 12,000 ft <sup>2</sup>	7
	$(\exp[-1.1156+0.0906*\ln(A)])$			
Steam Stripper	$(1A + 1B + 1C + 2A + 2B + 2C + 2D)/2$	230.9	9020 lb < W <sub>S</sub> < 2,470,000 lb	8
1A. Column Shell, Skirts, Nozzles and Manholes	$\exp[6.823+0.14178*\ln(W_S)+0.02468*\ln(W_S)^2]$			
1B. Platforms and Ladders	$151.81*D_i (0.63316)*L_t (0.80161)$	230.9	3 ft < D <sub>i</sub> < 24 ft; 57.5 ft < L <sub>t</sub> < 170 ft	8
1C. Sieve Trays- Stainless Steel	$0.85*(1.189+0.0577*D)^*$ $(\text{No. of Trays})*278.38*\exp[0.1739*D]$	225.9	2 ft < D < 16 ft	8
2A. Column Shell	$83.69*W_S (0.6124)$	225.9	1,000 lb < W <sub>S</sub> < 70,000 lb	9
2B. Manholes	$(\text{No. of Manholes})*18*(53.83+40.71*TS)$	225.9	0.375 in. < T <sub>S</sub> < 2 in.	9
2C. Nozzles	each nozzle length $\sum_{i=1}^n (\text{No. of nozzles})*(\text{length of nozzles, inch})*[24.57+35.94*TS]$	225.9	0.375 in. < T <sub>S</sub> < 2 in.	9
2D. Sieve Trays- Stainless Steel	$(\text{no. of Trays})*214.54*\exp[0.2075*D_i]$	225.9	2 ft < D <sub>i</sub> < 12.5 ft	9
Primary Condenser	$2228.8*\exp[0.00411*A]$	343	37.5 ft <sup>2</sup> < A < 240 ft <sup>2</sup>	10
	$5328.8*\exp[0.0008762*A]$	343	240 ft <sup>2</sup> < A < 1500 ft <sup>2</sup>	10
Overhead Collection Decanter	$74.55*(V)^0.5662$	225.9	100 gal < V < 100,000 gal	11

TABLE 5-1. EQUIPMENT COSTS EQUATIONS FOR A STEAM STRIPPING UNIT (Concluded)

Equipment component	Costing equation <sup>a,5</sup>	Cost index <sup>b</sup>	Qualifier <sup>c</sup>	Cost reference
Flame Arrestor	\$100/arrestor	319	NA	12
Pumps - Stainless Steel	$8740.7 * W^{(0.4207)}$ ; W in hp	347.8	10 gpm < Q < 150 gpm	10
	$13783.4 * W^{(0.2890)}$ ; W in hp	347.8	30 gpm < Q < 900 gpm	10

<sup>a</sup>All cost equations are based on components constructed of carbon steel except the equations for sieve trays and pumps. Cost equations for these two components are based on construction with stainless steel.

<sup>b</sup>The July 1989 Chemical Engineering fabricated equipment cost index is 356.0. To calculate costs in July 1989 dollars, multiply the equations in the table by the ratio of 356.0 to the cost index given in the table.

<sup>c</sup>

- A = Surface Area
- D = Steam stripper outside column diameter
- D<sub>i</sub> = Steam stripper inside column diameter
- L<sub>t</sub> = Steam stripper tangent-to-tangont length
- Q = Flow rate through component
- T<sub>S</sub> = Steam stripper column wall thickness
- V = Volume of component
- W = work
- W<sub>S</sub> = Steam stripper column weight.

TABLE 5-2. ESTIMATION OF BASIC EQUIPMENT COST FOR A STEAM STRIPPING UNIT

Equipment component	Equipment size <sup>a</sup>	Construction material	Equipment costs <sup>b</sup>	Cost reference
Feed Tanks	960 m <sup>3</sup>	Carbon Steel	\$75,000	7
Feed Preheater (Shell and Tube)	240 m <sup>2</sup>	Carbon Steel	\$32,000	7
Steam Stripping Column & Trays	0.76 m diameter 9 m height	Carbon Steel Trays-Stainless	\$52,000	8,9
Primary Condenser (Water Cooled, Shell & Tube)	22 m <sup>2</sup>	Carbon Steel	\$6,000	10
Overhead Collection Decanter	3.9 m <sup>3</sup>	Carbon Steel	\$6,000	11
Pumps (4)	6,300 total Watt	Stainless Steel	\$44,000	10
TOTAL BASE EQUIPMENT COST (BEC)			\$215,000	

<sup>a</sup> Based on 300 lpm wastewater flow.

<sup>b</sup> July 1989 dollars.

NA = Not Applicable.

5.1.1.2 Total Capital Investment.<sup>6</sup> As previously discussed, the TCI required to install a new steam stripper unit can be calculated as a direct function of the BEC value. The TCI for the steam stripper unit and the values of each component of the TCI are presented in Table 5-3. The PEC is calculated by multiplying the BEC by an appropriate percentage value. This percentage value and the other multipliers discussed below are selected from ranges recommended in cost estimation reference documents. Piping costs are implicitly included in the direct installation costs; however, auxiliary piping (i.e., additional piping for the combination of wastewater streams and vapor vent lines for storage tanks) and flame arrestors are accounted for separately in the PEC. Instrumentation, sales tax, and freight are also components of the PEC.

The PEC is used to estimate the steam stripper system direct installation costs and indirect installation costs. Each of these costs is calculated by multiplying the PEC by an appropriate percentage value. The direct installation costs include items such as electrical wiring, insulation, equipment support and erection, and painting of equipment. The indirect installation costs include engineering, construction and field expense, construction fee, start-up and testing, and contingency. The total of PEC, direct installation costs, and indirect installation costs yields the TCI. The TCI can also include costs for buildings, offsite facilities, land, working capital, and yard improvements; however, these costs are not typically included in the PEC for a steam stripper system.

5.1.1.3 Total Capital Investment Versus Wastewater Throughput. The TCI for installing a new steam stripper system is presented in Figure 5-1 as a function of wastewater feed rate. The TCI costs for this graph were calculated using the cost equations in Table 5-3 and are based on steam stripper designs sized for five different wastewater flow rates chosen arbitrarily: 40, 150, 300, 455, and 760  $\ell$ pm (10, 40, 80, 120, and 200 gal/min). Figure 5-1 presents TCI costs

TABLE 5-3. ESTIMATION OF TOTAL CAPITAL INVESTMENT  
FOR A STEAM STRIPPING UNIT<sup>a, b</sup>

Cost component	Cost factor	Component cost <sup>a</sup>	Total capital investment	Cost reference
<u>Direct Equipment Costs</u>				
Base Equipment Costs (BEC)	TABLE 5-2	\$215,000		
Piping <sup>c</sup>	\$8.48/m	\$14,500		13
Flame Arrestor	\$100/Arrestor	\$100		12
Instrumentation	0.1 * [BEC + Pipe + Arrestor]	\$23,000		14
Sales Tax and Freight	0.08 * [BEC + Pipe + Arrestor]	\$18,400		14
Purchased Equipment Cost (PEC)			\$270,900	
<u>Direct Installation Costs</u>				
Foundations and Supports	12% of PEC	\$32,500		14
Electrical	1% of PEC	\$2,700		14
Erection and Handling	40% of PEC	\$108,400		14
Painting	1% of PEC	\$2,700		14
Insulation	1% of PEC	\$2,700		14
TOTAL DIRECT INSTALLATION COST			\$149,000	
<u>Indirect Installation Costs</u>				
Engineering and Supervision	10% of PEC	\$27,100		14
Construction & Field Expense	10% of PEC	\$27,100		14
Construction Fee	10% of PEC	\$27,100		14
Start-Up and Testing	1% of PEC	\$2,700		14
Contingency	3% of PEC	\$8,100		14
TOTAL INDIRECT INSTALLATION COST			\$92,100	
TOTAL CAPITAL INVESTMENT (TCI)			\$512,000	

<sup>a</sup> July 1989 Dollars.

<sup>b</sup> Based on 300 lpm wastewater flow.

<sup>c</sup> Additional piping for combination of five wastewater streams is assumed to total approximately 1500 m. Vapor vent lines on the storage tank, condenser, and decanter route noncondensable VOC's back to the storage tank, or to a vapor recovery or control device. Each vent line is assumed to be 61 m in length and constructed of 5.1 cm diameter schedule 40 steel pipe.

5-10

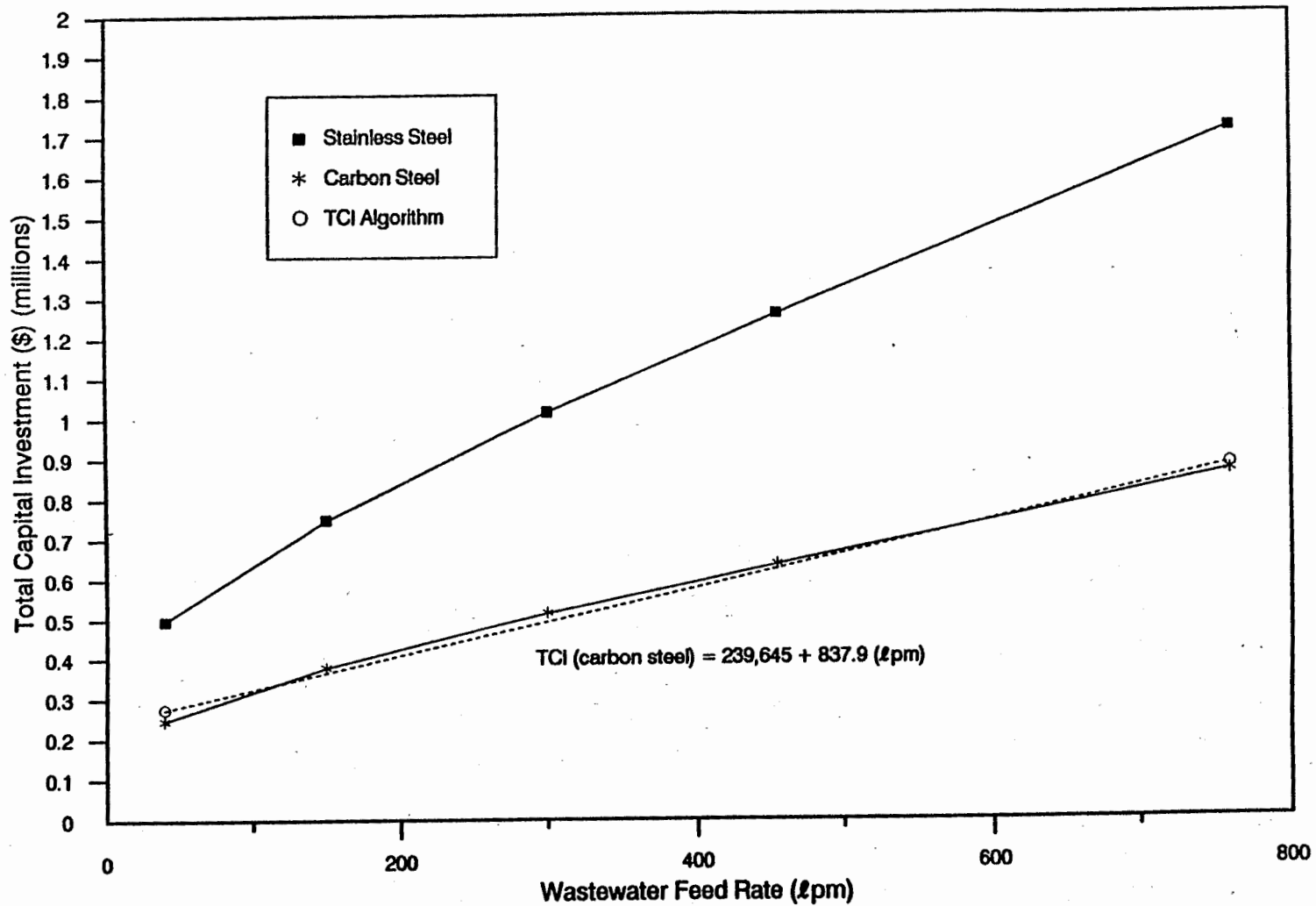

Figure 5-1. Summary of total capital investment versus wastewater feed rate for steam stripping unit.

5826744R



for both carbon steel and stainless steel construction. Stainless steel construction costs are included for comparison of streams with corrosive wastewater (i.e., very high or low pH). Equipment costs for stainless steel were developed from the same information sources used for carbon steel equipment costs. Generally, a factor for material of construction was used for conversion of carbon steel to 304 stainless steel. The TCI for a steam stripper system constructed of stainless steel is approximately 2.0 times more costly than a system constructed of carbon steel.

Based on the TCI costs for the five different wastewater flow rates, a linear expression was developed to estimate the TCI for steam stripper systems as a function of the wastewater feed rate.<sup>15</sup> The TCI for carbon steel construction can be estimated from the following equation:

$$\begin{array}{l} \text{TCI} \\ \text{(Carbon Steel, \$)} \end{array} = 239,645 + 837.9 * \begin{array}{l} \text{(Wastewater} \\ \text{Feed Rate, lpm)} \end{array}$$

This cost algorithm is also presented in Figure 5-1. Use of this equation in estimating the national impacts of applying RACT to the affected industries is presented in Appendix B.

#### 5.1.2 Basis for Annualized Costs

Total annualized costs (TAC) are the costs incurred to operate the steam stripper process unit throughout the year. The annual operating costs are composed of direct and indirect charges. The TAC and each of its components are presented in Table 5-4, and are discussed in detail in the following sections.

5.1.2.1 Total Annualized Cost. Direct annual costs are composed of the expenses that are incurred during normal operation of the steam stripper process. These costs include utilities, labor, and maintenance activities. Three types of utilities are required to operate the steam stripper process unit: electricity, steam, and cooling water. Electricity is required to operate pumps and other electrical components included in the system. The electricity required for the pumps is calculated assuming a developed head of approximately

TABLE 5-4. ESTIMATION OF TOTAL ANNUAL COST FOR A STEAM STRIPPING UNIT<sup>a, b</sup>

Cost component	Cost factor	Annual consumption	Annual cost	Cost reference
<b>Direct Annual Costs</b>				
Utilities				
Electricity	\$0.0509/kWhr	45,300 kWhr <sup>c</sup>	\$2,300	16
Steam	\$7.68/Mg	17,200 Mg <sup>d</sup>	\$132,200	16
Cooling Water	\$0.0528/1,000 liter	470,000,000 liters <sup>e</sup>	\$24,800	17
Labor				
Operating Labor	\$13.20/hr	450 hrs	\$5,900	14
Supervision & Admin	15% of Op. Labor		\$900	14
Maintenance				
Labor	\$14.50/hr	450 hrs	\$6,500	14
Materials	100% of Maint. Labor		\$6,500	14
<b>TOTAL DIRECT ANNUAL COST (TDAC)</b>			<b>\$179,100</b>	
<b>Indirect Annual Costs</b>				
Overhead	60% of All Labor and Materials		\$11,900	14
Property Taxes	1% of TCI		\$5,100	14
Insurance	1% of TCI		\$5,100	14
Administrative Charges	2% of TCI		\$10,200	14
Capital Recovery (CR)	10% @ 15 yrs		\$67,400	
<b>TOTAL INDIRECT ANNUAL COST (TIAC)</b>			<b>\$99,700</b>	
RECOVERY CREDIT (RC)			\$10,900 <sup>f</sup>	18
TOTAL ANNUAL COST (TAC)	TDAC + TIAC - RC		\$267,900	
ANNUAL WASTE THROUGHPUT (AWT)		129,400 Mg/yr		
COST PER UNIT WASTEWATER (\$/MG)	TAC/AWT		\$2.07/Mg	
COST PER LITER WASTEWATER FEED (\$/ℓ)	TAC/FLOW	160,000,000 ℓ/yr	\$0.00167/ℓ	

<sup>a</sup> July 1989 dollars.

<sup>b</sup> Based on 300 ℓpm wastewater flow.

<sup>c</sup> 150 kWhr/day, 300 days/yr.

<sup>d</sup> 57,300 kg/day, 300 days/yr.

<sup>e</sup> 1,570,000 ℓ/day, 300 days/yr.

<sup>f</sup> Recovery credit based on approximately 28,000 KJ/Kg heating value (see Ref. 18).

37 m (120 ft) of water and a pump efficiency of 64 percent, and using design flow rates to each pump. The steam costs are estimated using the design steam loading: 0.096 kg steam per liter (0.80 lb/gal) of wastewater feed. Streams containing highly volatile compounds may be effectively treated using lower steam loadings, resulting in reductions in annual operating cost. Appendix B discusses how lower steam requirements for streams containing highly volatile compounds are accounted for in estimating national impacts. The cooling water cost is calculated using water requirements necessary for the overhead primary condenser. Other direct costs include labor and maintenance. Labor cost is calculated by multiplying the estimated number of hours required to operate a steam stripper process unit (0.5 hour per shift) by a \$13.20 per hour labor rate. The supervisory and administrative costs are estimated as 15 percent of operating labor. The maintenance costs are composed of labor and materials. Maintenance labor cost is estimated assuming 0.5 hours per shift operation and a \$14.50 per hour labor rate. Maintenance materials cost is 100 percent of maintenance labor cost.

The indirect operating expenses are incurred regardless of the operating status of the steam stripper system. The cost of overhead is estimated to be 60 percent of all labor and maintenance costs. The remaining components of the indirect annual costs are a percentage of the TCI. Property taxes and insurance are both estimated to be 1 percent of the TCI while administrative charges are estimated to be 2 percent of the TCI. The capital recovery for the steam stripper system is calculated based on a 15-year equipment life at an interest rate of 10 percent.

Another aspect of the TAC included in this estimate is the recovery credit. This factor accounts for any cost credits that would result from the organic compounds being recovered from the overheads stream. There are several alternatives for handling the recovered organic compounds. If steam is produced onsite, the recovered organic compounds can

be used as fuel for the existing boiler. The money saved by not having to purchase conventional fuels (i.e., fuel oil or natural gas) is the recovery credit. In this situation, the value of the recovered compounds is equal to the fuel value only. Another option is to reuse the recovered organic compounds in the manufacturing process. In some cases the organic compounds can be recycled directly to the process; in other cases the organic compounds must be separated by distillation before reuse. The savings from reducing the purchase of raw materials is the recovery credit and is valued at the cost of the recovered organic compounds; however, this cost savings may be offset by the cost of distillation for the recovered organic compounds. Another option for the recovered organic compounds is to sell them to a chemical manufacturer who will recover the individual components in the waste organic stream. However, in cases where a cost-effective use for the recovered organic compounds does not exist, the plant would have to pay for disposal of the collected organic compounds. There will be no cost savings in this case; in fact, an additional cost for disposal may be incurred.

For this cost estimate it is assumed that the organic compounds can be used as fuel for an existing boiler. A heating value of approximately 28,000 kJ/kg (12,000 Btu/lb) was calculated based on the range of VOC concentrations reported in responses to a Section 114 survey of the organic chemicals, plastics, and synthetic fibers (OCPSF) industry.<sup>18</sup>

The organic compounds used to calculate the heating value were chosen based on the highest concentration values of compounds reported in the Section 114 questionnaire responses: acrylonitrile, carbon tetrachloride, ethanol, formaldehyde, styrene, toluene, and triethylamine. The cost of generating steam is reported to be two to three times more than the fuel cost in Perry's Chemical Engineers' Handbook.<sup>19</sup> Therefore, to assess a cost savings for burning organic compounds in place of a typical fuel used (i.e., coal, distillate/residual oil,

etc.), the typical fuel cost was assumed to be the steam cost divided by 2.5. The resulting fuel cost is  $\$1.3 \times 10^{-6}/\text{KJ}$  ( $\$1.4 \times 10^{-6}/\text{Btu}$ ). The recovery credit is calculated by multiplying the organic compound removal per year by the calculated organic compound heating value and the estimated fuel cost. This calculation is presented in a memorandum entitled "Development of Recovery Credit for Volatile Organic Compounds Removed from Wastewater Streams by Steam Stripping."<sup>18</sup>

5.1.2.2 Total Annualized Costs Versus Wastewater Throughput. The TAC for operating a steam stripper system is presented in Figure 5-2 as a function of wastewater feed rate. The development of this linear expression is presented in a memorandum.<sup>15</sup> The TAC's for this graph were calculated using the cost factors in Table 5-4 and are based on the same wastewater flow rates as the TCI costs in Figure 5-1: 40, 150, 300, 455 and 760  $\ell\text{pm}$  (10, 40, 80, 120, and 200 gal/min). Figure 5-2 presents TAC for both carbon steel and stainless steel construction. The TAC for a steam stripper system constructed of stainless steel is approximately 3 times more costly than a system constructed of carbon steel.

Based on the TAC for the five different wastewater flow rates (shown in Figure 5-2), a linear expression was developed to estimate the TAC for steam stripper systems as a function of the wastewater feed rate.<sup>15</sup> The TAC for carbon steel construction can be estimated from the following equation:

$$\begin{array}{l} \text{TAC} \\ \text{(Carbon Steel, \$/yr)} \end{array} = 72,812 + 639.1 * \begin{array}{l} \text{(Wastewater} \\ \text{Feed Rate, } \ell\text{pm)} \end{array}$$

The annualized unit operating cost ( $\$$  per liter) for the steam stripper system is calculated by dividing the total annualized operating cost ( $\$$  per year) for the steam stripper system operating cost by 300  $\ell\text{pm}$  (80 gal/min). The resulting annualized unit operating cost is approximately  $\$0.0017$  per liter ( $\$0.0064$  per gallon). Annualized unit operating costs were also estimated for the other four wastewater flow rates.

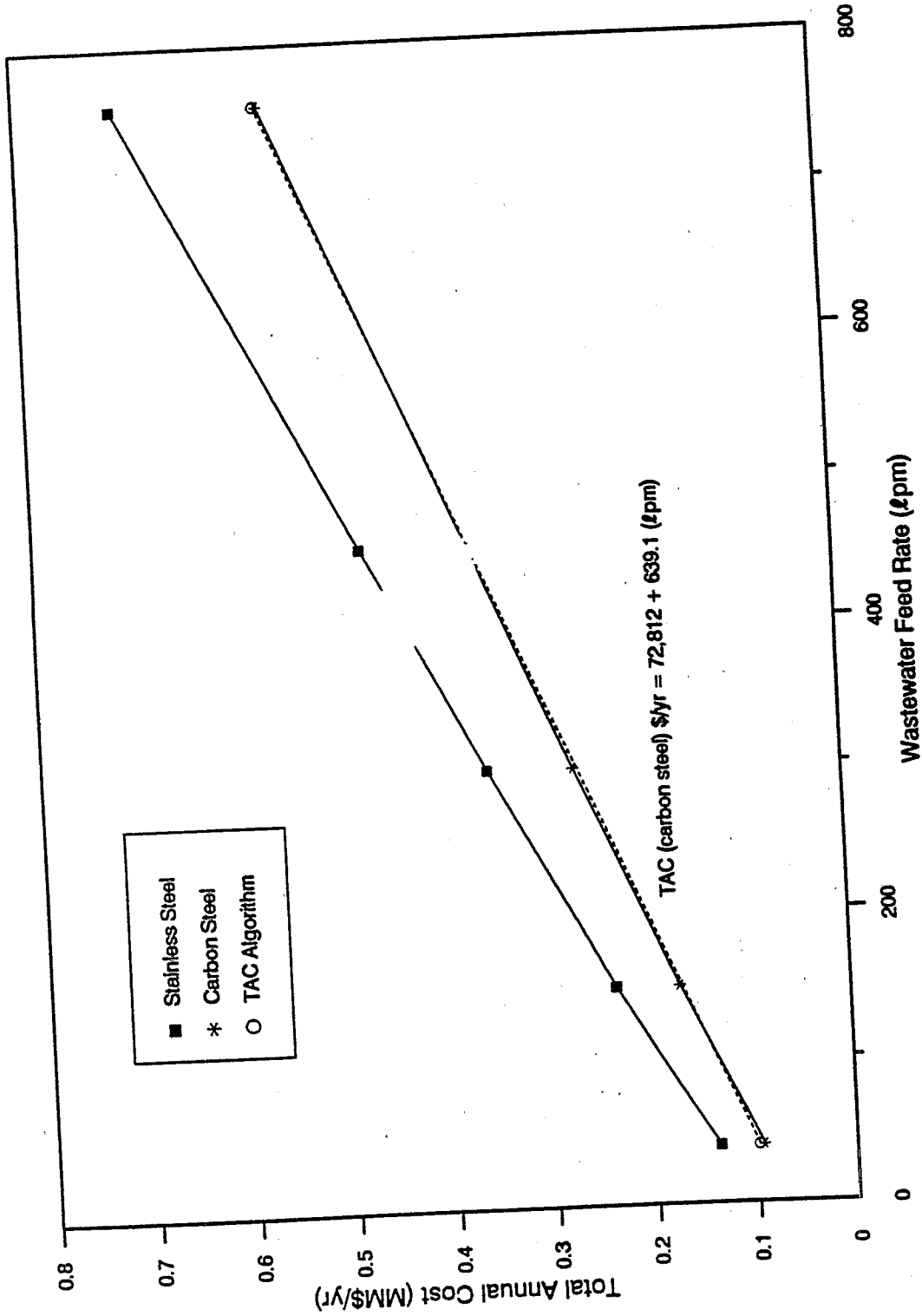

Figure 5-2. Total annual cost versus wastewater feed rate for steam stripping unit.

5826742R

The results of these cost estimates are presented in Figure 5-3 as an indirect function of the wastewater feed rate to the steam stripper system. This figure shows that the unit operating cost is nearly constant at flow rates of 300 lpm (80 gal/min) and greater. At flow rates less than 300 lpm (80 gal/min) there is a significant increase in the unit operating costs. These facts illustrate that it is most economical to treat larger flow rates of wastewater up to about 300 lpm (80 gal/min). There is no significant reduction in TAC at flow rates greater than 300 lpm (80 gal/min).

The TAC equation presented above was used in estimating the cost impacts and calculating the cost effectiveness of applying RACT to the affected industries. These impact calculations are presented in Appendix B.

## 5.2 ENVIRONMENTAL AND ENERGY IMPACTS OF STEAM STRIPPING

The purpose of this section is to evaluate the environmental and energy impacts associated with steam stripping. Steam stripping effectively reduces potential air emissions of volatile organic compounds (VOC's) during downstream wastewater collection and treatment and also improves water quality. Analysis of the environmental impacts of this control technique included an evaluation of the air and water pollution impacts, impacts on waste disposal, pollution prevention, and energy use. Section 5.2.1 presents an assessment of primary air pollution impacts (VOC emissions); Section 5.2.2 presents secondary air pollution impacts resulting from fuel combustion for production of steam; and Section 5.2.3 discusses water pollution, solid waste, pollution prevention, and energy impacts.

### 5.2.1 Primary Air Pollution Impacts--Volatile Organic Compound Emission Impacts

The reduction in VOC emissions that can be achieved by steam stripping a wastewater stream is dependent on the stripper design and the characteristics of the wastewater streams (i.e., flow rate, composition, and concentration).

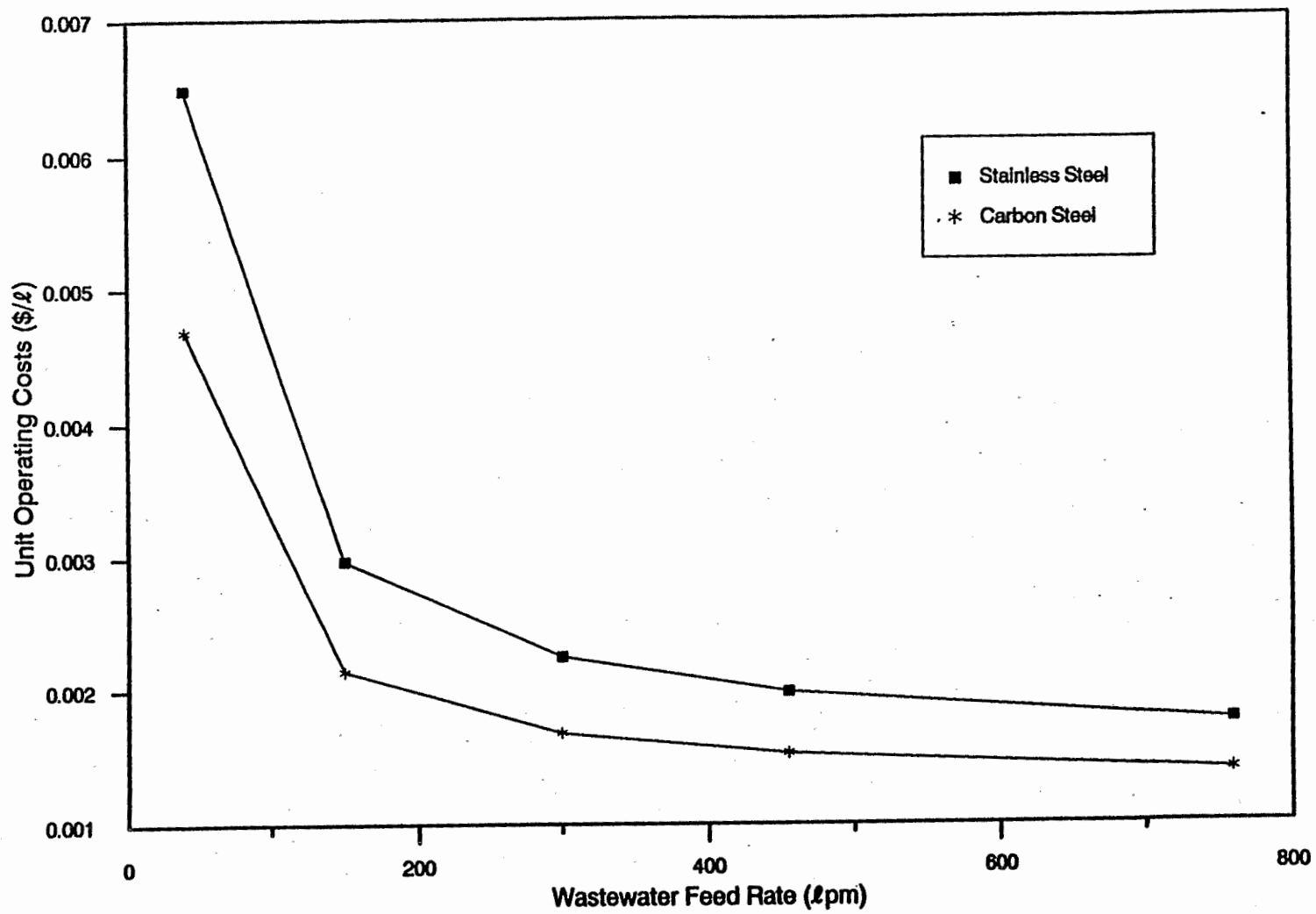

Figure 5-3. Unit operating costs versus wastewater feed rate for steam stripping unit.



Table 5-5 presents VOC emission reductions achievable through steam stripping for the example model wastewater stream. Also presented in Table 5-5 are baseline VOC emissions. National estimates of VOC emission reductions resulting from the application of reasonably available control technology (RACT) to the affected industries have been calculated using the procedure summarized in Table 5-5 and are presented in Appendix B.

#### 5.2.2 Secondary Air Pollution Impacts

Secondary air impacts occur from combustion of fossil fuels for steam and electricity generation. Combustion pollutants formed include particulate matter (PM), sulfur dioxide (SO<sub>2</sub>), nitrogen oxides (NO<sub>x</sub>), carbon monoxide (CO), and VOC's. Although pollutants can be formed during steam and electricity generation, only steam generation was assumed to occur onsite; therefore, impacts from offsite electricity generation are not discussed here. The secondary emissions presented in this section were estimated using the EPA emission factors presented in Table 5-6.<sup>21</sup> Assumptions concerning the fuel composition and boiler efficiency are based on information compiled by the Agency and the Energy Information Administration.<sup>22,23</sup> These values were adjusted to accommodate emission reductions by existing control devices. Typical controls and control efficiencies presented in these sources were assumed.

The industrial boiler used for steam generation was assumed to have a capacity of less than 158 million kJ/hr (150 million Btu/hr). A thermal efficiency of 80 percent was assigned to the industrial boiler as an average expected value. It is assumed to be controlled for SO<sub>2</sub>, PM, and NO<sub>x</sub> emissions using desulfurization (90 percent SO<sub>2</sub> removal efficiency), an electrostatic precipitator (99 percent PM removal efficiency), and flue gas recirculation (assuming the mid-range of 40 percent NO<sub>x</sub> removal efficiency).<sup>24,25</sup> Fuel composition was based on national fuel use for industrial boilers: natural gas at 45 percent, residual oil at

TABLE 5-5. VOLATILE ORGANIC COMPOUND EMISSION REDUCTION FOR STEAM STRIPPING

Compound	Waste stream organic compound concentration (ppmw)	Fraction emitted (fe)	Fraction measured $F_m^a$	Volatile organic concentration (ppmw) <sup>b</sup>	Fraction removed $Fr^c$
1,3-Butadiene	500	0.933	1.00	500	1.00
Toluene	500	0.733	1.00	500	1.00
Naphthalene	500	0.62	1.00	500	1.00
1-Butanol	500	0.30	0.68	385	0.92
Phenol	500	0.10	0.057	30	0.089

a Surrogate fraction measured by draft EPA Reference Method 25D.20

b VO Concentration (ppmw) = Waste stream organic compound concentration (ppmw) \*  $f_m$

c Fraction removed by the steam stripper is based on ASPEN results for the design steam stripper.<sup>3</sup>

1. Baseline VOC emissions (Mg/yr) =  $0.683 * \Sigma \text{VO Conc (mg/l)} * \text{Flow (lpm)} * 10^{-9} \text{ (Mg/mg)} * 525,600 \text{ (min/yr)}$

where: 0.683 = a proportionality constant representing the fraction of total organic compounds in a wastewater stream that would be emitted to the air (fe) divided by the fraction of total organic compounds in a wastewater stream measured by Draft Reference Method 25D ( $f_m$ ) (see Appendix B).

Flow = 300 lpm

$\Sigma \text{VO Conc} = 1915 \text{ ppmw}$

Baseline VOC emissions (Mg/yr) = 206 Mg/yr

2. VOC Emission Reduction (Mg/yr) = Baseline VOC Emissions \* fr avg

where:  $fr \text{ avg} = \Sigma (\text{VOC}_i * fe_i * fr_i) / \Sigma (\text{VOC}_i * fe_i) = 1343/1285 = 0.96$   
 VOC Emission Reduction (Mg/yr) = 198 Mg/yr

TABLE 5-6. COMBUSTION POLLUTANT EMISSION FACTORS FOR STEAM GENERATION

	PM	SO <sub>2</sub>	NO <sub>x</sub>	CO	VOC	Heating Value
Natural Gas						
(kg/10 <sup>5</sup> m <sup>3</sup> )	4.8	1.0	440	64	2.2	
(lb/10 <sup>6</sup> ft <sup>3</sup> )	3.0	0.62	275	40	1.4	
(KJ/m <sup>3</sup> )						3.8 x 10 <sup>3</sup>
(Btu/ft <sup>3</sup> )						1.0 x 10 <sup>3</sup>
Residual oil						
(kg/m <sup>3</sup> ) <sup>a</sup>	1.6	19.0	6.6	0.60	0.034	
(lb/gal)	0.013	0.16	0.055	0.0050	0.00028	
(KJ/m <sup>3</sup> )						4.2 x 10 <sup>7</sup>
(Btu/gal)						1.5 x 10 <sup>5</sup>
Distillate oil						
(kg/m <sup>3</sup> ) <sup>a</sup>	0.24	17.0	2.4	0.60	0.024	
(lb/gal)	0.002	0.14	0.020	0.0050	0.00020	
(KJ/m <sup>3</sup> )						3.8 x 10 <sup>7</sup>
(Btu/gal)						1.4 x 10 <sup>5</sup>
Pulverized Coal						
(g/kg)	60.0 <sup>b</sup>	29.0 <sup>c</sup>	11.0	0.30	0.035	
(lb/lb)	0.06	0.029	0.011	0.00030	0.000035	
(KJ/kg)						2.8 x 10 <sup>4</sup>
(Btu/lb)						1.2 x 10 <sup>4</sup>

<sup>a</sup>Assumes 1.0 percent sulfur content in the fuel oil.

<sup>b</sup>Factor derived from the EPA emission factor given as 10A, where A = % ash in coal, which was assumed to be a typical value of 12 percent.

<sup>c</sup>Factor derived from the EPA emission factor given as 39S, where S = % sulfur in coal, which was assumed to be the mid-range at 1.5 percent.

28 percent, distillate oil at 7 percent, and coal at 20 percent.<sup>22</sup> Average heating values are presented in Table 5-6.

Estimated emissions, based on these assumptions, were calculated as follows:

$$\begin{array}{l} \text{Uncontrolled} \\ \text{Emissions} \\ \text{(Mg/yr)} \end{array} = \begin{array}{l} \text{Annual Fuel Use} \\ \text{(m}^3\text{/yr)} \end{array} * \begin{array}{l} \text{Emission Factor} \\ \text{(Kg/10}^5\text{m}^3\text{)} \\ \text{(see Table 5-6)} \end{array}$$

and

$$\begin{array}{l} \text{Controlled} \\ \text{Emissions} \\ \text{(Mg/yr)} \end{array} = \begin{array}{l} \text{Uncontrolled} \\ \text{Emissions} \\ \text{(Mg/hr)} \end{array} * (1 - \text{Control Efficiency})$$

(see Table 5-6)

The resulting secondary emission estimates for the example wastewater stream are presented in Table 5-7. National secondary impact estimates were calculated for the application of RACT to the affected industries using the emission factors presented in Table 5-6. These impacts are presented in Appendix B.

Handling the recovered organics for disposal may also contribute to secondary air impacts. For example, incineration of recovered organic compounds produces combustion pollutants as a secondary impact. However, the recovered organic compounds could be used as an alternate energy source, i.e., to generate some of the steam required by the steam stripper. Although combustion of the organic compounds will produce combustion pollutants, the emissions of SO<sub>2</sub> and PM will typically be less than those generated by fossil fuel combustion. This is due primarily to two factors: (1) most organic compounds do not contain sulfur, which reacts to form SO<sub>2</sub> when burned, and (2) organic compounds do not contain high concentrations of inorganics, which are emitted as particulates when burned. If recovered organic compounds are recycled (i.e., not combusted), then they do not contribute to the secondary air impacts.

### 5.2.3 Other Impacts

5.2.3.1 Water Pollution Impacts. Steam strippers remove organic compounds from the wastewater, thereby improving the

TABLE 5-7. SECONDARY AIR POLLUTION IMPACTS OF EXAMPLE WASTEWATER STREAM<sup>a</sup>

Wastewater stream flow rate (lpm)	Emission reduction with steam stripping (Mg/yr)	Pollutant emissions (Mg/yr)				
		PM <sup>b</sup>	SO <sub>2</sub> <sup>b</sup>	NO <sub>x</sub> <sup>b</sup>	CO	VOC
300	200	0.18	1.5	4.5	0.6	0.03

<sup>a</sup>Fuel composition for steam generation is based on 45, 28, 7, and 20 percent natural gas, residual oil, distillate oil, and coal, respectively.

<sup>b</sup>SO<sub>2</sub>, NO<sub>x</sub>, and PM controls reduce emissions by 90, 40, and 99 percent, respectively.<sup>24,25</sup>

quality of wastewater being discharged to wastewater treatment plants or to publicly owned treatment works (POTW). The EPA has established effluent guideline standards for 51 industrial categories, for both conventional (i.e., biochemical oxygen demand [BOD]), and for a list of 126 specific chemicals, or priority pollutants. Some facilities have installed steam strippers to meet the effluent guideline standards for organic priority pollutants. Steam strippers also remove other organic compounds, not listed as priority pollutants, which may be present in the wastewater. Therefore, steam strippers reduce the total organic loading of wastewater, and also positively impact conventional wastewater pollutants, chiefly BOD.

5.2.3.2 Solid and Hazardous Waste Impacts. Solid and hazardous waste can be generated from three possible sources: organic compounds recovered in the steam stripper overheads condenser, solids removed during feed pretreatment, and wastes generated in the control of system vent emissions. System vent emissions, if not sent to a combustion control device, may be collected on a sorbent medium that requires either disposal or regeneration. If the sorbent is disposed of, it creates additional solid waste.

Although waste generation can increase for any nonrecyclable organics that cannot be used as supplemental fuel, these organic wastes most likely would have been removed otherwise from the wastewater via the air (volatile organics only) or via an oil/water separator. Similarly, solids removed from the wastewater in cases where pretreatment is necessary would have likely been removed in a clarifier or activated sludge unit.

5.2.3.3 Pollution Prevention. As described in Chapter 4.0, the condenser unit in a steam stripping system is used to recover the organic and water vapors in the overheads stream. The organics recovered are usually either pumped to storage and then recycled to the process or burned as fuel in a combustion device such as the steam-generating boiler.

If the organics are used as fuel, this represents a pollution prevention credit by reducing the usage of conventional fuels. For organic compounds recovered for use in the manufacturing process, the pollution prevention credit is the reduction in the amount of raw materials that must be used in the process. Another option for recovered organic compounds is to sell them to a chemical manufacturer who will recover the separate components of the waste organic compound stream.

5.2.3.4 Energy Impacts. The additional fuel demand to generate steam for the steam stripper system reduces available nonrenewable resources: coal, oil, and natural gas. This can be partially offset if the recovered organics are used as supplementary fuel or if they are recycled. (Recycling reduces the facility demand for petroleum-derived feedstocks.)

Table 5-8 summarizes the annual fuel usages for steam generation for the example wastewater stream. These values are based on the steam stripper design presented in Chapter 4.0 and the boiler capacity and efficiencies discussed previously. The fuel composition assumed for steam generation is as follows: 45 percent natural gas, 28 percent residual oil, 7 percent distillate oil, and 20 percent coal. These percentages were based on national fuel-use data for industrial boilers.<sup>22</sup>

TABLE 5-8. ANNUAL FUEL USE FOR STEAM GENERATION  
FOR STEAM STRIPPER CONTROL OF  
EXAMPLE WASTEWATER STREAM<sup>a</sup>

Wastewater stream flow rate ( $\ell$ pm)	Fuel	Percent composition <sup>b</sup>	Annual use
300	Natural gas	45	$4.79 * 10^5 \text{ m}^3$ ( $1.69 * 10^7 \text{ ft}^3$ )
	Residual oil	28	$279 \text{ m}^3$ ( $7.36 * 10^4 \text{ gal}$ )
	Distillate oil	7	$74.6 \text{ m}^3$ ( $1.97 * 10^4 \text{ gal}$ )
	Coal	20	$2.92 * 10^5 \text{ kg}$ ( $6.43 * 10^5 \text{ lb}$ )

<sup>a</sup>Based on steam stripper design in Chapter 4.0.

<sup>b</sup>Based on national fuel use for industrial and electrical  
generating boilers.



### 5.3 REFERENCES

1. Letter from Plant B to J. Farmer, U. S. Environmental Protection Agency, Office of Air Quality Planning and Standards (Confidential Section 114 response.) November 1986.
2. OWRS Data, June 12, 1985. JRB/SAIC. Costing Documentation and National New Information. EPA Contract No. 68-01-6947.
3. U. S. Environmental Protection Agency. ASPEN Expert System for Steam Stripping Calculations. EPA 450/3-90-003. July 1990.
4. Memorandum from C. Zukor, Radian Corporation to Project File. Sensitivity Analysis on Design Variables for the Steam Stripping Unit in the Hazardous Organic NESHAP (HON). February 3, 1992.
5. Memorandum from C. Zukor, Radian Corporation to P. E. Lassiter, Office of Air Quality Planning and Standards, U. S. Environmental Protection Agency, Research Triangle Park, N.C. Development of Equipment Cost Equations for a Steam Stripping Unit. January 24, 1992.
6. U. S. Environmental Protection Agency. EAB Control Cost Manual. Chapter 2: Cost Estimating Methodology. 4th Edition. Office of Air Quality Planning and Standards. EPA 450/3-90-006. Research Triangle Park, North Carolina. January 1990. pp. 2-5 to 2-8.
7. Corripio, A. B., K. S. Chrien, and L. B. Evans. Estimate Costs of Heat Exchangers and Storage Tanks via Correlations. Chemical Engineering. January 25, 1982. pp. 144 to 146.
8. Corripio, A. B., A. Mulet, and L. B. Evans. Estimate Costs of Distillation and Absorption Towers via Correlations. Chemical Engineering. December 28, 1981. p. 180.
9. Peters, M. S., and K. D. Timmerhaus. Plant Design and Economics for Chemical Engineers. 3rd ed. New York: McGraw-Hill Book Company. 1980. pp. 768 to 773.
10. Hall, R. S., W. M. Vataavuk, J. Matley. Estimating Process Equipment Costs. Chemical Engineering. November 21, 1988. pp. 66 to 75.
11. Reference 9, p. 572, Figure 13-58.

12. Teleconference. A. Gitelman, Research Triangle Institute, with Hoyt Corporation. Cost of Flame Arrestors. September 9, 1986.
13. Richardson Engineering Services, Inc. Richardson Process Plant Construction Estimation Standards: Mechanical and Electrical. Volume 3. Mesa, Arizona. 1988. Section 15-40, pp. 1 to 9.
14. Vatavuk, W. M., and R. B. Neveril. Part II: Factors for Estimating Capital and Operating Costs. Chemical Engineering. November 3, 1980. pp. 157 to 182.
15. Memorandum from C. Zukor, Radian Corporation to P. E. Lassiter, Office of Air Quality Planning and Standards, U. S. Environmental Protection Agency, Research Triangle Park, N.C. Development of Total Capital Investment (TCI) and Total Annual Cost (TAC) Equations for the Steam Stripping Unit in the Hazardous Organic NESHAP (HON). February 3, 1992.
16. Memorandum from P. Peterson, Research Triangle Institute, to S. Thorneloe, Office of Air Quality Planning and Standards, U. S. Environmental Protection Agency. Basis for Steam Stripping Organic Removal Efficiency and Cost Estimates Used for the Source Assessment Model (SAM) Analysis. January 18, 1988.
17. Reference 6, p. 4-27.
18. Memorandum from C. Zukor, Radian Corporation to P. E. Lassiter, Office of Air Quality Planning and Standards, U. S. Environmental Protection Agency, Research Triangle Park, N.C. Development of Recovery Credit for Volatile Organic Compounds Removed from Wastewater Streams by Steam Stripping. January 20, 1992.
19. Perry, R. H., and C. H. Chilton. Chemical Engineers' Handbook. 5th ed. New York: McGraw-Hill Book Company. 1973. pp. 25 to 29.
20. Memorandum from Brailsford, J., Radian Corporation, to Elaine Manning, U.S. Environmental Protection Agency. Regarding Calculation of  $f_m$ . December 3, 1991.
21. Compilation of Air Pollutant Emission Factors. Volume I: Stationary Point and Area Sources. U. S. Environmental Protection Agency. Office of Air Quality Planning and Standards. Research Triangle Park, NC. Publication No. AP-42, September 1985, and Supplement A, October 1986. pp. 1.1-2, 1.3-2, 1.4-2.

22. Fossil Fuel Fired Industrial Boilers - Background Information. U. S. Environmental Protection Agency. Office of Air Quality Planning and Standards. Research Triangle Park, NC. Volume I: Chapters 1-9. Draft EIS. Publication No. EPA-450/3-82-006a. March 1982. pp. 3-12 to 18.
23. Electric Power Quarterly, April to June 1984. Energy Information Administration. U. S. Department of Energy. Washington, D. C. Publication No. DOE/EIA-0397C84/2Q. October 1984. pp. 19, 20.
24. Reference 21, pp. 1.3-9, 1.3-4.
25. Reference 21, pp. 1.1-5, 1.1-6.

100

101

102

103

104

105

106

107

108

109

110

111

112

113

114

115

116

117

118

119

120

121

122

123

124

125

126

127

128

129

130

131

132

133

134

135

136

137

138

139

140

141

142

143

144

145

146

147

148

149

150

151

152

153

154

155

156

157

158

159

160

161

162

163

164

165

166

167

168

169

170

171

172

173

174

175

176

177

178

179

180

181

182

183

184

185

186

187

188

189

190

191

192

193

194

195

196

197

198

199

200

## 6.0 SELECTION OF REASONABLY AVAILABLE CONTROL TECHNOLOGY

This chapter provides State and local regulatory authorities with guidance on the selection of reasonably available control technology (RACT) for volatile organic compound (VOC) emissions from industrial wastewaters generated in six targeted industries: organic chemicals, plastics, and synthetic fibers (OCPSF); pharmaceuticals; pesticides manufacturing; petroleum refining; pulp, paper, and paperboard, builder's paper, and board mills (pulp and paper); and hazardous waste treatment, storage, and disposal facilities (TSDF). Background on the regulatory authority and goals for establishment of RACT is discussed in Section 6.1. Options and impacts of RACT on the selected subgroup of industries studied in this control techniques guideline (CTG) are presented in Section 6.2. Section 6.3 describes the selection of RACT.

### 6.1 BACKGROUND

The Clean Air Act (CAA) Amendments of 1990 mandate that State implementation plans (SIP's) for ozone nonattainment areas be revised to require the installation of RACT to limit VOC emissions from sources for which a CTG document has already been published or for which a CTG document will be published between the date the Amendments are enacted and the date an area achieves attainment status. Section 182(b)(2). The Agency defines RACT as "...the lowest emission limitation that a particular source is capable of meeting by the application of control technology that is reasonably available, considering technological and economic feasibility. The RACT for a particular industry is determined on a case-by-

case basis, considering the technological and economic circumstances of the individual source category."<sup>1</sup>

The CTG documents are intended to provide State and local air pollution authorities with an information base for proceeding with their own analysis of RACT to meet statutory requirements. These documents review existing information and data concerning the technical capability and cost of various control techniques to reduce emissions. Each CTG document contains a recommended "presumptive norm" for RACT for a particular source category, based on the Agency's current evaluation of capabilities and problems general to the source category. However, the presumptive norm is only a recommendation. Where applicable, the Agency recommends that regulatory authorities adopt requirements consistent with the presumptive norm. However, authorities may choose to develop their own RACT requirements on a case-by-case basis, considering the economic and technical circumstances of the individual source category within an area. To achieve attainment of the ozone standard, regulatory authorities may need to require a higher degree of control than recommended.

The EPA is developing national emission standards for hazardous air pollutants (NESHAP) for the six industries addressed in this CTG. These future NESHAP will define maximum achievable control technology (MACT) standards for organic hazardous air pollutant (HAP) emissions from wastewater. The control approach to reduce HAP emissions is the same as the approach outlined in the CTG; identify certain streams for control and treat them to reduce air emissions. Because most organic HAP are also VOC and other VOC often would also be found in the HAP-containing streams, the MACT standards will get some control of VOC emissions. For most industries, however, many VOC-containing wastewater streams do not contain HAP and therefore, controlling only HAP-containing streams, as would be required under a MACT standard, would not substantially reduce VOC emissions. This would, in general, indicate that there is a need for both MACT standards to

regulate HAP emissions and a CTG to control non-HAP VOC emissions in nonattainment areas. For the pulp and paper and petroleum refining industries, however, the Agency presently believes that wastewater streams that contain non-HAP VOC also contain a substantial amount of HAP. Therefore, the MACT standards for these industries will substantially reduce VOC emissions. For this reason, the recommended RACT outlined in the CTG is not suggested for the pulp and paper and petroleum refining industries.

Three of the pharmaceutical subcategories were excluded from the RACT option analysis because the wastewater flow characteristics from these pharmaceutical subcategories are believed to represent a small VO loading relative to the other industries included in the analysis. More specifically, although wastewater flow from fermentation processes is relatively high, the VOC concentration is low; both the wastewater flow rate and VOC concentration is low from formulation processes; and extraction processes are characterized by low flow rates.

## 6.2 REASONABLY AVAILABLE CONTROL TECHNOLOGY OPTIONS AND IMPACTS

Reasonably available control technology for VOC emissions from industrial wastewater is the application of a controlled collection and treatment system to individual wastewater streams that fail the cutoff criteria. A controlled collection and treatment system is defined as hard-piping or a controlled collection system from the point of wastewater generation to a controlled removal or destruction device that has all associated vents and openings controlled. Example requirements for a controlled collection and treatment system can be found in the "National Emission Standards for Hazardous Air Pollutants (NESHAP) for Benzene Waste Operations" (40 CFR 61 Subpart FF).<sup>2</sup> Residuals (condensed and decanted organics) removed from a controlled collection and treatment system should be contained in a controlled storage vessel and recycled within the process or disposed of properly.

The technology underlying RACT for removal of VOC from wastewater is steam stripping. Steam stripping is a proven wastewater treatment technology for wastewaters generated within each of the targeted industries. It is generally applicable to wastewater streams with the potential to emit VOC and, in general, achieves the highest VOC emission reduction among demonstrated VOC control technologies. A controlled steam stripper can achieve greater than 98 percent VOC reduction (see control efficiencies of operating steam strippers in Table 4-2 in Chapter 4.0). Details on the recommended steam stripper system are presented in Chapter 4.0. The cost basis for the control costs presented in this chapter is the design steam stripper system as presented in Chapter 5.0. Although the performance and cost of applying RACT to the affected industries is based on the application of a controlled collection and treatment system, with steam stripping as the VOC removal technology, there are other technologies that can be considered for removal of VOC from wastewater. These technologies (air stripping, biodegradation, carbon and ion exchange adsorption, chemical oxidation, membrane separation, and liquid-liquid extraction) should, however, achieve at least the recommended control level (as defined by the capabilities of the design steam stripper).

#### 6.2.1 Reasonably Available Control Technology Options Formats

In defining RACT for control of VOC emissions from wastewater, the presumptive norm specifies which streams to control and how to control them. One approach to determine which wastewater streams to control is to make the decision based only on the volatile organic (VO) concentration of the wastewater stream, as detected by proposed reference Method 25D (56 FR 33544, July 22, 1991)<sup>3</sup>. All wastewater streams exceeding the VO concentration cutoff would require control regardless of the flow rate. This approach has the advantage of requiring measurement of only one parameter, that is, VO concentration. This approach also ensures that all



streams highly concentrated with VO are controlled. A concentration-only approach could potentially achieve a high degree of emission reduction; however, it would likely do so by requiring control of wastewater streams with low flow rates that have relatively low VO loadings and are less cost effective to control. In this approach, there could also be some high-flow-rate wastewater streams with relatively high VO loadings that would be reasonable to control but would escape control because Method 25D results indicate a low VO concentration.

Another approach to determine which wastewater streams to control is to make the decision to control based only on the flow rate of each wastewater stream. All individual streams exceeding the flow rate cutoff would require control. This approach has the advantage of requiring measurement of only one parameter, that is, flow rate. A flow-rate-only approach could potentially achieve a high degree of emission reduction; however, it would likely do so by controlling wastewater streams with low VOC emissions that are less cost effective to control. In this approach, there could also be some wastewater streams with high VOC emissions that would be cost effective to control but would escape control because they have a low flow rate.

A third approach to determine which wastewater streams to control is to establish a combination of a minimum VO concentration (as determined by Method 25D) and minimum flow rate. The VO concentration and flow rate would be determined for each individual wastewater stream. Any wastewater stream exceeding both the VO concentration and flow rate would be required to be controlled. This approach would reduce the number of low-flow-rate (and, therefore, low-emission-rate) streams that would require control under the concentration-only approach. It would also reduce the number of wastewater streams with low VO concentrations (and, therefore, low-emission-rates) that would have required control under the flow-rate-only approach.

The third approach described above can be combined with a maximum VO concentration, above which a wastewater stream is controlled, regardless of flow. This provides for control of those wastewater streams which fall below the minimum flow rate, but have a sufficiently high VO concentration such that they are cost effective to control.

Options for the recommended presumptive norm for RACT have been identified based on the combination of a minimum VO concentration and minimum flow rate with a maximum VO concentration of 10,000 parts per million by weight (ppmw) above which a wastewater stream is controlled, independent of flow rate. Thus, the impacts analysis assumes that any wastewater stream having both a flow rate and VO concentration above the selected cutoff values or a VO concentration greater than 10,000 ppmw (independent of flow rate) will be controlled to a level achievable by the steam stripper system design presented in Chapter 4.0.

#### 6.2.2 Reasonably Available Control Technology Options Impacts

Table 6-1 summarizes the estimated national impacts of various control options for the recommended presumptive norm for RACT. These impacts were estimated for wastewater streams from the following industrial categories:

- Pharmaceutical Industry
  - Chemical Synthesis Subcategory
- Pesticides Manufacturing Industry
- OCPSF Industry
  - Organic Chemical Industry
  - Plastics Industry
  - Synthetic Fibers Industry
- Hazardous Waste TSDF Industry

The above list of industrial categories considered in the RACT option analysis does not include all the industries presented previously in this document. The pulp and paper and the petroleum refining industries were excluded from RACT based on the reasoning presented in Section 6.1. Additionally three of the pharmaceutical subcategories were excluded from

TABLE 6-1. TOTAL INDUSTRY RACT NATIONAL IMPACTS

RACT option description			VOC emission reduction (Mg/yr)	Percent VOC emission reduction	Total national capital cost (\$MM)	Total national annual cost (\$MM/yr)	National cost effectiveness (\$/Mg)	Incremental cost effectiveness (\$/Mg)
VOC concentration cutoff (ppmw)	Flow rate cutoff (#pm)	Maximum VOC concentration (ppmw)						
1,000	10	10,000	232,000	83%	190	100	430	
500	1	10,000	244,000	88%	240	120	480	1,400
200	1	10,000	251,000	90%	300	150	610	5,700
100	1	10,000	252,000	91%	330	170	690	13,800
TIC			255,000	92%	600	380	1,500	65,900

\*All options include a maximum VOC concentration cutoff of 10,000 ppmw.  
 Baseline VOC Emissions = 278,000 Mg/yr  
 Total Wastewater Volume = 563,000 #pm  
 Total Number Wastewater Streams = 8,100  
 TIC = Total Industry Control

the RACT option analysis which is also discussed in Section 6.1.

The impacts presented include VOC emission reduction (Mg per year), percent emission reduction, total national capital and annual costs (million dollars and million dollars per year), and national and incremental cost effectiveness (\$ per Mg).

A detailed description of the technical approach for the impacts analysis are summarized in Appendix B. Reasonably available control technology impact summaries for each of the individual industrial categories described in this document are also presented in Appendix B.

### 6.3 SELECTION OF REASONABLY AVAILABLE CONTROL TECHNOLOGY

Table 6-1 summarizes the impacts of various options for the recommended presumptive norm for RACT. After review of the impacts in Table 6-1, the Agency has selected a VO concentration cutoff of 500 ppmw and a flow rate cutoff of 1 lpm as the recommended presumptive norm for RACT in this draft CTG. This cutoff level would reduce an estimated 88 percent of the available VOC emissions at an estimated cost of 120 million dollars per year. For discussion on the approach for estimating the national impacts presented in Table 6-1, see Appendix B.

The Agency has also selected a facility-wide loading cutoff based on the annual total VO loading of the affected streams in a facility. The facility-wide loading cutoff selected is 10 Mg/yr. This cutoff will serve to exempt small facilities with a low annual total VO loading, or allow larger facilities to exempt certain streams from their control requirements. The facility-wide loading cutoff is based on streams that must be controlled as determined by the 500 ppmw concentration and 1 lpm flow rate cutoff. Further explanation of the facility-wide loading cutoff is in section 7.3.1.

#### 6.4 REFERENCES

1. Federal Register. State Implementation Plans; General Preamble for Proposed Rulemaking on Approval of Plan Revisions for Nonattainment Areas-Supplement (On Control Techniques Guidelines) 44 FR 53761 to 53763. September 17, 1979.
2. Federal Register. National Emission Standards for Hazardous Air Pollutants; Benzene Emissions From Chemical Manufacturing Process Vents, Industrial Solvent Use, Benzene Waste Operations, Benzene Transfer Operations, and Gasoline Marketing System. 55 FR 8292 to 8361. March 7, 1990.
3. Federal Register. Hazardous Waste Treatment, Storage, and Disposal Facilities; Organic Air Emission Standards for Tanks, Surface Impoundments, and Containers; Proposed Rule. 56 FR 33544 to 33555. July 22, 1991.

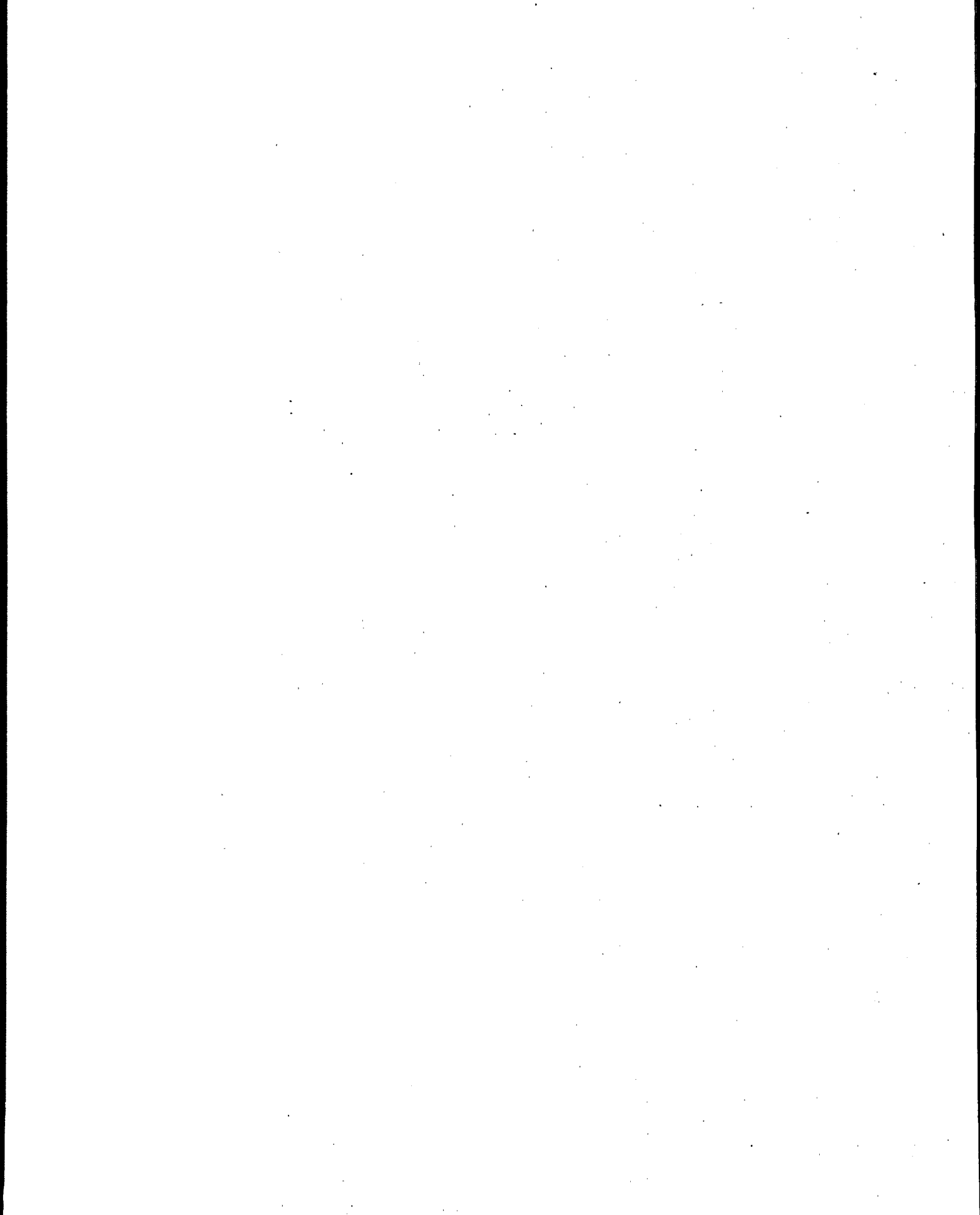

## 7.0 REASONABLY AVAILABLE CONTROL TECHNOLOGY IMPLEMENTATION

### 7.1 INTRODUCTION

This chapter presents guidance on factors State air quality management agencies should consider in developing an enforceable rule limiting volatile organic compound (VOC) emissions from the collection and treatment of industrial wastewater from the four affected industries: the organic chemicals, plastics, and synthetic fibers (OCPSF) industry; the pesticides industry; the pharmaceutical industry; and the hazardous waste treatment, storage, and disposal facilities (TSDF) industry. Guidance is provided on definitions of pertinent terms, applicability, emission limit format, performance testing requirements, monitoring requirements, and reporting/recordkeeping requirements.

For each aspect of implementation, this chapter identifies multiple options, presented for informational purposes only. Additionally, Appendix A contains an example rule incorporating the options provided in this document; the example rule is also for informational purposes only. Specific numerical limitations are given as guidance only, and should not be considered regulatory standards. The air quality management agency should consider all information presented in this chapter along with additional information made available to it from affected sources in adopting an actual rule.

### 7.2 DEFINITIONS

Air quality management agencies should accurately describe the types of emission sources affected by reasonably available control technology (RACT) and clearly define the four industries listed above and the applicable control

methods. This section offers guidance to agencies in selecting terms that may need to be clarified when used in a regulatory context. Example definitions of these terms are provided or sources are cited where definitions may be found and to which the agency may refer when drafting a RACT regulation for the affected source categories.

A description of each of the four affected industrial categories is found in Chapter 2.0 of this document. Useful terms defining volatile organic chemical (VOC) emission sources within the affected industrial categories include wastewater treatment and collection system components such as: "drains," "junction boxes," "lift stations," "manholes," "trenches," "sumps," "weirs," "oil/water separators," "equalization basins," "clarifiers," "aeration basins," "pH adjustment tanks," "flocculation tanks," and "surface impoundments." A discussion of these terms is given in Chapter 3.0 of this document.

Process modification techniques such as "waste minimization" and "source reduction" should be included as allowable options for the facility to use in complying with the rule. These terms are discussed in Section 4.1. Additionally, it may be helpful to explain emission control techniques such as "steam stripping," "air stripping," "chemical oxidation," "adsorption," "membrane separation," and "extraction." A discussion of the different emission control techniques is found in Section 4.2. Volatile organic chemical emission suppression components from collection and treatment units that may be defined include: "p-leg seals," "seal pots," "gas tight covers," "roof covers," "floating membrane cover," and "air-supported structures." Section 4.3 explains these different suppression components. Finally, add-on devices for the control of VOC emissions from wastewater treatment devices that may be defined include: "carbon adsorbers," "thermal vapor incinerators," "combination adsorption," "catalytic vapor incinerators," "flares,"



"boilers and process heaters," and "condensers." Section 4.3 also explains these add-on controls in detail.

A term that is important to the implementation of RACT is "point of generation." Point of generation means the location where the wastewater stream exits the process unit component or product or feed storage tank before handling or treatment in a piece of equipment that is not an integral part of the process unit. A piece of equipment is an integral part of the process unit if it is essential to the operation of the unit, i.e., removal of the equipment would result in the process unit being shut down. For example, a steam stripper column is part of the process unit if it produces the principal product stream and a wastewater that is discharged to the sewer. However, an identical stripper that treats a wastewater stream and recovers residual product would not be considered an integral part of the process unit. The point of generation for measurement or sampling is defined as the point where the wastewater stream exits the process unit before it is treated or mixed with other streams, and prior to exposure to the atmosphere. The point of generation for landfill leachate is at the pump well from which the leachate is pumped out of the landfill.

Another term that may require an explanation is "residuals." Residual means any material containing volatile organics (VO's) that is removed from a wastewater stream by a waste management unit that does not destroy organics (nondestructive unit). Examples of residuals from nondestructive waste-management units are the organic layer and bottom residue removed by a decanter or organic-water separator and the overhead condensate stream from a steam stripper or air stripper. Residuals do not include the effluent wastewater stream that complies with the treatment standards and that results from management or treatment of the influent wastewater stream to the waste management unit. Examples of materials that are not residuals are the effluent wastewater stream exiting a decanter or organic-water

separator after the organic layer has been removed; and the bottoms from a steam stripper or air stripper. Examples of destructive devices are biological treatment units and incinerators; sludges, ash, or other materials removed from the wastewater being treated by these devices are not considered residuals under this subpart.

Other terms that are important to the implementation of RACT are "VO concentration," "strippability," "VOC," and "loading." The term "VO concentration" refers to those organic compounds in a wastewater stream measured by proposed reference Method 25D (56FR 33544, July 22, 1991).<sup>1</sup>

"Strippability" refers to the degree to which organic compounds are removed from wastewater by steam stripping, and is expressed as the fraction removed (Fr). Highly volatile compounds exhibit a high Fr while compounds of lower volatility have a lower Fr. "Volatile organic compound" means any organic compound that participates in atmospheric photochemical reactions. An owner or operator may exclude the following organic compounds, designated as having negligible photochemical reactivity: methane, ethane, methyl chloroform (1,1,1-trichloroethane), CFC-113 (trichlorotrifluoroethane), methylene chloride, CFC-11 (trichlorofluoromethane), CFC-12 (dichlorodifluoromethane), CFC-22 (chlorodifluoromethane), FC-23 (trifluoromethane), CFC-114 (dichlorotetrafluoroethane), CFC-115 (chloropentafluoroethane), HCFC-123 (dichlorotrifluoroethane), HFC-134a (tetrafluoroethane), HCFC-141b (dichlorofluoroethane), and HCFC-142b (chlorodifluoroethane). "Loading" is a measure of the mass air emission potential of a wastewater stream, determined by multiplying the VO concentration in the wastewater by the annual quantity of the wastewater stream.

### 7.3 APPLICABILITY

The facilities that will be considered affected facilities are those processes and/or pieces of equipment that generate any organic-containing wastewater stream and that are within the affected source category. The three criteria that

define the affected source category are: (1) the facility is one of the four industries described in Section 7.1; (2) the facility is located in an area of nonattainment for ozone; and (3) the facility generates wastewater streams containing organic compounds. A detailed description of different sources of wastewater streams is presented in Chapter 3.0.

A series of figures has been prepared to illustrate applicability criteria for determining the level of control required for wastewater generated by affected facilities, treatment standards for wastewater streams requiring control, and levels of treatment needed for residuals. These figures are presented in the model rule included as Appendix A. These figures are used in the following discussion to define applicability and level of control required.

#### 7.3.1 Applicability Criteria

To determine the applicability to a wastewater stream, the flow and total VO concentration of that wastewater stream should be determined at the point of generation. If the stream has a total VO concentration equal to or greater than a maximum VO concentration 10,000 parts per million by weight (ppmw), or if the stream has a total flow greater than or equal to 1 lpm and a VO concentration greater than 500 ppmw, then the stream is defined as an affected stream.

After the affected streams have been determined, the facility-wide loading cutoff may be applied. The facility-wide loading cutoff is based on the annual VO loading of the affected streams in the facility. This loading cutoff will serve to exempt small facilities with a low annual total VO loading, or allow larger facilities to exempt certain streams from their control requirements. The Agency has selected 10 Mg/yr as the facility-wide loading cutoff. To utilize this option the facility would calculate the annual VO loading of individual streams exceeding the flow and concentration cutoffs at the point of generation. An individual stream equal to or less than the 10 Mg/yr cutoff or a combination of several streams totalling or less than the 10 Mg/yr cutoff

could be eliminated from control. If the facility-wide annual VO loading is equal to or below 10 Mg/yr the facility would be exempt from control.

Facilities that exceed the facility loading cutoff have the option of making process changes that will reduce the VO concentration and/or the quantity of wastewater at the point of generation for individual streams. Once process changes are made, the individual streams are reevaluated using the total VO concentration and flow rate criteria.

Facilities that do not use process changes to reduce their total VO loading below the cutoff may recycle affected streams back to the process or reduce the VO loading by using waste management units that are properly controlled for air emissions.

If it is possible to recycle or treat affected streams under either one or a combination of these options, then the annual total VO loading is reevaluated, based on the following summation: (Annual total VO loading at point of generation for untreated, affected streams) + (Annual total VO loading at the treatment process outlet for affected streams not treated to treatment standards [Section 7.4]). The loadings of affected streams recycled back to the process or fully treated to the treatment standards would not be included in the annual total VO loading reevaluation. Facilities that cannot use these options to reduce the VO concentration below the RACT concentration and flow rate cutoffs should be required to meet the treatment standards described in Section 7.4.

#### 7.4 FORMAT OF THE STANDARDS

The control of VOC emissions from wastewater comprises three different components: emission suppression and control of vapors from wastewater collection and treatment, wastewater treatment to reduce VO content in the wastewater, and treatment of residuals. Wastewater collection refers to transporting wastewater from the point of generation to a treatment unit. Wastewater treatment pertains to different techniques employed to reduce the mass of organic compounds in

the wastewater stream. Finally, the treatment of residuals refers to vapors from transport, handling, and treatment, as well as oil phases, condensates, and sludges removed from controlled wastewater streams. These residuals must be collected in a closed-vent system, then recycled or destroyed. Each of these three components are discussed separately below.

#### 7.4.1 Emission Suppression from Wastewater Collection

The recommended method for suppression of emissions from wastewater collection systems includes a combination of equipment standards and work practices. Equipment used to suppress emissions from wastewater collection and treatment systems includes covers, lids, roofs, and enclosures. Typically, the design of this equipment includes gasketing around all openings, doors, hatches, and sampling ports. Proper work practices are needed to ensure that the equipment will suppress emissions. Examples of work practices include: (1) annual monitoring for leaks; (2) visual inspection for cracks and gaps in the equipment, and (3) repair of deficiencies as soon as practical but no later than 5 calendar days after identification.

#### 7.4.2 Wastewater Treatment to Reduce Volatile Organic Content

Two formats are presented for the reduction of wastewater VO content. These are a numerical format and an equipment design and operation format. Since emission potential is a function of VO concentrations and wastewater flow rate, which can be measured directly, VO concentration and wastewater flow rate are used as the bases for the numerical format.

A total of four numerical emission limit formats are presented to provide facilities with a maximum degree of operational flexibility in demonstrating compliance: (1) an overall percent reduction of total VO in the wastewater stream; (2) percent reductions for individually speciated VO; (3) an effluent concentration limit for total VO; and (4) a required mass removal for VO. These four numerical formats and the equipment design format are discussed below.

7.4.2.1 Percent Reduction. The percent reduction format is based on the VO removal efficiency of a steam stripper, and should be considered as an alternative standard to an exclusive effluent concentration limit because of the wide variations in influent wastewater characteristics. Data available from steam strippers treating wastewater streams containing VO indicate that removal efficiencies of greater than 99 percent are achievable with a properly designed and operated system for treating compounds that are volatile. However, any treatment process that can achieve the proposed efficiency can be used to comply with the standard. Therefore, one form of a percent reduction standard that might be considered would be a required overall VO removal applicable both to streams that are treated individually and to those that are combined prior to treatment.

A second alternative percent reduction standard is based on the percent reduction for individually speciated VO. Some VOC's are highly soluble or have low volatilities and cannot be removed as easily by steam stripping as other compounds. Wastewater streams composed mostly of compounds with low volatility may not be able to achieve the total VO percent reduction. Therefore, the organic compounds have been grouped by Henry's Law constants into five strippability groups. Strippability refers to the predicted removal efficiency of a compound using the design steam stripper discussed in Section 4.2.1. These groups are shown in Table 7-1. The groups are ordered by decreasing strippability. Target percentage removals for VO in each group have been developed based on the range of Henry's Law constants for the compounds in that group. Facilities may choose to use this alternative standard in cases where individual or combined streams contain VO with low volatility, such as a stream containing phenol. This approach will result in adequate control of VOC air emissions within the full range of volatilities.

7.4.2.2 Effluent Concentration. The effluent concentration limits are also based on the performance of a

TABLE 7-1. VOLATILE ORGANICS STRIPPABILITY GROUPS  
AND TARGET REMOVAL EFFICIENCIES

Strippability Group	Henry's Law Constant Range (25°C)	Target removal efficiency
I	$H \geq 1.333 \times 10^{-3}$	99%
II	$1.3333 \times 10^{-3} > H \geq 7.499 \times 10^{-5}$	95%
III	$7.499 \times 10^{-5} > H \geq 2.208 \times 10^{-6}$	70%
IV	$2.208 \times 10^{-6} > H \geq 4.217 \times 10^{-7}$	25%
V	$4.217 \times 10^{-7} > H$	0%

steam stripper. Again, any treatment process that can achieve the proposed effluent concentration limits can be used to comply with the standard. Effluent concentration limits are provided as alternatives to the percent reduction standard to allow compliance flexibility for facilities required to treat individual streams having low VO concentrations.

Additionally, a percent reduction standard for these streams may require additional treatment with little reduction in emissions, since at very low concentrations it is more difficult and costly to achieve the same level of percent reduction.

7.4.2.3 Mass Removal. Required mass removal is an alternative for combined streams where streams requiring control might be mixed with other streams not requiring control. It is based on the removal performance of a steam stripper for the different volatility groups of compounds. The mass removal alternative was provided in lieu of concentration limits because concentration limits could be achieved by dilution of affected streams through combination with less concentrated affected streams or unaffected streams.

A series of treatment processes may be used to comply with this requirement. However, wastewater collection and treatment processes located between treatment processes being used to achieve the required mass removal should follow suppression or treatment formats. For example, if a combination of two steam strippers is used to achieve the required mass removal, and a tank is located between the two steam strippers, then the tank should be controlled to suppress emissions, even if not all streams entering the tank are defined as affected streams.

7.4.2.4 Equipment Design and Operation. Another regulatory format considered for wastewater treatment is an equipment design and operation format. The equipment standard consists of the installation of a steam stripper designed and operated at specified parametric levels, as discussed in Chapter 4.0. The specifications for the steam stripper were



developed to provide a standard piece of equipment (with associated operating conditions) that can achieve high removal of VOC's for most streams, and greater than 99 percent for streams containing primarily high-volatility compounds.

This equipment format was included to provide an alternative standard with which all facilities would be able to comply, while achieving the desired emission reduction. Steam strippers are universally applicable treatment devices that provide a consistently high level of VO removal. This treatment format is applicable for individual or combined streams.

In summary, five alternative standards are proposed for wastewater treatment. Four alternatives are based on a numerical format, and one is an equipment/operational format. This combination of alternatives using different formats provides a wide range of flexibility in complying with the standard and takes into consideration the variabilities in waste streams produced in the affected industry.

7.4.2.5 Alternative Treatment Standards. Alternative treatment standards are recommended when the wastewater streams within a process unit can be combined for treatment. To demonstrate compliance with these alternative treatment standards, a facility should be required to demonstrate that the total VO concentration of all streams (individual or combined) leaving the process unit is less than or equal to 10 ppmw. The VO concentration may be determined after combination with other streams and after treatment, but before exposure to the atmosphere.

#### 7.4.3 Treatment of Residuals

Residuals, defined in Section 7.2, must be controlled. It is suggested that facilities be given the following options for handling residuals: (1) return the residual to the process; (2) return the residual to a treatment device; or (3) destroy the total VO loading of the residual by at least 99 percent. Residual treatment and destruction devices are discussed in Chapter 4.0.

## 7.5 PERFORMANCE TESTING

Performance testing is required to demonstrate that the control devices chosen to comply with RACT requirements are capable of achieving the recommended performance standards or equipment design requirements. Testing is typically requested by the regulating agency at the time the regulatory standard is initially triggered at a facility and at any time thereafter that it is deemed necessary (usually on a continual or continuous basis). The initial test, or performance test, usually requires testing of influent and effluent concentrations and associated operating parameters, whereas a monitoring test may require the operator to record only those operating parameters met during the initial performance test. When the owner or operator of an affected facility conducts a performance test, the treatment process should be operating at the most demanding conditions the control device is expected to encounter. This section addresses performance testing. Monitoring requirements are addressed in Section 7.6.

### 7.5.1 Wastewater Collection

The purpose of performance testing for wastewater collection systems is to demonstrate that both the recommended equipment performance levels and work practices discussed in Section 7.4.1 are being met. The air quality management agency may require testing and/or inspection of emission reduction equipment to ascertain that this equipment is installed and maintained according to manufacturer's specification. The agency may also provide guidelines for operators to follow with respect to work practices (i.e., equipment leak monitoring).

### 7.5.2 Wastewater Treatment

The purpose of performance testing for wastewater treatment systems is to demonstrate that the recommended equipment performance levels and design requirements discussed in Section 7.4.2 are being met. The air quality management agency may require testing to determine that the facility is operating its equipment at design specifications to meet RACT

standards. For wastewater streams being controlled under a performance standard, testing to demonstrate that the required percent reduction or required mass removal is being achieved should be required. At a minimum, the air quality management agency should require the measurement of the influent and effluent VO concentrations.

### 7.5.3 Treatment of Residual Vapors from Wastewater Collection and Treatment Systems

It is recommended that the air quality management agency require initial performance testing of residual vapor destruction devices. A destruction efficiency should be required for flares and combustion devices, whereas a weight percent reduction format is recommended for such product recovery devices as carbon adsorbers, condensers, and absorbers.

## 7.6 MONITORING REQUIREMENTS

In implementing RACT, specific monitoring requirements should be required. One purpose of monitoring is to ensure that wastewater streams which are initially determined not to exceed the RACT cutoff criteria, continue to remain below the RACT cutoff level. A second purpose of monitoring is to demonstrate proper operation of a treatment device in place to control a stream exceeding the RACT cutoff criteria. The following is guidance on specifying requirements for monitoring.

### 7.6.1 Wastewater Collection

The air quality management agency should require evaluation of all collection systems that use a closed vent system to reduce emissions. It is suggested that this evaluation be conducted initially and at some periodic time interval to determine if any leaks are present. This evaluation can be conducted by visually inspecting seals, access doors, and openings for cracks, gaps, and improperly fitted gaskets, and/or using an approved test method (Reference Method 21). Suggested monitoring parameters and

frequencies for wastewater collection equipment are summarized in the model rule in Appendix A.

#### 7.6.2 Wastewater Treatment

In order to ensure that the facility is maintaining the control equipment selected to comply with the standards (i.e., steam stripper), the air quality management agency may require continuous monitoring of those parameters that indicate proper system operation. For a steam stripper, these parameters may include steam flow rate, liquid loading, wastewater feed temperature, and condenser vapor outlet temperature. If an alternative treatment is used to comply with the performance standard, the agency may consider requiring monitoring of influent and/or effluent streams for VO concentration, percent VO removal, or required mass removal on a regular basis, or monitoring specific operating parameters that provide an indication of the treatment device performance. Suggested monitoring parameters and frequencies for the different treatment formats are summarized in the model rule in Appendix A. A distinction between the different monitoring requirements for treatment of individual versus combined wastewater streams is also made in the model rule.

#### 7.6.3 Treatment of Residual Vapors from Wastewater Collection and Treatment Systems

The treatment of the vapors from residuals lends itself to a performance based standard, because there are numerous appropriate alternatives. The air quality management agency may want to require monitoring to ensure that these devices are operating properly. For incinerators, boilers, and condensers, the equipment's temperature may be the appropriate parameter to monitor on a continuous basis. An organic compound monitoring device may be recommended for carbon adsorbers and condensers. Suggested monitoring parameters and frequencies for different control devices used to comply with the standards are summarized in the model rule in Appendix A.

## 7.7 REPORTING/RECORDKEEPING REQUIREMENTS

For each facility subject to the RACT requirements, the air quality management agency should require reporting and recordkeeping of certain key parameters to indicate compliance. First, affected facilities should identify the control method selected to meet the RACT requirements. Next, the results of any performance test results should be recorded. It is also recommended that the facility record all parameters monitored on a routine basis to indicate continued compliance with the RACT emission limit. These parameters differ depending on the means by which the RACT requirements are met. Any exceedances of the monitored parameters listed should be recorded along with any corrective actions taken to correct the exceedance. The agency should specify which of the recorded data should be reported and what the reporting frequency should be. Guidance for recordkeeping and reporting requirements are provided in the model rule in Appendix A.

## 7.8 RELATIONSHIPS TO TITLE III (SECTION 112) OF THE CLEAN AIR ACT AMENDMENTS

Section 112 of the Clean Air Act, as amended November 1990, requires EPA to develop national standards for source categories that emit one or more of 189 hazardous air pollutants listed in Section 112(b). EPA is currently planning to promulgate a standard by November 1992 that will address hazardous air pollutants from the SOCOMI industry. This standard is referred to as the HON. It will cover process vents, equipment leaks, storage, transfer, and wastewater operations. Meanwhile, EPA is developing several CTG's which address some of these same types of emission points in the SOCOMI industry; these include reactor and distillation process vents, storage, and wastewater. EPA has already published CTG's for SOCOMI air oxidation process vents and equipment leaks.

The same basic control technology requirements are included both in the proposed HON and the CTG's (e.g., steam stripping). The only real difference between the draft CTG's

and the proposed HON is the applicability. There may be process vents, storage vessels, or wastewater streams in plants covered by the proposed HON that would not be subject to the Section 112 standards because they contain no HAP's or because they contain less HAP's than the specified applicability criterion. These same emission points, however, may contain enough VOC to meet the applicability criteria recommended in the CTG's (e.g., 1 lpm and 500 ppmw). The reverse could be true. An emission point could fall below a CTG-recommended cutoff and be above a HAP cutoff. The net effect is that a plant owner or operator may need to control more total emission points than he would under either requirement alone. Thus, even though the control technology would be the same under both sets of rules, the owner or operator may need a larger control device, for example, to control all the emission points addressed by the CTG and HON together. Being aware of the need for owners and operators to have a knowledge of both sets of requirements as they develop their control strategies, EPA's intent is to publish the CTG's on the same schedule as the promulgated Section 112 rule, if possible, so owners and operators are at least informed of the CTG recommendations (even though the actual State rules for the VOC sources may be different).

In the current draft version of the HON, compliance can be achieved using emissions averaging, which means that some emission points may remain uncontrolled as long as the requisite emission reductions are achieved at other emission points. However, these "averaged-out" emission points may still be subject to the requirements of RACT because of their VOC emissions. To minimize the constraints to flexibility with meeting the HON, such as described above, while at the same time not jeopardizing the VOC emission reductions that would be achieved by the installation of controls at CTG-affected points, EPA is planning to publish in the Federal Register for public comment a presumptive alternative RACT for those emission points that are affected by the HON and CTG's.

## 7.9 REFERENCES

1. Federal Register. Hazardous Waste Treatment, Storage, and Disposal Facilities; Organic Air Emission Standards for Tanks, Surface Impoundments, and Containers; Proposed Rule. 56 FR 33544 to 33555. July 22, 1991.

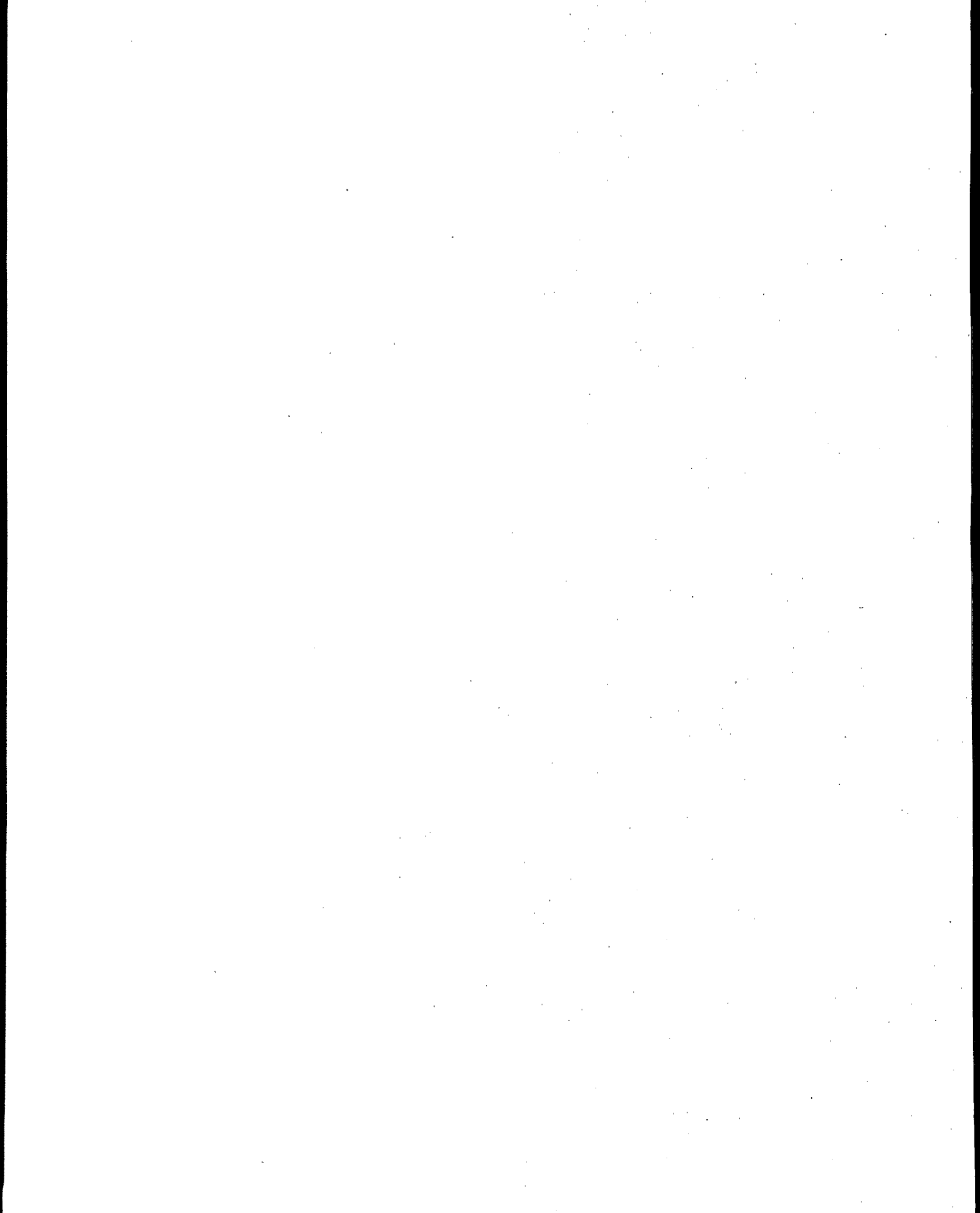



## APPENDIX A

### MODEL RULE

The model rule for the IWW CTG is being based on the HON. The HON is addressing hazardous air pollutant emissions from wastewaters generated in SOCFI, which is a subset of the OCPSF industry. The HON is presently undergoing revisions which will alter the model rule. Therefore the Agency has elected to not include a model rule in the draft version of the IWW CTG. The final document will include a complete model rule which will reflect any revisions to the HON.

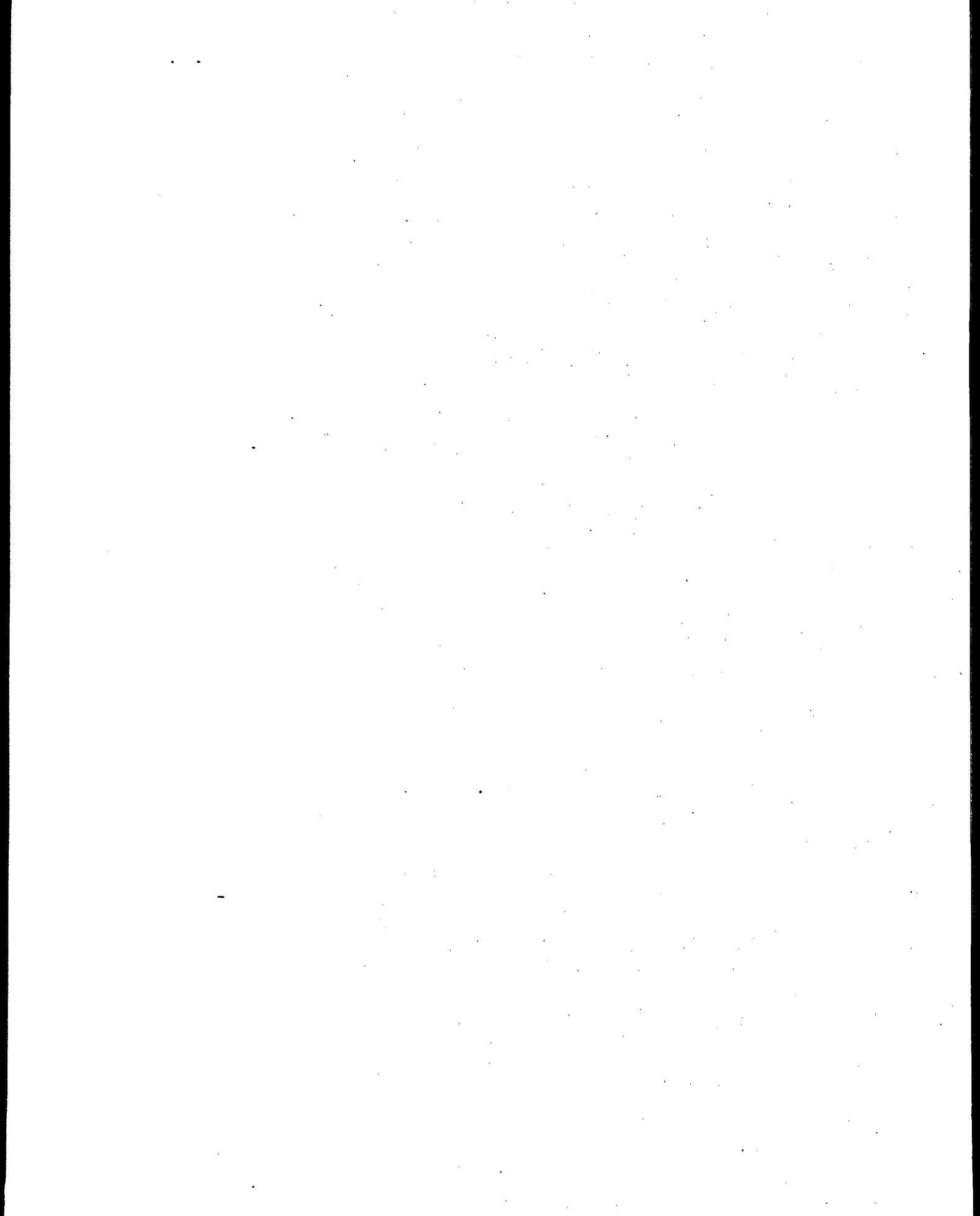

**APPENDIX B**  
**NATIONAL IMPACTS ANALYSIS**

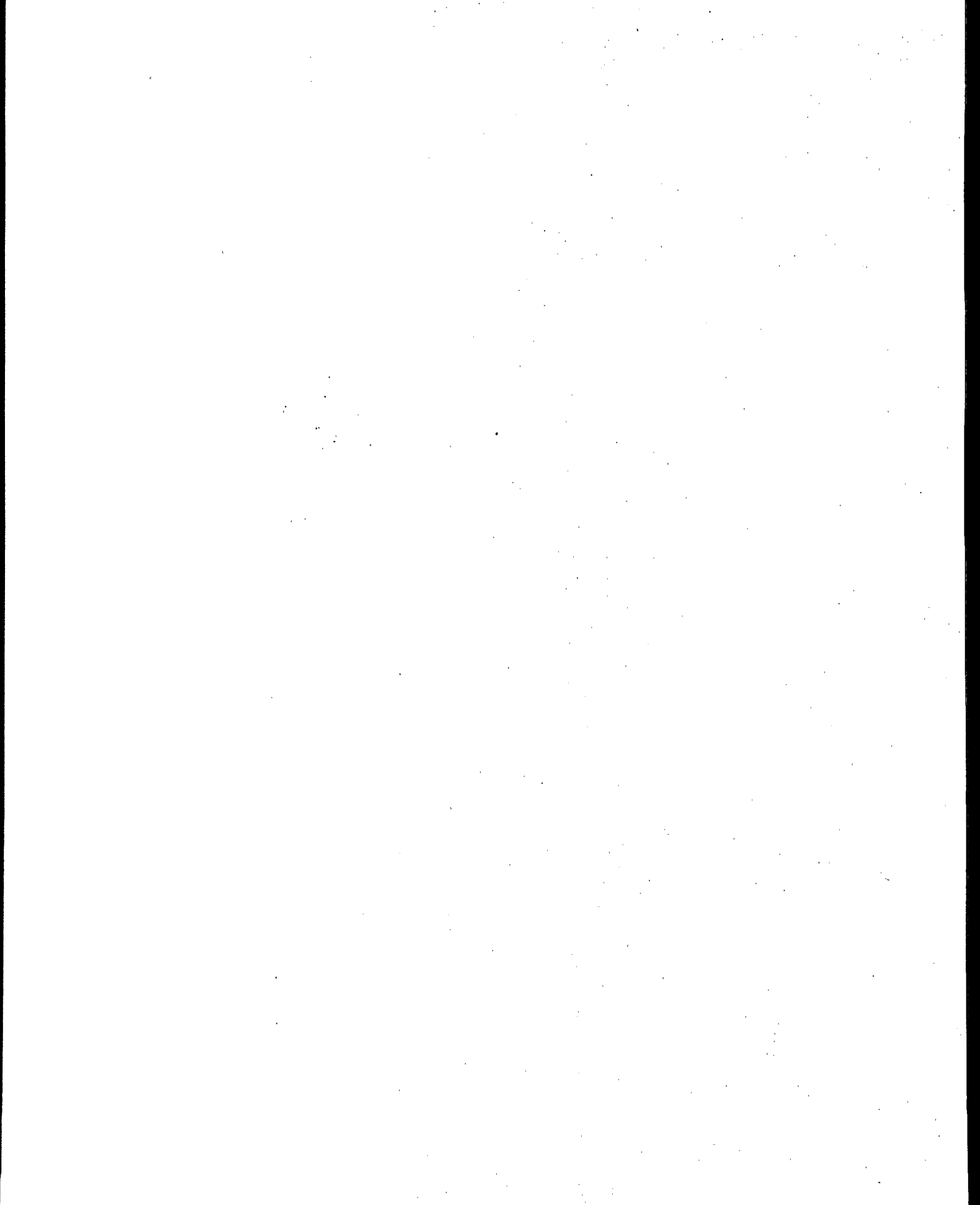

## APPENDIX B. NATIONAL IMPACTS ANALYSIS

This appendix presents the approach for estimating the national impacts of implementing reasonably available control technology (RACT) for wastewater streams generated by facilities within the six industrial categories discussed in Chapter 2.0.

Section B.1 details the development of model wastewater streams for the six industries, including the methodology for calculating total volatile organic (VO) concentration and average strippability ( $f_{avg}$ ) factors used (along with flow rate) to define the model wastewater stream, from individual compound information. Because in some cases these initial model wastewater streams represent the combined streams leaving the process unit, and not the individual wastewater streams at their point of generation, a methodology for disaggregating the combined streams into individual streams was developed. Section B.2 details this approach for disaggregating combined streams into individual wastewater streams. Sections B.3 and B.4 present the methodology (including sample calculations) for estimating uncontrolled volatile organic compound (VOC) emissions and emission reductions with control, and cost and secondary impacts of control. Finally, Section B.5 presents the national impacts of applying RACT to each of the individual industries.

### B.1 MODEL WASTEWATER STREAMS

As discussed in Chapter 2.0, model wastewater streams were developed from a variety of sources to represent the six industries included in this document. The information provided by the sources typically consisted of flow and speciated VOC concentration data. From these data, along with Henry's Law

constants for the individual VOC's, model wastewater streams were developed, with the following parameters: flow rate, total VO concentration, and strippability [fraction removed by steam stripping (fr)]. VO concentrations were calculated from VOC concentrations using the following formula:

$$VO = \Sigma (VOC_i * fm_i)$$

where:

- VO = volatile organic concentration as measured by EPA Method 25D;
- VOC<sub>i</sub> = total concentration of volatile organic compound i; and
- fm<sub>i</sub> = the fraction of the total volatile organic compound i measured by EPA Method 25D, predicted for compounds of interest using a theoretical analysis.

In estimating the potential VOC removal efficiency (fr<sub>i</sub>) for individual compounds in the wastewater stream, the predicted efficiency of the design steam stripper was used. The efficiency was first predicted on an individual compound basis (as discussed in Section 4.2), and then the average fractional reduction in emission potential (fr<sub>avg</sub>) due to steam stripping was calculated for each model wastewater stream using the following equation:

$$fr_{avg} = \frac{\Sigma_i (VOC_i * fe_i * fr_i)}{\Sigma_i VOC_i * fe_i}$$

where:

- fr<sub>avg</sub> = the average fraction of the total VO removed from the wastewater due to steam stripping, or the fractional reduction in emission potential;
- VOC<sub>i</sub> (mg/l) = the VOC concentration of compound i;
- fe<sub>i</sub> = the fraction of compound i emitted into the atmosphere; and

$fr_i$  = the fraction of compound  $i$  removed by steam stripping from a wastewater stream.

Table B-1 presents an example calculation of the total VO concentration and the average  $fr$  for a model wastewater stream. The development of model wastewater streams for the six industries discussed in this document is presented in the following sections.

#### B.1.1 Organic Chemicals, Plastics, and Synthetic Fibers Industry

Table B-2 presents a summary of the Organic Chemicals, Plastics, and Synthetic Fibers (OCPSF) model wastewater streams. The basis for the development of these model wastewater streams is the wastewater stream data reported by facilities in the synthetic organic chemical manufacturing industry (SOCMI) in response to a 1990 Section 114 Survey. The data reported were for individual streams at the point of generation and included individual organic compound concentration data and wastewater flow rates. The fraction removed ( $fr$ ) was calculated for the entire SOCMI 114 data base using the VO loading weighted average  $fr$  as described in Section B.1. The resulting  $fr$  was 0.93. This number describes the steam strippers effectiveness to remove the organic compounds present in the 114 data base. Additional description of the basis is presented in Section 2.1. The wastewater stream total VO concentrations and average  $fr$ 's were calculated as detailed in the example in Table B-1.

#### B.1.2 Pesticides Manufacturing Industry

Table B-3 summarizes the pesticides manufacturing industry model wastewater streams. The basis for the development of these model wastewater streams is the wastewater stream data reported by facilities in response to a 1989 Section 308 survey by the Office of Water Regulations and Standards (OWRS). Data reported in the survey responses included flow rates and individual organic compound concentrations. Additional description of the basis is presented in Section 2.2. The data were reported for combined process unit effluent streams and

TABLE B-1. EXAMPLE WASTEWATER STREAM DEVELOPMENT

Plant ID	Stream ID	Flow (lpm)	Compound	VOC conc. (mg/l)	fm <sup>a</sup>	VO conc. <sup>b</sup> (mg/l)	fe	fr <sup>c,d</sup>
A	1	10	Chloroform	13	1.0	13	0.69	1.0
			Isopropanol	1,170	0.793	930	0.48	0.89
			Methanol	170	0.321	55	0.22	0.97
			Acetone	1,340	0.829	1,110	0.37	0.94
Wastewater stream total/composite				2,693		2,108		0.92

<sup>a</sup>  $f_{m_i}$  = the fraction of the total volatile organic compound  $i$  measured by EPA Method 25D, predicted for compounds of interest using a theoretical analysis.<sup>1</sup>

<sup>b</sup> Volatile organic concentration = VOC concentration \*  $f_m$

<sup>c</sup> Individual compound,  $f_{r_i}$  = the fraction of compound  $i$  removed from the wastewater due to steam stripping.

<sup>d</sup>  $F_{r_{avg}}$  = the average fraction of the total VO removed from the wastewater due to steam stripping, or the fractional reduction in emission potential.

$$f_{r_{avg}} = \frac{\sum_i (VOC_i * f_{e_i} * f_{r_i})}{\sum_i VOC_i * f_{e_i}} = \frac{1,011}{1,104} = 0.92$$



TABLE B-2. MODEL STREAMS: ORGANIC CHEMICALS, PLASTICS, AND SYNTHETIC FIBERS MANUFACTURING INDUSTRY

Stream ID	Flow (lpm)	Total VO concentration (ppmw)	Fraction removed by steam stripper (fr)
1 1 2 1	11.36	521	0.956
1 1 2 2	0.05	38,500	0.160
1 1 3 1	0.34	3,198	0.878
1 1 3 2	0.59	777	0.649
1 1 3 3	98.41	213	0.303
1 1 4 1	158.97	213	0.303
1 1 4 2	0.05	821,800	0.944
1 1 6 1	2.08	242,781	0.951
1 1 6 2	0.22	556	0.770
1 1 6 3	25.21	160	0.820
1 1 6 4	66.24	6,021	0.818
1 1 6 5	0.05	63	0.815
1 112 1	6.13	8,227	0.617
1 112 2	6.13	871	0.930
1 112 3	8.63	7,629	0.921
1 112 4	8.63	6,973	0.922
1 112 5	7.91	893	0.915
1 3 1 1	5.37	0	0.000
1 3 1 2	2.16	0	0.580
1 3 1 3	0.22	0	0.000
1 3 1 4	66.24	5	0.588
1 3 1 5	2.08	5	0.000
1 3 1 6	11.36	5	0.000
1 3 1 7	11.36	49	1.000
1 3 1 8	11.36	5	0.000
1 3 1 9	11.36	1,225	0.580
1 3 110	2.16	5	0.000
1 3 111	28.39	0	0.000
1 3 112	141.94	12	0.580
1 3 2 1	0.54	0	1.000
1 3 2 2	66.24	24,700	1.000
1 3 2 3	283.88	500	0.966
1 3 2 4	2.08	3,300	1.000
1 3 2 5	2.16	1,050	1.000
1 3 2 6	0.22	200	0.958
1 4 1 1	66.24	0	0.090
1 4 1 2	0.54	0	0.090
1 4 1 3	3.86	931	0.940
1 4 1 4	12.53	949	0.958
1 4 1 5	40.73	41	0.971
1 4 2 1	2.16	9	0.941
1 4 2 2	0.54	9	0.941
1 4 2 3	5.79	42	0.976
1 4 2 4	0.22	23,511	0.956
1 4 2 5	0.05	32,596	0.928
1 4 2 6	25.93	18	0.655

TABLE B-2. MODEL STREAMS: ORGANIC CHEMICALS, PLASTICS, AND SYNTHETIC FIBERS MANUFACTURING INDUSTRY (Continued)

Stream ID	Flow (lpm)	Total VO concentration (ppmw)	Fraction removed by steam stripper (fr)
1 4 2 7	12.94	9	0.144
1 4 2 8	12.94	9	0.144
1 4 2 9	0.54	48,022	0.374
1 4 3 1	67.94	193	0.997
1 4 3 2	36.71	32	0.839
1 4 3 3	0.22	850	0.697
1 4 3 4	0.54	26,163	0.953
1 4 3 5	5.45	10	0.947
1 4 3 6	2.16	10	0.947
1 4 3 7	18.13	45	0.978
1 4 3 8	2.16	7,516	0.996
1 4 3 9	2.16	803	1.000
1 4 4 1	66.24	26	0.813
1 4 4 2	66.24	66	0.926
1 4 4 3	66.24	66	0.926
1 4 4 4	0.05	81	0.737
1 4 5 1	66.24	12	0.700
1 4 5 2	66.24	20	0.700
1 4 6 1	889.48	2,363	0.988
1 4 6 2	28.39	1,215	0.980
1 4 6 3	1,135.50	740	1.000
1 4 6 5	141.94	2,136	0.978
1 4 6 6	208.18	1,567	0.986
1 4 6 7	28.39	4,813	0.984
1 4 6 8	0.22	500	1.000
1 4 6 9	2.16	500	1.000
1 4 6 10	2.16	4,000	0.998
1 4 8 1	11.36	1,000	1.000
1 4 8 2	11.36	1,000	1.000
1 4 11 1	193.04	115	0.991
1 4 11 2	378.50	230	0.980
1 4 11 3	66.24	296	0.980
1 4 11 4	2,668.43	72	0.980
1 4 11 5	66.24	8	0.980
1 4 11 6	66.24	5	0.980
1 4 11 7	2.16	26,545	0.980
1 4 11 8	11.36	5	0.980
1 4 11 9	141.94	64	0.980
1 4 11 10	2.16	100	1.000
1 4 11 11	0.22	100	1.000
1 4 11 12	141.94	825	0.981
1 4 11 13	141.94	2,498	0.946
1 4 11 14	28.39	420	0.981
1 4 11 15	28.39	47	0.986
1 4 11 16	2.08	100	1.000
1 4 12 1	0.05	55	0.949
1 4 12 2	0.22	54	0.965

TABLE B-2. MODEL STREAMS: ORGANIC CHEMICALS, PLASTICS, AND SYNTHETIC FIBERS MANUFACTURING INDUSTRY (Continued)

Stream ID	Flow (lpm)	Total VO concentration (ppmw)	Fraction removed by steam stripper (fr)
1 412 3	0.05	55	0.949
1 412 4	0.54	54	0.965
1 412 5	0.01	55	0.949
1 412 6	0.22	54	0.965
1 412 7	0.03	55	0.949
1 412 8	0.22	54	0.965
1 412 9	2.16	55	0.949
1 413 1	283.88	1,126	0.940
1 413 2	28.39	196	0.580
1 413 3	141.94	678	0.000
1 413 4	0.22	1,128	0.940
1 413 5	0.54	0	0.000
1 413 6	2.16	1,129	0.000
1 413 7	2.16	1,129	0.000
1 413 8	0.54	1,129	0.000
1 413 9	66.24	1,092	0.580
1 41312	141.94	1,780	0.000
1 41313	0.22	1,129	0.000
1 41314	0.22	1,129	0.000
1 417 1	0.04	4,070	0.930
1 417 2	2.16	9	0.951
1 417 3	2.16	9	0.951
1 417 4	0.22	9	0.951
1 417 5	0.05	42,123	0.931
1 417 6	14.19	9	0.951
1 417 7	0.00	4,070	0.930
1 418 1	0.54	5,386	0.925
1 418 2	99.85	6	0.968
1 418 3	50.57	4	0.980
1 418 4	33.69	4	0.980
1 418 5	50.57	4	0.980
1 418 6	2.16	18,788	0.950
1 418 7	26.76	8	0.901
1 418 8	7.42	8	0.901
1 418 9	89.25	10	0.864
1 41810	3.71	8,069	0.929
1 419 1	0.05	8,202	0.930
1 419 2	36.07	8	0.943
1 419 3	36.07	11	0.747
1 419 4	3.60	11	0.747
1 419 5	0.05	89,181	0.931
1 419 6	17.52	8	0.953
1 419 7	0.54	8,202	0.930
1 420 1	0.22	23,805	0.996
1 420 2	95.91	30	0.904
1 420 3	38.38	6	0.986
1 420 4	2.16	4	0.980

TABLE B-2. MODEL STREAMS: ORGANIC CHEMICALS, PLASTICS, AND SYNTHETIC FIBERS MANUFACTURING INDUSTRY (Continued)

Stream ID	Flow (lpm)	Total VO concentration (ppmw)	Fraction removed by steam stripper (fr)
1 420 5	0.05	48,976	0.999
1 420 6	53.63	13	0.960
1 420 7	2.16	12,064	0.998
1 5 1 3	177.90	76	0.931
1 5 1 4	94.63	96	0.915
1 5 1 5	94.63	96	0.915
1 5 1 6	291.45	80	0.928
1 5 1 7	3.79	1,093	0.930
1 5 2 1	473.13	32	0.590
1 5 3 1	548.83	2,278	0.685
1 5 3 2	416.35	173	0.972
1 5 3 3	70.02	4,109	0.800
1 5 4 3	132.48	1,101	0.927
1 5 4 4	37.85	1,828	0.789
1 5 4 5	3.79	1,828	0.789
1 5 4 7	18.93	1,094	0.930
1 6 1 1	2.08	370	0.800
1 6 2 1	106.74	0	0.000
1 6 2 2	5.30	0	0.000
1 6 2 3	101.44	9	0.984
1 6 3 1	113.55	7,631	0.968
1 6 3 2	52.99	5,793	0.591
1 6 3 3	719.15	131	0.590
1 6 3 4	1.66	22,612	0.864
1 6 3 5	0.35	23,762	0.871
1 6 3 6	0.09	9,652	0.952
1 6 3 7	0.20	24	0.590
1 6 3 8	0.92	0	0.000
1 7 1 1	0.32	8	0.940
1 7 1 2	0.58	31,095	0.883
2 2 4 1	264.95	22	0.894
2 2 4 2	18.93	34	0.980
2 2 4 3	18.93	34	0.980
2 2 5 1	11.36	441	0.950
2 2 5 2	11.36	8,810	0.950
2 2 5 3	28.39	441	0.950
2 210 1	66.24	1	0.800
2 210 2	66.24	1	0.800
2 210 3	66.24	40	1.000
2 210 4	2.08	20	1.000
2 210 5	2.08	20	1.000
2 210 6	2.08	20	1.000
2 210 7	2.08	20	1.000
2 210 8	2.08	20	1.000
2 212 1	66.24	800	0.905
2 212 2	11.36	6,398	0.985
2 213 1	5.37	0	0.000

TABLE B-2. MODEL STREAMS: ORGANIC CHEMICALS, PLASTICS, AND SYNTHETIC FIBERS MANUFACTURING INDUSTRY (Continued)

Stream ID	Flow (lpm)	Total VO concentration (ppmw)	Fraction removed by steam stripper (fr)
2 214 1	2.08	3,695	0.800
2 214 2	28.39	4	0.800
3 1 1 1	11.36	4	0.980
3 1 1 2	66.24	4	0.980
3 1 1 3	66.24	17	0.980
3 1 2 1	0.54	158	0.000
3 1 2 2	0.54	1,190	0.980
3 1 2 3	0.54	307	0.920
3 1 3 1	2.16	589	0.980
3 1 3 2	2.16	462	0.950
3 1 3 3	2.16	425	0.980
3 1 4 1	66.24	3,678	0.000
3 1 4 2	66.24	28,900	0.980
3 1 4 3	66.24	1,317	0.950
3 1 5 1	66.24	2,550	0.980
3 1 5 2	66.24	5,950	0.980
3 1 5 3	66.24	1,097	0.980
3 2 1 1	378.50	382	1.000
3 2 1 2	141.94	28	0.710
3 2 1 3	141.94	428	0.983
3 2 1 4	28.39	186	0.996
3 2 1 5	208.18	23,522	0.982
3 2 1 6	66.24	26	0.980
3 2 1 7	244.89	43	0.980
3 2 1 8	66.24	19	1.000
3 2 1 9	28.39	511	0.840
3 2 110	3.60	17,030	0.840
3 2 2 1	11.36	10,575	0.985
3 3 1 1	1.26	6	0.541
3 3 1 2	2.90	8	0.553
3 3 1 3	306.59	19	0.503
3 3 3 1	5.37	0	0.000
3 3 3 2	2.08	642	0.590
3 3 4 1	1.26	6	0.541
3 3 4 2	2.90	8	0.553
3 3 4 3	306.59	19	0.503
3 3 7 1	11.36	0	1.000
3 3 7 2	11.36	2	1.000
3 3 8 1	28.39	10,660	0.950
3 3 8 2	11.36	0	0.000
3 310 1	11.36	2,050	0.950
3 310 2	11.36	9,246	0.952
3 310 3	11.36	2,162	0.959
3 311 1	264.95	1,287	0.849
3 311 2	28.39	4,000	1.000
3 311 3	66.24	800	1.000

TABLE B-2. MODEL STREAMS: ORGANIC CHEMICALS, PLASTICS, AND SYNTHETIC FIBERS MANUFACTURING INDUSTRY (Continued)

Stream ID	Flow (lpm)	Total VO concentration (ppmw)	Fraction removed by steam stripper (fr)
4 1 3 3	11.36	7	0.980
4 1 3 4	719.15	0	1.000
4 1 4 1	66.24	7,217	0.781
4 1 4 2	11.36	3,232	0.947
4 1 5 1	141.94	251	0.991
4 1 5 2	66.24	35	0.963
4 1 5 3	66.24	11	0.987
4 113 1	7.57	14,741	0.966
4 114 0	5.37	0	0.000
4 115 1	11.36	7,655	0.512
4 116 1	66.24	1,275	0.960
4 116 2	283.88	62	0.940
4 116 3	141.94	62	0.940
4 116 4	0.22	12,460	0.940
4 116 5	11.36	1,246	0.940
4 116 6	28.39	158	0.976
4 2 1 1	66.24	1,700	0.980
4 2 1 2	66.24	682	0.979
4 2 1 3	227.10	120	0.964
4 2 1 4	11.36	3,400	0.980
4 2 1 5	2.08	671,700	0.941
4 2 1 6	11.36	0	0.000
4 2 1 7	11.36	0	0.000
4 2 1 8	11.36	2,550	0.980
4 2 1 9	11.36	663	0.940
4 2 110	11.36	3,754	0.949
4 2 111	2.08	17	0.980
4 2 112	28.39	572	0.950
4 2 113	7.95	25	0.960
4 2 2 1	20.82	1,328	0.570
4 2 2 2	454.20	229	0.583
4 2 2 3	37.85	1,516	0.960
4 2 3 1	141.94	1,284	0.590
4 2 4 1	28.39	14,310	0.950
4 2 5 1	19.45	414	0.905
4 2 5 2	0.23	486	0.343
4 2 5 3	3.07	25,415	0.980
4 2 5 4	0.32	7,900	0.000
4 2 6 1	46.82	0	0.000
4 2 6 2	0.11	206	0.520
4 2 6 3	3.13	4,743	0.529
4 2 6 4	46.82	0	0.000
4 2 7 1	0.54	1,497	0.395
4 2 7 2	11.36	6,035	0.980
4 2 7 3	66.24	364	0.458
4 2 8 1	66.24	2,170	1.000
4 2 8 2	11.36	434	1.000

TABLE B-2. MODEL STREAMS: ORGANIC CHEMICALS, PLASTICS, AND SYNTHETIC FIBERS MANUFACTURING INDUSTRY (Continued)

Stream ID	Flow (lpm)	Total VO concentration (ppmw)	Fraction removed by steam stripper (fr)
4 2 8 3	2.08	4,340	1.000
5 1 2 1	28.39	300	1.000
5 1 2 2	283.88	0	0.000
5 1 4 1	8.71	108	0.992
5 1 4 2	66.24	359	0.982
5 1 4 3	283.88	348	0.970
5 1 4 5	19.45	82	0.976
5 1 4 6	66.24	184	0.962
5 1 4 7	141.94	28	0.975
5 1 4 8	141.94	75	0.977
5 1 410	11.36	7,093	1.000
5 1 411	28.39	323	0.998
5 1 412	141.94	48	0.994
5 1 413	283.88	0	0.980
5 1 414	283.88	0	0.000
5 1 415	66.24	50	0.993
5 1 416	11.36	2	0.981
5 2 1 1	18.13	895	0.933
5 2 1 2	34.56	109	0.933
5 2 1 3	2.88	533	0.950
5 2 1 5	0.36	8,540	0.815
5 2 2 1	8.71	43,335	0.590
5 2 2 2	0.11	31,137	0.590
5 2 2 3	0.19	27,092	0.590
5 2 2 4	0.05	160,500	0.590
5 3 1 1	227.10	8,212	0.913
5 4 1 1	2.08	0	1.000
5 4 1 2	5.37	0	1.000
5 4 1 3	0.00	0	1.000
5 4 1 4	11.36	0	1.000
5 4 1 5	0.22	0	1.000
5 4 1 6	0.05	0	1.000
5 4 2 1	11.36	33	1.000
5 4 4 1	0.05	300	1.000
5 4 4 2	141.94	803	1.000
5 4 4 3	2.08	241	1.000
5 4 4 4	66.24	241	1.000
5 4 4 5	5.37	24	1.000
5 4 4 6	5.37	241	1.000
5 5 3 1	283.88	8,491	0.979
5 5 3 2	283.88	8,475	0.980
5 5 4 1	141.94	10,186	0.980
5 5 4 2	283.88	3,970	0.977
5 6 1 1	141.94	80	1.000
5 6 1 2	28.39	100	0.995
5 6 1 3	60.56	1,750	0.995
5 6 1 4	189.25	1,000	1.000

TABLE B-2. MODEL STREAMS: ORGANIC CHEMICALS, PLASTICS, AND SYNTHETIC FIBERS MANUFACTURING INDUSTRY (Continued)

Stream ID	Flow (lpm)	Total VO concentration (ppmw)	Fraction removed by steam stripper (fr)
5 7 2 1	408.78	0	1.000
6 1 1 1	0.22	2,460	1.000
6 1 1 2	66.24	521	0.747
6 1 1 3	0.54	4,045	1.000
6 1 1 4	2.08	1,350	1.000
6 1 1 5	0.54	285	1.000
6 1 1 6	0.22	110	1.000
6 1 1 7	0.05	100	1.000
6 1 2 1	1.04	100	1.000
6 1 2 2	2.16	105	1.000
6 1 2 3	0.22	3,000	1.000
6 1 2 4	2.16	23	0.981
6 1 2 5	2.08	2,485	1.000
6 1 2 6	0.22	70	1.000
6 1 2 7	0.22	24	1.000
6 1 2 8	2.16	310	1.000
6 1 4 1	141.94	161	0.882
6 1 4 2	2.16	332	0.618
6 1 4 3	2.16	7,870	0.605
6 1 4 4	2.16	5,683	0.717
6 1 4 5	0.54	446	0.699
6 1 4 6	5.76	83	0.637
7 1 1 1	9.16	28	0.984
7 1 1 2	11.36	16	0.993
7 1 1 3	11.36	85	0.980
7 1 1 4	2.16	13,406	0.985
7 1 1 5	0.22	21	0.982
7 1 1 6	11.36	85	0.980
7 1 1 7	0.54	28	0.988
7 1 1 8	530.01	54	0.986
7 1 1 9	28.39	85	0.980
7 1 110	141.94	85	0.980
7 1 111	28.39	85	0.980
7 1 112	66.24	85	0.980
7 1 113	0.05	17,030	0.980
7 1 114	28.39	0	0.000
7 1 115	0.54	3	1.000
7 1 2 1	62.45	11,514	1.000
7 1 2 2	62.45	0	1.000
7 1 2 3	12.49	0	1.000
7 1 2 4	7.95	0	1.000
7 1 2 5	2.46	0	1.000
7 1 2 6	105.98	0	1.000
7 1 2 7	7.95	0	1.000
7 1 2 8	4.43	6	1.000
7 1 2 9	0.95	0	1.000
7 1 212	2.08	13	1.000



TABLE B-2. MODEL STREAMS: ORGANIC CHEMICALS, PLASTICS, AND SYNTHETIC FIBERS MANUFACTURING INDUSTRY (Continued)

Stream ID	Flow (lpm)	Total VO concentration (ppmw)	Fraction removed by steam stripper (fr)
7 1 214	62.45	85	0.998
7 1 215	180.17	0	0.000
7 1 3 4	10.22	0	1.000
7 1 3 6	140.05	0	1.000
7 1 3 7	10.22	0	1.000
7 1 3 8	5.87	6	1.000
7 1 310	0.19	1,865	1.000
7 1 311	0.19	36	1.000
7 1 312	0.19	56	1.000
7 1 313	5.44	604	1.000
7 1 315	238.08	0	0.000
7 1 316	141.94	85	0.998
7 1 4 1	79.49	11,514	1.000
7 1 4 2	79.49	0	1.000
7 1 4 3	15.90	0	1.000
7 1 4 4	9.84	0	1.000
7 1 4 5	3.14	0	1.000
7 1 4 6	132.48	0	1.000
7 1 4 7	9.84	0	1.000
7 1 4 8	5.53	6	1.000
7 1 4 9	1.21	0	1.000
7 1 414	79.49	85	0.998
7 1 415	225.21	0	0.000
7 1 6 1	3.97	27	0.980
7 1 6 2	2.16	0	0.995
7 1 6 3	5.26	14	0.984
7 1 6 4	0.22	0	1.000
7 1 6 5	2.16	2	0.989
7 1 6 6	7.34	147	0.980
7 1 6 7	2.16	680,003	0.980
7 1 6 8	23.81	88	0.981
7 1 6 9	6.81	1	0.991
7 1 610	8.06	1	0.998
7 1 611	2.16	1	0.980
7 1 612	2.16	0	0.980
8 1 1 1	0.54	0	1.000
8 1 1 2	0.54	0	1.000
8 1 2 1	28.39	0	1.000
8 1 2 2	28.39	15	1.000
8 3 1 1	141.94	4	0.990
8 3 1 2	66.24	0	1.000
8 3 1 3	5.37	4	0.990
8 3 1 4	205.90	1	0.983
8 3 4 1	28.39	30	0.004
8 3 4 2	11.36	137	0.967
8 3 5 1	66.24	0	0.000
8 3 5 2	283.88	0	0.000

TABLE B-2. MODEL STREAMS: ORGANIC CHEMICALS, PLASTICS, AND SYNTHETIC FIBERS MANUFACTURING INDUSTRY (Concluded)

Stream ID	Flow (lpm)	Total VO concentration (ppmw)	Fraction removed by steam stripper (fr)
8 3 5 3	283.88	0	0.000
8 3 5 4	2.16	0	0.000
8 3 5 5	283.88	0	0.000
8 3 8 1	283.88	927	0.999
8 3 8 2	3.71	810	1.000
8 3 8 3	141.94	453	1.000
8 3 8 4	5.45	451	1.000
8 3 8 5	37.32	2,667	1.000
8 3 8 6	9.31	451	1.000
8 3 8 7	3.71	451	1.000
8 3 8 8	11.24	451	1.000
8 3 8 9	66.24	104	1.000
8 3 810	28.39	2,100	1.000
8 3 811	3.71	96	1.000
8 3 9 1	75.70	8	0.590
8 3 9 2	757.00	3	1.000
8 3 9 3	113.55	32	0.590
8 310 1	2.16	1	0.090
8 312 1	66.24	0	0.000
8 312 2	28.39	145	0.960
8 312 3	0.22	0	0.000
8 312 4	0.22	0	0.000
9 1 1 1	0.22	0	1.000
9 1 2 1	0.22	20	1.000
9 1 2 2	2.16	16,610	0.940
9 1 2 3	0.22	20	1.000
9 1 2 4	0.22	20	1.000
9 1 2 5	283.88	16,610	0.940
9 1 2 6	0.22	16,610	0.940
9 1 3 1	10.98	0	0.998
9 1 3 2	0.22	17	0.992
9 1 3 3	66.24	0	1.000
9 1 3 4	7.57	1	0.993
9 1 3 5	264.95	1	1.000
9 1 3 6	2.16	0	1.000
9 1 3 7	2.16	0	1.000
9 1 3 8	11.36	0	1.000
9 1 3 9	11.36	0	1.000
9 1 310	0.22	0	1.000
9 2 1 1	279.26	1	1.000

TABLE B-3. MODEL STREAMS: PESTICIDES MANUFACTURING INDUSTRY

Plant ID	Process ID	Stream ID	Flow (lpm)	Total VO concentration (ppmw)	Fraction removed by steam stripper (fr)
A	1	1	18.3	50.1	1.00
A	1	2	14.6	843	1.00
A	1	3	3.65	6,010	1.00
B	1	1	2.90	13.0	0.89
C	1	1	0.825	1,180	1.00
C	1	2	7.23	0.99	1.00
C	1	3	5.78	16.7	1.00
C	1	4	1.45	119	1.00
C	1	5	4.21	203	0.97
D	1	1	11.3	10.1	0.42
D	1	2	9.04	170	0.42
D	1	3	2.26	1,210	0.42
D	1	4	11.4	1,060	0.95
D	1	5	9.08	17,800	0.95
D	1	6	2.27	127,200	0.95
D	1	7	24.64	0.078	0.97
D	1	8	19.7	1.31	0.97
D	1	9	4.93	9.36	0.97
E	1	1	5.40	135	1.00
E	1	2	4.32	2,270	1.00
E	1	3	1.08	16,200	1.00
E	1	4	78.6	8.53	0.71
E	1	5	62.9	143	0.71
E	1	6	15.7	1,020	0.71
E	2	1	1.13	0.250	0.94
E	2	2	4.00	4.00	0.94
F	1	1	28.4	278	0.97
F	1	2	22.7	4,670	0.97
F	1	3	5.68	33,300	0.97
F	2	1	8.62	356	0.40
F	2	2	6.89	6,000	0.40
F	2	3	1.72	42,800	0.40
F	3	1	12.4	21.7	0.98
F	3	2	9.92	1,020	0.98
F	3	3	2.48	2,600	0.98
F	4	1	10.3	60.4	0.31
F	4	2	8.24	1,020	0.31
F	4	3	2.06	7,240	0.31
G	1	1	67.6	19.9	0.90
G	1	2	54.1	334	0.90
G	1	3	13.5	2,380	0.90
G	2	1	89.5	60.1	0.95
G	2	2	71.6	1,010	0.95
G	2	3	17.9	7,210	0.95

TABLE B-3. MODEL STREAMS: PESTICIDES MANUFACTURING INDUSTRY  
(Concluded)

Plant ID	Process ID	Stream ID	Flow (lpm)	Total VO concentration (ppmw)	Fraction removed by steam stripper (fr)
H	1	1	32.4	2.70	0.99
H	1	2	25.9	45.5	0.99
H	1	3	6.48	324	0.99
H	1	4	10.6	1.66	0.07
H	1	5	8.49	28.0	0.07
H	1	6	2.12	200	0.07
I	1	1	301	15.1	1.00
I	1	2	241	254	1.00
I	1	3	60.3	1,810	1.00
I	1	4	47.3	4.68	1.00
I	1	5	37.9	78.7	1.00
I	1	6	9.46	562	1.00
K	1	1	0.329	12.0	0.96
M	1	1	97.4	67.4	0.39
M	1	2	77.9	1,130	0.39
M	1	3	19.5	8,090	0.39
M	2	1	2.63	12.7	0.48
M	2	2	2.10	214	0.48
M	2	3	0.526	1,530	0.48
M	2	4	2.63	7.49	0.96
M	2	5	2.10	126	0.96
M	2	6	0.526	899	0.96
M	2	7	2.63	1.51	0.97
M	2	8	2.10	25.4	0.97
M	2	9	0.526	181	0.97
M	2	10	35.9	184	1.00
M	2	11	28.7	3,090	1.00
M	2	12	7.17	22,000	1.00
M	2	13	5.68	355	1.00
M	2	14	4.54	5,980	1.00
M	2	15	1.14	42,600	1.00

were disaggregated to produce individual wastewater stream data using the procedure discussed in Section B.2. The wastewater stream total VO concentrations and average fr's were calculated as detailed in the example in Table B-1.

#### B.1.3 Treatment, Storage, and Disposal Facilities Industry

Table B-4 summarizes the Treatment, Storage, and Disposal Facilities Industry (TSDF) model wastewater streams. The basis for the development of these model wastewater streams is the wastewater stream data reported by facilities in response to the 1986 Office of Solid Waste (OSW) Generator Survey under authority of Section 3007 of the Resource Conservation and Recovery Act (RCRA). Data reported in the survey responses included flow rates and individual organic compound concentrations. Additional description of the basis is presented in Section 2.5. The data were reported for combined process unit effluent streams and were disaggregated to produce individual wastewater stream data using the procedure discussed in Section B.2. The wastewater stream total VO concentrations and average fr's were calculated as detailed in the example in Table B-1.

#### B.1.4 Pharmaceutical Manufacturing Industry

Table B-5 summarizes the pharmaceutical manufacturing industry model wastewater streams. The basis for the development of these model wastewater streams is the wastewater stream data reported by facilities in response to a 1988 Section 308 survey by OWRS. Data reported in the survey responses included flow rates and individual organic compound concentrations. Additional description of the basis is presented in Section 2.4. The data were reported for combined process unit effluent streams and were disaggregated to produce individual wastewater stream data using the procedure discussed in Section B.2. The wastewater stream total VO concentrations and average fr's were calculated as detailed in the example in Table B-1.

#### B.1.5 Petroleum Refining Industry

The model streams representing the petroleum refining industry are based on the following:

TABLE B-4. MODEL STREAMS: TREATMENT, STORAGE,  
AND DISPOSAL FACILITIES

Model Stream No.	Flow (lpm)	Total VO concentration (ppmw)	Fraction removed by steam stripper (fr)
1	1,080	0.0484	0.65
2	861	0.814	0.65
3	215	5.80	0.65
4	861	0.814	0.65
5	688	13.7	0.65
6	172	97.7	0.65
7	430	112	0.65
8	861	0.814	0.65
9	688	13.70	0.65
10	172	97.70	0.65
11	688	13.70	0.65
12	551	230	0.65
13	138	1,640	0.65
14	344	1,880	0.65
15	430	112	0.65
16	344	1,880	0.65
17	86.1	13,400	0.65
18	13.9	8.35	0.59
19	11.1	140	0.59
20	2.77	1,000	0.59
21	0.170	500	1.00
22	0.790	500	1.00
23	1,200	0.0573	0.94
24	963	0.96	0.94
25	241	6.9	0.94
26	963	0.96	0.94
27	771	16	0.94
28	193	116	0.94
29	482	132	0.94

TABLE B-4. MODEL STREAMS: TREATMENT, STORAGE,  
AND DISPOSAL FACILITIES (Concluded)

Model Stream No.	Flow (lpm)	Total VO concentration (ppmw)	Fraction removed by steam stripper (fr)
30	963	0.963	0.94
31	771	16	0.94
32	193	116	0.94
33	771	16	0.94
34	617	273	0.94
35	154	1,950	0.94
36	385	2,220	0.94
37	482	132	0.94
38	385	2,220	0.94
39	96.3	15,900	0.94
40	18.1	5.21	0.99
41	14.5	88	0.99
42	3.62	625	0.99
43	106	438	0.82
44	84.6	7,360	0.82
45	21.2	52,500	0.82
46	1.40	100	1.00
47	241	1.48	0.09
48	192	24.9	0.09
49	48.1	178	0.09

TABLE B-5. MODEL STREAMS: PHARMACEUTICAL MANUFACTURING INDUSTRY

Manufacturing subcategory	Stream	Flow (lpm)	Total VO concentration (ppmw)	Fraction removed by steam stripper (fr)
A (Fermentation)	1	187	1.51	0.59
	2	149	25.4	0.59
	3	37.3	181	0.59
	4	456	46.4	0.84
	5	365	781	0.84
	6	91.1	5,570	0.84
	7	47.3	35.6	0.92
	8	37.9	599	0.92
	9	9.46	4,270	0.92
	10	255	21.8	0.93
	11	204	367	0.93
	12	51	2,620	0.93
	13	129	40.7	0.79
	14	103	685	0.79
	15	25.8	4,890	0.79
C (Chemical Synthesis)	1	248	75	0.91
	2	198	1,260	0.91
	3	49.6	9,000	0.91
	4	31.5	3.64	0.80
	5	25.2	61.2	0.80
	6	6.31	437	0.80
	7	1,240	15.3	0.82
	8	996	258	0.82
	9	249	1,840	0.82
	10	26.3	75.3	0.63
	11	21	1,270	0.63
	12	5.26	9,040	0.63



TABLE B-5. MODEL STREAMS: PHARMACEUTICAL MANUFACTURING INDUSTRY  
(Concluded)

Manufacturing subcategory	Stream	Flow (lpm)	Total VO concentration (ppmw)	Fraction removed by steam stripper (fr)
C (continued)	13	52.6	984	0.82
	14	42.1	16,600	0.82
	15	10.5	118,000	0.82
D (Formulation and Packaging)	1	26.3	10.4	0.93
	2	21	175	0.93
	3	5.26	1,250	0.93
	4	2.1	0.104	0.00
	5	1.68	1.75	0.00
	6	0.421	12.5	0.00
	7	4.86	110	0.93
	8	3.89	1,850	0.93
	9	0.973	13,200	0.93
	10	1.08	0.00936	0.92
	11	0.862	0.157	0.92
	12	0.216	1.12	0.92
	13	13.1	7.38	0.87
	14	10.5	124	0.87
	15	2.63	886	0.87

- Throughput capacities for process units identified in the petroleum refining industry, for the 190 refineries included in the 1990 Oil and Gas Journal Survey (Table B-6);<sup>2</sup>
- Wastewater generation factors for combined effluent wastewater streams from each process unit (Table B-7), taken from the "New Source Performance Standards (NSPS) Background Information Document (BID) for Petroleum Refining Wastewater Systems,"<sup>3</sup> and multiplied by process unit capacities to calculate process unit wastewater flow rates for each refinery; and
- Volatile organic concentrations for the combined effluent wastewater streams from each process unit, based on benzene concentration data presented in the NSPS BID for Petroleum Refining Wastewater Systems<sup>3</sup> and Benzene National Emissions Standards for Hazardous Air Pollutants (NESHAP) Impacts Document.<sup>4</sup>

Table B-8 summarizes the development and assignment of VO concentrations to each process unit. The catalytic hydrorefining and catalytic hydrocracking process units are assigned concentrations based on the solubilities of compounds expected to be present. Each of the other process units is assigned a benzene, toluene, xylene, and non-BTX (benzene, toluene, xylene) concentration.

Benzene concentrations were assigned from the linear average of the ranges of benzene concentrations reported in the Benzene NESHAP Impacts Document.<sup>4</sup> Toluene and xylene concentrations were assigned, based on the benzene concentrations, using scaling factors developed from liquid and gas phase concentration data for samples taken at air flotation devices in petroleum refineries.<sup>5</sup> These scaling factors are:

$$\begin{aligned}
 f_{\text{Benzene}} &= 143 \text{ ppmw;} \\
 f_{\text{Toluene}} &= 168 \text{ ppmw;} \text{ and} \\
 f_{\text{Xylene}} &= 83 \text{ ppmw.}
 \end{aligned}$$

TABLE B-6. PETROLEUM REFINERY PROCESS UNIT CAPACITY DATA BASE  
(barrels/day)

Facility	Crude <sup>a</sup> storage	Crude <sup>a</sup> desalting	Atmospheric <sup>a</sup> distillation	Vacuum distil- lation	Vis- breaking	Coking	Catalytic cracking	Catalytic reforming	Distillate upgrading	Catalytic hydro- refining	Naphtha Hydrodesul- furization	Asphalt	Catalytic hydro- cracking
1	14,250	14,250	14,250	14,000	0	0	0	0	0	0	0	10,000	0
2	45,000	45,000	45,000	15,000	0	12,000	0	6,000	0	14,800	7,500	9,500	0
3	80,000	80,000	80,000	20,000	0	0	0	20,000	0	15,000	20,000	0	0
4	12,000	12,000	12,000	0	0	0	0	0	0	0	0	0	0
5	16,000	16,000	16,000	0	0	0	0	0	0	0	0	0	0
6	22,000	22,000	22,000	0	0	0	0	0	0	0	0	6,000	0
7	102,000	102,000	102,000	6,000	0	0	0	0	0	0	0	2,000	0
8	7,000	7,000	7,000	0	0	0	0	0	0	0	0	0	0
9	72,000	72,000	72,000	0	0	0	0	12,000	0	0	12,000	0	9,000
10	5,710	5,710	5,710	2,000	0	0	0	0	0	0	0	1,000	0
11	8,000	8,000	8,000	6,000	0	0	0	0	0	0	0	0	0
12	3,800	3,800	3,800	1,500	0	0	0	0	0	0	0	1,000	0
13	6,770	6,770	6,770	4,000	0	0	0	0	0	0	0	2,200	0
14	48,000	48,000	48,000	25,000	0	0	19,275	9,000	0	0	15,500	6,500	0
15	10,000	10,000	10,000	7,000	0	0	0	0	0	0	0	7,000	0
16	220,000	220,000	220,000	112,000	0	56,000	82,000	48,000	22,000	0	76,000	0	0
17	14,200	14,200	14,200	0	0	0	0	0	0	0	0	0	0
18	286,000	286,000	286,000	114,000	0	54,000	62,000	51,000	45,000	98,000	70,000	0	0
19	270,000	270,000	270,000	175,000	0	0	63,000	50,000	45,000	125,000	66,000	11,000	60,500
20	9,500	9,500	9,500	7,800	0	0	0	0	0	0	0	6,800	0
21	41,600	41,600	41,600	21,165	0	0	0	0	0	0	0	15,554	0
22	128,000	128,000	128,000	67,000	0	27,500	75,000	32,000	32,000	37,000	74,000	0	0
23	26,500	26,500	26,500	17,000	0	0	12,000	5,000	0	12,000	5,000	0	0
24	10,348	10,348	10,348	10,230	0	0	0	0	0	0	0	4,000	0
25	40,600	40,600	40,600	25,000	13,800	0	13,500	19,000	11,000	0	12,000	4,000	0





TABLE B-6. PETROLEUM REFINERY PROCESS UNIT CAPACITY DATA BASE  
(barrels/day) (Continued)

Facility	Crude <sup>a</sup> storage	Crude <sup>a</sup> desalting	Atmospheric <sup>a</sup> distillation	Vacuum distillation	Vis-breaking	Coking	Catalytic cracking	Catalytic reforming	Distillate upgrading	Catalytic hydro-refining	Naphtha Hydrodesulfurization	Asphalt	Catalytic hydro-cracking
76	9,865	9,865	9,865	0	0	0	0	1,900	0	0	0	0	0
77	320,000	320,000	320,000	83,000	0	63,000	150,000	91,000	37,000	40,000	105,000	0	0
78	159,500	159,500	159,500	63,000	0	60,000	42,500	28,000	0	0	141,000	0	0
79	421,000	421,000	421,000	183,000	0	90,000	188,000	90,000	24,000	0	152,500	28,900	0
80	62,300	62,300	62,300	24,000	0	0	30,000	12,500	0	0	12,500	0	0
81	40,000	40,000	40,000	20,000	0	0	0	0	0	0	0	0	0
82	7,800	7,800	7,800	0	0	0	0	0	0	0	0	0	0
83	255,000	255,000	255,000	125,000	0	0	90,000	48,000	0	109,000	48,000	25,000	0
84	160,000	160,000	160,000	92,500	0	33,000	55,000	47,000	18,000	43,000	69,000	0	0
85	92,500	92,500	92,500	40,000	0	0	37,500	23,000	0	15,000	29,000	0	0
86	47,000	47,000	47,000	18,000	0	0	20,500	10,000	0	0	10,000	0	0
87	215,000	215,000	215,000	78,000	0	21,000	0	56,000	35,000	70,000	57,000	0	0
88	194,750	194,750	194,750	73,000	0	21,000	91,300	37,500	0	0	88,000	0	0
89	225,000	225,000	225,000	75,000	12,000	0	90,000	40,000	0	0	142,000	0	35,000
90	4,000	4,000	4,000	0	0	0	0	0	0	0	0	0	0
91	5,600	5,600	5,600	0	0	0	0	1,000	0	0	0	0	0
92	68,500	68,500	68,500	30,000	0	0	28,300	18,500	0	16,000	21,000	10,000	0
93	45,600	45,600	45,600	0	0	0	19,500	14,000	0	5,800	23,000	0	0
94	67,100	67,100	67,100	32,000	0	0	23,000	23,500	0	23,000	31,700	14,000	0
95	218,500	218,500	218,500	160,000	0	58,000	56,000	32,000	0	63,500	87,000	35,000	0
96	30,000	30,000	30,000	20,000	0	8,000	16,000	5,800	0	0	11,800	0	0
97	295,000	295,000	295,000	243,000	0	62,000	58,000	90,000	68,000	189,000	48,000	20,000	0
98	16,800	16,800	16,800	15,600	0	0	0	0	0	5,000	0	12,000	0
99	5,800	5,800	5,800	0	0	0	0	0	0	0	0	3,500	0
100	11,000	11,000	11,000	0	0	0	0	0	0	0	0	5,100	0

TABLE B-6. PETROLEUM REFINERY PROCESS UNIT CAPACITY DATA BASE  
(barrels/day) (Continued)

Facility	Crude <sup>a</sup> storage	Crude <sup>a</sup> desalting	Atmospheric <sup>a</sup> distillation	Vacuum distil- lation	Vis- breaking	Coking	Catalytic cracking	Catalytic reforming	Distillate upgrading	Catalytic hydro- refining	Naphtha Hydrodesul- furization	Asphalt	Catalytic hydro- cracking
101	40,400	40,400	40,400	14,000	0	0	15,000	12,000	0	14,000	15,000	6,000	0
102	49,500	49,500	49,500	20,000	0	0	19,500	14,700	0	0	42,500	6,500	0
103	42,000	42,000	42,000	18,000	0	7,700	24,500	10,000	4,900	0	35,500	11,000	0
104	7,000	7,000	7,000	2,800	0	0	2,600	1,000	0	0	2,500	1,200	0
105	4,500	4,500	4,500	2,500	0	0	0	0	0	0	0	0	0
106	0	0	0	0	0	0	50,000	0	0	0	0	0	0
107	80,000	80,000	80,000	46,000	0	0	0	0	0	0	0	35,000	0
108	109,250	109,250	109,250	45,000	10,000	0	50,000	27,000	0	0	56,000	0	0
109	130,000	130,000	130,000	66,000	0	0	145,000	28,000	0	50,000	113,000	38,000	0
110	100,000	100,000	100,000	62,400	0	21,500	36,000	23,500	0	15,000	65,500	0	0
111	75,000	75,000	75,000	30,000	0	0	0	0	0	0	0	0	0
112	16,800	16,800	16,800	0	0	0	6,500	4,000	0	0	4,000	0	0
113	19,000	19,000	19,000	7,900	0	0	10,800	6,800	0	0	6,800	700	0
114	38,000	38,000	38,000	6,000	0	0	17,000	7,800	0	0	19,500	3,400	0
115	6,500	6,500	6,500	0	0	0	0	2,500	0	0	0	0	1,000
116	42,500	42,500	42,500	27,000	0	0	0	0	0	0	0	0	0
117	58,000	58,000	58,000	0	0	0	31,200	12,100	0	0	16,600	0	0
118	66,000	66,000	66,000	33,000	0	0	25,000	20,000	0	23,000	27,000	12,000	0
119	171,000	171,000	171,000	51,000	0	16,200	43,800	53,000	0	0	59,000	0	23,000
120	120,650	120,650	120,650	49,000	0	13,700	55,000	42,000	0	0	37,000	7,000	35,000
121	125,000	125,000	125,000	30,000	0	0	61,000	45,600	28,200	0	40,000	0	0
122	13,000	13,000	13,000	0	0	0	0	0	0	0	0	0	0
123	140,000	140,000	140,000	45,000	0	20,500	53,000	36,000	0	0	66,000	0	0
124	43,000	43,000	43,000	13,000	0	0	20,000	8,500	5,000	0	9,000	0	0
125	50,000	50,000	50,000	26,500	0	0	23,000	12,000	0	0	17,000	2,500	0

TABLE B-6. PETROLEUM REFINERY PROCESS UNIT CAPACITY DATA BASE  
(barrels/day) (Continued)

Facility	Crude <sup>a</sup> storage	Crude <sup>a</sup> desalting	Atmospheric <sup>a</sup> distillation	Vacuum distil- lation	Vis- breaking	Coking	Catalytic cracking	Catalytic reforming	Distillate upgrading	Catalytic hydro- refining	Naphtha Hydrodesul- furization	Asphalt	Catalytic hydro- cracking
126	85,000	85,000	85,000	29,000	0	0	30,840	24,000	0	0	24,000	4,600	0
127	60,500	60,500	60,500	32,000	0	0	23,500	14,000	0	21,000	20,000	6,000	0
128	15,000	15,000	15,000	16,000	0	0	0	0	0	0	0	11,500	0
129	175,000	175,000	175,000	80,000	0	0	58,300	34,000	0	0	64,000	0	0
130	8,200	8,200	8,200	0	0	0	0	3,300	0	0	0	0	0
131	15,700	15,700	15,700	6,500	0	0	0	5,820	0	0	6,500	0	0
132	6,500	6,500	6,500	2,680	0	0	0	2,100	0	0	2,900	0	0
133	171,000	171,000	171,000	75,000	0	0	51,600	48,000	0	50,000	108,000	0	21,000
134	165,000	165,000	165,000	46,000	0	0	87,000	39,600	0	0	81,700	0	0
135	125,000	125,000	125,000	83,000	0	0	29,000	50,000	0	0	104,000	35,000	30,000
136	64,600	64,600	64,600	27,000	0	0	20,200	16,000	0	0	26,000	8,000	0
137	60,000	60,000	60,000	12,000	0	0	30,000	10,000	0	0	31,000	3,500	0
138	415,000	415,000	415,000	195,000	0	37,000	238,000	160,000	60,000	85,000	210,000	0	60,000
139	135,000	135,000	135,000	80,000	0	32,000	70,000	52,000	0	95,000	54,000	0	0
140	66,000	66,000	66,000	54,000	0	0	22,000	25,000	0	19,000	25,000	5,500	0
141	329,000	329,000	329,000	163,200	0	34,000	116,000	67,100	0	0	205,100	0	0
142	90,250	90,250	90,250	53,000	11,000	12,000	18,500	28,500	10,000	0	50,000	0	0
143	100,000	100,000	100,000	40,000	0	12,500	56,000	36,000	0	10,000	26,000	0	0
144	110,000	110,000	110,000	47,000	0	0	45,000	29,000	0	0	33,000	5,000	20,000
145	50,000	50,000	50,000	20,000	0	0	20,000	11,000	0	0	11,000	0	0
146	26,000	26,000	26,000	0	0	4,400	10,800	6,700	0	0	6,700	0	0
147	426,000	426,000	426,000	219,000	0	28,000	185,000	123,000	19,000	110,000	350,500	7,000	0
148	55,000	55,000	55,000	24,000	0	0	22,000	20,000	0	6,000	43,000	7,000	0
149	110,000	110,000	110,000	50,000	0	0	36,000	34,000	0	31,000	68,000	2,000	0
150	66,000	66,000	66,000	28,000	0	0	50,000	13,500	0	0	37,000	5,000	0



TABLE B-6. PETROLEUM REFINERY PROCESS UNIT CAPACITY DATA BASE  
(barrels/day) (Continued)

Facility	Crude <sup>a</sup> storage	Crude <sup>a</sup> desalting	Atmospheric <sup>a</sup> distillation	Vacuum distil- lation	Vis- breaking	Coking	Catalytic cracking	Catalytic reforming	Distillate upgrading	Catalytic hydro- refining	Naphtha Hydrodesul- furization	Asphalt	Catalytic hydro- cracking
151	123,000	123,000	123,000	64,000	21,000	0	50,000	23,000	0	0	52,000	0	0
152	2,900	2,900	2,900	0	0	0	0	1,200	0	0	0	0	0
153	125,000	125,000	125,000	42,000	0	12,000	40,800	48,500	0	0	57,500	0	0
154	49,500	49,500	49,500	16,000	0	6,000	17,850	16,200	0	0	20,800	0	0
155	10,000	10,000	10,000	0	0	0	0	0	0	0	0	0	0
156	265,000	265,000	265,000	129,000	0	40,000	90,000	110,000	0	129,000	163,000	0	0
157	69,500	69,500	69,500	27,000	0	0	39,000	10,000	0	0	0	0	0
158	275,000	275,000	275,000	86,000	0	29,500	102,000	103,000	32,000	0	208,000	0	0
159	105,000	105,000	105,000	0	0	0	70,400	26,000	0	90,000	26,500	0	0
160	175,000	175,000	175,000	83,000	0	0	99,000	36,000	0	125,000	53,000	0	0
161	44,100	44,100	44,100	12,000	0	0	0	0	0	0	0	0	0
162	215,900	215,900	215,900	88,000	0	0	70,000	63,000	65,000	45,000	172,500	7,400	0
163	28,600	28,600	28,600	10,000	0	0	10,500	10,000	0	0	11,000	0	0
164	104,000	104,000	104,000	36,000	0	0	50,000	30,000	0	18,000	67,000	0	0
165	250,000	250,000	250,000	143,100	0	0	141,500	42,000	15,000	0	122,000	14,000	0
166	27,000	27,000	27,000	15,000	10,000	0	0	0	0	0	0	0	0
167	120,000	120,000	120,000	43,000	0	0	43,000	32,000	0	0	53,600	2,500	0
168	25,000	25,000	25,000	24,000	0	0	67,700	0	0	61,000	0	0	0
169	40,000	40,000	40,000	0	0	0	22,000	7,600	0	0	7,600	0	0
170	24,000	24,000	24,000	3,800	0	0	6,000	5,000	0	0	6,000	0	0
171	45,000	45,000	45,000	35,500	0	8,500	19,000	7,500	0	5,500	7,500	0	0
172	12,500	12,500	12,500	4,000	0	0	0	3,000	0	0	0	0	0
173	8,000	8,000	8,000	0	0	0	6,500	2,000	0	0	2,000	0	0
174	25,000	25,000	25,000	4,800	0	0	11,000	6,000	0	1,600	11,000	1,700	0
175	53,000	53,000	53,000	29,000	0	13,500	29,500	10,200	0	0	26,000	0	0

TABLE B-6. PETROLEUM REFINERY PROCESS UNIT CAPACITY DATA BASE  
(barrels/day) (Concluded)

Facility	Crude <sup>a</sup> storage	Crude <sup>a</sup> desalting	Atmospheric <sup>a</sup> distillation	Vacuum distil- lation	Vis- breaking	Coking	Catalytic cracking	Catalytic reforming	Distillate upgrading	Catalytic hydro- refining	Naphtha Hydrodesul- furization	Asphalt	Catalytic hydro- cracking
176	164,000	164,000	164,000	95,000	0	50,000	0	56,000	52,000	18,000	38,000	0	0
177	5,000	5,000	5,000	6,000	0	0	0	0	0	0	0	5,000	0
178	85,000	85,000	85,000	36,000	0	0	48,000	25,000	0	7,500	52,500	0	0
179	77,000	77,000	77,000	28,000	0	0	27,500	11,800	0	0	28,500	0	0
180	11,900	11,900	11,900	6,000	0	0	0	0	0	0	0	3,600	0
181	117,000	117,000	117,000	50,000	0	22,000	49,000	21,000	0	0	50,000	0	0
182	32,775	32,775	32,775	19,500	0	0	0	6,000	0	0	11,000	8,000	0
183	19,180	19,180	19,180	2,000	0	0	0	1,500	0	0	0	0	0
184	10,500	10,500	10,500	8,850	0	0	0	3,400	0	0	3,900	0	4,500
185	32,000	32,000	32,000	20,500	0	0	12,000	8,000	0	5,800	9,000	13,500	0
186	40,000	40,000	40,000	17,000	0	0	16,200	7,000	0	0	7,100	0	0
187	36,100	36,100	36,100	19,500	0	8,400	12,500	7,000	0	8,000	7,200	7,000	0
188	22,000	22,000	22,000	8,600	0	0	17,000	6,000	0	0	13,750	1,000	0
189	54,000	54,000	54,000	30,000	0	0	22,000	14,500	0	21,000	26,500	5,000	0
190	12,500	12,500	12,500	0	0	0	7,000	2,750	0	0	0	0	0

<sup>a</sup> Annual Refining Survey. Oil and Gas Journal, March 26, 1990.

TABLE B-7. SUMMARY OF PETROLEUM REFINING INDUSTRY PROCESS UNIT  
WASTEWATER GENERATION FACTORS

Process unit	Direct to drain wastewater generation factor (gal/barrel) <sup>3</sup>	Comments
Crude Storage	2.0	
Crude Desalting	0.002	
Atmospheric Distillation	0.3	
Vacuum Distillation	0.8	
Visbreaking	0.3	Assumed equal to atmospheric distillation
Coking	3.1	
Catalytic Cracking	1.1	
Catalytic Reforming	0.22	
Distillate Upgrading	0.64	Assumed equal to catalytic hydrocracking.
Catalytic Hydrorefining	0.104	Assumed equal to the average of the direct to sewer wastewater generation factor reported for Hydrodesulfurization in Ref. 3.
Naphtha Desulfurization	0.06	
Catalytic Hydrocracking	0.64	
Asphalt Production	0.3	Assumed equal to atmospheric distillation.

TABLE B-8. SUMMARY OF PETROLEUM REFINING INDUSTRY  
COMBINED STREAM VOLATILE ORGANIC  
CONCENTRATIONS

Process Unit	Compound <sup>a</sup>	Total compound concentration (ppmw)	Total organic concentration (ppmw)	Total VO concentration (ppmw) <sup>c</sup>	Comments
Crude Storage	Benzene	26	171	136	
	Toluene	31			
	Xylene	15			
	Non-BTX	99 <sup>b</sup>			
Crude Desalting	Benzene	26	171	136	
	Toluene	31			
	Xylene	15			
	Non-BTX	99 <sup>b</sup>			
Atmospheric Distillation	Benzene	167	1,095	868	
	Toluene	196			
	Xylene	97			
	Non-BTX	635 <sup>b</sup>			
Vacuum Distillation	Benzene	167	1,095	868	Benzene concentration assumed equal to that reported for atmospheric distillation in Ref. 4.
	Toluene	196			
	Xylene	97			
	Non-BTX	635 <sup>b</sup>			
Visbreaking	Benzene	167	1,095	868	
	Toluene	196			
	Xylene	97			
	Non-BTX	635 <sup>b</sup>			
Coking	Benzene	167	1,095	868	
	Toluene	196			
	Xylene	97			
	Non-BTX	635 <sup>b</sup>			
Catalytic Cracking	Benzene	167	1,095	868	
	Toluene	196			
	Xylene	97			
	Non-BTX	635 <sup>b</sup>			

TABLE B-8. SUMMARY OF PETROLEUM REFINING INDUSTRY  
COMBINED STREAM VOLATILE ORGANIC  
CONCENTRATIONS (Concluded)

Process Unit	Compound <sup>a</sup>	Total compound concentration (ppmw)	Total organic concentration (ppmw)	Total VO concentration (ppmw) <sup>c</sup>	Comments
Catalytic Reforming	Benzene	565	3,707	2,940	
	Toluene	664			
	Xylene	328			
	Non-BTX	2,150 <sup>b</sup>			
Distillate Upgrading	Benzene	167	1,095	868	Benzene concentration assumed equal to that reported for atmospheric distillation in Ref. 4.
	Toluene	196			
	Xylene	97			
	Non-BTX	635 <sup>b</sup>			
Catalytic Hydrorefining	Naphthalene	32	97	77	Concentrations based on solubilities of compounds expected to be present.
	1-Methylnaphthalene	28			
	2-Methylnaphthalene	26			
	Biphenyl	7			
	Acenaphthene	4			
Naphtha Desulfurization	Benzene	167	1,095	868	Benzene concentration assumed equal to that reported for naphtha sweetening in Ref. 4.
	Toluene	196			
	Xylene	97			
	Non-BTX	635 <sup>b</sup>			
Catalytic Hydrocracking	Naphthalene	32	97	77	Concentrations based on solubilities of compounds expected to be present.
	1-Methylnaphthalene	28			
	2-Methylnaphthalene	26			
	Biphenyl	7			
	Acenaphthene	4			
Asphalt Production	Benzene	167	1,095	868	Benzene concentration assumed equal to that reported for coking in Ref. 4.
	Toluene	196			
	Xylene	97			
	Non-BTX	635 <sup>b</sup>			

<sup>a</sup>Benzene concentration calculated as the average of the range reported in Ref. 4.

<sup>b</sup>Equal to 58% of the sum of the total organic concentration.

<sup>c</sup>Total VO Concentration (mg/L) = Total organic concentration (mg/L) \* 0.793 (the average ratio of VO concentration to VOC concentration from the SOCM I Section 114 data base).

Individual compound concentration data for refinery products were used to estimate the concentration of non-BTX compounds in refinery wastewater streams. These data indicate that approximately 42 percent of the VO's present in petroleum refinery wastewater is expected to consist of BTX.<sup>5</sup> Therefore, the total concentration of non-BTX VOC's is the BTX concentration multiplied by 1.38 (0.58/0.42). Table B-9 details an example of the use of these scaling factors to calculate the total organic concentration from the assigned benzene concentration.

For all but the catalytic hydrorefining and catalytic hydrocracking process units, the fraction removed (fr) was assumed equal to the VO loading weighted average fr calculated from the SOCFI 114 data base (fr = 0.93). The fr for the catalytic hydrorefining and catalytic hydrocracking process units was calculated to be 0.99, based on the fr of individual compounds expected to be present in the wastewater from these process units.

The individual model streams for petroleum refineries were developed by disaggregating the combined stream data, as described in Section B.2. Table B-10 summarizes these petroleum refining industry model streams.

#### B.1.6 Pulp and Paper Industry

The basis for development of the model streams representing the kraft pulp and paper industry is described in Section 2.6. Condensate streams generated in the kraft pulp and paper industry generally have lower flows and higher VO concentrations than other wastewater streams such as bleach plant effluents. Therefore, the model wastewater streams were developed to represent condensate streams. Condensate stream flow rate factors were developed from condensate flow rates and the facility production rate reported in a steam stripper design report.<sup>6</sup>

Typical condensate stream organic concentrations were obtained from an Agency environmental pollution control document.<sup>7</sup> However, this document did not report concentration

TABLE B-9. EXAMPLE OF TOTAL ORGANIC CONCENTRATION ESTIMATION USING SCALING FACTORS

Compound	Assigned benzene concentration <sup>a</sup> (ppmw)	Scaling factor ratio <sup>b</sup>	Assigned concentration <sup>c</sup> (ppmw)
Benzene	26	---	26
Toluene	---	168/143	31
Xylene	---	83/143	15

Total BTX Concentration (ppmw) = 72 ppmw  
Total Non-BTX Concentration (ppmw) = 99 ppmw<sup>d</sup>  
 Total Organic Concentration (ppmw) = 171 ppmw

<sup>a</sup>Calculated from the linear average of range reported in Reference 4.

<sup>b</sup>Scaling Factor Ratio: Toluene =  $f_{\text{toluene}}/f_{\text{benzene}}$   
 Xylene =  $f_{\text{xylene}}/f_{\text{benzene}}$

<sup>c</sup>Assigned concentration (ppmw) = Assigned Benzene Concentration (ppmw) \* Scaling Factor Ratio

Toluene =  $26 * (168/143) = 31$  ppmw  
 Xylene =  $26 * (83/143) = 15$  ppmw

<sup>d</sup>Total Non-BTX Conc. (ppmw) = Total BTX Conc. (ppmw) \*  
 (0.58/0.42)  
 = 72 (0.58/0.42)  
 = 99

TABLE B-10. MODEL STREAMS: PETROLEUM REFINING INDUSTRY

Process unit	Model stream	Wastewater generation factor (gal/barrel)	VO concentration (ppmw)	fr
Crude Storage	1	1.0	7	0.93
	2	0.8	119	0.93
	3	0.2	849	0.93
Crude Desalting	1	0.001	7	0.93
	2	0.0008	119	0.93
	3	0.0002	849	0.93
Atmospheric Distillation	1	0.15	45	0.93
	2	0.12	760	0.93
	3	0.03	5,416	0.93
Vacuum Distillation	1	0.4	45	0.93
	2	0.32	760	0.93
	3	0.08	5,416	0.93
Visbreaking	1	0.15	45	0.93
	2	0.12	760	0.93
	3	0.03	5,416	0.93
Coking	1	1.6	45	0.93
	2	1.2	760	0.93
	3	0.31	5,416	0.93
Catalytic Cracking	1	0.55	45	0.93
	2	0.44	760	0.93
	3	0.11	5,416	0.93
Catalytic Reforming	1	0.11	153	0.93
	2	0.088	2,575	0.93
	3	0.022	18,346	0.93
Distillate Upgrading	1	0.32	45	0.93
	2	0.26	760	0.93
	3	0.06	5,416	0.93
Catalytic Hydrorefining	1	0.052	4	0.99
	2	0.042	67	0.99
	3	0.010	480	0.99
Naphtha Desulfurization	1	0.03	45	0.93
	2	0.024	760	0.93
	3	0.006	5,416	0.93
Catalytic Hydrocracking	1	0.32	4	0.99
	2	0.26	67	0.99
	3	0.06	480	0.99
Asphalt Production	1	0.15	45	0.93
	2	0.12	760	0.93
	3	0.03	5,416	0.93



data for the hot water accumulator stream, so the organic concentrations for the hot water accumulator stream were calculated as the average of the organic concentrations reported for the other four model streams. This assumption was made because the BOD<sub>5</sub> loading of this wastewater stream, as reported in the steam stripper design report, indicated that the pollutant loading of this stream was approximately equal to the average BOD<sub>5</sub> loading of the other condensate streams. The model stream flow rate generation factors and the development of the total VO concentrations are summarized in Table B-11.

Because only 13 kraft pulp and paper mills are located in areas of ozone nonattainment, the reported production capacities of these mills<sup>8</sup> were used in combination with the flow rate factors to develop the model wastewater streams presented in Table B-12.

## B.2 DISAGGREGATION

Because the available wastewater data for the pesticides manufacturing industry, pharmaceutical manufacturing industry, TSDf, and petroleum refining industry presented flows for combined process unit effluents, rather than for individual wastewater streams, a procedure was developed to disaggregate these combined streams into individual streams. The combined streams were disaggregated into individual streams using a VO loading distribution determined from the 114 survey of SOCMi conducted by the Office of Air Quality Planning and Standards (OAQPS) in 1990.<sup>9</sup> This distribution was determined to be:

- 50 percent of the wastewater flow contains 2.6 percent of the VO loading;
- 40 percent of the wastewater flow contains 35.0 percent of the VO loading; and
- 10 percent of the wastewater flow contains 62.4 percent of the VO loading.

Using the above distribution, the following flow and VO loading factors were defined:

TABLE B-11. SUMMARY OF KRAFT PULP AND PAPER CONDENSATE WASTEWATER STREAM CHARACTERISTICS

Stream No.	1	2	3	4	5
Stream description	Turpentine decanter	Digester blow	Evaporator effects	Evaporator hotwell	Hot water accumulator condensate
Flow (gal/ton) <sup>a</sup>	30	42	212	212	152
Compound	fm				
Dimethyl sulfide	400	70	5	7	120
Dimethyl disulfide	130	50	5	15	50
Methyl mercaptan	250	80	10	40	95
Methanol	6,500	4,300	10,000	1,000	5,450
Ethanol	1,600	500	60	40	550
Acetone	160	40	6	10	54
Total VO conc. (ppmw)	3,568	1,812	3,261	379	2,254

<sup>a</sup>Developed from flows reported in Reference 6 divided by production capacity of facility (1,900 tons/day) reported in Reference 10.

<sup>b</sup>Reference 7.

<sup>c</sup>Average of total organic concentrations reported in Reference 9 for other four condensate streams.

TABLE B-12. MODEL STREAMS: KRAFT PULP AND PAPER MILL CONDENSATE

Mill	Stream	Production capacity (tons/day)	Flow (lpm)	VO concentration (ppmw)	fr
1	1	530	42	3,568	0.92
	2		59	1,812	0.93
	3		295	3,271	0.96
	4		295	398	0.95
	5		212	2,263	0.94
2	1	200	16	3,568	0.92
	2		22	1,812	0.93
	3		111	3,271	0.96
	4		111	398	0.95
	5		80	2,263	0.94
3	1	1,350	106	3,568	0.92
	2		149	1,812	0.93
	3		752	3,271	0.96
	4		752	398	0.95
	5		539	2,263	0.94
4	1	250	20	3,568	0.92
	2		28	1,812	0.93
	3		139	3,271	0.96
	4		139	398	0.95
	5		100	2,263	0.94
5	1	575	45	3,568	0.92
	2		63	1,812	0.93
	3		320	3,271	0.96
	4		320	398	0.95
	5		230	2,263	0.94
6	1	1,650	130	3,568	0.92
	2		182	1,812	0.93
	3		920	3,271	0.96
	4		920	398	0.95
	5		659	2,263	0.94
7	1	700	55	3,568	0.92
	2		77	1,812	0.93
	3		390	3,271	0.96
	4		390	398	0.95
	5		280	2,263	0.94

TABLE B-12. MODEL STREAMS: KRAFT PULP AND PAPER MILL CONDENSATE  
(Concluded)

Mill	Stream	Production capacity (tons/day)	Flow (lpm)	VO concentration (ppmw)	fr
8	1	1,850	146	3,568	0.92
	2		204	1,812	0.93
	3		1,031	3,271	0.96
	4		1,031	398	0.95
	5		739	2,263	0.94
9	1	300	24	3,568	0.92
	2		33	1,812	0.93
	3		167	3,271	0.96
	4		167	398	0.95
	5		120	2,263	0.94
10	1	250	20	3,568	0.92
	2		28	1,812	0.93
	3		139	3,271	0.96
	4		139	398	0.95
	5		100	2,263	0.94
11	1	560	44	3,568	0.92
	2		62	1,812	0.93
	3		312	3,271	0.96
	4		312	398	0.95
	5		224	2,263	0.94
12	1	1,150	91	3,568	0.92
	2		127	1,812	0.93
	3		641	3,271	0.96
	4		641	398	0.95
	5		460	2,263	0.94
13	1	725	57	3,568	0.92
	2		80	1,812	0.93
	3		404	3,271	0.96
	4		404	398	0.95
	5		290	2,263	0.94

<u>Flow Factors</u>	<u>VO Loading Factors</u>
f1 = 0.5	l1 = 0.026
f2 = 0.4	l2 = 0.35
f3 = 0.1	l3 = 0.624

The use of these factors to develop three individual wastewater streams is demonstrated in the following example:

**Example Disaggregation**

<u>Stream</u>	<u>Flow (lpm)</u>	<u>Total VO Concentration (ppmw)</u>
1	71.7	3,530

Using the flow and VO loading factors defined above, and the combined wastewater stream flow (71.7 lpm) and total VO concentration (3,530 ppmw), three disaggregated streams can be defined:

<u>Stream</u>	<u>Flow (lpm)</u>	<u>Total VO Concentration (ppmw)</u>
1-1	Flow * f1 = 71.7 * 0.5 = 35.8	3,530 * (l1/f1) = 3,530 * (0.026/0.5) = 184
1-2	Flow * f2 = 71.7 * 0.4 = 28.7	3,530 * (l2/f2) = 3,530 * (0.35/0.4) = 3,090
1-3	Flow * f3 = 71.7 * 0.1 = 7.2	3,530 * (l3/f3) = 3,530 * (0.624/0.1) = 22,000

Note: streams with flows less than 5 lpm were not disaggregated.

**B.3 ESTIMATION OF UNCONTROLLED EMISSIONS AND EMISSION REDUCTIONS (EXAMPLE CALCULATION)**

Uncontrolled VOC emissions from wastewater streams were estimated using the following equation:

$$\begin{aligned} \text{Uncontrolled VOC Emissions (Mg/yr)} &= \text{VO concentration (ppmw)} * \text{Flow (lpm)} \\ &* 10^{-9} \text{ Mg/mg} * 60 \text{ min/hr} * 8,760 \text{ hr/yr} \\ &* 0.683 \end{aligned}$$

The potential emission reduction achievable for each affected stream was calculated using the following equation:

$$\begin{array}{l} \text{VOC Emission} \\ \text{Reduction} \\ \text{(Mg/yr)} \end{array} = \text{fr}_{\text{avg}} * \begin{array}{l} \text{Uncontrolled} \\ \text{VOC Emissions} \\ \text{(Mg/yr)} \end{array}$$

where:

$\text{fr}_{\text{avg}}$  = the fractional reduction in emission potential achieved by steam stripping

Draft Reference Method 25D measures the VO concentration in a wastewater stream, or provides a relative measure of the emission potential. The fraction of the compound measured ( $f_m$ ) is equal to the ratio of the VO concentration to the VOC concentration:

$$f_m = \text{VO}/\text{VOC}$$

Table B-13 presents the  $f_m$ 's used for all six industries.

To estimate VOC emissions as a function of VO concentration, a relationship for estimating wastewater VOC emissions as a function of VO concentration was derived:

$$\begin{array}{l} \text{VOC Emissions} \\ \text{(Mg/yr)} \end{array} = \begin{array}{l} (f_e/f_m) * \text{VO (ppmw)} * \text{Flow (lpm)} * \\ 10^{-9} \text{ Mg/mg} * 60 \text{ min/hr} * 8,760 \text{ hr/yr} \end{array}$$

where:

$f_e$  = the fraction of total organic compounds in a wastewater stream that would be emitted to the air;  
and

$f_m$  = the fraction of total organic compounds in a wastewater stream measured by Draft Reference Method 25D.

For an individual stream containing multiple compounds, a stream average ratio of  $f_e$  to  $f_m$  can be calculated:

$$(f_e/f_m)_{\text{avg}} = \frac{\sum_i [(f_e/f_m)_i * \text{VO Loading}_i]}{\sum_i \text{VO Loading}_i}$$

TABLE B-13. FRACTION MEASURED (fm) FROM METHOD 25D

Compound Name	fm
Acetal	0.813
Acetaldehyde	0.724
Acetaldehyde Polymer	0.850
Acetaldol	0.025
Acetamide	0.426
Acetic Acid	0.115
Acetic Anhydride	0.361
Acetone	0.829
Acetonitrile	0.739
Acetophenone	0.807
Acifluorfen	0.8886
Acrolein	0.850
Acrylamide	0.003
Acrylic acid	0.454
Acrylonitrile	0.875
Adiponitrile	0.009
Alcohol, acetal, ester	0.813
Aldicarb	0.024
Alkyl benzene	1.000
Allyl alcohol	0.630
Allyl chloride	1.000
Amertryn	0.0229
Aminobiphenyl, 4-	0.097
Ammonia	0.000
Aniline	0.245
Anisidine, o-	0.030
Aziridene Ethyleneimine	0.582
Benzaldehyde	0.108
Benzene (including benzene from gasoline)	1.000
Benzidene	0.000
Benzoic acid	0.010
Benzotrichloride	1.000
Benzyl alcohol	0.288
Benzyl chloride	1.000
Bidimethylaminomethane	0.850
Biphenyl	1.000
Bis(2-ethylhexyl)phthalate (DEHP)	0.968
Bis (Chloromethyl) Ether	0.889
Bisphenol A	0.235
Bromacil	0.5822
Bromodichloromethane	0.047
Bromoform (Tribromomethane)	0.4805
Bromomethane	0.539
Bromoxynil	0.0185
Butadiene, 1,3-	1.000
Butane	1.000
Butanol	0.768
Butanol, n-	0.768

TABLE B-13. FRACTION MEASURED (fm) FROM METHOD 25D  
(Continued)

Compound Name	fm
Butene	1.000
Butyl acetate	0.812
Butyl acrylate	0.858
Butyl alcohol	0.768
Butylamine	0.857
Butylene glycol	0.011
Butylenes	1.000
Butylisobutyrate, n-	0.873
Butyraldehyde, n-	0.867
C-10 Aromatics	1.000
Caprolactam	0.010
Captan	0.093
Carbaryl (Sevin <sup>TM</sup> )	0.277
Carbendazim	0.4067
Carbon disulfide	1.000
Carbon sulfide	0.547
Carbon tetrachloride	1.000
Carbonyl sulfide	0.547
Catechol	0.000
Chlordane	1.000
Chloroacetic acid	0.026
Chloroacetophenone	0.841
Chloroaniline, 2-	0.463
Chloroaniline, m-	0.223
Chloroaniline, o-	0.223
Chloroaniline, p-	0.463
Chlorobenzene	1.000
Chlorobenzilate <sup>TM</sup>	0.989
Chlorobenzotrifluoride, p-	1.000
Chlorobutadiene	1.000
Chlorobutene	1.000
Chloroethane	1.000
Chloroform	1.000
Chlorohydrin	0.009
Chloromethyl methyl ether	0.839
Chloronitrobenzene, o-	0.803
Chloronitrobenzene, p-	0.803
Chlorophenol, o-	0.441
Chlorophenol, p-	0.064
Chloroprene (2-Chloro-1,3-Butadiene)	1.000
Cresols/Cresylic acid (isomers & mixtures)	0.108
Cumene hydroperoxide	1.000
Cumene (isopropyl benzene)	1.000
Cyclohexane	1.000
Cyclohexanol	0.692
Cyclohexanone	0.940
Cyclohexylamine	0.933



TABLE B-13. FRACTION MEASURED (fm) FROM METHOD 25D  
(Continued)

Compound Name	fm
Dazomet	0.3905
Di-isopropylamine	0.939
Diallyl ether	0.973
Diazinon	0.0459
Diazomethane	0.550
Dibenzofurans	1.000
Dibromochloromethane	0.063
Dibromoethane, 1,2-	1.000
Dibromo-3-chloropropane, 1,2-	1.000
Dibromo-4-hydroxybenzotrile	0.1964
Dibutylphthalate	0.316
Dichloroaniline, 2,3-	0.132
Dichloroaniline, 2,3-	1.000
Dichloroaniline, 2,5-	0.132
Dichloroaniline, 3,4-	0.132
Dichlorobenzene, 1,4-	1.000
Dichlorobutene	1.000
Dichloroethane, 1,1-	1.000
Dichloroethyl ether	0.939
Dichlorophenol, 2,4-	0.369
Dichlorophenol, 2,5-	0.476
Dichlorophenol, 2,6-	0.476
Dichlorophenol, 3,4-	0.369
Dichloropropane, 1,2-	1.000
Dichloropropene, 1,3-	1.000
Dichlorvos	0.012
DIDP (Diisodecyl phthalate)	0.981
Diethanolamine	0.000
Diethyl sulfate	0.014
Diethylaniline, N,N-	1.000
Diethylthiophosphatebenzomethane	0.023
Diisobutylene	1.000
Diisopropylamine	0.939
Diisopropyl ether	0.939
Diisopropylbenzene	1.000
Dimethoxy-(3,3')-benzidine	0.005
Dimethyl carbamoyl chloride	0.247
Dimethyl disulfide	0.5899
Dimethyl ether	0.698
Dimethyl formamide	0.009
Dimethyl hydrazine, 1,1-	0.486
Dimethylphenol, 2,4-	0.057
Dimethyl phthalate	0.098
Dimethyl sulfate	0.077
Dimethyl sulfide	0.508
Dimethylacetamide	0.708
Dimethylamine	0.709

TABLE B-13. FRACTION MEASURED (fm) FROM METHOD 25D  
(Continued)

Compound Name	fm
Dimethylsulfone	0.008
Dimethylsulfoxide	0.0747
Di-n-butyl phthalate	0.762
Dinitrobenzenes	0.564
Dinitro-o-cresol, 4,6- and salts	0.044
Dinitrophenol, 2,4-	0.014
Dinitrotoluene, 2,4-	0.004
Diocetyl phthalate	0.965
Dioxane, 1,4- (1,4-Diethyleneoxide)	0.681
Diphenyl ether	1.000
Diphenylhydrazine, 1,2-	1.000
DIPK	0.973
Dipropyl Butyral	1.000
Dipropylene glycol	0.029
DOE, p,p-	1.000
EGMBE acetate	0.033
Epichlorohydrin	0.859
Epoxybutane, 1,2-	0.879
Ethane	1.000
Ethanol	0.623
Ethlene dibromide	1.000
Ethyl acetate	0.724
Ethyl acrylate	0.788
Ethyl alcohol	0.623
Ethyl benzene	1.000
Ethyl carbamate	0.011
Ethyl chloride (Chloroethane)	1.000
Ethyl ether	0.856
Ethyl morpholine	0.159
Ethyl vinyl ether	0.890
Ethylene	1.000
Ethylene dichloride (1,2-Dichloroethane)	1.000
Ethylene glycol	0.004
Ethylene oxide	0.712
Ethylene thiourea	0.001
Ethylenediamine	0.034
Ethylhexanol	0.941
Ethylhexanol, 2-	0.941
Ethylidene dichloride (1,2-Dichloroethane)	1.000
Formaldehyde	0.533
Formic Acid	0.064
Freon 11 and 12	1.000
Fumaronitrile	0.850
Glycerol	0.000
Glycol ethers	0.850
Glyoxal	0.535
Glyphosate	0.0034

TABLE B-13. FRACTION MEASURED (fm) FROM METHOD 25D  
(Continued)

Compound Name	fm
Guthion	0.0094
Heptachlor	1.000
Heptane	1.000
Hexachlorobenzene	1.000
Hexachlorobutadiene	1.000
Hexachlorocyclopentadiene	1.000
Hexachloroethane	1.000
Hexafluoroacetone	0.968
Hexamethylene-1,6-diisocyanate	0.088
Hexamethylphosphoramide	0.000
Hexane	1.000
Hexanone, 2-	0.940
Hydrazine	0.573
Hydrogen cyanide	0.000
Hydroquinone	0.000
Hydroxyacetic acid	0.001
Isobutyl isobutyrate	0.873
Isobutanol	0.852
Isobutryaldehyde	0.886
Isobutylene	1.000
Isobutyric acid	0.750
Isodecanol	0.923
Isophorone	0.997
Isopropyl acetate	0.786
Isopropyl alcohol	0.793
Isopropyl ether	0.939
Isopropylamine	0.811
Lindane	1.000
Maleic Acid	0.001
Maleic anhydride	0.510
Merpel 6169 (PEG 32)	0.000
Merpel 6344 (PEG 180)	0.000
Methacrylic acid	0.154
Methanol	0.321
Methomyl	0.0426
Methoxychloride	1.000
Methyl Acetate	0.627
Methyl benzyl alcohol	0.284
Methyl bromide (Bromoethane)	0.539
Methyl chloride (Chloromethane)	1.000
Methylene chloride (Dichloromethane)	1.000
Methylenedianiline, 4,4-	0.007
Methylene diphenyl diisocyanate (MDI)	0.473
Methyl ethyl ketone (2-Butanone)	0.881
Methyl hydrazine	0.052
Methyl iodide	0.354
Methyl isobutyl ketone (Hexone)	0.954

TABLE B-13. FRACTION MEASURED (fm) FROM METHOD 25D  
(Continued)

Compound Name	fm
Methyl isocyanate	0.271
Methyl methacrylate	0.802
Methyl morpholine	0.668
Methylnaphthalene, 1-	1.000
Methylnaphthalene, 2-	1.000
Methyl-tertiary-butyl ether	0.911
Methyl isopropyl ketone (MIPK)	0.931
Misc. HAPs	0.850
Misc. organics	0.850
Misc. Organics	0.850
Misc. paraffins	0.850
Misc. paraffins and olefins	0.850
Mixed xylidenes	0.388
Monoadducts	0.850
Monoester	0.850
Monoethanolamine	0.006
Monomethylformamide	0.002
Monopropylene glycol	0.000
Morpholine	0.251
Nabam	0.000
Naphthalene	1.000
Naphthol, alpha-	1.000
Naphthol, beta-	0.012
Naphthol ( $\beta$ -naphthol), 2-	0.012
Naphthoquinone, 1,4-	0.250
Nitroaniline, p-	0.000
Nitrobenzene	0.575
Nitrophenol, 4-	0.001
Nitropropane, 2-	0.537
Nitrosodimethylamine, N-	0.118
Nitrosomorpholine	0.061
Nitroso-n-methylurea, N-	0.380
Nitrotoluene	0.800
Nitrotoluene isomers	0.800
Nitrotoluene, m-	0.786
Nitrotoluene, o-	0.800
Nitrotoluene, p-	0.712
Nitroxylene	0.844
Nonanol, n-	0.844
Octane	1.000
Oil	0.850
Oils	0.850
Olefins and 2AB	0.850
Other Chlorophenols	0.441
Other nitrocresols	0.800
Palatinol, N-	0.850
Paraffins and alkylates	0.850

TABLE B-13. FRACTION MEASURED (fm) FROM METHOD 25D  
(Continued)

Compound Name	fm
Parathion	0.007
PEG 15EO	0.000
PEG 3350	0.000
PEG 3EO	0.000
PEG 520EO	0.000
PEG 60EO	0.000
PEG 77EO	0.000
PEG 7EO	0.000
Pentachlorobenzene	1.000
Pentachlorophenol	0.430
Pentaerythritol	0.002
Perchloroethane	1.000
Phenol	0.057
Phenolic salts	0.000
Phenylenediamine, m-	0.580
Phenylenediamine, o-	0.580
Phenylenediamine, p-	0.001
Phosgene	0.868
Phosphine	0.213
Phthalic anhydride	0.101
Piperazine	0.0013
PNCB	0.803
Polyvinyl alcohol	1.000
Propane Sultone, 1,3-	0.005
Propanol	0.399
Propanone, 2-	0.829
Propene	1.000
Propiolacetone, beta	0.243
Propionaldehyde	0.813
Proporur (Baygon)	0.099
Propylene	1.000
Propylene chlorohydride	0.549
Propylene dichloride	1.000
Propylene glycol	1.000
Propylene oxide	0.841
Propylene imine (2-Methylaziridine)	0.811
Pyridine	0.721
Quinoline	0.018
Quinone	0.868
Resorcinol	0.000
Sodium Acetate	0.000
Sodium Chloroacetate	0.000
Sodium Formate	0.000
Soluble organic lead	1.000
Styrene	1.000
Styrene oxide	1.000
Succinonitrile	0.850

TABLE B-13. FRACTION MEASURED (fm) FROM METHOD 25D  
(Continued)

Compound Name	fm
Tertiary butyl alcohol	0.768
Tamaron (Methamidiphos)	0.5289
Tars	1.000
Terephthalic acid	0.004
Terpineol, alpha-	1.000
Tetrachlorodibenzo-p-Dioxin, 2,3,4,8-	1.000
Tetrachloroethane, 1,1,2,2-	1.000
Tetrachloroethene	1.000
Tetrachloroethylene (Perchloroethylene)	1.000
Tetrachlorophenol	1.000
Tetrachlorophenol, 2,3,4,6-	1.000
Tetrachlorophenol, 2,3,5,6-	1.000
Tetraethylene pentamine	0.000
Tetraethyllead	1.000
Tetrafluoromethane	1.000
Total organic carbon	0.850
Toluene	1.000
Toluene diamine, 2,4-	0.001
Toluene diisocyanate, 2,4-	0.002
Toluenesulfonyl chloride	0.338
Toluidiene	0.267
Toluidine, m-	0.267
Toluidine, o-	0.267
Toluidine, p-	0.545
Total Organics	0.850
Toxaphene	0.968
Trans-1,2-Dichloroethene	1.000
Tributyl phosphorotrithioate, S,S,S-	0.0034
Tributyl tin acetate	0.9484
Trichlorobenzene, 1,2,4-	1.000
Trichloroethane 1,1,1- (Methyl chloroform)	1.000
Trichloroethane, 1,1,2-	0.966
Trichloroethylene	1.000
Trichlorophenol, 2,3,4-	0.396
Trichlorophenol, 2,4,5-	0.286
Trichlorophenol, 2,4,6-	0.396
Trichlorophenol, 3,4,5-	0.396
Trichloropropane	1.000
Triethylamine	0.930
Trifluralin	0.736
Triisobutylene	1.000
Trimethylpentane, 2,2,4-	1.000
Triisopropylamine	1.000
Trimethyl benzenes	1.000
Tripropylene glycol	0.112

TABLE B-13. FRACTION MEASURED (fm) FROM METHOD 25D  
(Concluded)

Compound Name	fm
Vinyl acetate	0.748
Vinyl acetylene	1.000
Vinyl chloride	1.000
Vinylidene chloride	1.000
Xylenes (isomers and mixture)	1.000
Xylidine	0.388

Substituting the definition for  $f_e/f_m$ , and expressing the VO loading as the VO concentration multiplied by the wastewater flow yields:

$$(f_e/f_m)_{avg} = \frac{\sum_i \left[ \left[ \frac{f_e}{f_m} \right]_i * VO \text{ Concentration}_i (\text{mg/l}) * \text{Flow} (\text{lpm}) \right]}{\sum_i [VO \text{ Concentration}_i (\text{mg/l}) * \text{Flow} (\text{lpm})]}$$

Using this equation, a weighted average value of 0.683 was calculated from the 461 wastewater streams reported in response to the 1990 SOCFI Section 114 survey. The resulting emission estimation equation was used to calculate the uncontrolled VOC emissions from the example wastewater streams for each of the affected industries in Appendix B:

$$\begin{aligned} \text{VOC Emissions (Mg/yr)} &= \text{VO concentration (mg/l)} * \text{Flow (lpm)} * \\ &10^{-9} \text{ Mg/mg} * 60 \text{ min/hr} * 8,760 \text{ hr/yr} * \\ &0.683 \end{aligned}$$

The use of these equations is shown in the following example:

Example Calculation 1

OCPSF Manufacturing Plant

Stream 1121

VO Concentration = 521 ppmw (from Table B-2)

Flow = 11.36 lpm

$f_r = 0.93$

Uncontrolled VOC Emissions (Mg/yr) =

521 ppmw	11.36 l	$10^{-9}$ Mg	60 min	8,760 hr	* 0.683
	min	mg	hr	yr	

= 2.12 Mg/yr



$$\begin{aligned}
 \text{VOC Emission Reduction (Mg/yr)} &= \text{fr} * \text{Uncontrolled VOC Emissions (Mg/yr)} \\
 &= 0.93 * 2.12 \text{ Mg/yr} \\
 &= 1.97 \text{ Mg/yr}
 \end{aligned}$$

Similar calculations are performed for all other affected streams.

#### B.4 COST AND SECONDARY ENVIRONMENTAL IMPACTS OF CONTROL

The equations for estimating total capital investment (TCI) and total annualized costs (TAC) of a carbon steel steam stripper are derived in Chapter 5.0. With a steam-to-feed ratio (SFR) of 0.8 lb/gal, the equations are:

$$\begin{aligned}
 \text{TCI (\$)} &= 239,645 + 837.9 * (\text{Wastewater Feed Rate, } \ell\text{pm}) \\
 \text{TAC (\$/yr)} &= 72,812 + 639.0 * (\text{Wastewater Feed Rate, } \ell\text{pm})
 \end{aligned}$$

For the example calculation begun in Section B.3, the facility's flow from all its model wastewater streams requiring treatment under the specified RACT option is 401.0  $\ell$ pm.

Therefore:

$$\begin{aligned}
 \text{TCI} &= 239,645 + 837.9 * (401) = \$575,600 \\
 \text{TAC} &= 72,812 + 639.0 * (401) = \$329,000/\text{yr}
 \end{aligned}$$

This assumes the installation of a single steam stripper. Similar calculations are performed for each individual SOCOMI facility.

To account for lower steam requirements for streams with more volatile compounds, new cost equations were derived for lower SFR's. Next, those streams which can achieve 99 percent removal with a lower SFR were identified in the OCPSF data base. The costs were calculated for the more volatile streams at the appropriate SFR while the costs of the remaining streams were calculated using the cost equation presented above. For the majority of these more volatile streams, the optimal SFR was 0.1 and the applicable TCI and TAC equations were:

$$\begin{aligned}
 \text{TCI (\$)} &= 235,664 + 771.0 * (\text{flow}) \\
 \text{TAC (\$/yr)} &= 72,239 + 240.9 * (\text{flow})
 \end{aligned}$$

It was assumed that only one steam stripper was installed per facility and that those facilities requiring different SFR's will adjust the SFR accordingly.

The costs were totaled and scaled up to obtain national impacts (see Section B.5.1). For each RACT option, the national costing impacts (e.g., TAC) for lowering the SFR was compared to the cost of treating all the streams at an SFR of 0.8. Scaling factors for lower costs at each RACT option were calculated. These option-specific scaling factors were applied to reduce the TAC to the remaining five industries.

The secondary impacts of RACT implementation are a product of the electricity required to generate the steam. The equation used to calculate these secondary pollution emissions utilizes the fuel composition, heat values of said fuels and steam, and air pollution control efficiencies presented in Section 5.2.2. The following pollution emissions, after applying the appropriate controls, are estimated for steam generation using these equations:<sup>11</sup>

$$\begin{aligned} \text{PM (Mg/yr)} &= \text{WW flow} * [(0.0006 \text{ Mg PM} * \text{min}) / (\ell * \text{yr})] \\ \text{SO}_2 \text{ (Mg/yr)} &= \text{WW flow} * [(0.005 \text{ Mg SO}_2 * \text{min}) / (\ell * \text{yr})] \\ \text{NO}_x \text{ (Mg/yr)} &= \text{WW flow} * [(0.015 \text{ Mg NO}_x * \text{min}) / (\ell * \text{yr})] \\ \text{CO (Mg/yr)} &= \text{WW flow} * [(0.002 \text{ Mg CO} * \text{min}) / (\ell * \text{yr})] \\ \text{VOC (Mg/yr)} &= \text{WW flow} * [(0.0001 \text{ Mg VOC} * \text{min}) / (\ell * \text{yr})] \end{aligned}$$

where:

$$\text{WW flow} = \text{Wastewater flow } (\ell\text{pm})$$

The secondary impacts are presented in Section B.5.7.

#### B.5 NATIONAL IMPACTS ESTIMATES

As discussed in Section B.4, the representative model streams are used to calculate the following RACT impacts: uncontrolled VOC emissions, emission reductions total capital investment, total annual cost, cost effectiveness, and incremental cost effectiveness. After these RACT impacts (excluding incremental cost effectiveness) are calculated on a model stream basis, the total impacts for all the model streams must be appropriately scaled to estimate the impacts of applying RACT on a national basis. The development and actual

national impacts for the six industries discussed in this document are presented in the following sections.

#### B.5.1 Organic Chemicals, Plastics, and Synthetic Fibers

Table B-14 presents OCPSF RACT national impacts. The impacts of applying RACT to the model wastewater streams discussed in Section B.1.1 were scaled up to a national level using a flow-based scaling factor. This flow scaling factor accounts for that portion of the industry that will be controlled by the hazardous organic national emission standards for hazardous air pollutants (HON) and will not require additional control (235,000  $\ell$ pm). The flow factor also accounts for the 43 percent of the facilities located in areas of nonattainment for ozone. The total OCPSF industry flow is 1,374,800  $\ell$ pm. The resulting flow scaling factor equation is:

OCPSF Scaling Factor =

$$\begin{aligned} & \frac{(\text{OCPSF Flow}^a - \text{HON Flow}^b)}{(\text{Model Stream Flow})} * \text{Fraction of} \\ & \qquad \qquad \qquad \text{Facilities Located in} \\ & \qquad \qquad \qquad \text{Nonattainment Areas} \\ = & \frac{(1,374,800 - 235,000)}{(30,739)} * 0.43 \\ & = 15.94 \end{aligned}$$

<sup>a</sup>Flow given from the EPA 308 survey which is the direct contact process water use for OCPSF.

<sup>b</sup>The amount of wastewater flow controlled by the HON at a maximum achievable control technology (MACT) standard of 500 ppmw volatile hazardous air pollutant (VHAP) and 1  $\ell$ pm.

#### B.5.2 Pesticides Manufacturing Industry

Table B-15 presents pesticide RACT national impacts. The impacts of applying RACT to the model streams discussed in Section B.1.2 were scaled up to a national level using a flow based scaling factor. This flow factor accounts for the 36 percent of the facilities located in areas of nonattainment

TABLE B-14. ORGANIC CHEMICALS, PLASTICS, AND SYNTHETIC FIBERS  
RACT OPTIONS NATIONAL IMPACTS

Option description*		VOC emission reduction (Mg/yr)	Percent VOC emission reduction	Percent wastewater flow controlled	Percent wastewater stream controlled	Total capital cost (MM\$)	Total annual cost (MM\$/yr)	Average cost effectiveness (\$/Mg)
VOC concentration cutoff (ppmw)	Flow rate cutoff (lpm)							
1,000	10	213,000	85%	21%	20%	160	85	400
500	1	225,000	89%	29%	30%	200	100	460
200	1	230,000	91%	39%	37%	240	130	550
100	1	231,000	92%	46%	41%	270	150	630
TIC		234,000	93%	100%	100%	500	320	1,400

\*All options include a maximum VOC concentration cutoff of 10,000 ppmw.

Baseline VOC Emissions = 250,000 Mg/yr

Total Wastewater Volume = 490,000 lpm

Total Number Wastewater Streams = 7,300

TIC = Total Industry Control

TABLE B-15. PESTICIDES RACT OPTIONS NATIONAL IMPACTS

Option description*		VOC emission reduction (Mg/yr)	Percent VOC emission reduction	Percent wastewater flow controlled	Percent wastewater stream controlled	Total capital cost (MM\$)	Total annual cost (MM\$/yr)	Average cost effectiveness (\$/Mg)
VO concentration cutoff (ppmw)	Flow rate cutoff (#pm)							
1,000	10	1,400	73%	20%	23%	4.4	1.5	1,200
500	1	1,500	79%	24%	37%	5.2	1.8	1,200
200	1	1,600	83%	43%	48%	7.1	2.5	1,600
100	1	1,600	84%	49%	57%	7.4	2.7	1,700
TIC		1,600	85%	100%	100%	11	4.7	2,900

\*All options include a maximum VO concentration cutoff of 10,000 ppmw.

Baseline VOC Emissions = 1,900 Mg/yr

Total Wastewater Volume = 4,700 #pm

Total Number Wastewater Streams = 190

TIC = Total Industry Control

for ozone. The total pesticide industry wastewater flow is 12,934  $\ell$ pm. The resulting scale-up equation is:

$$\begin{aligned} & \text{Pesticide Scaling Factor} = \\ & \frac{\text{Industry Total Wastewater Flow} * \text{Fraction of Facilities Located in Nonattainment Areas}}{\text{Model Stream Total Flow}} \\ & = \frac{(12,934 \ell\text{pm}) * (0.36)}{(1,838 \ell\text{pm})} \\ & = 2.533 \end{aligned}$$

### B.5.3 Treatment, Storage, and Disposal Facilities

Table B-16 presents TSDf RACT impacts on a national basis. The impacts of applying RACT to the model streams discussed in Section B.1.3 were scaled to national impacts using a flow based scaling factor. This flow factor accounts for the 43 percent of the facilities located in areas of nonattainment for ozone. The flow factor also accounts for the wastewater flow already regulated by the Benzene NEShAP (approximately 14.7 percent), and the assumption that the flow of the model streams represents 45 percent of the total industry flow. The resulting scaling equation is:

$$\begin{aligned} & \text{TSDf Scaling Factor} = \\ & \frac{(\text{Industry Total Wastewater Flow}) * (\text{Fraction of Facilities Located in Nonattainment Areas}) * (1 - \text{Fraction of Flow Regulated by Benzene NEShAP})}{18,999} \\ & = \frac{42,060 * (0.43) * (1 - 0.147)}{18,999} \\ & = 0.81 \end{aligned}$$

### B.5.4 Pharmaceutical Manufacturing Industry

Table B-17 presents pharmaceutical RACT impacts on a national basis. The impacts of applying RACT to the model streams discussed in Section B.1.4 were averaged on a facility basis. This facility average RACT impact was multiplied by the number of facilities in each pharmaceutical subcategory. The impacts of each combination of subcategories (e.g., A, AC, ACD,

TABLE B-16. TREATMENT, STORAGE, AND DISPOSAL FACILITIES RACT OPTIONS NATIONAL IMPACTS

Option description*		VOC emission reduction (Mg/yr)	Percent VOC emission reduction	Percent wastewater flow controlled	Percent wastewater stream controlled	Total capital cost (MM\$)	Total annual cost (MM\$/yr)	Average cost effectiveness (\$/Mg)
VOC concentration cutoff (ppmw)	Flow rate cutoff (lpm)							
1,000	10	1,900	61%	9%	18%	3.5	1.7	910
500	1	1,900	61%	9%	20%	3.7	1.8	940
200	1	2,000	63%	14%	24%	5.2	2.6	1,300
100	1	2,000	65%	24%	39%	8.3	4.3	2,100
TIC		2,100	65%	100%	100%	22	13	6,200

\*All options include a maximum VOC concentration cutoff of 10,000 ppmw.  
 Baseline VOC Emissions = 3,100 Mg/yr  
 Total Wastewater Volume = 15,000 lpm  
 Total Number Wastewater Streams = 40  
 TIC = Total Industry Control

TABLE B-17. PHARMACEUTICALS RACT OPTIONS NATIONAL IMPACTS

Option description*		VOC emission reduction (Mg/yr)	Percent VOC emission reduction	Percent wastewater flow controlled	Percent wastewater stream controlled	Total capital cost (MM\$)	Total annual cost (MM\$/yr)	Average cost effectiveness (\$/Mg)
VOC concentration cutoff (ppmw)	Flow rate cutoff (lpm)							
1,000	10	18,000	70%	14%	21%	43	17	940
500	1	20,000	76%	22%	46%	71	25	1,300
200	1	21,000	82%	46%	52%	87	35	1,600
100	1	21,100	83%	49%	65%	90	36	1,700
TIC		21,400	84%	100%	100%	144	68	3,200

\*All options include a maximum VO concentration cutoff of 10,000 ppmw.

Baseline VOC Emissions = 25,000 Mg/yr

Total Wastewater Volume = 76,000 lpm

Total Number Wastewater Streams = 3,000

TIC = Total Industry Control



AD, C, CD, D) are added together. This total is then multiplied by the percent of facilities in nonattainment (57 percent). The resulting scaling equation is:

Pharmaceutical Scaling Factor =

$$\sum (\text{impact} * \text{No. of Facilities in Each Subcategory}) * \text{Fraction of Facilities Located in Nonattainment Areas}$$

where:

Fraction of Facilities located in nonattainment areas = 0.57

No. of facilities in each subcategory:

A only	15
AC	9
ACD	20
AD	26
C only	50
CD	67
D only	403

Table B-18 presents RACT impacts on a national basis for Subcategory C (Chemical Synthesis) only.

#### B.5.5 Petroleum Refining

Table B-19 presents petroleum refining RACT impacts on a national basis. The impacts of applying RACT to the model streams discussed in Section B.1.5 were scaled to national impacts based on the percent of facilities in nonattainment (52 percent) and the wastewater flow already regulated by the Benzene NESHAP (67 percent). The resulting scaling factor is:

Petroleum Refining Scaling Factor

$$= \text{(Fraction of Facilities Located in Nonattainment Areas)} * \text{(1 - Fraction of Flow Regulated by Benzene NESHAP)}$$

$$= (0.52) * (1 - 0.67)$$

$$= 0.17$$

TABLE B-18. PHARMACEUTICALS (SUBCATEGORY C ONLY) RACT OPTIONS NATIONAL IMPACTS

Option description*		VOC emission reduction (Mg/yr)	Percent VOC emission reduction	Percent wastewater flow controlled	Percent wastewater stream controlled	Total capital cost (MM\$)	Total annual cost (MM\$/yr)	Average cost effectiveness (\$/Mg)
VO concentration cutoff (ppmw)	Flow rate cutoff (lpm)							
1,000	10	15,600	74%	18%	35%	27	11	720
500	1	16,000	76%	20%	47%	27	11	680
200	1	17,000	82%	51%	62%	43	20	1,200
100	1	17,000	82%	51%	62%	43	20	1,200
TIC		17,500	83%	100%	100%	65	38	2,100

\*All options include a maximum VO concentration cutoff of 10,000 ppmw.  
 Baseline VOC Emissions = 21,000 Mg/yr  
 Total Wastewater Volume = 53,000 lpm  
 Total Number Wastewater Streams = 500  
 TIC = Total Industry Control

TABLE B-19. PETROLEUM REFINING RACT OPTIONS NATIONAL IMPACTS

Option description*		VOC emission reduction (Mg/yr)	Percent VOC emission reduction	Percent wastewater flow controlled	Percent wastewater stream controlled	Total capital cost (MM\$)	Total annual cost (MM\$/yr)	Average cost effectiveness (\$/Mg)
VO concentration cutoff (ppmw)	Flow rate cutoff (lpm)							
1,000	10	1,700	41%	3%	10%	7.9	2.6	1,600
500	1	3,700	91%	27%	43%	21	7.9	2,100
200	1	3,700	91%	27%	44%	21	7.7	2,100
100	1	3,900	97%	50%	51%	31	12	3,200
TIC		4,000	100%	100%	100%	44	21	5,300

\*All options include a maximum VO concentration cutoff of 10,000 ppmw.  
 Baseline VOC Emissions = 4,000 Mg/yr  
 Total Wastewater Volume = 25,000 lpm  
 Total Number Wastewater Streams = 720  
 TIC = Total Industry Control

#### B.5.6 Pulp and Paper Industry

Table B-20 presents the pulp and paper national RACT impacts. There are only 13 integrated pulp and paper mills located in areas of ozone nonattainment. The data from these 13 mills were used to calculate the model streams and the resulting RACT impacts. Because these are the only facilities affected by this CTG, the model stream RACT impacts are equivalent to the national RACT impacts.

#### B.5.7 Secondary Impacts

Table B-21 presents the VOC emission reductions and secondary impacts from each of the industries at the RACT option of 500 ppm and 1 lpm flow.

TABLE B-20. PULP AND PAPER RACT OPTIONS NATIONAL IMPACTS

Option description*		VOC emission reduction (Mg/yr)	Percent VOC emission reduction	Percent wastewater flow controlled	Percent wastewater stream controlled	Total capital cost (MM\$)	Total annual cost (MM\$/yr)	Average cost effectiveness (\$/Mg)
VOC concentration cutoff (ppmw)	Flow rate cutoff (lpm)							
1,000	10	11,000	89%	67%	80%	13	8.0	720
500	1	11,000	89%	67%	80%	13	8.0	720
200	1	12,000	95%	100%	100%	18	10	1,000
100	1	12,000	95%	100%	100%	18	10	1,000
TIC		12,000	95%	100%	100%	18	11	1,000

\*All options include a maximum VO concentration cutoff of 10,000 ppmw.

Baseline VOC Emissions = 12,000 Mg/yr

Total Wastewater Volume = 17,000 lpm

Total Number Wastewater Streams = 65

TIC = Total Industry Control

TABLE B-21. VOLATILE ORGANIC COMPOUND EMISSION REDUCTIONS  
AND SECONDARY IMPACTS

RACT Option: 500 ppmw  
1 lpm

Industry	VOC emission reduction (Mg/yr)	Secondary impacts (Mg/yr)				
		PM	SO <sub>2</sub>	NO <sub>x</sub>	CO	VOC
DCPSF	225,000	86	720	2,100	290	14
Pesticides	1,500	1.0	5.5	17	2.2	0.1
TSDF	1,900	1.0	8.3	25	3.3	0.2
Pharmaceuticals	20,000	10	83	250	33	1.7
<b>TOTAL</b>	<b>248,400</b>	<b>98</b>	<b>820</b>	<b>2,400</b>	<b>330</b>	<b>16</b>

## B.6 REFERENCES

1. Memorandum from Brailsford, J., Radian Corporation, to F. E. Manning, U.S. Environmental Protection Agency. Regarding Calculation of  $f_m$ . December 3, 1991.
2. Annual Refining Survey. Oil and Gas Journal. March 26, 1990.
3. U. S. Environmental Protection Agency. VOC Emissions from Petroleum Refinery Wastewater Systems--Background Information Document for Proposed Standards. EPA-450/3-85-001a. February 1985.
4. U. S. Environmental Protection Agency. Final NESHAP Standards for Waste Operations: Basis for Impacts Calculations. February 16, 1990.
5. Memorandum from Bagley C., Radian Corporation to Project File. Assignment of Total Organic Concentrations to Petroleum Refinery Model Wastewater Streams. March 31, 1992.
6. Letter from Breed, D. H., Union Camp, to S. R. Wyatt, U. S. Environmental Protection Agency. BOD<sub>5</sub> Reduction Using Condensate Stripping, Union Camp Corporation, Franklin, Virginia. November 17, 1989.
7. U. S. Environmental Protection Agency. Environmental Pollution Control, Pulp and Paper Industry, Part I-Air. EPA-625/7-76-001. October 1976.
8. 1991 Lockwood-Post's Directory of the Pulp, Paper, and Allied Trades. Miller Freeman Publications. 1990. pp. 42, 67 to 68, 72 to 73, 82 to 85, 105, 111, 124 to 126, 130 to 134.
9. Memorandum from Bagley, C., Radian Corporation, to F. E. Manning, U. S. Environmental Protection Agency. Development of Volatile Organic Wastewater Loading Distribution from Responses to the March 1990 Section 114 Wastewater Questionnaire. May 5, 1992.
10. Trip Report. Elliott, J. A., and S. L. Watkins, Radian Corporation, to file. 8 p. Report of September 25, 1989, visit to Union Camp Corporation.
11. Memorandum from Zukor, C., Radian Corporation, to F. E. Manning, U. S. Environmental Protection Agency. Development of Environmental Impact Factors for Steam Stripping Wastewater Streams in the Industrial Wastewater Control Techniques Guideline (IWW CTG) Document. January 31, 1992.

October 1993

**Addendum to September 1992**

**Draft Industrial Wastewater  
Control Techniques Guideline Document**

The tables in this Addendum are the same as the tables presented in Chapter 6 and Appendix B with the addition of two options and a correction to the Pesticides RACT Options Table. The two additional options included are 1,000 ppmw at 1 lpm and 500 ppmw at 10 lpm. The correction to the Pesticides RACT Options Table is concerning the total annual cost value for the 1,000 ppmw 10 lpm option which should be 1.6 MM\$/yr instead of the 1.5 MM\$/yr value in table on page B-57.



TOTAL INDUSTRY RACT OPTIONS NATIONAL IMPACTS

Option description			VOC emission reduction (Mg/yr)	Percent VOC emission reduction	Total national capital cost (MM\$)	Total national annual cost (MM\$/yr)	National cost effectiveness (\$/Mg)	Incremental cost effectiveness (\$/Mg)
VO concentration cutoff (ppmw)	Flow rate cutoff (lpm)	Maximum VO concentration (ppmw)						
1,000	10	10,000	232,000	83%	190	100	430	
1,000	1	10,000	234,000	84%	210	100	440	230
500	10	10,000	242,000	87%	240	120	470	2,500
500	1	10,000	244,000	88%	240	120	480	(1,200)
200	1	10,000	251,000	90%	300	150	610	5,700
100	1	10,000	252,000	91%	330	170	690	13,800
TIC			255,000	92%	600	380	1,500	65,900

Baseline VOC emissions = 278,000 Mg/yr  
 Total wastewater volume = 563,000 lpm  
 Total number wastewater streams = 8,100  
 TIC = Total Industry Control

**ORGANIC CHEMICALS, PLASTICS, AND SYNTHETIC FIBERS  
RACT OPTIONS NATIONAL IMPACTS**

Option description			VOC emission reduction (Mg/yr)	Percent VOC emission reduction	Percent wastewater flow controlled	Percent wastewater stream controlled	Total capital cost (MM\$)	Total annual cost (MM\$/yr)	Average cost effectiveness (\$/Mg)
VOC concentration cutoff (ppmw)	Flow rate cutoff (lpm)	Maximum VOC concentration (ppmw)							
1,000	10	10,000	213,000	85%	21%	20%	160	85	400
1,000	1	10,000	214,000	85%	21%	24%	170	88	410
500	10	10,000	223,000	89%	29%	24%	200	100	460
500	1	10,000	225,000	89%	29%	30%	200	100	460
200	1	10,000	230,000	91%	39%	37%	240	130	550
100	1	10,000	231,000	92%	46%	41%	270	150	630
TIC			234,000	93%	100%	100%	500	320	1,400

Baseline VOC emissions = 252,000 Mg/yr  
 Total wastewater volume = 490,000 lpm  
 Total number wastewater streams = 7,300  
 TIC = Total Industry Control

PESTICIDES RACT OPTIONS NATIONAL IMPACTS

Option description			VOC emission reduction (Mg/yr)	Percent VOC emission reduction	Percent wastewater flow controlled	Percent wastewater stream controlled	Total capital cost (MM\$)	Total annual cost (MM\$/yr)	Average cost effectiveness (\$/Mg)
VO concentration cutoff (ppmw)	Flow rate cutoff (lpm)	VO maximum concentration (ppmw)							
1,000	10	10,000	1,400	73%	20%	23%	4.4	1.6	1,200
500	10	10,000	1,400	74%	21%	24%	5.1	1.8	1,300
1,000	1	10,000	1,500	78%	22%	35%	5.1	1.9	1,300
500	1	10,000	1,500	79%	24%	37%	5.2	1.8	1,200
200	1	10,000	1,600	83%	43%	48%	7.1	2.5	1,600
100	1	10,000	1,600	84%	49%	57%	7.4	2.7	1,700
TIC			1,600	85%	100%	100%	11	4.7	2,900

Baseline VOC emissions = 1,900 Mg/yr  
 Total wastewater volume = 4,700 lpm  
 Total number wastewater streams = 190  
 TIC = Total Industry Control

TREATMENT, STORAGE, AND DISPOSAL FACILITIES RACT OPTIONS NATIONAL IMPACTS

Option description			VOC emission reduction (Mg/yr)	Percent VOC emission reduction	Percent wastewater flow controlled	Percent wastewater stream controlled	Total capital cost (MM\$)	Total annual cost (MM\$/yr)	Average cost effectiveness (\$/Mg)
VO concentration cutoff (ppmw)	Flow rate cutoff (lpm)	Maximum VO Concentration (ppmw)							
1,000	10	10,000	1,900	61%	9%	18%	3.3	1.7	870
500	10	10,000	1,900	61%	9%	18%	3.3	1.7	870
1,000 <sup>a</sup>	1	10,000	1,900	61%	9%	19%	3.5	1.7	910
500	1	10,000	1,900	61%	9%	20%	3.7	1.8	940
200	1	10,000	2,000	63%	14%	24%	5.2	2.6	1,300
100	1	10,000	2,000	65%	24%	39%	8.3	4.3	2,100
TIC			2,100	66%	100%	100%	22	13	6,200

Baseline VOC emissions = 3,100 Mg/yr  
 Total wastewater volume = 15,000 lpm  
 Total number wastewater streams = 40  
 TIC = Total Industry Control

<sup>a</sup>Previously reported as the 1,000 ppmw/10 lpm option in the CTG document on page B-59.

**PHARMACEUTICALS SUBCATEGORY C (CHEMICAL SYNTHESIS)  
RACT OPTIONS NATIONAL IMPACTS**

Option description			VOC emission reduction (Mg/yr)	Percent VOC emission reduction	Percent wastewater flow controlled	Percent wastewater stream controlled	Total capital cost (MM\$)	Total annual cost (MM\$/yr)	Average cost effectiveness (\$/Mg)
VOC concentration cutoff (ppmw)	Flow rate cutoff (lpm)	Maximum VOC concentration (ppmw)							
1,000	10	10,000	15,600	74%	18%	35%	27	11	720
1,000	1	10,000	15,800	75%	18%	40%	27	11	730
500	10	10,000	15,900	76%	19%	42%	27	11	680
500	1	10,000	16,000	76%	20%	47%	27	11	680
200	1	10,000	17,000	82%	51%	62%	43	20	1,200
100	1	10,000	17,000	82%	51%	62%	43	20	1,200
TIC			17,500	83%	100%	100%	65	38	2,100

Baseline VOC emissions = 21,000 Mg/yr  
 Total wastewater volume = 53,000 lpm  
 Total number wastewater streams = 500  
 TIC = Total Industry Control

