

Final Risk Evaluation for Carbon Tetrachloride

Supplemental Information on Releases and Occupational Exposure Assessment

CASRN: 56-23-5

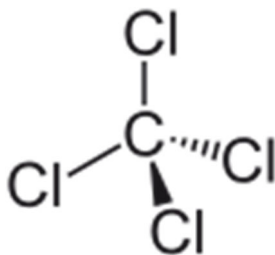

October 2020

TABLE OF CONTENTS

ABBREVIATIONS	7
EXECUTIVE SUMMARY	9
1 INTRODUCTION	11
1.1 Overview	11
1.2 Scope	11
1.3 General Approach and Methodology for Occupational Exposures	16
1.3.1 Process Description and Worker Activities	16
1.3.2 Number of Workers and Occupational Non-Users.....	16
1.3.3 Inhalation Exposure Assessment Approach and Methodology	17
1.3.3.1 General Approach.....	17
1.3.3.2 Approach for this Risk Evaluation	18
1.3.4 Dermal Exposure Assessment Approach and Methodology	19
1.3.5 Environmental Release Assessment Approach and Methodology	19
2 ENGINEERING ASSESSMENT	20
2.1 Domestic Manufacturing.....	20
2.1.1 Process Description	20
2.1.2 Exposure Assessment	20
2.1.2.1 Worker Activities	20
2.1.2.2 Number of Potentially Exposed Workers.....	21
2.1.2.3 Occupational Exposure Results.....	23
2.2 Import and Repackaging	25
2.2.1 Process Description	25
2.2.2 Exposure Assessment	26
2.2.2.1 Worker Activities	26
2.2.2.2 Number of Potentially Exposed Workers.....	26
2.2.2.3 Occupational Exposure Results.....	27
2.3 Processing as a Reactant or Intermediate.....	29
2.3.1 Process Description	29
2.3.2 Exposure Assessment	29
2.3.2.1 Worker Activities	29
2.3.2.2 Number of Potentially Exposed Workers.....	30
2.3.2.3 Occupational Exposure Assessment Methodology	31
2.3.2.3.1 Inhalation Exposure Assessment Results Using Monitoring Data	31
2.3.2.3.2 Inhalation Exposure Assessment Results Using Surrogate Data	32
2.4 Incorporation into Formulation, Mixture, or Reaction Product	34
2.5 Specialty Uses – Aerospace Industry	34
2.6 Specialty Uses - Department of Defense Data	35
2.6.1 Data Overview	35
2.6.2 OBOD Clean-Up Process Description.....	36
2.6.3 Exposure Assessment	36
2.7 Reactive Ion Etching	37
2.7.1 Process Description	37

2.7.2	Exposure Assessment	37
2.7.2.1	Worker Activities	38
2.7.2.2	Number of Potentially Exposed Workers.....	38
2.8	Industrial Processing Agent/Aid	38
2.8.1	Process Description	39
2.8.2	Exposure Assessment	40
2.8.2.1	Worker Activities	40
2.8.2.2	Number of Potentially Exposed Workers.....	40
2.8.2.3	Occupational Exposure Assessment Methodology	41
2.8.2.4	Occupational Exposure Results.....	42
2.9	Additive.....	42
2.9.1	Process Description	42
2.9.1	Exposure Assessment	42
2.9.1.1	Worker Activities	42
2.9.1.2	Number of Potentially Exposed Workers.....	42
2.9.1.3	Occupational Exposure Assessment Methodology	43
2.9.1.4	Occupational Exposure Results.....	43
2.10	Laboratory Chemicals	43
2.10.1	Process Description	43
2.10.2	Exposure Assessment	44
2.10.2.1	Worker Activities	44
2.10.2.2	Number of Potentially Exposed Workers.....	44
2.11	Disposal/Recycling.....	45
2.11.1	Process Description	45
2.11.2	Exposure Assessment	49
2.11.2.1	Worker Activities	49
2.11.2.2	Number of Potentially Exposed Workers.....	50
2.11.2.3	Occupational Exposure Assessment Methodology	51
2.11.2.4	Occupational Exposure Results.....	51
2.12	Dermal Exposure Assessment.....	51
2.13	Summary of Occupational Exposure Assessment.....	54
3	DISCUSSION OF UNCERTAINTIES AND LIMITATIONS	56
3.1	Variability.....	56
3.2	Uncertainties and Limitations	56
3.2.1	Number of Workers	56
3.2.2	Analysis of Exposure Monitoring Data	56
3.2.1	Modeling Inhalation Exposures.....	57
3.2.1.1	Tank Truck and Railcar Loading and Unloading Release and Inhalation Exposure Model	57
3.2.2	Modeling Dermal Exposures	58
	REFERENCES.....	59
	APPENDICES.....	63
	Appendix A Approach for Estimating Number of Workers and Occupational Non-Users	63

Appendix B Equations for Calculating Chronic (Non-Cancer and Cancer) Inhalation Exposures	68
B.1 Exposure Duration (ED)	69
B.2 Exposure Frequency (EF)	69
B.3 Working Years (WY)	70
B.4 Lifetime Years (LT)	72
Appendix C Sample Calculations for Calculating Acute and Chronic (Non-Cancer and Cancer) Inhalation Exposures	73
C.1 Example High-End ADC and LADC	73
C.2 Example Central Tendency ADC and LADC	73
Appendix D Tank Truck and Railcar Loading and Unloading Release and Inhalation Exposure Model Methodology	75
D.1 Displacement of Saturated Air Inside Tank Trucks and Railcars	75
D.2 Emissions of Saturated Air that Remain in Transfer Hoses/Loading Arm	76
D.3 Emission from Leaks	78
D.4 Exposure Estimates	81
Appendix E Dermal Exposure Assessment Approach and Parameters	84
E.1 Incorporating the Effects of Evaporation	84
E.1.1 Modification of EPA/OPPT Models	84
E.2 Calculation of f_{abs}	84
E.2.1 Small Doses (Case 1: $M_0 \leq M_{sat}$)	85
E.2.2 Large Doses (Case 2: $M_0 > M_{sat}$)	86
E.3 Comparison of f_{abs} to FR_{abs} in the Consumer Exposure Model (CEM)	87
E.4 Comparison of f_{abs} to Experimental Values for Highly Volatile Chemicals	89
E.5 Potential for Occlusion	89
E.6 Incorporating Glove Protection	90
E.7 Proposed Dermal Dose Equation	91
E.8 Equations for Calculating Acute and Chronic (Non-Cancer and Cancer) Dermal Doses	92

LIST OF TABLES

Table 1-1. Crosswalk of Subcategories of Use Listed in the Problem Formulation Document to Conditions of Use Assessed in the Risk Evaluation	13
Table 2-1. Estimated Number of Workers Potentially Exposed to Carbon Tetrachloride During Manufacturing.....	22
Table 2-2. Summary of Worker Inhalation Exposure Monitoring Data for Manufacture of Carbon Tetrachloride	23
Table 2-3. Summary of ONU Inhalation Exposure Monitoring Data for Manufacture of Carbon Tetrachloride	24
Table 2-4. Estimated Number of Workers Potentially Exposed to Carbon Tetrachloride During Import and Repackaging.....	27
Table 2-5. Summary of Exposure Results for Import and Repackaging	28
Table 2-6. Estimated Number of Workers Potentially Exposed to Carbon Tetrachloride During Processing as a Reactant	31
Table 2-7. Summary of Inhalation Exposure Monitoring Data for Use as a Reactant for Carbon Tetrachloride.....	32
Table 2-8. Summary of Surrogate Data Results for Processing as a Reactant	32
Table 2-9. Summary of Surrogate ONU Inhalation Exposure Monitoring Data for Processing as a Reactant.....	33
Table 2-10. DOD Inhalation Monitoring Results	35
Table 2-11. Summary of Worker Inhalation Exposure Monitoring Data for Specialty Use of Carbon Tetrachloride	37
Table 2-12. Estimated Number of Workers Potentially Exposed to Carbon Tetrachloride During Use as a RIE	38
Table 2-13. List of Uses of Carbon Tetrachloride as Process Agents in MP Side Agreement, Decision X/14: Process Agents.....	39
Table 2-14. Estimated Number of Workers Potentially Exposed to Carbon Tetrachloride During Use as a Processing Agent/Aid	41
Table 2-15. Estimated Number of Workers Potentially Exposed to Carbon Tetrachloride when used as an Additive.....	43
Table 2-16. Estimated Number of Workers Potentially Exposed to Carbon Tetrachloride During Use as a Laboratory Chemical	45
Table 2-17. Estimated Number of Workers Potentially Exposed to Carbon Tetrachloride During Waste Handling.....	51
Table 2-18. Glove Protection Factors for Different Dermal Protection Strategies.....	52
Table 2-19. Estimated Dermal Retained Dose (mg/day) for Workers in All Conditions of Use	54
Table 2-20. Summary of Occupational Exposure Assessment for Workers	55

LIST OF FIGURES

Figure 2-1. General Process Flow Diagram for Import and Repackaging	26
Figure 2-2. General Laboratory Use Process Flow Diagram.....	44
Figure 2-3. Typical Waste Disposal Process	46
Figure 2-4. Typical Industrial Incineration Process.....	48
Figure 2-5. General Process Flow Diagram for Solvent Recovery Processes.....	49

LIST OF APPENDIX TABLES

Table_Apx A-1. SOCs with Worker and ONU Designations for All Conditions of Use Except Dry Cleaning	64
Table_Apx A-2. SOCs with Worker and ONU Designations for Dry Cleaning Facilities	65
Table_Apx A-3. Estimated Number of Potentially Exposed Workers and ONUs under NAICS 81232066	66
Table_Apx B-1. Parameter Values for Calculating Inhalation Exposure Estimates	69
Table_Apx B-2. Overview of Average Worker Tenure from U.S. Census SIPP (Age Group 50+)	71
Table_Apx B-3. Median Years of Tenure with Current Employer by Age Group	72
Table_Apx D-1. Example Dimension and Volume of Loading Arm/Transfer System	77
Table_Apx D-2. Default Values for Calculating Emission Rate of Carbon Tetrachloride from Transfer/Loading Arm	78
Table_Apx D-3. Parameters for Calculating Emission Rate of Carbon Tetrachloride from Equipment Leaks	79
Table_Apx D-4. Default Values for F_A and N	80
Table_Apx D-5. Parameters for Calculating Exposure Concentration Using the EPA/OPPT Mass Balance Model	82
Table_Apx D-6. Calculated Emission Rates and Resulting Exposures from the Tank Truck and Railcar Loading and Unloading Release and Inhalation Exposure Model for Carbon Tetrachloride	83
Table_Apx E-1. Estimated Fraction Evaporated and Absorbed (fabs) using Equation_Apx E-8.....	87
Table_Apx E-2. Exposure Control Efficiencies and Protection Factors for Different Dermal Protection Strategies from ECETOC TRA v3	91
Table_Apx E-3. Carbon Tetrachloride Parameter Values Used to Calculate Acute or Chronic Exposure Estimates	94
Table_Apx E-4. Overview of Average Worker Tenure from U.S. Census SIPP (Age Group 50+)	96
Table_Apx E-5. Median Years of Tenure with Current Employer by Age Group.....	97

LIST OF APPENDIX FIGURES

Figure_Apx D-1. Illustration of Transfer Lines Used During Tank Truck Unloading and Associated Equipment Assumed by EPA.....	81
Figure_Apx E-1. Estimated Fraction Absorbed for Highly Volatile Chemicals (CEM Equation)	88

ABBREVIATIONS

AC	Acute Concentration
ACGIH	American Conference of Government Industrial Hygienists
ADC	Average Daily Concentration
AIA	Aerospace Industries Association
AIHA	American Industrial Hygiene Association
AM	Arithmetic Mean
ATSDR	Agency for Toxic Substances and Disease Registries
BLS	Bureau of Labor Statistics
CAA	Clean Air Act
CBI	Confidential Business Information
CCl ₄	Carbon Tetrachloride
CDR	Chemical Data Reporting
CFC	Chlorofluorocarbon
cm ²	Square Centimeter(s)
cm ³	Cubic Centimeter(s)
CPS	Current Population Survey
CPSC	Consumer Product Safety Commission
CS ₂	Carbon Disulfide
CSM	Chlorosulphonated polyolefin
CT	Central Tendency
CWA	Clean Water Act
DOD	Department of Defense
EDC	Ethylene dichloride
EPA	Environmental Protection Agency
ESD	Emission scenario documents
g	gram(s)
GM	Geometric mean
GS	Generic scenario
HCFC	Hydrochlorofluorocarbon
HCl	Hydrochloric Acid
HE	High-end
HFC	Hydrofluorocarbon
HFO	Hydrofluoroolefin
HHE	Health Hazard Evaluation
HSIA	Halogenated Solvents Industry Alliance
HVLP	High Volume, Low Pressure
IBC	Intermediate Bulk Containers
kg	Kilogram(s)
L	Liter(s)
LADC	Lifetime Average Daily Concentration
lb	Pound
LOD	Limit of Detection
m ³	Cubic Meter(s)
mg	Milligram(s)
MP	Montreal Protocol
MEMA	Motor and Equipment Manufacturer Association

MW	Molecular Weight
MWC	Municipal Waste Combustor
NAICS	North American Industry Classification System
NCl ₃	Nitrogen Trichloride
ND	Non-Detected
NIOSH	National Institute for Occupational Safety and Health
NPDES	National Pollutant Discharge Elimination System
OARS	Occupational Alliance for Risk Science
OAQPS	Office of Air Quality Planning and Standards
ODS	Ozone Depleting Substance
OECD	Organisation for Economic Co-operation and Development
OEL	Occupational Exposure Limit
OES	Occupational Employment Statistics
ONU	Occupational Non-Users
OPPT	Office of Pollution Prevention and Toxics
OSHA	Occupational Safety and Health Administration
PCE	Perchloroethylene
PEL	Permissible Exposure Limit
PF	Protection Factor
POTW	Publicly Owned Treatment Works
PPE	Personal Protective Equipment
ppm	part(s) per million
QC	Quality Control
RCRA	Resource Conservation and Recovery Act
RDF	Refuse-Derived Fuel
REL	Recommended Exposure Limit
RFI	Reporting Forms and Instructions
RIE	Reactive Ion Etching
s	second(s)
SDWA	Safe Drinking Water Act
SIPP	Survey of Income and Program Participation
SOC	Standard Occupational Classification
SUSB	Statistics of US Businesses
T	Temperature
TCLP	Toxicity Characteristic Leaching Procedure
TLV	Threshold Limit Value
TRI	Toxic Release Inventory
TSCA	Toxic Substances Control Act
TSDF	Treatment, Storage and Disposal Facilities
TWA	Time-weighted Average
UNEP	United Nations Environment Programme
U.S.	United States
WEEL	Workplace Environmental Exposure Limit

EXECUTIVE SUMMARY

The Toxic Substances Control Act, TSCA § 6(b)(4) requires the United States Environmental Protection Agency (U.S. EPA) to establish a risk evaluation process. In performing risk evaluations for existing chemicals, EPA is directed to “determine whether a chemical substance presents an unreasonable risk of injury to health or the environment, without consideration of costs or other non-risk factors, including an unreasonable risk to a potentially exposed or susceptible subpopulation identified as relevant to the risk evaluation by the Administrator under the conditions of use.” In December of 2016, EPA published a list of 10 chemical substances that are the subject of the Agency’s initial chemical risk evaluations (81 FR 91927), as required by TSCA § 6(b)(2)(A). Carbon tetrachloride (CCl₄) was one of these chemicals.

CCl₄ is a colorless liquid with a sweet, aromatic and ethereal odor resembling chloroform and is subject to federal and state regulations and reporting requirements. In 1970, the Consumer Product Safety Commission (CPSC) banned the use of CCl₄ in consumer products (excluding unavoidable residues not exceeding 10 ppm atmospheric concentration). Effective January 1, 1987, CCl₄ became a Toxics Release Inventory (TRI)-reportable substance and in the same year was listed as an ozone depleting substance (ODS) under the Montreal Protocol (MP). The MP and Title VI of the Clean Air Act (CAA) Amendments of 1990 led to a phase-out of CCl₄ production in the United States for most non-feedstock domestic uses by 1996. Currently, carbon tetrachloride is used as a feedstock in the production of hydrochlorofluorocarbons (HCFCs), hydrofluorocarbons (HFCs) and hydrofluoroolefins (HFOs). The use of carbon tetrachloride for non-feedstock uses (i.e., process agent, additive) is regulated in accordance with the MP.

Focus of this Risk Evaluation

During scoping and problem formulation, EPA considered all known TSCA uses for CCl₄. CCl₄ has been manufactured and imported in the U.S. in large volumes with the most recently available data from the 2016 Chemical Data Reporting (CDR) indicating approximately 143 million pounds were either manufactured or imported in the U.S. in 2015. Domestic production and importation of CCl₄ is currently prohibited under regulations implementing the MP and CAA Title VI, except when transformed (used and entirely consumed, except for trace quantities, in the manufacture of other chemicals for commercial purposes), destroyed (including destruction after use as a catalyst or stabilizer), or used for essential laboratory and analytical uses (See 40 CFR Part 82; see also 60 FR 24970, 24971 (May 10, 1995)). Based on information obtained by EPA, there are no approved consumer uses for CCl₄. There are current regulatory actions that prohibit the direct use of CCl₄ as reactant or additive in the formulation of commercially available products for industrial/commercial/consumer uses (including aerosol and non-aerosol adhesives/sealants, paints/coatings, and cleaning/degreasing solvent products), besides as a laboratory chemical. The use of CCl₄ (and mixtures containing it) in household products has also been banned by CPSC since 1970, with the exception of “unavoidable manufacturing residues of CCl₄ in other chemicals that under reasonably foreseen conditions of use do not result in an atmospheric concentration of CCl₄ greater than 10 parts per million.” (16 CFR 1500.17(a)(2)).

Workers and occupational non-users may be exposed to CCl₄ during conditions of use such as manufacturing, import, processing, distribution, repackaging, and disposal/recycling.

Risk Evaluation Approach

EPA evaluated chronic exposures to workers and occupational non-users in association with CCl₄ conditions of use. EPA used inhalation monitoring data from literature sources. EPA used modeling

approaches to estimate dermal exposures. EPA used release data from literature sources where available and used modeling approaches where release data were not available.

Uncertainties of this Risk Evaluation

There are a number of uncertainties associated with the monitoring and modeling approaches used to assess CCl₄ exposures and releases. For example, the sites used to collect exposure monitoring data were not selected randomly, and the data reported therein may not be representative of all exposure scenarios. Further, of necessity, modeling approaches employed knowledge-based assumptions that may not apply to all use scenarios. Because site-specific differences in use practices and engineering controls exist, but are largely unknown, this represents another source of variability that EPA could not quantify in the assessment.

Human Populations Considered in this Risk Evaluation

EPA assessed risks for chronic exposure scenarios in workers (those directly handling CCl₄) and occupational non-users (workers not directly involved with the use of CCl₄) for CCl₄ in the uses outlined under *Focus of this Risk Evaluation*. EPA assumed that workers and occupational non-users would be individuals of both sexes (age 16 years and older, including pregnant workers) based upon occupational work permits, although exposures to younger workers in occupational settings cannot be ruled out.

1 INTRODUCTION

1.1 Overview

The Toxic Substances Control Act, TSCA § 6(b)(4), requires the United States Environmental Protection Agency (U.S. EPA) to establish a risk evaluation process. In performing risk evaluations for existing chemicals, EPA is directed to “determine whether a chemical substance presents an unreasonable risk of injury to health or the environment, without consideration of costs or other non-risk factors, including an unreasonable risk to a potentially exposed or susceptible subpopulation identified as relevant to the risk evaluation by the Administrator under the conditions of use.” In December of 2016, EPA published a list of 10 chemical substances that are the subject of the Agency’s initial chemical risk evaluations (81 FR 91927), as required by TSCA § 6(b)(2)(A). Carbon tetrachloride (CCl₄) was one of these chemicals.

CCl₄ is a colorless liquid with a sweet, aromatic and ethereal odor resembling chloroform and is subject to federal and state regulations and reporting requirements. In 1970, the Consumer Product Safety Commission (CPSC) banned the use of CCl₄ in consumer products (excluding unavoidable residues not exceeding 10 ppm atmospheric concentration). Effective January 1, 1987, CCl₄ became a Toxics Release Inventory (TRI)-reportable substance and in the same year was listed as an ozone depleting substance (ODS) under the Montreal Protocol (MP). The MP and Title VI of the Clean Air Act (CAA) Amendments of 1990 led to a phase-out of CCl₄ production in the United States for most non-feedstock domestic uses by 1996. Currently, carbon tetrachloride is used as a feedstock in the production of hydrochlorofluorocarbons (HCFCs), hydrofluorocarbons (HFCs) and hydrofluoroolefins (HFOs). The use of carbon tetrachloride for non-feedstock uses (i.e., process agent, additive) is regulated in accordance with the MP.

1.2 Scope

Workplace exposures and releases have been assessed for the following industrial and commercial uses of CCl₄:

1. Manufacturing;
2. Import and Repackaging;
3. Reactant/Intermediate;
4. Incorporation into Formulation;
5. Specialty Uses - Aerospace Industry;
6. Reactive Ion Etching;
7. Inert Solvent, Processing agent/aid;
8. Additive; and
9. Disposal/Waste Handling.

For work place exposures, EPA considered exposures to both workers who directly handle CCl₄ and occupational non-users (ONUs) who do not directly handle CCl₄ but may be exposed to vapors or mists that enter their breathing zone while working in locations in close proximity to where CCl₄ is being used. Although EPA considered both ONU and worker exposures, no data was found to estimate ONU exposures for any of the conditions of use.

The assessed conditions of use were described in Table 2-3 of the *Problem Formulation of the Risk Evaluation for Carbon Tetrachloride (Methane, Tetrachloro-)* (Problem Formulation Document) ([U.S. EPA, 2018c](#)); however, due to expected similarities in both processes and exposures/releases several of the subcategories of use in Table 2-3 were grouped and assessed together during the risk evaluation process. A crosswalk of the conditions of use in Table 2-3 to the conditions of use assessed in this report is provided in Table 1-1.

Table 1-1. Crosswalk of Subcategories of Use Listed in the Problem Formulation Document to Conditions of Use Assessed in the Risk Evaluation

Life Cycle Stage	Category ¹	Subcategory ^{2b}	Assessed Condition of Use
Manufacture	Domestic manufacture	Domestic manufacture	Domestic Manufacturing (Section 2.1)
	Import	Import	Import and Repackaging (Section 2.2)
Processing	Processing as a reactant/intermediate	Hydrochlorofluorocarbons (HCFCs), Hydrofluorocarbon (HFCs) and Hydrofluoroolefin (HFOs)	Processing as a Reactant or Intermediate (Section 2.3)
		Perchloroethylene (PCE)	
		Reactive ion etching (i.e., semiconductor manufacturing)	Reactive Ion Etching (Section 2.7)
	Incorporation into Formulation, Mixture or Reaction products	Petrochemicals-derived manufacturing; Agricultural products manufacturing; Other basic organic and inorganic chemical manufacturing.	Incorporation into Formulation, Mixture, or Reaction Product (Section 2.4)
	Processing - repackaging	Laboratory Chemicals	Import and Repackaging (Section 2.2) ³
	Recycling	Recycling	Disposal/Recycling (Section 2.11)

¹ These categories of conditions of use appear in the Life Cycle Diagram, reflect CDR codes and broadly represent conditions of use of carbon tetrachloride in industrial and/or commercial settings.

² These subcategories reflect more specific uses of carbon tetrachloride.

³ Repackaging is assessed, but not specifically for the use of laboratory chemicals

Life Cycle Stage	Category ¹	Subcategory ^{2b}	Assessed Condition of Use
Distribution in commerce	Distribution	Distribution in commerce	Activities related to distribution (e.g., loading, unloading) are considered throughout the life cycle, rather than using a single distribution scenario
Industrial/commercial use	Petrochemicals-derived products manufacturing	Processing aid	Industrial Processing Agent/Aid (Section 2.8)
		Additive	Additive (Section 2.9)
	Agricultural products manufacturing	Processing aid	Industrial Processing Agent/Aid (Section 2.8)
	Other Basic Organic and Inorganic Chemical Manufacturing	Manufacturing of chlorinated compounds used in solvents for cleaning and degreasing	Processing as a Reactant or Intermediate (Section 2.3)
	Other Basic Organic and Inorganic Chemical Manufacturing	Manufacturing of chlorinated compounds used in adhesives and sealants	Processing as a Reactant or Intermediate (Section 2.3)
	Other Basic Organic and Inorganic Chemical Manufacturing	Manufacturing of chlorinated compounds used in paints and coatings	Processing as a Reactant or Intermediate (Section 2.3)
	Other Basic Organic and Inorganic Chemical Manufacturing	Manufacturing of inorganic chlorinated compounds (i.e., elimination of nitrogen trichloride in the production of chlorine and caustic)	Processing as a Reactant or Intermediate (Section 2.3)
	Other Basic Organic and Inorganic Chemical Manufacturing	Manufacturing of chlorinated compounds used in asphalt	Processing as a Reactant or Intermediate (Section 2.30)

Life Cycle Stage	Category ¹	Subcategory ^{2b}	Assessed Condition of Use
	Other Basic Organic and Inorganic Chemical Manufacturing	Manufacturing of organic and inorganic chemical	Industrial Processing Agent/Aid (Section 2.8)
	Other uses	Processing aid (i.e., metal recovery).	Industrial Processing Agent/Aid (Section 2.8)
		Specialty uses (i.e., aerospace industry)	Specialty Uses – Aerospace Industry (Section 2.5) Specialty Uses – Department of Defense Data (Section 2.6)
	Laboratory chemicals	Laboratory chemical	Laboratory Chemicals (Section 2.10)
Disposal	Disposal	Industrial pre-treatment	Disposal/Recycling (Section 2.11) ⁴
		Industrial wastewater treatment	
		Publicly owned treatment works (POTW)	
		Underground injection	
		Municipal landfill	
		Hazardous landfill	
		Other land disposal	
		Municipal waste incinerator	
		Hazardous waste incinerator	
		Off-site waste transfer	

⁴ Each of the conditions of use of CCl₄ may generate waste streams of the chemical that are collected and transported to third-party sites for disposal, treatment, or recycling. Industrial sites that treat, dispose, or directly discharge onsite wastes that they themselves generate are assessed in each condition of use assessment. This section only assesses wastes of CCl₄ that are generated during a condition of use and sent to a third-party site for treatment, disposal, or recycling.

1.3 General Approach and Methodology for Occupational Exposures

The occupational exposure assessment of each condition of use comprises the following components:

- **Process Description:** A description of the condition of use, including the role of the chemical in the use; process vessels, equipment, and tools used during the condition of use;
- **Worker Activities:** Descriptions of the worker activities, including an assessment for potential points of worker exposure and environmental releases.
- **Number of Workers and Occupational Non-Users:** An estimate of the number of sites, number of workers and occupational non-users potentially exposed to the chemical for the given condition of use.
- **Inhalation Exposure:** Central tendency and high-end estimates of inhalation exposure to workers and occupational non-users. See Section 1.3.3 for a discussion of EPA's statistical analysis approach for assessing inhalation exposure.

In addition to the above components for each condition of use, a separate dermal exposure section is included that provides estimates of the dermal exposures for all the assessed conditions of use.

1.3.1 Process Description and Worker Activities

EPA performed a literature search to find descriptions of processes involved in each condition of use to identify worker activities that could potentially result in occupational exposures. Where process descriptions were unclear or not available, EPA referenced relevant emission scenario documents (ESDs) or generic scenarios (GSs). Process descriptions for each condition of use can be found in the applicable subsections of Engineering Assessment 2.

1.3.2 Number of Workers and Occupational Non-Users

Where available, EPA used CDR data to provide a basis to estimate the number of workers and ONUs. EPA supplemented the available CDR data with U.S. economic data using the following method:

1. Identify the North American Industry Classification System (NAICS) codes for the industry sectors associated with these uses.
2. Estimate total employment by industry/occupation combination using the Bureau of Labor Statistics' Occupational Employment Statistics (OES) data ([U.S. BLS, 2016](#)).
3. Refine the OES estimates where they are not sufficiently granular by using the U.S. Census' Statistics of US Businesses (SUSB) data on total employment by 6-digit NAICS ([U.S. Census Bureau, 2015](#)).
4. Use market penetration data to estimate the percentage of employees likely to be using CCl₄ instead of other chemicals. If no market penetration data were available, estimate of the number of sites using CCl₄ from given NAICS code and multiply by the estimated workers and ONUs/site provided in BLS data.
5. Where market penetration data are not available, use the estimated workers/ONUs per site in the 6-digit NAICS code and multiply by the number of sites estimated from CDR or TRI.
6. Combine the data generated in Steps 1 through 5 to produce an estimate of the number of employees using CCl₄ in each industry/occupation combination, and sum these to arrive at a total estimate of the number of employees with exposure.

1.3.3 Inhalation Exposure Assessment Approach and Methodology

1.3.3.1 General Approach

EPA provided occupational exposure results representative of *central tendency* conditions and *high-end* conditions. A central tendency is assumed to be representative of occupational exposures and environmental releases in the center of the distribution for a given condition of use. For risk evaluation, EPA may use the 50th percentile (median), mean (arithmetic or geometric), mode, or midpoint values of a distribution as representative of the central tendency scenario. EPA's preference is to provide the 50th percentile of the distribution. However, if the full distribution is not known, EPA may assume that the mean, mode, or midpoint of the distribution represents the central tendency depending on the statistics available for the distribution.

A high-end is assumed to be representative of occupational exposures that occur at probabilities above the 90th percentile but below the exposure of the individual with the highest exposure ([U.S. EPA, 1992](#)). For risk evaluation, EPA provided high-end results at the 95th percentile. If the 95th percentile is not available, EPA may use a different percentile greater than or equal to the 90th percentile but less than or equal to the 99.9th percentile, depending on the statistics available for the distribution. If the full distribution is not known and the preferred statistics are not available, EPA may estimate a maximum or bounding estimate in lieu of the high-end.

For occupational exposures, EPA may use measured or estimated air concentrations to calculate exposure concentration metrics required for risk assessment, such as average daily concentration and lifetime average daily concentration. These calculations require additional parameter inputs, such as years of exposure, exposure duration and frequency, and lifetime years. EPA may estimate exposure concentrations from monitoring data, modeling, or occupational exposure limits.

For the final exposure result metrics, each of the input parameters (e.g., air concentrations, working years, exposure frequency, lifetime years) may be a *point estimate* (i.e., a single descriptor or statistic, such as central tendency or high-end) or a *full distribution*. EPA will consider three general approaches for estimating the final exposure result metrics:

- **Deterministic calculations:** EPA will use combinations of point estimates of each parameter to estimate a central tendency and high-end for each final exposure metric result. EPA will document the method and rationale for selecting parametric combinations to be representative of central tendency and high-end.
- **Probabilistic (stochastic) calculations:** EPA will pursue Monte Carlo simulations using the full distribution of each parameter to calculate a full distribution of the final exposure metric results and selecting the 50th and 95th percentiles of this resulting distribution as the central tendency and high-end, respectively.
- **Combination of deterministic and probabilistic calculations:** EPA may have full distributions for some parameters but point estimates of the remaining parameters. For example, EPA may pursue Monte Carlo modeling to estimate exposure concentrations, but only have point estimates of working years of exposure, exposure duration and frequency, and lifetime years. In this case, EPA will document the approach and rationale for combining point estimates with distribution results for estimating central tendency and high-end results.

EPA follows the following hierarchy in selecting data and approaches for assessing inhalation exposures:

1. Monitoring data:
 - a. Personal and directly applicable
 - b. Area and directly applicable
 - c. Personal and potentially applicable or similar
 - d. Area and potentially applicable or similar
2. Modeling approaches:
 - a. Surrogate monitoring data
 - b. Fundamental modeling approaches
 - c. Statistical regression modeling approaches
3. Occupational exposure limits (OELs):
 - a. Company-specific OELs (for site-specific exposure assessments, e.g., there is only one manufacturer who provides to EPA their internal OEL but does not provide monitoring data)
 - b. OSHA PEL
 - c. Voluntary limits (ACGIH TLV, NIOSH REL, Occupational Alliance for Risk Science (OARS) workplace environmental exposure level (WEEL) [formerly by AIHA])

1.3.3.2 Approach for this Risk Evaluation

EPA reviewed workplace inhalation monitoring data collected by government agencies such as OSHA and NIOSH, monitoring data submitted by industry organizations through public comments, and monitoring data found in published literature (i.e., personal exposure monitoring data and area monitoring data). Studies were evaluated using the evaluation strategies laid out in the *Application of Systematic Review in TSCA Risk Evaluations* ([U.S. EPA, 2018a](#)).

Exposures are calculated from the datasets provided in the sources depending on the size of the dataset. For datasets with six or more data points, central tendency and high-end exposures were estimated using the 50th percentile and 95th percentile. For datasets with three to five data points, central tendency exposure was calculated using the 50th percentile and the maximum was presented as the high-end exposure estimate. For datasets with two data points, the midpoint was presented as a midpoint value and the higher of the two values was presented as a higher value. Finally, data sets with only one data point presented the value as a what-if exposure. For datasets including exposure data that were reported as below the limit of detection (LOD), EPA estimated the exposure concentrations for these data, following EPA's *Guidelines for Statistical Analysis of Occupational Exposure Data* ([U.S. EPA, 1994a](#)) which recommends using the $\frac{LOD}{\sqrt{2}}$ if the geometric standard deviation of the data is less than 3.0 and $\frac{LOD}{2}$ if the geometric standard deviation is 3.0 or greater. Specific details related to each condition of use can be found in Section 2. For each condition of use, these values were used to calculate chronic (non-cancer and cancer) exposures. Equations and sample calculations for chronic exposures can be found in Appendix B and Appendix C.

EPA used exposure monitoring data and exposure models to estimate inhalation exposures for all conditions of use. Specific details related to the use of monitoring data for each condition of use can be found in Section 2. Descriptions of the development and parameters used in the exposure models used for this assessment can be found in Appendix A through Appendix E.

1.3.4 Dermal Exposure Assessment Approach and Methodology

Dermal exposure data was not readily available for the conditions of use in the assessment. Because CCl₄ is a volatile liquid that readily evaporates from the skin, EPA estimated dermal exposures using the Dermal Exposure to Volatile Liquids Model. This model determines a dermal potential dose rate based on an assumed amount of liquid on skin during one contact event per day and the steady-state fractional absorption for CCl₄ based on a theoretical framework provided by Kasting and Miller ([Kasting and Miller, 2006](#)). The amount of liquid on the skin is adjusted by the weight fraction of CCl₄ in the liquid to which the worker is exposed. Specific details of the dermal exposure assessment can be found in Section 2.12 and equations and sample calculations for estimate dermal exposures can be found in Appendix E.

1.3.5 Environmental Release Assessment Approach and Methodology

CCl₄ environmental releases are not assessed in this risk evaluation because exposure from environmental releases are controlled under regulatory programs of other environmental statutes, administered by EPA, which adequately assess and effectively manage exposures, i.e., the CAA, the Safe Drinking Water Act (SDWA), the Clean Water Act (CWA) and the Resource Conservation and Recovery Act (RCRA). OPPT worked closely with the offices within EPA that administer and implement the regulatory programs under these statutes. In some cases, EPA has determined that chemicals present in various media pathways (i.e., air, water, land) fall under the jurisdiction of existing regulatory programs and associated analytical processes carried out under other EPA-administered statutes and have been assessed and effectively managed under those programs. EPA believes that the TSCA risk evaluation should generally focus on those exposure pathways associated with TSCA conditions of use that are not adequately assessed and effectively managed under the regulatory regimes discussed above because these pathways are likely to represent the greatest areas of risk concern. Section 2.5.3 of the problem formulation document outlines the rationale for excluding these exposure pathways from the risk evaluation. Therefore, the engineering assessment does not evaluate releases of CCl₄ to the environment ([U.S. EPA, 2018c](#)).

2 Engineering Assessment

The following sections contain process descriptions and the specific details (worker activities, analysis for determining number of workers, exposure assessment approach and results) from the assessment for each condition of use. EPA assessed the conditions of use as stated in the *Problem Formulation of the Risk Evaluation for Carbon Tetrachloride (Methane, Tetrachloro-)* published by EPA in May 2018 ([U.S. EPA, 2018c](#)).

2.1 Domestic Manufacturing

Domestic production of CCl₄ is currently prohibited under regulations implementing the MP and CAA Title VI, except when transformed (used and entirely consumed, except for trace quantities, in the manufacture of other chemicals for commercial purposes), destroyed (including destruction after use as a catalyst or stabilizer), or used for essential laboratory and analytical uses (40 CFR Part 82, 60 FR 24970, 24971 (May 10, 1995)) ([U.S. EPA, 2018c](#)). Therefore, once manufactured, the CCl₄ will be handled again either on-site or by another facility for the identified uses described in detail in the following sections.

2.1.1 Process Description

CCl₄ was previously produced solely through the chlorination of carbon disulfide (CS₂); however, in the 1950s chlorination of hydrocarbons became popular ([Holbrook, 2000](#)). Currently, most CCl₄ is manufactured using one of three methods: chlorination of hydrocarbons or chlorinated hydrocarbons; oxychlorination of hydrocarbons; or CS₂ chlorination ([Holbrook, 2000](#)).

Chlorination of hydrocarbons or chlorinated hydrocarbons - The chlorination of hydrocarbons involves a simultaneous breakdown of the organics and chlorination of the molecular fragments at pyrolytic temperatures and is often referred to as chlorinolysis ([Holbrook, 2000](#)). A variety of hydrocarbons and chlorinated hydrocarbon waste streams can be used as feedstocks; however, methane is the most common ([Holbrook, 2000](#)). Perchloroethylene (PCE) is formed as a major byproduct of this process with small volumes of hexachloroethane, hexachlorobutadiene and hexachlorobenzene also produced ([Holbrook, 2000](#)).

Oxychlorination of hydrocarbons - The oxychlorination of hydrocarbons involves the reaction of either chlorine or hydrochloric acid (HCl) and oxygen with a hydrocarbon feedstock in the presence of a catalyst ([Marshall and Pottenger, 2016](#); [Holbrook, 2000](#)). This process can be used to convert HCl produced as a byproduct during the manufacture of chlorinated hydrocarbons into useful products ([Marshall and Pottenger, 2016](#)).

CS₂ Chlorination - The chlorination of CS₂ involves the continuous reaction of CS₂ with chlorine in an annular reaction ([Holbrook, 2000](#)). The CCl₄ produced is distilled to have a CS₂ content of 0 to 5 ppm. This process produces disulfur dichloride as a byproduct that is reduced with hydrogen without a catalyst or with a ferric chloride catalyst ([Holbrook, 2000](#)).

2.1.2 Exposure Assessment

2.1.2.1 Worker Activities

During manufacturing, workers are primarily exposed while connecting and disconnecting hoses and transfer lines to containers and packaging to be loaded (e.g., railcars, tank trucks, totes, drums, bottles) and intermediate storage vessels (e.g., storage tanks, pressure vessels). Workers near loading racks and

container filling stations are potentially exposed to fugitive emissions from equipment leaks and displaced vapor as containers are filled. These activities are potential sources of worker exposure through dermal contact with liquid and inhalation of vapors.

ONUs include employees that work at the site where CCl₄ is manufactured, but they do not directly handle the chemical and are therefore expected to have lower inhalation exposures and are not expected to have dermal exposures. ONUs for manufacturing include supervisors, managers, and tradesmen that may be in the same area as exposure sources but do not perform tasks that result in the same level of exposures as workers.

2.1.2.2 Number of Potentially Exposed Workers

The 2016 CDR data reports nine sites that domestically manufacture CCl₄ ([U.S. EPA, 2016b](#)). Of the nine sites, one reported 0 lb of CCl₄ imported and 0 lb of CCl₄ manufactured for reporting year 2015 ([U.S. EPA, 2016b](#)). EPA/OPPT assumed manufacture and import of CCl₄ at this site has ceased and is not included in the worker estimation. Another entry reported 0 lb of CCl₄ manufactured for reporting year 2015 and will be assessed as import only. Therefore, there are a possible seven sites that domestically manufacture CCl₄.

EPA estimated the number of workers and occupational non-users potentially exposed to CCl₄ at manufacturing sites using 2016 CDR data, 2017 TRI data, Bureau of Labor Statistics' OES data (BLS Data) and the U.S. Census' SUSB (SUSB Data). The method for estimating number of workers from the Bureau of Labor Statistics' OES data and U.S. Census' SUSB data is detailed in Appendix A. These estimates were derived using industry- and occupation-specific employment data from the BLS and U.S. Census.

For each 2016 CDR submission, the reporter indicates the range of workers that estimates the number of total exposed workers. Six sites that reported domestic manufacture in CDR listed 100 to 500 exposed workers ([U.S. EPA, 2016b](#)). One site reported 25 to 50 exposed workers.

To calculate the number of workers and ONUs potentially exposed, EPA utilized BLS data and SUSB data to estimate the ratio of workers to ONUs based on the reported NAICS code and assumed the same ratio for the number of workers reported in CDR. EPA identified the NAICS code 325199, All Other Basic Organic Chemical Manufacturing, and 325180, Other Basic Inorganic Chemical Manufacturing, as the codes expected to include manufacturing sites ([U.S. EPA, 2017c](#)). Based on data from the BLS for NAICS code 325199 and related standard occupational classification (SOC) codes, there are an average of 39 workers and 18 ONUs per site, or a total of 57 potentially exposed workers and ONUs for sites under this NAICS code ([U.S. BLS, 2016](#)). Data from the BLS for NAICS code 325180 and related SOC codes identifies an average of 25 workers and 12 ONUs per site, or a total of 37 potentially exposed workers and ONUs for sites under this NAICS code ([U.S. BLS, 2016](#); [U.S. Census Bureau, 2015](#)).

As the CDR number of exposed workers are provided in ranges, EPA calculates both a high- and low-end estimate for the number of workers and ONUs exposed per site. To determine the high-end total number of workers and ONUs, EPA/OPPT used the high-end of ranges reported in the 2016 CDR ([U.S. EPA, 2016b](#)). EPA/OPPT used TRI reported primary NAICS codes where available and where not available assumed the NAICS code to be 325199. This resulted in 6 sites being classified under 325199 and 1 site under 325180. The CDR data does not differentiate between workers and ONUs; therefore,

EPA/OPPT assumed the ratio of workers to ONUs would be similar as determined in the BLS data where approximately 68% of the exposed personnel are workers and 32% are ONUs ([U.S. BLS, 2016](#); [U.S. Census Bureau, 2015](#)). This resulted in an estimated 2,100 workers and 980 ONUs (see Table 2-1). To determine the low-end total number of workers and ONUs, EPA/OPPT used the low-end of ranges reported in CDR and the worker-to-ONU ratio from the BLS data ([U.S. BLS, 2016](#));([U.S. EPA, 2016b](#)). This resulted in an estimated 430 workers and 200 ONUs (see Table 2-1).

Table 2-1. Estimated Number of Workers Potentially Exposed to Carbon Tetrachloride During Manufacturing

Number of Sites	Exposed Workers per Site	Exposed Occupational Non-Users per Site	Total Exposed Workers	Total Exposed Occupational Non-Users	Total Exposed
High-End					
5 ^a	340	160	1,700	800	2,500
1 ^a	340	160	340	160	500
1 ^b	34	16	34	16	50
<i>Total Exposed Workers and ONUs</i>			2,100 ^c	980 ^c	3,100 ^c
Low-End					
5 ^a	68	32	340	160	500
1 ^a	68	32	68	32	100
1 ^b	17	8	17	8	25
<i>Total Exposed Workers and ONUs</i>			430 ^c	200 ^c	630 ^c

^a Number of workers and occupational non-users per site estimated by taking the either 100 (low-end, per 2016 CDR) or 500 (high-end, per 2016 CDR) and multiplying by 68% and 32% for workers and ONUs, respectively. Values are rounded to the nearest integer.

^b Number of workers and occupational non-users per site estimated by taking the either 25 (low-end, per 2016 CDR) or 50 (high-end, per 2016 CDR) and multiplying by 68% and 32% for workers and ONUs, respectively. Values are rounded to the nearest integer.

^c Totals may not add properly due to rounding to two significant figures.

After review of 2017 TRI data, EPA discovered that multiple facilities that reported as a manufacturer in CDR submitted additional uses as a reactant or as a processing agent/aid ([U.S. EPA, 2017c, 2016b](#)). To properly analyze worker exposure without overestimation, the exposure from these submissions is accounted for in the manufacturing section because the data indicates that once CCl₄ is manufactured it is transferred through piping to another location at the same site into the appropriate process for use. EPA expects manufacturers to use piping systems that enclose the chemical and limit exposure to fugitive emissions from minor leaks. The manufacturer can also sell the CCl₄ as a product to be used elsewhere, and the exposures from those uses are captured and assessed in sections 2.4, 2.7, 2.9, and 2.10 below.

2.1.2.3 Occupational Exposure Results

EPA assessed inhalation exposures during manufacturing using identified monitoring data. Table 2-2 summarizes 8-hr and 12-hr TWA samples obtained from data submitted by the Halogenated Solvents Industry Alliance (HSIA) via public comment for two companies ([HSIA, 2019](#)). In addition to the data submitted by HSIA, EPA also identified data from a NIOSH investigation at a magnesium manufacturing site where CCl₄ is manufactured as a byproduct ([Kim et al., 2005](#)). However, the manufacture of CCl₄ as a byproduct is not expected to be representative of sites where CCl₄ is manufactured intentionally; therefore, the data was not considered in EPA’s assessment.

HSIA ([2019](#)) provided monitoring data for CCl₄ collected by two companies listed as “Company A” and “Company B”. The data were collected between 2005 and 2018 with full-shift data collected over 8 to 12 hours during which workers engaged in a variety of activities including collecting catch samples; performing filter changes; line and equipment opening; loading and unloading; process sampling; and transferring of hazardous wastes ([HSIA, 2019](#)). EPA assessed two exposure scenarios: 1) 8-hr TWA; 2) 12-hr TWA.

The discrete samples from companies A and B specified the sampling time for each data point ([HSIA, 2019](#)). EPA assessed an exposure duration of 8 hours (480 minutes) per day for averaging data points that specified sampling time between 390 minutes (6.5 hours) and 540 minutes (9 hours). If the sample time for a data point was less than 8 hours, EPA calculated the 8-hr TWA exposure assuming exposure to be zero outside the sampling time. EPA assessed an exposure duration of 12 hours (720 minutes) per day for averaging data points that specified sampling time between 540 minutes (9 hours) and 720 minutes (12 hours). Similar to 8-hr TWAs, where sample times were less than 12-hrs, EPA calculated the 12-hr TWA exposure assuming exposure to be zero outside the sampling time.

It should be noted that approximately 83% of the 8-hr TWA exposure data and 72% of the 12-hr TWA exposure data were below the LOD. Analysis showed that the geometric standard deviation for 8-hr TWA was less than 3.0, therefore, EPA assessed non-detectable data as $\frac{LOD}{\sqrt{2}}$ per the *Guidelines for Statistical Analysis of Occupational Exposure Data* ([U.S. EPA, 1994a](#)). For the 12-hr TWA data, the geometric standard deviation was greater than 3.0, therefore, EPA assessed the non-detectable data as $\frac{LOD}{2}$ ([U.S. EPA, 1994a](#)). Because over 50% of 8-hr and 12-hr TWA exposure data are below the LOD, calculating statistics from this data does present the potential to introduce biases into the results. Estimation of exposure values for results below the LOD may over- or under-estimate actual exposure thus skewing the calculated statistics higher or lower, respectively. The overall directional bias of the exposure assessment, accounting for both the overestimate and underestimate, is not known.

Table 2-2. Summary of Worker Inhalation Exposure Monitoring Data for Manufacture of Carbon Tetrachloride

Exposure Calculation	Number of Samples	Central Tendency (mg/m ³)	High-End (mg/m ³)	Confidence Rating of Associated Air Concentration Data
8-hr TWA Results				
Full-Shift TWA	113	0.76	4.0	Medium
Acute Concentration (AC)		0.76	4.0	

Exposure Calculation	Number of Samples	Central Tendency (mg/m ³)	High-End (mg/m ³)	Confidence Rating of Associated Air Concentration Data
Average Daily Concentration (ADC)		0.76	4.0	
Lifetime Average Daily Concentration (LADC)		0.07	0.47	
12-hr TWA Results				
Full-Shift TWA	243	0.50	4.8	Medium
AC		0.50	4.8	
ADC		0.50	4.8	
LADC		0.069	0.83	

ADC = Average Daily Concentration and LADC = Lifetime Average Daily Concentration. Equations and parameters for calculation of the ADC, and LADC are described in Appendix B.

Additional information was submitted by HSIA during the public comment period on the draft risk evaluation to specify that some of their submitted data were for ONU exposure ([HSIA, 2019](#)). HSIA reported that exposure data associated with the job title of process supervisors, utilities control board technicians, and electricians were considered ONUs. EPA incorporated the additional information and used it to evaluate ONU exposure during manufacture of carbon tetrachloride. Table 2-3 summarizes 8-hr and 12-hr TWA samples for ONU inhalation exposure monitoring data obtained from data submitted by the Halogenated Solvents Industry Alliance (HSIA) via public comment for two companies ([HSIA, 2019](#)).

Table 2-3. Summary of ONU Inhalation Exposure Monitoring Data for Manufacture of Carbon Tetrachloride

Exposure Calculation	Number of Samples	Central Tendency (mg/m ³)	High-End (mg/m ³)	Confidence Rating of Associated Air Concentration Data
8-hr TWA Results				
Full-Shift TWA	14	0.50	1.0	Medium
AC		0.50	1.0	
ADC		0.50	1.0	
LADC		0.046	0.12	
12-hr TWA Results				
Full-Shift TWA	3	0.66	1.3	Medium
AC		0.66	1.3	
ADC		0.66	1.3	
LADC		0.060	0.15	

Equations and parameters for calculation of the ADC, and LADC are described in Appendix B.

2.2 Import and Repackaging

Domestic production and importation of carbon tetrachloride is currently prohibited under regulations implementing the Montreal Protocol (MP) and CAA Title VI, except when transformed (used and entirely consumed, except for trace quantities, in the manufacture of other chemicals for commercial purposes), destroyed (including destruction after use as a catalyst or stabilizer), or used for essential laboratory and analytical uses. (40 CFR Part 82, 60 FR 24970, 24971 (May 10, 1995)) Therefore, once imported or manufactured, carbon tetrachloride will be handled again either on-site or by another facility for the identified uses described in detail in the following sections.

The import and repackaging scenario covers only those sites that purchase carbon tetrachloride from domestic and/or foreign suppliers and repack the carbon tetrachloride from bulk containers into smaller containers for resale. It does not include sites that import carbon tetrachloride and either: (1) store the chemical in a warehouse and resell directly without repackaging; (2) act as the importer of record for carbon tetrachloride but carbon tetrachloride is never present at the site⁵; or (3) import the chemical and process or use the chemical directly at the site. In case #1, there is little or negligible opportunity for exposures or releases as the containers are never opened. In case #2, the potential for exposure and release is at the site receiving carbon tetrachloride, not the “import” site and exposures/releases at the site receiving carbon tetrachloride are assessed in the relevant scenario based on the condition of use for carbon tetrachloride at the site. Similarly, for case #3, the potential for exposure and release at these sites are evaluated in the relevant scenario depending on the condition of use for carbon tetrachloride at the site.

2.2.1 Process Description

In general, commodity chemicals are imported into the United States in bulk via water, air, land, and intermodal shipments ([Tomer and Kane, 2015](#)). These shipments take the form of oceangoing chemical tankers, railcars, tank trucks, and intermodal tank containers. Chemicals shipped in bulk containers may be repackaged into smaller containers for resale, such as drums or bottles. Domestically manufactured commodity chemicals may be shipped within the United States in liquid cargo barges, railcars, tank trucks, tank containers, intermediate bulk containers (IBCs)/totes, and drums. Both imported and domestically manufactured commodity chemicals may be repackaged by wholesalers for resale; for example, repackaging bulk packaging into drums or bottles.

The exact shipping and packaging methods specific to CCl₄ are not known. For this risk evaluation, EPA assesses the repackaging of CCl₄ from bulk packaging to drums and bottles at wholesale repackaging sites (see Figure 2-1).

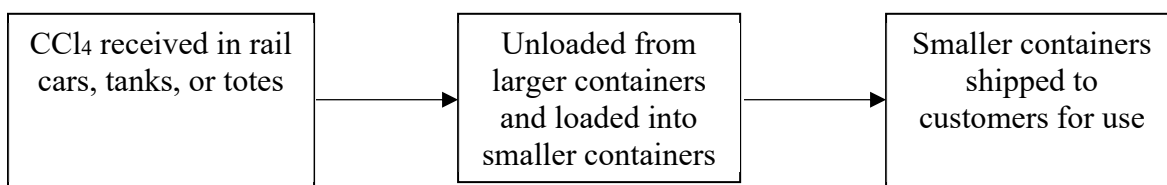

⁵ In CDR, the reporting site is the importer of record which may be a corporate site or other entity that facilitates the import of the chemical but never actually receives the chemical. Rather, the chemical is shipped directly to the site processing or using the chemical.

Figure 2-1. General Process Flow Diagram for Import and Repackaging

The import and repackage scenario is meant to include sites that receive CCl₄ from either a domestic or foreign (importer) supplier that then repackage CCl₄ prior to selling it to downstream users. Sites that import and use CCl₄ directly at the import site (e.g. import for use as an intermediate, processing aid, etc. at the site) are included in the assessment for the appropriate use scenario.

2.2.2 Exposure Assessment

2.2.2.1 Worker Activities

Based on EPA's knowledge of the chemical industry, worker activities at import and repackaging sites are potentially exposed while connecting and disconnecting hoses and transfer lines to containers and packaging to be unloaded (e.g., railcars, tank trucks, totes), intermediate storage vessels (e.g., storage tanks, pressure vessels), analyzing quality control (QC) samples, and final packaging containers (e.g., drums, bottles). Workers near loading racks and container filling stations are potentially exposed to fugitive emissions from equipment leaks and displaced vapor as containers are filled. These activities are potential sources of worker exposure through dermal contact with liquid and inhalation of vapors.

ONUs include employees that work at the site where CCl₄ is repackaged, but they do not directly handle the chemical and are therefore expected to have lower inhalation exposures and are not expected to have dermal exposures. ONUs for repackaging include supervisors, managers, and tradesmen that may be in the repackaging area but do not perform tasks that result in the same level of exposures as repackaging workers.

2.2.2.2 Number of Potentially Exposed Workers

EPA reviewed 2016 CDR data, 2017 TRI data, BLS Data and SUSB Data to determine the number of potentially exposed workers for importing and repacking of CCl₄. The method for estimating number of workers from the Bureau of Labor Statistics' OES data and U.S. Census' SUSB data is detailed in Appendix A. As described in Section 2.1.2.2, one site was determined to be an importing site. None of the CDR submissions reported a repackaging activity in the industrial processing and use section.

In the 2017 TRI data, one submission reported an import activity and one submission reported a repackaging activity. The site reporting import in the 2017 TRI also reported use of CCl₄ as a processing aid. This site is included in the assessment of use of CCl₄ as a processing aid (see Section 2.8). The TRI entry marked for repackaging has primary NAICS code 562211, Hazardous Waste Treatment and Disposal, and is most likely a waste disposal facility. Therefore, this site is included in the waste handling/recycling assessment (see Section 2.9) and not included in the import and repackaging assessment.

Based on the information reported in the 2016 CDR and 2017 TRI, EPA assesses one possible import/repackaging site for CCl₄ ([U.S. EPA, 2017c](#), [2016b](#)). EPA identified the NAICS code 424690, Other Chemical and Allied Products Merchant Wholesalers, as the code expected to include sites importing and repackaging CCl₄. EPA assesses the number of potentially exposed workers based on data from the BLS for NAICS code 424690 and related SOC codes. There is a total of one potentially exposed workers and one ONU for sites under this NAICS code (see Table 2-4) ([U.S. BLS, 2016](#); [U.S. Census Bureau, 2015](#)).

Table 2-4. Estimated Number of Workers Potentially Exposed to Carbon Tetrachloride During Import and Repackaging

Number of Sites	Exposed Workers per Site	Exposed Occupational Non-Users per Site	Total Exposed Workers	Total Exposed Occupational Non-Users	Total Exposed
1 ^a	1	1	1	1	2
<i>Total Exposed Workers and ONUs</i>			1	1	2

^a For the sites using values from the BLS analysis, the total number of workers and occupational non-users are calculated using the number of workers and occupational non-users per site estimated from BLS and multiplying by the number of sites. The number of workers and occupational non-users per site presented in the table round the values estimated from the BLS analysis to the nearest integer.

2.2.2.3 Occupational Exposure Results

EPA assessed inhalation exposures during the repackaging of CCl₄ using identified monitoring data submitted by the HSIA via public comment for two companies ([HSIA, 2019](#)). The data were previously discussed and presented in Section 2.1.2.3 for the assessment of worker exposure during manufacture of CCl₄. EPA identified 15 of the 356 submitted data points as listing worker activities for the unloading and/or loading of CCl₄ into tank trucks or railcars. EPA used these data to estimate exposures at repackaging facilities where the primary exposure activity is expected to be the unloading of CCl₄ from bulk containers into smaller containers. EPA assumed this unloading activity will result in exposures similar to unloading/loading activities at manufacturing sites. For this assessment, EPA only considered the 8-hr TWA data as information to substantiate 12-hr shifts at repackaging sites were not identified. Additionally, EPA only used data points if the worker activities were specifically for CCl₄ loading/unloading (those that listed other loading activities such as methyl chloride tank loading were not included).

EPA assessed the sample duration in the same manner as described in Section 2.1.2.3 in order to evaluate an 8-hr TWA. Data points that specified sampling time between 390 minutes (6.5 hours) and 540 minutes (9 hours) were averaged as an exposure duration of 8 hours (480 minutes) per day. If the sample time for a data point was less than 8 hours, EPA calculated the 8-hr TWA exposure assuming exposure to be zero outside the sampling time.

Approximately 60% of the 8-hr TWA exposure data identified for the unloading/loading of CCl₄ were below the LOD. Analysis showed that the geometric standard deviation for 8-hr TWA was less than 3.0, therefore, EPA assessed non-detectable data as LOD/ $\sqrt{2}$ per the *Guidelines for Statistical Analysis of Occupational Exposure Data* ([U.S. EPA, 1994a](#)). Estimation of exposure values for results below the LOD may over- or under-estimate actual exposure thus skewing the calculated statistics higher or lower, respectively. The overall directional bias of the exposure assessment, accounting for both the overestimate and underestimate, is not known.

EPA developed a Tank Truck and Railcar Loading and Unloading Release and Inhalation Exposure Model through the review of relevant literature and consideration of existing EPA exposure models. The purpose of this model is to supplement the assessment of conditions of use with limited or missing monitoring data where the primary emission source is from the transfer of CCl₄. The model estimates the potential concentration of CCl₄ in air when it is unloaded or loaded at an industrial facility. The model accounts for the displacement of saturated air containing the chemical of interest as the

container/truck is filled with liquid, emissions of saturated air containing the chemical of interest that remains in the loading arm, transfer hose and related equipment, and emissions from equipment leaks from processing units such as pumps, seals, and valves. Analysis of conservatively assuming CCl₄ is present at 100 percent concentration when imported or repackaged.

EPA calculated 8-hr TWA exposures to workers during loading activities identified through the submitted HSIA data and compared these to the Tank Truck and Railcar Loading and Unloading Release and Inhalation Exposure Model results. Table 2-5 presents a summary of the exposure results for the unloading and loading of CCl₄.

Table 2-5. Summary of Exposure Results for Import and Repackaging

Exposure Calculation	Number of Samples	Central Tendency (mg/m ³)	High-End (mg/m ³)	Confidence Rating of Associated Air Concentration Data
HSIA Surrogate Data				
Full-Shift TWA	15	0.89	2.9	Medium
AC		0.89	2.9	
ADC		0.89	2.9	
LADC		0.10	0.34	
Tank Truck and Railcar Loading and Unloading Release and Inhalation Exposure Model				
Full-Shift TWA	N/A – Modeled Data	0.057	0.30	N/A – Modeled Data
AC		0.057	0.30	
ADC		0.057	0.30	
LADC		0.0052	0.035	

Equations and parameters for calculation of the ADC, and LADC are described in Appendix B.

The model estimates the central tendency exposure of 0.057 mg/m³ 8-hr TWA and a high-end exposure of 0.30 mg/m³ 8-hr TWA. However, exposure results from the monitoring data from unloading and loading resulted in the central tendency exposure of 0.89 mg/m³ 8-hr TWA and a high-end exposure of 2.9 mg/m³ 8-hr TWA. Both the central tendency and high-end exposure calculations are an order of magnitude higher than those calculated from the model. This is likely because the model only accounts for exposures during a single loading/unloading event while the monitoring data may capture exposures from other sources including additional loading/unloading activities and a fugitive emissions from process equipment (e.g., valves, pumps, etc.).

2.3 Processing as a Reactant or Intermediate

2.3.1 Process Description

Processing as a reactant or intermediate is the use of CCl_4 as a feedstock in the production of another chemical product via a chemical reaction in which CCl_4 is consumed. In the past, CCl_4 was mainly used as feedstock for the manufacture of chlorofluorocarbons (CFCs) ([Marshall and Pottenger, 2016](#)). However, due to the discovery that CFCs contribute to stratospheric ozone depletion, the use of CFCs was phased-out by the year 2000 to comply with the Montreal Protocol ([Holbrook, 2000](#)). One of the primary CFC replacements was the HFCs. Most HFCs, do not require CCl_4 for their manufacture. However, CCl_4 is used as a feedstock to produce HFC-245fa and HFC-365mfc. The production of hydrofluorocarbons HFC-245fa and HFC-365mfc accounted for 71% and 23%, respectively, of total CCl_4 consumption in 2016 ([MacRoy, 2017](#)).

Currently, CCl_4 is used as a reactant to manufacture a variety of products in addition to HFCs, including HCFCs, HFOs, hydrochloric acid, vinyl chloride, ethylene dichloride (EDC), Perchloroethylene (PCE), chloroform, hafnium tetrachloride, thiophosgene, and methylene chloride ([Krock, 2017](#); [U.S. EPA, 2017b](#); [Marshall and Pottenger, 2016](#); [Weil et al., 2006](#); [Holbrook, 2004, 2003](#)). In the catoxid® catalytic oxidation process, CCl_4 is also reacted in order to manufacture anhydrous HCl ([Krock, 2017](#)). The specifics of the reaction process (e.g., use and types of catalysts, reaction temperature) vary depending on the product being produced; however, a typical reaction process involves unloading CCl_4 from containers and feeding into the reaction vessel(s), where CCl_4 either fully or partially reacts with other raw materials to form the final product. Following the reaction, the product may be purified to remove unreacted CCl_4 or other materials if needed.

CCl_4 is used in the manufacturing of other chlorinated compounds/solvents that may be subsequently added to commercially available products (i.e., solvents for cleaning/degreasing, adhesives/sealants, and paints/coatings). However, given the high volatility of CCl_4 and the extent of reaction and efficacy of the separation/purification process for purifying final products, EPA expects insignificant or unmeasurable concentrations of CCl_4 in the manufactured chlorinated substances in the commercially available products.

2.3.2 Exposure Assessment

2.3.2.1 Worker Activities

Similar to when manufacturing carbon tetrachloride, workers are potentially exposed while connecting and disconnecting hoses and transfer lines to containers and packaging to be unloaded (e.g., railcars, tank trucks, totes) and adding raw materials into intermediate storage vessels (e.g., storage tanks, pressure vessels) when processing carbon tetrachloride as a reactant. Workers near loading racks and container filling stations are potentially exposed to fugitive emissions from equipment leaks and displaced vapor as containers are filled. These activities are potential sources of worker exposure through dermal contact with liquid and inhalation of vapors.

ONUs include employees that work at the site where CCl_4 is reacted, but they do not directly handle the chemical and are therefore expected to have lower inhalation exposures and are not expected to have dermal exposures. ONUs for processing as a reactant include supervisors, managers, and tradesmen that may be in the same area as exposure sources but do not perform tasks that result in the same level of exposures as workers.

2.3.2.2 Number of Potentially Exposed Workers

EPA estimated the number of workers and occupational non-users potentially exposed to CCl₄ at sites processing CCl₄ as a reactant using 2016 CDR data, 2017 TRI data, BLS Data and SUSB Data. The method for estimating number of workers from the Bureau of Labor Statistics' OES data and U.S. Census' SUSB data is detailed in Appendix A. These estimates were derived using industry- and occupation-specific employment data from the BLS and U.S. Census. From the 2016 CDR data, seven submitters reported eight records of processing CCl₄ as a reactant with each record reporting fewer than 10 sites that process CCl₄ as a reactant. However, five of the eight CDR records are also reported manufacture locations of CCl₄. EPA assesses these five records among the manufacturing section (Section 2.1.2.2). EPA assesses the remaining three reports from CDR in this section. Upon review of 2017 TRI, EPA found eight sites reported using CCl₄ as a reactant ([U.S. EPA, 2017c](#)), and five of these sites are reported manufacturers of CCl₄ in CDR. This falls within the range reported for number of sites from the 2016 CDR. EPA assessed three of the listed TRI submissions that use CCl₄ as a reactant. Between CDR and TRI, EPA assessed a range of six to thirty sites.

EPA determined the number of workers using the related SOC codes from BLS analysis that are associated with the primary NAICS codes listed in TRI. Two of the three submissions in TRI identified the primary NAICS code to be 325199, All Other Basic Organic Chemical Manufacturing, while one was listed as 325120, Industrial Gas Manufacturing ([U.S. EPA, 2017c](#)). For NAICS code 325199, there are an average of 39 workers and 18 ONUs per site, or a total of 57 potentially exposed workers and ONUs. For NAICS code 325120, there are an average of 14 workers and 7 ONUs per site, or a total of 21 potentially exposed workers and ONUs ([U.S. BLS, 2016](#)). Similarly, two of the three submissions in CDR identified the primary NAICS code to be 325199 and one was listed as 325120 ([U.S. EPA, 2016b](#)).

To determine the high-end total number of workers and ONUs, EPA/OPPT used the high-end of ranges reported in the three 2016 CDR reports ([U.S. EPA, 2016b](#)). For the other three TRI submissions, EPA/OPPT used the average worker and ONUs estimates from the BLS analysis based on their NAICS codes ([U.S. BLS, 2016](#)). The CDR data does not differentiate between workers and ONUs; therefore, EPA/OPPT assumed the ratio of workers to ONUs would be similar as determined by NAICS code in the BLS data ([U.S. BLS, 2016](#); [U.S. Census Bureau, 2015](#)). When 325199, approximately 68% of the exposed personnel are workers and 32% are ONUs. When 325120, approximately 67% of the exposed personnel are workers and 33% are ONUs. This resulted in an estimated 3,400 workers and 1,600 ONUs (see Table 2-6).

To determine the low-end total number of workers and ONUs, EPA used the low-end of ranges reported for number of sites in the three CDR reports. Then, EPA assessed using the corresponding number of workers from BLS analysis that are associated with the primary NAICS codes for those entries. ([U.S. BLS, 2016](#); [U.S. EPA, 2016b](#)). For the remaining three TRI sites, EPA used the average worker and ONUs estimates from the BLS analysis and TRI reported NAICS codes ([U.S. EPA, 2017c](#); [U.S. BLS, 2016](#)). This resulted in an estimated 170 workers and 80 ONUs (see Table 2-6).

Table 2-6. Estimated Number of Workers Potentially Exposed to Carbon Tetrachloride During Processing as a Reactant

Number of Sites	Exposed Workers per Site	Exposed Occupational Non-Users per Site	Total Exposed Workers	Total Exposed Occupational Non-Users	Total Exposed
High-End					
9 ^a	340	160	3,059	1,441	4,500
2 ^b	39	18	77	36	114
9 ^c	17	8	153	72	225
9 ^d	7	3	61	29	90
1 ^c	14	7	14	7	20
<i>Total Exposed Workers and ONUs</i>			3,400 ^e	1,600 ^e	4,900 ^e
Low-End					
1 ^a	68	32	68	32	100
2 ^b	39	18	77	36	114
1 ^c	7	3	7	3	10
1 ^d	1	0	1	0	1
1 ^c	14	7	14	7	21
<i>Total Exposed Workers and ONUs</i>			170 ^e	80 ^e	250 ^e

^a Number of workers and occupational non-users per site estimated by taking the either 100 (low-end, per 2016 CDR) or 500 (high-end, per 2016 CDR) and multiplying by 68% and 32% for workers and ONUs, respectively. Values are rounded to the nearest integer.

^b For the sites using values from the BLS analysis, the total number of workers and occupational non-users are calculated using the number of workers and occupational non-users per site estimated from BLS and multiplying by the number of sites. The number of workers and occupational non-users per site presented in the table round the values estimated from the BLS analysis to the nearest integer.

^c Number of workers and occupational non-users per site estimated by taking the either 10 (low-end, per 2016 CDR) or 25 (high-end, per 2016 CDR) and multiplying by 68% and 32% for workers and ONUs, respectively. Values are rounded to the nearest integer.

^d Number of workers and occupational non-users per site estimated by taking the either 1 (low-end, per 2016 CDR) or 10 (high-end, per 2016 CDR) and multiplying by 68% and 32% for workers and ONUs, respectively. Values are rounded to the nearest integer.

^e Totals may not add properly due to rounding to two significant figures.

2.3.2.3 Occupational Exposure Assessment Methodology

2.3.2.3.1 Inhalation Exposure Assessment Results Using Monitoring Data

Table 2-7 summarizes full-shift TWA sample data obtained from a NIOSH Health Hazard Evaluation (HHE) report ([Gilles and Lybarger, 1978](#)) and a journal article ([Ghittori et al., 1994](#)), provided by EPA's Science Advisory Committee on Chemicals (SACC). The data from the NIOSH HHE were collected from Allied Chemical in 1978 for full-shift exposures to CCl₄ ([Gilles and Lybarger, 1978](#)). During operation, there were two to three operators present each shift, 10 to 14 employees were involved in

packaging operations, four employees were engaged in tank farm operations, and there were six to eight individuals in the laboratory who collected and analyzed samples (Gilles and Lybarger, 1978). In Ghittori et al. (1994), personal breathing samples were collected from 55 workers at two facilities using CCl₄ as an intermediate. The study does not present individual data points and associated sample durations but explains that the personal-breathing-zone air sampling took place over four hours for a “half work shift” (Ghittori et al., 1994).

Table 2-7. Summary of Inhalation Exposure Monitoring Data for Use as a Reactant for Carbon Tetrachloride

Study or Company	Full-shift TWA (mg/m ³)	Number of Full-shift Samples	Sample Duration
Allied Chemical (Gilles and Lybarger, 1978)	Max: 6.92 Min: 3.15 Mean: Not provided	Not provided	Not provided
(Ghittori et al., 1994)	Max: 29.8 Min: 1.1 AM: 11.4 ± 7.5 GM: 8.9 ± 2.2	55	4 hrs

AM = Arithmetic Mean; GM = Geometric Mean; ND = Non-detected

2.3.2.3.2 Inhalation Exposure Assessment Results Using Surrogate Data

EPA expects the exposure sources, exposure routes, and exposure levels when using CCl₄ as a reactant to be similar to those when manufacturing CCl₄. See Section 2.1.2.3 for the details of the assessment of worker exposure from chemical manufacturing activities.

The surrogate data provided by HSIA estimates a central tendency exposure of 0.76 mg/m³ 8-hr TWA and a high-end exposure of 4.0 mg/m³ 8-hr TWA. The Ghittori et al. (1994), study included limited data, so the central tendency exposure could be estimated by the arithmetic mean of 11.4 mg/m³ 8-hr TWA and the high-end exposure estimated by the maximum exposure data of 29.8 mg/m³ 8-hr TWA. The high-end surrogate data exposure levels are less than the maximum value in the identified monitoring data from Allied Chemical. Both the NIOSH and Ghittori studies provided limited information on the process, specific worker activities, and any engineering controls used at the sites when analyzing the monitoring data for use of CCl₄ as a reactant. Therefore, the differences in results from these data as compared to the HSIA is unclear.

Table 2-8. Summary of Surrogate Data Results for Processing as a Reactant

Exposure Calculation	Number of Samples	Central Tendency (mg/m ³)	High-End (mg/m ³)	Confidence Rating of Associated Air Concentration Data
8-hr TWA Results				
Full-Shift TWA	113	0.76	4.0	Medium
Acute Concentration (AC)		0.76	4.0	

Exposure Calculation	Number of Samples	Central Tendency (mg/m ³)	High-End (mg/m ³)	Confidence Rating of Associated Air Concentration Data
Average Daily Concentration (ADC)		0.76	4.0	
Lifetime Average Daily Concentration (LADC)		0.07	0.47	
12-hr TWA Results				
Full-Shift TWA	243	0.50	4.8	Medium
AC		0.50	4.8	
ADC		0.50	4.8	
LADC		0.069	0.83	

Equations and parameters for calculation of the ADC, and LADC are described in Appendix B.

Table 2-3 summarizes 8-hr and 12-hr TWA samples for ONU inhalation exposure monitoring data obtained from data submitted by the HSIA via public comment for two companies ([HSIA, 2019](#)).

Table 2-9. Summary of Surrogate ONU Inhalation Exposure Monitoring Data for Processing as a Reactant

Exposure Calculation	Number of Samples	Central Tendency (mg/m ³)	High-End (mg/m ³)	Confidence Rating of Associated Air Concentration Data
8-hr TWA Results				
Full-Shift TWA	14	0.50	1.0	Medium
AC		0.50	1.0	
ADC		0.50	1.0	
LADC		0.046	0.12	
12-hr TWA Results				
Full-Shift TWA	3	0.66	1.3	Medium
AC		0.66	1.3	
ADC		0.66	1.3	
LADC		0.060	0.15	

Equations and parameters for calculation of the ADC, and LADC are described in Appendix B.

2.4 Incorporation into Formulation, Mixture, or Reaction Product

After manufacture, CCl₄ may be supplied directly to end-users, or may be incorporated into various products and formulations at varying concentrations for further distribution. Incorporation into a formulation, mixture, or reaction product refers to the process of mixing or blending several raw materials to obtain a single product or preparation. There are current regulatory actions that prohibit the direct use of CCl₄ as reactant or additive in the formulation of commercially available products for industrial/commercial/consumer uses (including aerosol and non-aerosol adhesives/sealants, paints/coatings, and cleaning/degreasing solvent products), besides as a laboratory chemical. The use of CCl₄ (and mixtures containing it) in household products has also been banned by the CPSC since 1970, with the exception of “unavoidable manufacturing residues of carbon tetrachloride in other chemicals that under reasonably foreseen conditions of use do not result in an atmospheric concentration of carbon tetrachloride greater than 10 parts per million.” (16 CFR 1500.17(a)(2)). Based on the current regulations and the information provided by industry, EPA has determined that these conditions of use do not warrant evaluation.

The categories and subcategories originally listed in the problem formulation document for incorporation into formulation are expected to be either the use of carbon tetrachloride as a reactant to manufacturing a chlorinated compound that is subsequently formulated into a product or as a processing aid/agent used to aid in the manufacture of formulated products (agricultural chemicals, petrochemicals-derived products, and any other basic organic and inorganic chemical manufacturing). The former case is evaluated in the reactant section and the latter in the processing aid section. In both cases, carbon tetrachloride is not meant to make it into the final product (although may be present as impurities as mentioned above).

2.5 Specialty Uses – Aerospace Industry

EPA has conducted public outreach and literature searches to collect and review information about CCl₄ conditions of use. As a result of that analysis, EPA has determined uses of CCl₄ that were previously thought to be a condition of use are actually no longer used in current practices. Consequently, EPA will not consider or evaluate these activities and conditions of use or associated exposures in the risk evaluation for CCl₄. Specialty uses of CCl₄, specifically adhesives and cleaning operations, were identified in the aerospace industry by the Aerospace Industries Association (AIA) ([Riegler, 2017](#)). However, upon reaching out to AIA for specific use details, AIA replied with the following statement:

“After additional investigation, usage identified by AIA companies were based upon products that have been discontinued. There appear to be products that contain trace amounts of carbon tetrachloride (<1%) that might be a reaction by-product, contaminant or imperfect distillation of perchloroethylene. Therefore, carbon tetrachloride is no longer an AIA concern.” ([Aerospace Industries Association \(AIA\), 2019](#))

Based on all present information, EPA will not evaluate the use of CCl₄ in cleaning operations (vapor degreasing, etc.) or use as an adhesive in the risk evaluation as there are no data supporting its use or its presence as an intended component of product formulations used in the aerospace industry. Additionally, there are current regulatory actions (MP and Title VI of the CAA) that prohibit the direct use of CCl₄ in the formulation of commercially available products for industrial, commercial, and consumer uses (including aerosol and non-aerosol adhesives/sealants, paints/coatings, and cleaning/degreasing solvent products), except as a laboratory chemical (Section 2.2.2.1 of the *Problem*

2.6 Specialty Uses - Department of Defense Data

EPA reached out to the Department of Defense (DOD) for monitoring data for the first 10 chemical substances that are the subject of the Agency’s initial chemical risk evaluations. The DoD provided monitoring data from its Defense Occupational and Environmental Health Readiness System – Industrial Hygiene (DOEHRS-IH), which collects occupational and environmental health risk data from each service branch. The DOD provided inhalation monitoring data for three branches of the military: the Army, Air Force, and Navy (DOEHRS-IH, 2018). These data are not distinguished among the three branches.

The following subsections provide an overview of the DOD data. EPA only used the OBOD, or open burning and open detonation, clean-up data in this assessment as these were the only data EPA could use to assess 8-hr TWA exposures. The sampling results for the remaining six processes were measured over a period less than 50 percent of the duration of the process (or an 8-hr shift if the process duration was not specified). Since only a fraction of the process time (or an 8-hr shift) was sampled for these remaining processes, EPA could not use them to estimate 8-hr TWA exposure.

2.6.1 Data Overview

The data provided by DOD includes 105 data points for carbon tetrachloride from samples taken during seven processes:

1. OBOD Clean-Up
2. Detonation Chamber
3. Mobile Detonation Test Facility
4. Plastics/Modeling (Thermoforming)
5. Solvent Extraction of Explosive Samples
6. Glue Sound Dampening Material to Torpedo Body
7. Spray Painting – High Volume, Low Pressure (HVLP) Spray Gun

The provided personal breathing zone samples for all of the DOD activities are summarized in Table 2-10. All sample results are indicated as less than a value, which is considered to be the limit of detection (LOD). The DOD data stated that all workers monitored worked an 8-hr shift. For some processes, the DOD data do not provide the process duration.

Table 2-10. DOD Inhalation Monitoring Results

Process	Worker Activity Description	Worker Activity Frequency	Process Duration (min)	Min. Sample Result (mg/m ³)	Max. Sample Result (mg/m ³)	Number of Samples	Sample Duration (min)	Sample Date
OBOD Clean-Up	Cleaning and sampling residual metal and ash	2-3 Times per Week	1-2 hours	< 1.26 ¹	< 1.26	3	140	Jan. 27, 2015
Detonation Chamber	Destruction of munition and storage of resulting liquid waste	Special Occasions	>10 hours	< 2.9	< 30	95	14-140	2011

Mobile Detonation Test Facility	Destruction of munition and storage of resulting liquid waste	Special Occasions	>10 hours	< 3.8	< 17	3	24-116	June 15, 2011
Plastics/Modeling (Thermoforming)	None provided	2-3 Times per Month	-	< 31.46	-	1	104	Dec. 4, 2015
Solvent Extraction of Explosive Samples	Sampling of energetics with solvent	Weekly	6-8 hours	< 5.52	-	1	60	Sept. 22, 1993
Glue Sound Dampening Material to Torpedo Body	None provided	Special Occasions	-	< 0.217	-	1	221	June 22, 2011
Spray Painting – High Volume, Low Pressure (HVLP) Spray Gun	None provided	Weekly	-	< 3.2	-	1	0 ²	June 5, 2016

¹ All three samples provided were listed as < 0.2 ppm (1.26 mg/m³).

² This was the exact information provided and no explanation was given for this value.

2.6.2 OBOD Clean-Up Process Description

During the OBOD clean-up process, employees clean up residual metal and ash. Small metal pieces and ash are drummed and stored. Once drum(s) are full, personnel perform sampling to determine disposal requirements. Larger pieces of metal can be sold for recycling once deemed inert. Clean-up is performed in steel toe boots, coveralls, and respiratory protection (powered air-purifying respirator [PAPR] with tight-fitting facepiece and organic vapor and HEPA cartridge). A self-contained breathing apparatus (SCBA) is available for emergencies and as needed for clean-up ([DOEHRS-IH, 2018](#)).

2.6.3 Exposure Assessment

As the exposure values are reported to be below the LOD, EPA referenced EPA's *Guidelines for Statistical Analysis of Occupational Exposure Data* (1994) to estimate the exposure value as $\frac{LOD}{\sqrt{2}}$ if the geometric standard deviation of the data is less than 3.0 and $\frac{LOD}{2}$ if the geometric standard deviation is 3.0 or greater ([U.S. EPA, 1994a](#)). However, the given DOD data reports all three samples for the OBOD clean-up as below the LOD. Since these values are unknown a geometric standard deviation cannot be calculated. Therefore, EPA assessed the exposure as a range from 0 to 1.26 mg/m³ using the midpoint (0.68 mg/m³) to calculate the central tendency 8-hr TWA and the maximum value (1.26 mg/m³) to calculate the high end 8-hr TWA. Additionally, the DOD data indicates that OBOD clean-up has a duration of one to two hours. The sampling duration of the January 27, 2015 monitoring was 140 minutes (approximately 2.3 hours). Therefore, EPA expects this monitoring event to have sampled workers during the entirety of the process and the sample results are representative of worker exposures over the course of the process. EPA also considered exposure from the OBOD clean-up process as the only source of exposure for these workers, and the workers' exposures are zero for the remainder of an 8-hr shift. Therefore, EPA averaged the 140-minute midpoint and maximum sample results over eight hours to calculate the 8-hr TWA exposure.

DOD reported the process frequency for the OBOD cleaning as every 2-3 weeks. EPA incorporated this data and adjusted the exposure frequency to reflect the limited work exposure time when calculating the

central tendency and high-end ADC and LADC. The central tendency ADC and LADC are calculated using the midpoint of the process frequency range, 2.5 weeks (125 days/year), and the high-end ADC and LADC are calculated using maximum of the process frequency range, 3 weeks (150 days/year). Results are presented in Table 2-11.

Table 2-11. Summary of Worker Inhalation Exposure Monitoring Data for Specialty Use of Carbon Tetrachloride

Exposure Calculation ⁶	Number of Samples	Central Tendency (mg/m ³)	High-End (mg/m ³)	Confidence Rating of Associated Air Concentration Data
8-hr TWA Results for OBOD Clean-Up				
Full-Shift TWA	3	0.18	0.37	High
AC		0.18	0.37	
ADC		0.092	0.22	
LADC		0.0083	0.026	

2.7 Reactive Ion Etching

2.7.1 Process Description

Reactive ion etching (RIE) is a microfabrication technique used in miniature electronic component manufacture. Ion bombardment and a reactive gas, such as CCl₄, are used to selectively etch wafers ([U.S. EPA, 2017b](#)).

Typically, a clean environment is essential for manufacturing the miniature electronic components (primarily semiconductors) that require RIE. Flaws in the wafer surface or contamination of the materials used can result in “opens” or “shorts” in the transistor circuits, causing them to be unusable. Therefore, current semiconductor fabrication facilities (i.e., ‘fabs’) are built to Class-1 cleanroom specifications, which means there is no more than one particle larger than 0.5-micron in one cubic foot of air. In addition, cleaning operations precede and follow most of the manufacturing process steps. Wet processing, during which wafers are repeatedly immersed in or sprayed with solutions, is commonly used to minimize the risk of contamination. In addition, many processes operate within a positive pressure environment ([OECD, 2010](#)).

2.7.2 Exposure Assessment

EPA estimates that worker exposures to CCl₄ during RIE are negligible. Due to the performance requirements of products typically produced via RIE, CCl₄ is expected to be applied in small amounts in a highly controlled work area, thus eliminating or significantly reducing the potential for exposures. EPA anticipates that CCl₄ is used in RIE applications in limited quantities and among limited facilities. This is consistent with assumptions for similar industry processes provided in the *ESD on Chemical Vapor Deposition in the Semiconductor Industry* and *ESD on Photoresist Use in Semiconductor Manufacturing* ([OECD, 2015, 2010](#)).

⁶ Equations and parameters for calculation of the ADC and LADC are described in Appendix B.

2.7.2.1 Worker Activities

Specific worker activities for RIE were not identified, but EPA utilized the worker activities listed in the *ESD on Photoresist Use in Semiconductor Manufacturing* because worker activities will be similar for RIE as they are for using photoresists. According to the *ESD on Photoresist Use in Semiconductor Manufacturing*, there are two main worker activity groups at a facility that utilizes RIE that include: equipment operators and equipment maintenance/waste management technicians. Equipment operators' main role is to change-out the liquid etching containers containing CCl₄. Equipment maintenance/waste management technicians clean empty containers, clean/maintain equipment, and change-out the excess solvent collection containers ([OECD, 2010](#)).

When workers must enter the cleanroom environment to perform their duties, the worker is required to wear full-body coveralls (i.e., "space suits"), respirators, face shields, and gloves. Additionally, wafers are often manipulated robotically within the closed system, or transferred within "micro" enclosures between process steps to limit worker exposure. However, some sites have separate work areas outside the wafer processing area (e.g., "chemical kitchens") in which the photoresist and other chemical containers and supply lines are connected. If workers handle the photoresist bottles and other chemical containers in a separate area, such as the chemical kitchen, they will likely be wearing solvent-resistant gloves, aprons, goggles, and respirators with organic vapor cartridges to minimize exposure ([OECD, 2010](#)).

2.7.2.2 Number of Potentially Exposed Workers

Based on information in the *ESD on Photoresist Use in Semiconductor Manufacturing*, EPA/OPPT identified the NAICS code 334413, Semiconductor and Related Device Manufacturing, as the NAICS code expected to include sites using CCl₄ as a RIE ([OECD, 2010](#)). EPA estimated the number of workers and ONUs for this NAICS code using Bureau of Labor Statistics' OES data (BLS Data) and the U.S. Census' SUSB (SUSB Data). The method for estimating number of workers from the Bureau of Labor Statistics' OES data and U.S. Census' SUSB data is detailed in Appendix A. This analysis resulted in an average of 50 workers and 45 ONU per site ([U.S. BLS, 2016](#); [U.S. Census Bureau, 2015](#)). EPA does not have data to estimate the number of sites using CCl₄ as a RIE; therefore, only the per site data are presented (see Table 2-12).

Table 2-12. Estimated Number of Workers Potentially Exposed to Carbon Tetrachloride During Use as a RIE

Exposed Workers per Site	Exposed Occupational Non-Users per Site	Total Exposed Per Site
50	45	95

2.8 Industrial Processing Agent/Aid

This section includes the assessment of the use of CCl₄ as a processing agent/aid for petrochemicals-derived products manufacturing, agricultural products manufacturing, and metal recovery. EPA determined these industrial uses are subject to the use of CCl₄ as a process agent listed in the MP side agreement, Decision X/14: Process Agents.

2.8.1 Process Description

According to the TRI *Reporting Forms and Instructions (RFI) Guidance Document*, a processing aid is a “chemical that is added to a reaction mixture to aid in the manufacture or synthesis of another chemical substance but is not intended to remain in or become part of the product or product mixture”. Examples of such chemicals include, but are not limited to, process solvents, catalysts, inhibitors, initiators, reaction terminators, and solution buffers” ([U.S. EPA, 2018d](#)). Additionally, processing agents are intended to improve the processing characteristics or the operation of process equipment, but not intended to affect the function of a substance or article created ([U.S. EPA, 2016a](#)).

The domestic and international use of carbon tetrachloride as a process agent is addressed under the MP side agreement, Decision X/14: Process Agents ([UNEP/Ozone Secretariat, 1998](#)). This decision lists a limited number of specific manufacturing uses of carbon tetrachloride as a process agent (non-feedstock use) in which carbon tetrachloride may not be reacted or destroyed in the production process. Approved uses of carbon tetrachloride as a process agent are listed below in Table 2-8.

Table 2-13. List of Uses of Carbon Tetrachloride as Process Agents in MP Side Agreement, Decision X/14: Process Agents

1	Elimination of nitrogen trichloride in the production of chlorine and caustic	10	Manufacture of chlorinated paraffin
2	Recovery of chlorine in tail gas from production of chlorine	11	Production of Organic and Inorganic Chemicals
3	Manufacture of chlorinated rubber	12	Production of tralomethrine (insecticide)
4	Manufacture of endosulphan (insecticide)	13	Bromohexine hydrochloride
5	Manufacture of isobutyl acetophenone (ibuprofen - analgesic)	14	Diclofenac sodium
6	Manufacture of 1-1, Bis (4-chlorophenyl) 2,2,2- trichloroethanol (dicofol insecticide)	15	Cloxacilin
7	Manufacture of chlorosulphonated polyolefin (CSM)	16	Phenyl glycine
8	Manufacture of poly-phenylene-terephthal-amide	17	Isosorbid mononitrate
9	Manufacture of styrene butadiene rubber	18	Omeprazol

EPA has identified uses of carbon tetrachloride as a process agent in the manufacturing of petrochemical-derived products, agricultural products, inorganic compounds (i.e., chlorine), and chlorinated compounds that are used in the formulation of solvents for cleaning and degreasing, adhesive and sealants, paints and coatings and asphalt ([U.S. EPA, 2017b](#)). Therefore, EPA expects carbon tetrachloride is only present in the listed products as an impurity rather than serving a specific function.

In 1983, EPA presented a report entitled *Preliminary Study of Sources of Carbon Tetrachloride: Final Report* ([U.S. EPA, 1983](#)). In this report, carbon tetrachloride was used as a solvent to dissolve solid reactants during the organic and inorganic chemical manufacturing process. An example of using carbon tetrachloride as a process agent in petrochemicals-derived product manufacturing is the manufacture of chlorinated rubber resins. The resulting resins are thermoplastic, odorless, and non-toxic. Carbon tetrachloride is preferred in this process as it is the only solvent not attacked by chlorine ([U.S. EPA, 2017b](#)).

2.8.2 Exposure Assessment

2.8.2.1 Worker Activities

Based on EPA's knowledge of the chemical industry, worker activities at facilities where CCl₄ is used as a processing agent/aid may involve manually adding CCl₄ or connecting/disconnecting transfer lines used to unload containers into storage or reaction vessels, rinsing/cleaning containers and/or process equipment, collecting and analyzing QC samples, manually loading spent CCl₄ processing aid, or connecting/disconnecting transfer lines used to load spent CCl₄ processing aid into containers.

During processing, workers are primarily exposed while connecting and disconnecting hoses and transfer lines to containers and packaging to be unloaded (e.g., railcars, tank trucks, totes, drums, bottles) and intermediate storage vessels (e.g., storage tanks, pressure vessels). Workers near unloading racks and container unloading stations are potentially exposed to fugitive emissions from equipment leaks and displaced vapor as containers are unloaded. These activities are potential sources of worker exposure through dermal contact with liquid and inhalation of vapors.

ONUs include employees that work at the site where CCl₄ is used as a processing agent/aid, but they do not directly handle the chemical and are therefore expected to have lower inhalation exposures and are not expected to have dermal exposures. ONUs for processing agent/aid include supervisors, managers, and tradesmen that may be in the same area as emission sources but do not perform tasks that result in the same level of exposures as workers.

2.8.2.2 Number of Potentially Exposed Workers

EPA estimated the number of workers and ONUs potentially exposed to CCl₄ at processing agent/aid sites using 2016 CDR data (where available), 2017 TRI data (where available), BLS Data and SUSB Data. The method for estimating number of workers from the Bureau of Labor Statistics' OES data and U.S. Census' SUSB data is detailed in Appendix A. These estimates were derived using industry- and occupation-specific employment data from the BLS and U.S. Census.

In the 2016 CDR, one submitter reported the use as a processing agent/aid in the pesticide, fertilizer, and other agricultural chemical manufacturing industry and indicated this use occurs at fewer than 10 sites ([U.S. EPA, 2016b](#)). EPA identified six sites in TRI that reported using CCl₄ as a processing agent/aid ([U.S. EPA, 2017c](#)). However, four of the six TRI reported sites also reported manufacture and/or reactant use of CCl₄. EPA assesses those four sites among the manufacturing and reactant use sections. EPA assesses the remaining two sites from TRI that reported using CCl₄ as a processing agent/aid in this section. This agrees with the number of sites from the 2016 CDR. Between CDR and TRI, EPA assessed a range of three to twelve sites.

EPA/OPPT identified the primary NAICS code for TRI submissions to be 325199, All Other Basic Organic Chemical Manufacturing, and 211112, Natural Gas Liquid Extraction ([U.S. EPA, 2017c](#)). For NAICS code 325199, there are an average of 39 workers and 18 ONUs per site, or a total of 57 potentially exposed workers and ONUs. For NAICS code 211112, there are an average of three workers and six ONUs per site, or a total of nine potentially exposed workers and ONUs. The CDR submission lists NAICS 325320, Pesticide and Other Agricultural Chemical Manufacturing, where there are an average of 25 workers and seven ONUs per site, or a total of 32 potentially exposed workers and ONUs ([U.S. EPA, 2016b](#)).

To determine the high-end total number of workers and ONUs, EPA/OPPT used the high-end of the range reported in the 2016 CDR ([U.S. EPA, 2016b](#)). For the other two sites, EPA/OPPT used the average worker and ONUs estimates from the BLS analysis based on their NAICS codes ([U.S. BLS, 2016](#)). The CDR data does not differentiate between workers and ONUs; therefore, EPA/OPPT assumed the ratio of workers to ONUs would be similar as determined in the BLS data where approximately 77.5% of the exposed personnel are workers and 22.5% are ONUs. This resulted in an estimated 3,900 workers and 1,200 ONUs (see Table 2-14).

To determine the low-end total number of workers and ONUs, EPA/OPPT used the low-end of ranges reported in CDR and the worker-to-ONU ratio from the BLS data ([U.S. BLS, 2016](#); [U.S. Census Bureau, 2015](#)). For the remaining two sites where, EPA/OPPT used the average worker and ONUs estimates from the BLS analysis and TRI reported NAICS codes ([U.S. EPA, 2017c](#); [U.S. BLS, 2016](#)). This resulted in an estimated 120 workers and 47 ONUs potentially exposed at sites using CCl₄ as a processing agent/aid (see Table 2-14).

Table 2-14. Estimated Number of Workers Potentially Exposed to Carbon Tetrachloride During Use as a Processing Agent/Aid

Number of Sites	Exposed Workers per Site	Exposed Occupational Non-Users per Site	Total Exposed Workers	Total Exposed Occupational Non-Users	Total Exposed
High-End					
1 ^a	3	6	3	6	9
1 ^a	39	18	39	18	57
10 ^b	387	113	3,873	1,127	5,000
<i>Total Exposed Workers and ONUs</i>			3,900 ^c	1,200 ^c	5,100 ^c
Low-End					
1 ^a	3	6	3	6	9
1 ^a	39	18	39	18	57
1 ^b	77	23	77	23	100
<i>Total Exposed Workers and ONUs</i>			120 ^c	47 ^c	170 ^c

^a For the sites using values from the BLS analysis, the total number of workers and occupational non-users are calculated using the number of workers and occupational non-users per site estimated from BLS and multiplying by the number of sites. The number of workers and occupational non-users per site presented in the table round the values estimated from the BLS analysis to the nearest integer.

^b Number of workers and occupational non-users per site estimated by taking the either 100 (low-end, per 2016 CDR) or 500 (high-end, per 2016 CDR) and multiplying by 68% and 32% for workers and ONUs, respectively. Values are rounded to the nearest integer.

^c Totals may not add properly due to rounding to two significant figures.

2.8.2.3 Occupational Exposure Assessment Methodology

EPA did not find any exposure data for use of CCl₄ as a processing agent/aid; therefore, exposures from incorporation into formulation activities were assessed with surrogate data from HSIA.

2.8.2.4 Occupational Exposure Results

The exposure sources, routes, and exposure levels are similar to those at an import/repackaging facility. Inhalation exposure assessment for processing CCl₄ as a processing agent/aid is estimated using the surrogate data from HSIA as described in the import/repackaging scenario. See Section 2.2.2.3 for the assessment of worker exposure from chemical unloading activities.

2.9 Additive

2.9.1 Process Description

Additives are chemicals combined with a chemical product to enhance the properties of the product. Additives typically stay mixed within the finished product and remain unreacted.

Use of CCl₄ as an additive typically involves unloading formulation components from transport containers, either directly into the mixing equipment or into an intermediate storage vessel, mixing of components in either a batch or continuous system, QC sampling, and final packaging of the product into containers.

Current known uses of CCl₄ as an additive include both an additive used in plastic components used in the automotive industry ([Holmes, 2017](#)) and a fuel additive ([U.S. EPA, 2017b](#)).

2.9.1 Exposure Assessment

2.9.1.1 Worker Activities

Similar to manufacturing facilities, worker activities use of CCl₄ as an additive may involve manually adding raw materials or connecting/disconnecting transfer lines used to unload containers into storage or reaction vessels, rinsing/cleaning containers and/or process equipment, collecting and analyzing QC samples, and packaging formulated products into containers and tank trucks. The exact activities and associated level of exposure will differ depending on the degree of automation, presence of engineering controls, and use of personal protective equipment (PPE) at each facility.

ONUs include employees that work at the site where CCl₄ is used as an additive, but they do not directly handle the chemical and are therefore expected to have lower inhalation exposures and are not expected to have dermal exposures. ONUs for use of CCl₄ as an additive include supervisors, managers, and tradesmen that may be in the same area as exposure sources but do not perform tasks that result in the same level of exposures as workers.

2.9.1.2 Number of Potentially Exposed Workers

EPA estimated the number of workers and occupational non-users potentially exposed to CCl₄ at processing sites using 2016 CDR data (where available), 2017 TRI data (where available), BLS Data and SUSB Data. The method for estimating number of workers from the Bureau of Labor Statistics' OES data and U.S. Census' SUSB data is detailed in Appendix A. These estimates were derived using industry- and occupation-specific employment data from the BLS and U.S. Census.

Upon review of the 2017 TRI data, EPA found that one site reported the use of CCl₄ as a formulation component ([U.S. EPA, 2017c](#)). EPA determined the number of workers using the related SOC codes from BLS analysis that are associated with the primary NAICS codes listed in TRI ([U.S. BLS, 2016](#)).

The primary NAICS code is 325211, Plastics Material and Resin Manufacturing. For NAICS code 325211, there are an average of 27 workers and 12 ONUs per site, or a total of 39 potentially exposed workers and ONUs (see Table 2-15). This analysis resulted in 27 workers and 12 ONUs potentially exposed at sites incorporating CCl₄ as an additive.

Table 2-15. Estimated Number of Workers Potentially Exposed to Carbon Tetrachloride when used as an Additive

Number of Sites	Exposed Workers per Site	Exposed Occupational Non-Users per Site	Total Exposed Workers	Total Exposed Occupational Non-Users	Total Exposed
1 ^a	27	12	27	12	39
<i>Total Exposed Workers and ONUs</i>			27	12	39

^aFor the sites using values from the BLS analysis, the total number of workers and occupational non-users are calculated using the number of workers and occupational non-users per site estimated from BLS and multiplying by the number of sites. The number of workers and occupational non-users per site presented in the table round the values estimated from the BLS analysis to the nearest integer.

2.9.1.3 Occupational Exposure Assessment Methodology

EPA did not find any exposure data for use of CCl₄ as an additive; therefore, exposures from incorporation into formulation activities were assessed with surrogate data from HSIA.

2.9.1.4 Occupational Exposure Results

EPA assumes the exposure sources, routes, and exposure levels are similar to those at an import/repackaging facility. Inhalation exposure assessment for using CCl₄ as an additive is estimated using the surrogate data from HSIA as described in the import/repackaging scenario. See Section 2.2.2.3 for the assessment of worker exposure from chemical unloading activities.

2.10 Laboratory Chemicals

2.10.1 Process Description

Carbon tetrachloride is used in a variety of laboratory applications, which include, but are not limited to, the following:

- Chemical reagent;
- Extraction solvent and;
- Reference material or solvent in analytical procedures, such as spectroscopic measurements ([U.S. EPA, 2017b](#)).

Specific process descriptions for how CCl₄ is used in each of these applications is not known. In general, CCl₄ is received in small containers and used in small quantities on a lab bench in a fume cupboard or hood. After use, waste CCl₄ is collected and disposed or recycled. Figure 2-2 this general process.

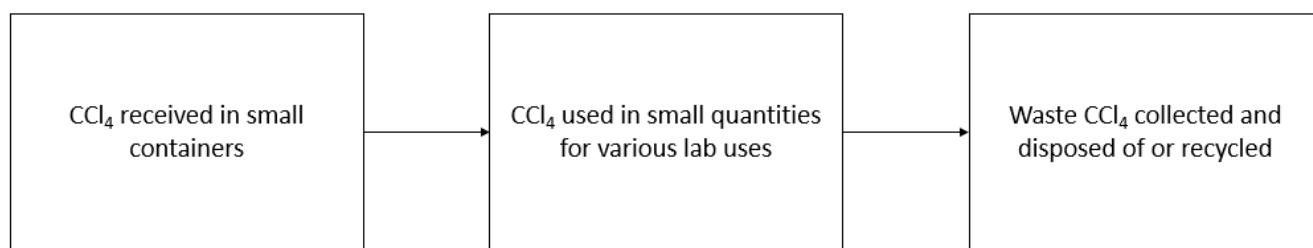

Figure 2-2. General Laboratory Use Process Flow Diagram

2.10.2 Exposure Assessment

EPA does not have data to assess worker exposures to CCl₄ during laboratory use. However, due to the expected safety practices when using chemicals in a laboratory setting, CCl₄ is expected to be applied in small amounts under a fume hood as per good laboratory practice, thus reducing the potential for inhalation exposures.

2.10.2.1 Worker Activities

Specific worker activities for using laboratory uses were not identified, but EPA expects that workers may be potentially exposed to CCl₄ in laboratories during multiple activities, including unloading of CCl₄ from the containers in which they were received, transferring CCl₄ into laboratory equipment (i.e., beakers, flasks, other intermediate storage containers), dissolving substances into CCl₄ or otherwise preparing samples that contain CCl₄, analyzing these samples, and discarding the samples.

ONUs include employees that work at the sites where CCl₄ is used, but they do not directly handle the chemical and are therefore expected to have lower inhalation exposures and are not expected to have dermal exposures. ONUs for this condition of use include supervisors, managers, and other employees that may be in the laboratory but do not perform tasks that result in the same level of exposures as those workers that engage in tasks related to the use of CCl₄.

2.10.2.2 Number of Potentially Exposed Workers

EPA estimated the number of workers and occupational non-users potentially exposed to CCl₄ at laboratories using 2016 CDR data (where available), BLS Data and SUSB Data. The method for estimating number of workers from the Bureau of Labor Statistics' OES data and U.S. Census' SUSB data is detailed in Appendix A. These estimates were derived using industry- and occupation-specific employment data from the BLS and U.S. Census. The 2016 CDR Data reports one industrial use of CCl₄ as a laboratory chemical for fewer than ten sites ([U.S. EPA, 2016b](#)).

EPA identified the NAICS code 541380, Testing Laboratories, as the code expected to include laboratory chemical use of CCl₄. Based on data from the BLS for this NAICS code and related SOC codes, there are an average of one worker and nine ONUs per site, or a total of ten potentially exposed workers and ONUs per site. EPA assessed the number of workers and ONUs based on the data from BLS ([U.S. BLS, 2016](#)).

To determine the high-end total number of workers and ONUs, EPA used the high-end number of sites from CDR (nine sites) and the BLS OES data to estimate number of workers and ONUs per site ([U.S. BLS, 2016](#); [U.S. EPA, 2016b](#)). This resulted in a total of 230 exposed workers and ONUs (see Table 2-16).

To determine the low-end total number of workers and ONUs, EPA used the low-end number of sites from CDR (one site) and the BLS OES data to estimate workers and ONUs per site listed for these industrial use sites ([U.S. BLS, 2016](#); [U.S. EPA, 2016b](#)). This resulted in a total of ten exposed workers and ONUs (see Table 2-16).

Table 2-16. Estimated Number of Workers Potentially Exposed to Carbon Tetrachloride During Use as a Laboratory Chemical

Number of Sites	Exposed Workers per Site	Exposed Occupational Non-Users per Site	Total Exposed Workers	Total Exposed Occupational Non-Users	Total Exposed
High-End					
9 ^a	3	22	23	200 ^b	230 ^b
Low-End					
1 ^a	1	9	1	9	10

^a Number of workers and occupational non-users per site estimated by taking the either 10 (low-end, per 2016 CDR) or 25 (high-end, per 2016 CDR) and multiplying by 10% and 90% for workers and ONUs, respectively. Values are rounded to the nearest integer.

^b Totals are rounded to two significant figures.

2.11 Disposal/Recycling

This scenario is meant to include sites like hazardous waste treatment sites (treatment, storage and disposal facilities, or TSDFs), including incinerators, landfills, other forms of treatment, and solvent or other material reclamation or recycling. These are sites largely covered under RCRA (e.g., RCRA permitted TSDFs) but also includes municipal waste combustors and landfills.

2.11.1 Process Description

Each of the conditions of use of CCl₄ may generate waste streams of the chemical that are collected and transported to third-party sites for disposal, treatment, or recycling. Industrial sites that treat or dispose onsite wastes that they themselves generate are assessed in each condition of use assessment in Sections 1 through 11. Wastes of CCl₄ that are generated during a condition of use and sent to a third-party site for treatment, disposal, or recycling may include the following:

- Wastewater: CCl₄ may be contained in wastewater discharged to POTW or other, non-public treatment works for treatment. Industrial wastewater containing CCl₄ discharged to a POTW may be subject to EPA or authorized National Pollutant Discharge Elimination System (NPDES) state pretreatment programs.
- Solid Wastes: Solid wastes are defined under RCRA as any material that is discarded by being: abandoned; inherently waste-like; a discarded military munition; or recycled in certain ways (certain instances of the generation and legitimate reclamation of secondary materials are exempted as solid wastes under RCRA). Solid wastes may subsequently meet RCRA's definition of hazardous waste by either being listed as a waste at 40 CFR §§ 261.30 to 261.35 or by meeting waste-like characteristics as defined at 40 CFR §§ 261.20 to 261.24. Solid wastes that are hazardous wastes are regulated under the more stringent requirements of Subtitle C of

RCRA, whereas non-hazardous solid wastes are regulated under the less stringent requirements of Subtitle D of RCRA.

- CCl₄ is both a listed and a characteristic hazardous waste. CCl₄ is a non-specific-source listed hazardous waste under waste number F001 (spent halogenated degreasing solvents) (40 CFR § 261.31) and a source-specific listed hazardous waste under waste number K016 (heavy ends or distillation residues from the production of CCl₄, which may contain residual CCl₄) (40 CFR §261.32). Discarded, commercial-grade CCl₄ is a listed hazardous waste under waste number U211 (40 CFR § 261.33).
- CCl₄ is a toxic contaminant under RCRA with waste number D019. A solid waste can be a hazardous waste due to its toxicity characteristic if its extract following the Toxicity Characteristic Leaching Procedure (TCLP) (or the liquid waste itself if it contains less than 0.5% filterable solids) contains at least 0.5 mg/L of CCl₄ (40 CFR § 261.24).
- Wastes Exempted as Solid Wastes under RCRA: Certain conditions of use of CCl₄ may generate wastes of CCl₄ that are exempted as solid wastes under 40 CFR § 261.4(a). For example, the generation and legitimate reclamation of hazardous secondary materials of CCl₄ may be exempt as a solid waste.

2016 TRI data lists off-site transfers of CCl₄ to land disposal, wastewater treatment, incineration, and recycling facilities ([U.S. EPA, 2017c](#)). See Figure 2-3 for a general depiction of the waste disposal process.

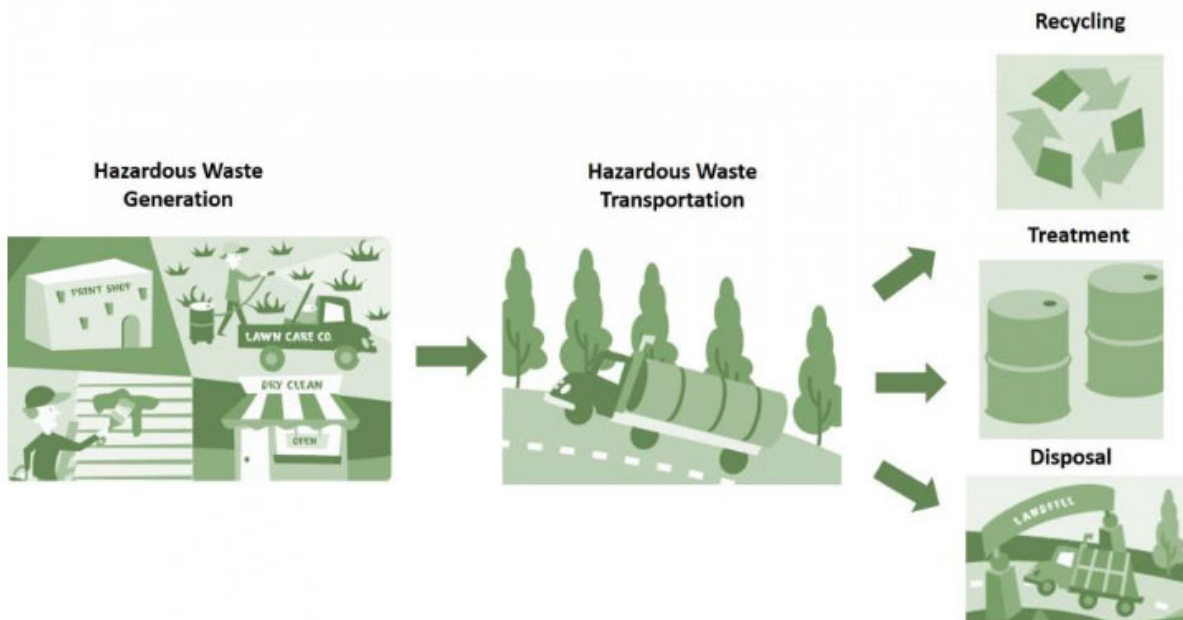

Figure 2-3. Typical Waste Disposal Process

Source: ([U.S. EPA, 2017a](#))

Municipal Waste Incineration

Municipal waste combustors (MWCs) that recover energy are generally located at large facilities

comprising an enclosed tipping floor and a deep waste storage pit. Typical large MWCs may range in capacity from 250 to over 1,000 tons per day. At facilities of this scale, waste materials are not generally handled directly by workers. Trucks may dump the waste directly into the pit, or waste may be tipped to the floor and later pushed into the pit by a worker operating a front-end loader. A large grapple from an overhead crane is used to grab waste from the pit and drop it into a hopper, where hydraulic rams feed the material continuously into the combustion unit at a controlled rate. The crane operator also uses the grapple to mix the waste within the pit, in order to provide a fuel consistent in composition and heating value, and to pick out hazardous or problematic waste.

Facilities burning refuse-derived fuel (RDF) conduct on-site sorting, shredding, and inspection of the waste prior to incineration to recover recyclables and remove hazardous waste or other unwanted materials. Sorting is usually an automated process that uses mechanical separation methods, such as trommel screens, disk screens, and magnetic separators. Once processed, the waste material may be transferred to a storage pit, or it may be conveyed directly to the hopper for combustion.

Tipping floor operations may generate dust. Air from the enclosed tipping floor, however, is continuously drawn into the combustion unit via one or more forced air fans to serve as the primary combustion air and minimize odors. Dust and lint present in the air is typically captured in filters or other cleaning devices in order to prevent the clogging of steam coils, which are used to heat the combustion air and help dry higher-moisture inputs ([Kitto, 1992](#)).

Hazardous Waste Incineration

Commercial scale hazardous waste incinerators are generally two-chamber units, a rotary kiln followed by an afterburner, that accept both solid and liquid waste. Liquid wastes are pumped through pipes and are fed to the unit through nozzles that atomize the liquid for optimal combustion. Solids may be fed to the kiln as loose solids gravity fed to a hopper, or in drums or containers using a conveyor ([ETC, 2018](#); [Heritage, 2018](#)).

Incoming hazardous waste is usually received by truck or rail, and an inspection is required for all waste received. Receiving areas for liquid waste generally consist of a docking area, pumphouse, and some kind of storage facilities. For solids, conveyor devices are typically used to transport incoming waste ([ETC, 2018](#); [Heritage, 2018](#)).

Smaller scale units that burn municipal solid waste or hazardous waste (such as infectious and hazardous waste incinerators at hospitals) may require more direct handling of the materials by facility personnel. Units that are batch-loaded require the waste to be placed on the grate prior to operation and may involve manually dumping waste from a container or shoveling waste from a container onto the grate.

In incineration, complete combustion is necessary to prevent phosgene formation and acid scrubbers must be used to remove any haloacids produced ([ATSDR, 2005](#)).

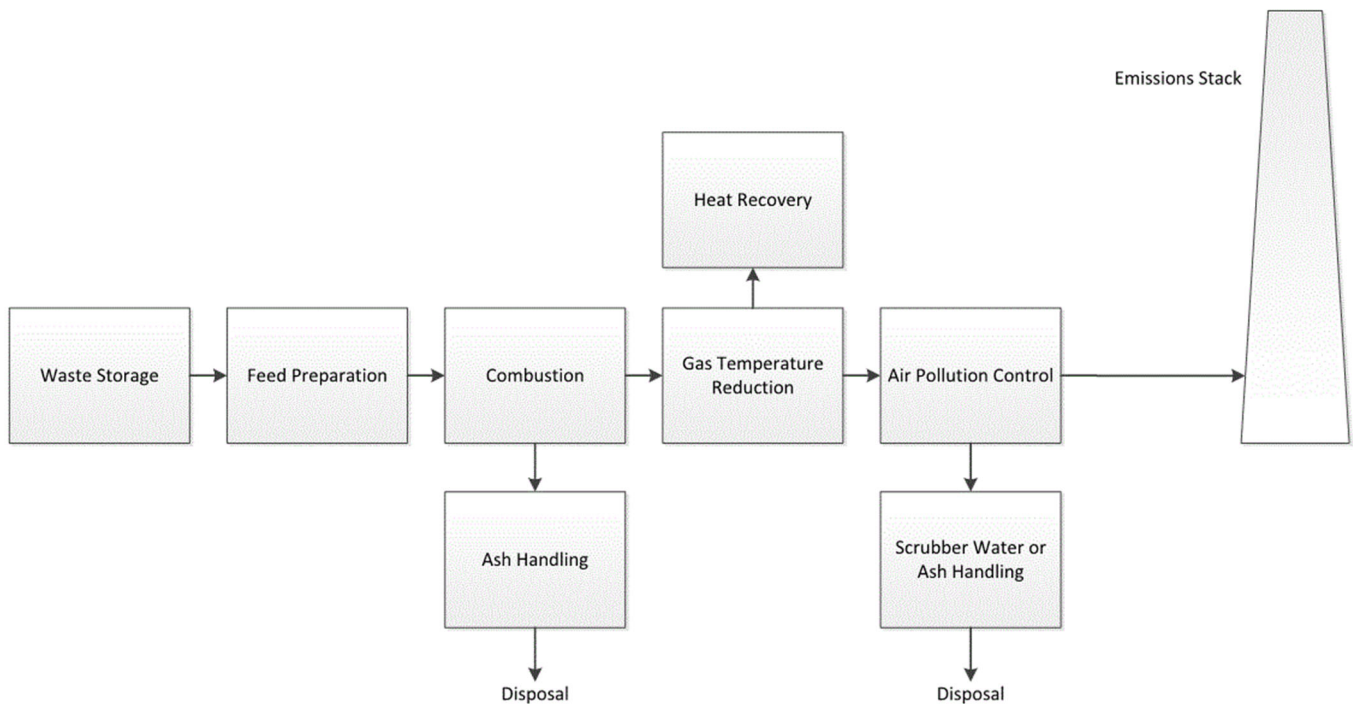

Figure 2-4. Typical Industrial Incineration Process

Municipal Waste Landfill

Municipal solid waste landfills are discrete areas of land or excavated sites that receive household wastes and other types of non-hazardous wastes (e.g. industrial and commercial solid wastes). Standards and requirements for municipal waste landfills include location restrictions, composite liner requirements, leachate collection and removal system, operating practices, groundwater monitoring requirements, closure-and post-closure care requirements, corrective action provisions, and financial assurance. Non-hazardous solid wastes are regulated under RCRA Subtitle D, but states may impose more stringent requirements.

Municipal solid wastes may be first unloaded at waste transfer stations for temporary storage, prior to being transported to the landfill or other treatment or disposal facilities.

Hazardous Waste Landfill

Hazardous waste landfills are excavated or engineered sites specifically designed for the final disposal of non-liquid hazardous wastes. Design standards for these landfills require double liner, double leachate collection and removal systems, leak detection system, run on, runoff and wind dispersal controls, and construction quality assurance program (U.S. EPA, 2018b). There are also requirements for closure and post-closure, such as the addition of a final cover over the landfill and continued monitoring and maintenance. These standards and requirements prevent potential contamination of groundwater and nearby surface water resources. Hazardous waste landfills are regulated under Part 264/265, Subpart N.

CCl₄ is listed as a hazardous waste under RCRA and federal regulations prevent land disposal of various chlorinated solvents that may contain CCl₄ (ATSDR, 2005). CCl₄ may be disposed of by absorption in

vermiculite, dry sand, earth, or other similar material and then buried in a secured sanitary landfill or incinerated ([ATSDR, 2005](#)).

Solvent Recovery

Waste solvents are generated when it becomes contaminated with suspended and dissolved solids, organics, water, or other substances. Waste solvents can be restored to a condition that permits reuse via solvent reclamation/recycling. The recovery process involves an initial vapor recovery (e.g., condensation, adsorption and absorption) or mechanical separation (e.g., decanting, filtering, draining, setline and centrifuging) step followed by distillation, purification and final packaging. Worker activities are expected to be unloading of waste solvents and loading of reclaimed solvents. Figure 2-5 illustrates a typical solvent recovery process flow diagram ([U.S. EPA, 1980](#)).

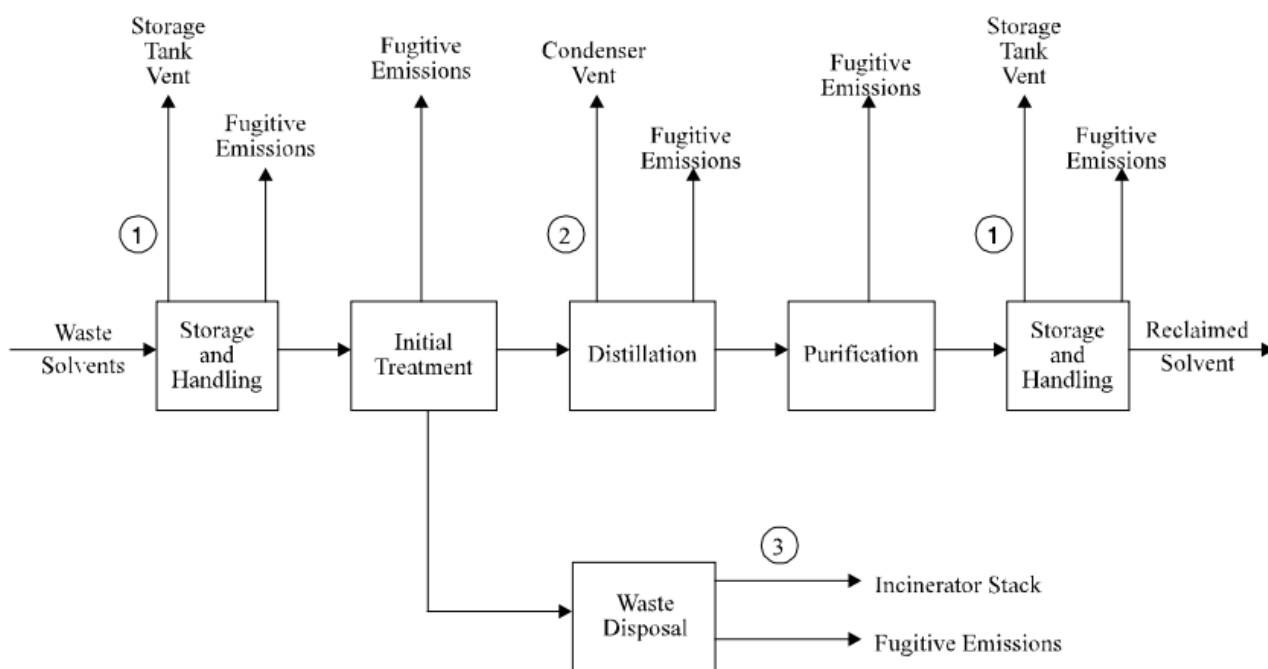

Figure 2-5. General Process Flow Diagram for Solvent Recovery Processes

Source: ([U.S. EPA, 1980](#))

2.11.2 Exposure Assessment

The following sections detail EPA's occupational exposure assessment for waste handling of CCl₄.

2.11.2.1 Worker Activities

At waste disposal sites, workers are potentially exposed via dermal contact with waste containing CCl₄ or via inhalation of CCl₄ vapor. Depending on the concentration of CCl₄ in the waste stream, the route and level of exposure may be similar to that associated with container unloading activities.

Municipal Waste Incineration

At municipal waste incineration facilities, there may be one or more technicians present on the tipping floor to oversee operations, direct trucks, inspect incoming waste, or perform other tasks as warranted by

individual facility practices. These workers may wear protective gear such as gloves, safety glasses, or dust masks. Specific worker protocols are largely up to individual companies, although state or local regulations may require certain worker safety standards be met. Federal operator training requirements pertain more to the operation of the regulated combustion unit rather than operator health and safety.

Workers are potentially exposed via inhalation to vapors while working on the tipping floor. Potentially-exposed workers include workers stationed on the tipping floor, including front-end loader and crane operators, as well as truck drivers. The potential for dermal exposures is minimized by the use of trucks and cranes to handle the wastes.

Hazardous Waste Incineration

More information is needed to determine the potential for worker exposures during hazardous waste incineration and any requirements for personal protective equipment. There is likely a greater potential for worker exposures for smaller scale incinerators that involve more direct handling of the wastes.

Municipal and Hazardous Waste Landfill

At landfills, typical worker activities may include operating refuse vehicles to weigh and unload the waste materials, operating bulldozers to spread and compact wastes, and monitoring, inspecting, and surveying the landfill site ([CalRecycle, 2018](#)). The potential for direct worker handling of the wastes is unknown.

2.11.2.2 Number of Potentially Exposed Workers

EPA estimated the number of workers and occupational non-users potentially exposed to CCl₄ at waste handling sites using 2016 CDR data (where available), 2017 TRI data (where available), BLS Data and SUSB Data. The method for estimating number of workers from the Bureau of Labor Statistics' OES data and U.S. Census' SUSB data is detailed in Appendix A. These estimates were derived using industry- and occupation-specific employment data from the BLS and U.S. Census.

The 2016 CDR uses did not show any submissions for waste handling, so EPA reviewed the 2017 TRI data and found twelve sites reported using CCl₄ during waste handling ([U.S. EPA, 2017c](#)).

EPA determined the number of workers using the related SOC codes from BLS analysis that are associated with the primary NAICS codes listed in TRI ([U.S. BLS, 2016](#)). Ten submissions in TRI identified the primary NAICS code to be 562211, Hazardous Waste Treatment and Disposal, while one was listed as 327310, Cement manufacturing, and the last one was listed as 562213, Solid Waste Combustors and Incinerators. For NAICS code 562211, there are an average of nine workers and five ONUs per site, or a total of 14 potentially exposed workers and ONUs. For NAICS code 327310, there are an average of 22 workers and three ONUs per site, or a total of 25 potentially exposed workers and ONUs. For NAICS code 562213, there are an average of 13 workers and eight ONUs per site, or a total of 21 potentially exposed workers and ONUs ([U.S. BLS, 2016](#); [U.S. Census Bureau, 2015](#)).

This analysis resulted in 130 workers and 63 ONUs potentially exposed at sites using CCl₄ as a processing agent/aid (see Table 2-17).

Table 2-17. Estimated Number of Workers Potentially Exposed to Carbon Tetrachloride During Waste Handling

Number of Sites	Exposed Workers per Site	Exposed Occupational Non-Users per Site	Total Exposed Workers	Total Exposed Occupational Non-Users	Total Exposed
10 ^a	9	5	90	52	142
1 ^a	13	8	13	8	21
1 ^a	22	3	22	3	25
<i>Total Exposed Workers and ONUs</i>			130 ^b	63	190 ^b

^a For the sites using values from the BLS analysis, the total number of workers and occupational non-users are calculated using

the number of workers and occupational non-users per site estimated from BLS and multiplying by the number of sites.

^b Totals may not add properly due to rounding to two significant figures.

2.11.2.3 Occupational Exposure Assessment Methodology

EPA did not find any exposure data for waste handling of CCl₄.; Therefore, exposures from waste handling activities were assessed with surrogate data from HSIA.

2.11.2.4 Occupational Exposure Results

The exposure sources, routes, and exposure levels are similar to those at an import/repackaging facility. Inhalation exposure assessment for the waste handling of CCl₄ is estimated using the surrogate data from HSIA as described in the import/repackaging scenario. See Section 2.2.2.3 for the assessment of worker exposure from chemical unloading activities.

2.12 Dermal Exposure Assessment

Because CCl₄ is a volatile liquid, the dermal absorption of CCl₄ depends on the type and duration of exposure. Where exposure is not occluded, only a fraction of CCl₄ that comes into contact with the skin will be absorbed as the chemical readily evaporates from the skin. However, dermal exposure may be significant in cases of occluded exposure, repeated contacts, or dermal immersion. For example, work activities with a high degree of splash potential may result in CCl₄ liquids trapped inside the gloves, inhibiting the evaporation of CCl₄ and increasing the exposure duration.

To assess exposure, EPA used the *Dermal Exposure to Volatile Liquids* Model (see following equation) to calculate the dermal retained dose for both non-occluded and occluded scenarios. The equation modifies the *EPA/OPPT 2-Hand Dermal Exposure to Liquids Model* by incorporating a “fraction absorbed (*f_{abs}*)” parameter to account for the evaporation of volatile chemicals and a “protection factor (PF)” to account for glove use (U.S. EPA, 2013). Default PF values, which vary depending on the type of glove used and the presence of employee training program, are shown in Table 2-18:

$$D_{exp} = S \times \frac{(Q_u \times f_{abs})}{PF} \times Y_{derm} \times FT \quad \text{Equation 1}$$

Where:

- S is the surface area of contact (cm²)
- Q_u is the quantity remaining on the skin (mg/cm²-event)
- Y_{derm} is the weight fraction of the chemical of interest in the liquid (0 ≤ Y_{derm} ≤ 1)
- FT is the frequency of events (integer number per day)
- f_{abs} is the fraction of applied mass that is absorbed (Default: 0.04 for CCl₄)
- PF is the glove protection factor (Default: see Table 2-18)

The steady state fractional absorption (f_{abs}) for CCl₄ is estimated to be 0.04 based on a theoretical framework provided by Kasting and Miller (2006), meaning approximately four percent of the applied dose is absorbed through the skin following exposure in industrial settings.

Table 2-18. Glove Protection Factors for Different Dermal Protection Strategies

Dermal Protection Characteristics	Setting	Protection Factor, PF
a. No gloves used, or any glove / gauntlet without permeation data and without employee training	Industrial and Commercial Uses	1
b. Gloves with available permeation data indicating that the material of construction offers good protection for the substance		5
c. Chemically resistant gloves (i.e., as b above) with “basic” employee training		10
d. Chemically resistant gloves in combination with specific activity training (e.g., procedure for glove removal and disposal) for tasks where dermal exposure can be expected to occur	Industrial Uses Only	20

Table 2-19 presents the estimated dermal retained dose for *workers* in various exposure scenarios, focusing on what-if scenarios for glove use. The dose estimates assume one exposure event (applied dose) per work day and that approximately four percent of the applied dose is absorbed through the skin during industrial settings. The conditions of use for CCl₄ are industrial uses that generally occur in closed systems where dermal exposure is likely limited to chemical loading/unloading activities (e.g., connecting hoses) and taking quality control samples. Across all types of uses, the maximum possible exposure concentration (Y_{derm}) exists during industrial uses that occur in closed systems. Therefore, all conditions of use for CCl₄ are assessed at the maximum Y_{derm}, or 1.

In addition to the what-if scenarios for glove use, EPA considered the potential for occluded dermal exposures; however, based on the worker activities for the condition of use for CCl₄, EPA determined occluded exposures to be unlikely. Occluded scenarios are generally expected where workers are expected to come into contact with bulk liquid CCl₄ during use in open systems (e.g., during solvent changeout in vapor degreasing and dry cleaning) and not expected in closed systems (e.g., during connection/disconnection of hoses used in loading of bulk containers in manufacturing). For further description of the applicable scenarios including occlusion, see Appendix E. EPA assesses the following what-if glove use scenarios for all conditions of use of CCl₄:

- No gloves used: Operators in these industrial uses, while working around closed-system equipment, may not wear gloves or may wear gloves for abrasion protection or gripping that are not chemical resistant.

- Gloves used with a protection factor of 5, 10, and 20: Operators may wear chemical-resistant gloves when taking quality control samples or when connecting and disconnecting hoses during loading/unloading activities. EPA assumes gloves may offer a range of protection, depending on the type of glove and employee training provided.
- Scenarios not assessed: EPA does not assess occlusion as workers in these industries are not likely to come into contact with bulk liquid CCl₄ that could lead to chemical permeation under the cuff of the glove or excessive liquid contact time leading to chemical permeation through the glove.

As shown in the Table 2-19, the calculated retained dose is low for all non-occluded scenarios as CCl₄ evaporates quickly after exposure. Dermal exposure to liquid is not expected for occupational non-users, as they do not directly handle CCl₄.

Table 2-19. Estimated Dermal Retained Dose (mg/day) for Workers in All Conditions of Use

Condition of Use	Non-Occluded Exposure				Occluded Exposure
	No Gloves (PF = 1)	Protective Gloves (PF = 5)	Protective Gloves (PF = 10)	Protective Gloves (Industrial uses, PF = 20)	
Manufacture	30 (CT) 90 (HE)	6 (CT) 18 (HE)	3 (CT) 9 (HE)	1.5 (CT) 4.5 (HE)	N/A – occlusion not expected
Import and repackaging					
Additive					
Processing as a Reactant					
Processing - Processing Agent/Aid					
Recycling					
Waste disposal					
Laboratory Chemicals					
Specialty Uses - Department of Defense Data					
Reactive Ion Etching					
Incorporation into Formulation	Not assessing due to regulatory actions banning use of carbon tetrachloride in commercially available products and lack of current use of Carbon tetrachloride in aerospace industry				
Specialty Uses - Aerospace					

2.13 Summary of Occupational Exposure Assessment

Table 2-20 presents the occupational exposure assessment summary for the conditions of use described by the previous sections of this report.

Table 2-20. Summary of Occupational Exposure Assessment for Workers

Condition of Use	8-Hour or 12-Hour TWA Exposures		Acute Exposures		Chronic, Non-Cancer Exposures		Chronic, Cancer Exposures		TWA Data Points	Data Type
	C _{CCl4, 8 or 12-hr TWA} (mg/m ³)		ADC _{CCl4} (mg/m ³)		ADC _{CCl4} (mg/m ³)		LADC _{CCl4} (mg/m ³)			
	High-End	Central Tendency	High-End	Central Tendency	High-End	Central Tendency	High-End	Central Tendency		
Manufacturing - 8-hr TWA	4.0	0.76	4.0	0.76	4.0	0.76	0.47	0.069	113	Monitoring Data
Manufacturing - 12-hr TWA	4.8	0.50	4.8	0.50	4.8	0.50	0.83	0.069	243	Monitoring Data
Import/Repackaging	2.9	0.89	2.9	0.89	2.9	0.89	0.34	0.10	15	Surrogate Monitoring Data
Processing as Reactant/Intermediate – 8-hr TWA	4.0	0.76	4.0	0.76	4.0	0.76	0.47	0.069	113	Surrogate Monitoring Data
Processing as Reactant/Intermediate - 12-hr TWA	4.8	0.50	4.8	0.50	4.8	0.50	0.83	0.069	243	Surrogate Monitoring Data
Incorporation into Formulation	Not assessing due to regulatory actions banning use of CCl ₄ in commercially available products									
Specialty Uses - Aerospace	Not assessing due to lack of current use of CCl ₄									
Specialty Uses - Department of Defense Data	0.37	0.18	0.37	0.18	0.22	0.092	0.026	0.0083	3	Monitoring Data
Reactive Ion Etching	Negligible - Highly controlled work areas with small quantities applied									
Industrial Processing Aid	2.9	0.89	2.9	0.89	2.9	0.89	0.34	0.10	15	Surrogate Monitoring Data
Additive	2.9	0.89	2.9	0.89	2.9	0.89	0.34	0.10	15	Surrogate Monitoring Data
Laboratory Chemicals	No data – exposure expected to be low as lab use will likely be in small quantities in a fume hood.									
Waste Handling	2.9	0.89	2.9	0.89	2.9	0.89	0.34	0.10	15	Surrogate Monitoring Data

3 Discussion of Uncertainties and Limitations

3.1 Variability

EPA addressed variability in models by identifying key model parameters to apply a statistical distribution that mathematically defines the parameter's variability. EPA defined statistical distributions for parameters using documented statistical variations where available.

3.2 Uncertainties and Limitations

Uncertainty is “the lack of knowledge about specific variables, parameters, models, or other factors” and can be described qualitatively or quantitatively ([U.S. EPA, 2001](#)). The following sections discuss uncertainties in each of the assessed CCl₄ use scenarios.

3.2.1 Number of Workers

There are a number of uncertainties surrounding the estimated number of workers potentially exposed to CCl₄, as outlined below.

First, BLS' OES employment data for each industry/occupation combination are only available at the 3-, 4-, or 5-digit NAICS level, rather than the full 6-digit NAICS level. This lack of granularity could result in an overestimate of the number of exposed workers if some 6-digit NAICS are included in the less granular BLS estimates but are not, in reality, likely to use CCl₄ for the assessed applications. EPA addressed this issue by refining the OES estimates using total employment data from the U.S. Census' SUSB. However, this approach assumes that the distribution of occupation types (SOC codes) in each 6-digit NAICS is equal to the distribution of occupation types at the parent 5-digit NAICS level. If the distribution of workers in occupations with CCl₄ exposure differs from the overall distribution of workers in each NAICS, then this approach will result in inaccuracy.

Second, EPA's judgments about which industries (represented by NAICS codes) and occupations (represented by SOC codes) are associated with the uses assessed in this report are based on EPA's understanding of how CCl₄ is used in each industry. Designations of which industries and occupations have potential exposures is nevertheless subjective, and some industries/occupations with few exposures might erroneously be included, or some industries/occupations with exposures might erroneously be excluded. This would result in inaccuracy but would be unlikely to systematically either overestimate or underestimate the count of exposed workers.

3.2.2 Analysis of Exposure Monitoring Data

This report uses existing worker exposure monitoring data to assess exposure to CCl₄ during all conditions of use. Some data sources may be inherently biased. For example, bias may be present if exposure monitoring was conducted to address concerns regarding adverse human health effects reported following exposures during use.

Some scenarios have limited exposure monitoring data in literature, if any. Where there are few data points available, it is unlikely the results will be representative of worker exposure across the industry.

Where sufficient data were available, the 95th and 50th percentile exposure concentrations were calculated using available data. The 95th percentile exposure concentration is intended to represent a high-end exposure level, while the 50th percentile exposure concentration represents typical exposure level. The underlying distribution of the data, and the representativeness of the available data, are not

known. Where discrete data was not available, EPA used reported statistics (i.e., median, mean, 90th percentile, etc.). Since EPA could not verify these values, there is an added level of uncertainty.

EPA calculated ADC and LADC values assuming a high-end exposure duration of 250 days per year over 40 years and a typical exposure duration of 250 days per year over 31 years. This assumes the workers and occupational non-users are regularly exposed during their entire working lifetime, which likely results in an overestimate. Individuals may change jobs during the course of their career such that they are no longer exposed to CCl₄, and that actual ADC and LADC values become lower than the estimates presented.

3.2.1 Modeling Inhalation Exposures

The following describe uncertainties and simplifying assumptions generally associated with the modeling approach:

- There is some degree of uncertainty associated with each model input parameter. In general, the model inputs were determined based on review of available literature. Where the distribution of the input parameter is known, a distribution is assigned to capture uncertainty in the Monte Carlo analysis. Where the distribution is unknown, a uniform distribution is often used. The use of a uniform distribution will capture the low-end and high-end values but may not accurately reflect actual distribution of the input parameters.
- The exposure models represent model workplace settings for each CCl₄ condition of use. The models have not been regressed or fitted with monitoring data.

Each subsequent section below discusses uncertainties associated with the individual model.

3.2.1.1 Tank Truck and Railcar Loading and Unloading Release and Inhalation Exposure Model

For the import and repackaging, industrial processing aid, additive, and waste handling, disposal, treatment, and recycling conditions of uses, the Tank Truck and Railcar Loading and Unloading Release and Inhalation Exposure Model is used to estimate the airborne concentration associated with generic chemical loading scenarios at industrial facilities. Specific uncertainties associated with this model are described below:

- After each loading event, the model assumes saturated air containing CCl₄ that remains in the transfer hose and/or loading arm is released to air. The model calculates the quantity of saturated air using design dimensions of loading systems published in the OPW Engineered Systems catalog and engineering judgment. These dimensions may not be representative of the whole range of loading equipment used at industrial facilities handling CCl₄.
- The model estimates fugitive emissions from equipment leaks using total organic compound emission factors from EPA's Protocol for Equipment Leak Emission Estimates (U.S. EPA, 1995), and engineering judgement on the likely equipment type used for transfer (e.g. number of valves, seals, lines, and connections). The applicability of these emission factors to CCl₄, and the accuracy of EPA's assumption on equipment type are not known.
- The model assumes the use of a vapor balance system to minimize fugitive emissions. Although most industrial facilities are likely to use a vapor balance system when loading/unloading volatile chemicals, EPA does not know whether these systems are used by all facilities that potentially handle CCl₄.

- The model does not account for other potential sources of exposure at industrial facilities, such as sampling, equipment cleaning, and other process activities that can contribute to a worker's overall 8-hr daily exposure. These model uncertainties could result in an underestimate of the worker 8-hr exposure.

3.2.2 Modeling Dermal Exposures

To assess dermal exposure, EPA used a modified equation from the *EPA/OPPT 2-Hand Dermal Exposure to Liquids Model* to calculate the dermal absorbed dose for both non-occluded and occluded scenarios. The *Dermal Exposure to Volatile Liquids Model* is used to estimate dermal exposure to carbon tetrachloride in occupational settings. The model assumes a fixed fractional absorption of the applied dose; however, fractional absorption may be dependent on skin loading conditions. The model also assumes a single exposure event per day based on existing framework of the *EPA/OPPT 2-Hand Dermal Exposure to Liquids Model* and does not address variability in exposure duration and frequency. The model also incorporates a “protection factor (PF)” to account for glove use. PF values will vary depending on the type of glove used and the presence of employee training program. More details on the dermal methodology are discussed in Appendix E.

REFERENCES

- ATSDR. (2005). Toxicological profile for carbon tetrachloride (CAS# 56–23–5) [ATSDR Tox Profile]. Atlanta, GA: U.S. Department of Health and Human Services, Public Health Service. <http://www.atsdr.cdc.gov/toxprofiles>
- Baldwin, PE; Maynard, AD. (1998). A survey of wind speed in indoor workplaces. *Ann Occup Hyg* 42: 303-313. [http://dx.doi.org/10.1016/S0003-4878\(98\)00031-3](http://dx.doi.org/10.1016/S0003-4878(98)00031-3)
- CalRecycle. (2018). Beyond 2000: California's Continuing Need for Landfills [Website]. <https://www.calrecycle.ca.gov/SWFacilities/Landfills/NeedFor>
- Cherrie, JW; Semple, S; Brouwer, D. (2004). Gloves and Dermal Exposure to Chemicals: Proposals for Evaluating Workplace Effectiveness. *Ann Occup Hyg* 48: 607-615. <http://dx.doi.org/10.1093/annhyg/meh060>
- Dancik, Y; Bigliardi, PL; Bigliardi-Qi, Me. (2015). What happens in the skin? Integrating skin permeation kinetics into studies of developmental and reproductive toxicity following topical exposure. *Reprod Toxicol* 58: 252-281. <http://dx.doi.org/10.1016/j.reprotox.2015.10.001>
- DOEHRS-IH (Defense Occupational and Environmental Health Readiness System - Industrial Hygiene). (2018). Email between DOD and EPA: RE: [Non-DoD Source] Update: DoD exposure data for EPA risk evaluation - EPA request for additional information. Washington, D.C.: U.S. Department of Defense.
- EDF (Environmental Defense Fund) (2020). Environmental Defense Fund Comments for Toxic Substances Control Act (TSCA) Science Advisory Committee on Chemicals Review of the Draft Risk Evaluation of Carbon Tetrachloride. <https://beta.regulations.gov/document/EPA-HQ-OPPT-2019-0499-0026>
- ETC (Environmental Technology Council). (2018). High Temperature Incineration. <http://etc.org/advanced-technologies/high-temperature-incineration.aspx>.
- Frasch, FH. (2012). Dermal Absorption of Finite doses of Volatile Compounds. *J Pharm Sci* 101: 2616-2619. <http://dx.doi.org/https://doi.org/10.1002/jps.23149>
- Frasch, HF; Bunge, AL. (2015). The transient dermal exposure II: post-exposure absorption and evaporation of volatile compounds. *J Pharm Sci* 104: 1499-1507. <http://dx.doi.org/10.1002/jps.24334>
- Frasch, HF; Dotson, GS; Barbero, AM. (2011). In vitro human epidermal penetration of 1-bromopropane. *J Toxicol Environ Health A* 74: 1249-1260. <http://dx.doi.org/10.1080/15287394.2011.595666>
- Garrod, AN; Phillips, AM; Pemberton, JA. (2001). Potential exposure of hands inside protective gloves—a summary of data from non-agricultural pesticide surveys. *Ann Occup Hyg* 45: 55-60. [http://dx.doi.org/10.1016/S0003-4878\(00\)00013-2](http://dx.doi.org/10.1016/S0003-4878(00)00013-2)
- Gilles, D; Lybarger, J. (1978). Health hazard evaluation determination report no. HE 77-111-501, Allied Chemical Corporation, Danville, Illinois, June 1978. (HE 77-111-501). Cincinnati, OH: National Institute for Occupational Safety and Health. <https://www.cdc.gov/niosh/nioshtic-2/00099473.html>
- Ghittori, S; Saretto, G; Imbriani, M. (1994). Biological monitoring of workers exposed to carbon tetrachloride vapor. *Appl Occup Environ Hyg* 9: 353-357. <http://dx.doi.org/https://doi.org/10.1080/1047322X.1994.10388326>
- Graul, F. (2013). Comment submitted by Faye Graul, Executive Director, Halogenated Solvents Industry Alliance, Inc. <https://www.regulations.gov/document?D=EPA-HQ-OPPT-2012-0725-0013>
- Heritage. (2018). Incineration. <https://www.heritage-enviro.com/services/incineration/>

- [Hoag, H.](#) (2016). The Greening of Chemistry.
- [Holbrook, MT.](#) (2000). Carbon tetrachloride. In Kirk-Othmer Encyclopedia of Chemical Technology. Hoboken, NJ: John Wiley and Sons, Inc.
- [Holbrook, MT.](#) (2003). Methylene chloride. In Kirk-Othmer Encyclopedia of Chemical Technology (4th ed.). New York, NY: John Wiley & Sons.
<http://dx.doi.org/10.1002/0471238961.1305200808151202.a02.pub2>
- [Holbrook, MT.](#) (2004). Chloroform. In DF Othmer; RE Kirk (Eds.), Kirk-Othmer encyclopedia of chemical technology: Volume 6 (5th ed., pp. 279-290). New York, NY: John Wiley & Sons.
- [Holmes, L.](#) (2017). Comment submitted by Laurie Holmes, Senior Director, Environmental Policy, Motor & Equipment Manufacturers Association (MEMA).
<https://www.regulations.gov/document?D=EPA-HQ-OPPT-2016-0723-0017>
- [HSIA.](#) (2019). HSIA comments to U.S. EPA. (EPA-HQ-OPPT-2016-0773).
- [Kasting, BG; Miller, MA.](#) (2006). Kinetics of finite dose absorption through skin 2: Volatile compounds. J Pharm Sci 95: 268-280. <http://dx.doi.org/10.1002/jps.20497>
- [Kim, EA; Bernard, BP; Esswein, EJ.](#) (2005). Health hazard evaluation report no.HETA 2004-0169-2982, U.S. Mangesium, Rowley, Utah. (HETA 2004-0169-2982). Cincinnati, OH: National Institute for Occupational Safety and Health. <https://www.cdc.gov/niosh/hhe/reports/pdfs/2004-0169-2982.pdf>
- [Kitto, JBSStSC.](#) (1992). Steam: Its Generation and Use. In JBSSC Kitto (Ed.), (40th ed.). Barberton, Ohio: The Babcock & Wilcox Company.
- [Krock, R.](#) (2017). Comment submitted by Richard Krock, Vice President, Regulatory and Technical Affairs, The Vinyl Institute (VI), Part 2. Available online at
<https://www.regulations.gov/document?D=EPA-HQ-OPPT-2016-0733-0027>
- [MacRoy, P.](#) (2017). Comment submitted by Patrick MacRoy, Safer Chemicals, Healthy Families (SCHF), Environmental Health Strategy Center and Healthy Building Network, Part 2. Available online at <https://www.regulations.gov/document?D=EPA-HQ-OPPT-2016-0733-0023>
- [Marquart, H; Franken, R; Goede, H; Fransman, W; Schinkel, J.](#) (2017). Validation of the dermal exposure model in ECETOC TRA. Ann Work Expo Health 61: 854-871.
<http://dx.doi.org/10.1093/annweh/wxx059>
- [Marshall, KA; Pottenger, LH.](#) (2016). Chlorocarbons and chlorohydrocarbons. In Kirk-Othmer Encyclopedia of Chemical Technology (4th ed.). New York, NY: John Wiley & Sons.
- [O.P.W. Engineered Systems.](#) (2014). Loading Systems Catalog. OPW Engineered Systems: A Dover Company. ES-LS-6/15-2M; Uploaded November 18, 2014. OPW Engineered Systems.
http://www.opwglobal.com/docs/libraries/sales-literature/chemical-industrial/engineered-systems/brochures/opw-es-loading_systems_cat.pdf?sfvrsn=6
- [OECD.](#) (2010). Emission Scenario Document on Photoresist Use in Semiconductor Manufacturing. Paris: OECD Environmental Health and Safety Publications.
<http://dx.doi.org/10.1787/9789264221161-en>
- [OECD.](#) (2015). Emission scenario document (ESD) on chemical vapour deposition in the semiconductor industry. Paris, France: Organisation for Economic Co-operation and Development, OECD Environment Directorate, Environment, Health and Safety Division.
[http://www.oecd.org/officialdocuments/publicdisplaydocumentpdf/?cote=ENV/JM/MONO\(2015\)5&doclanguage=en](http://www.oecd.org/officialdocuments/publicdisplaydocumentpdf/?cote=ENV/JM/MONO(2015)5&doclanguage=en)
- [Riegle, L.](#) (2017). Comment submitted by Leslie Riegle, Director, Environmental Policy, Aerospace Industries Association (AIA). Available online at
<https://www.regulations.gov/document?D=EPA-HQ-OPPT-2016-0733-0011>

- [Tomer, A; Kane, J.](#) (2015). The great port mismatch. U.S. goods trade and international transportation. The Global Cities Initiative. A joint project of Brookings and JPMorgan Chase.
<https://www.brookings.edu/wp-content/uploads/2015/06/brgkssrvygcifreightnetworks.pdf>
- [U.S. BLS.](#) (2014). Employee Tenure News Release.
http://www.bls.gov/news.release/archives/tenure_09182014.htm
- [U.S. BLS.](#) (2015). Hours and Employment by Industry Tables - August 3, 2017 [Website].
<http://www.bls.gov/lpc/tables.htm>
- [U.S. BLS.](#) (2016). May 2016 Occupational Employment and Wage Estimates: National Industry-Specific Estimates [Website]. <http://www.bls.gov/oes/tables.htm>
- [U.S. Census Bureau.](#) (2015). Statistics of U.S. Businesses (SUSB).
<https://www.census.gov/data/tables/2015/econ/susb/2015-susb-annual.html>
- [U.S. Census Bureau.](#) (2019a). Survey of Income and Program Participation data [Website].
<https://www.census.gov/programs-surveys/sipp/data/datasets/2008-panel/wave-1.html>
- [U.S. Census Bureau.](#) (2019b). Survey of Income and Program Participation: SIPP introduction and history. Washington, DC. <https://www.census.gov/programs-surveys/sipp/about/sipp-introduction-history.html>
- [U.S. EPA.](#) (1980). Chapter 4.7: Waste Solvent Reclamation. In AP-42 Compilation of air pollutant emission factors (5th ed.). Research Triangle Park, NC: U.S. Environmental Protection Agency, Office of Air and Radiation, Office of Air Quality and Planning Standards.
<https://www3.epa.gov/ttn/chief/ap42/ch04/index.html>
- [U.S. EPA.](#) (1983). Preliminary Study of Sources of Carbon Tetrachloride: Final Report. (GCA-TR-CH-83-07). Research Triangle Park, NC: U.S. Environmental Protection Agency, Office of Air Quality Planning and Standards.
<https://nepis.epa.gov/Exe/ZyNET.exe/9100KSDS.TXT?ZyActionD=ZyDocument&Client=EPA&Index=1981+Thru+1985&Docs=&Query=&Time=&EndTime=&SearchMethod=1&TocRestrict=n&Toc=&TocEntry=&QField=&QFieldYear=&QFieldMonth=&QFieldDay=&IntQFieldOp=0&ExtQFieldOp=0&XmlQuery=&File=D%3A%5Czyfiles%5CIndex%20Data%5C81thru85%5CTxt%5C00000018%5C9100KSDS.txt&User=ANONYMOUS&Password=anonymous&SortMethod=h%7C-&MaximumDocuments=1&FuzzyDegree=0&ImageQuality=r75g8/r75g8/x150y150g16/i425&Display=hpfr&DefSeekPage=x&SearchBack=ZyActionL&Back=ZyActionS&BackDesc=Results%20page&MaximumPages=1&ZyEntry=1&SeekPage=x&ZyPURL>
- [U.S. EPA.](#) (1992). Guidelines for Exposure Assessment [EPA Report]. In Risk Assessment Forum. (EPA/600/Z-92/001). Washington, DC: U. S. Environmental Protection Agency.
<https://cfpub.epa.gov/ncea/risk/recordisplay.cfm?deid=15263>
- [U.S. EPA.](#) (1994a). Guidelines for Statistical Analysis of Occupational Exposure Data: Final. United States Environmental Protection Agency :: U.S. EPA.
- [U.S. EPA.](#) (1994b). National Emission Standards for Hazardous Air Pollutants from the Synthetic Organic Chemical Manufacturing Industry for Process Vents, Storage Vessels, Transfer Operations, and Wastewater. (40 C.F.R. §§ 63.110 and 63.126-130). Washington, DC.
- [U.S. EPA.](#) (1995). Protocol for Equipment Leak Emission Estimates. (EPA-453/R-95-017). Research Triangle Park, NC: Office of Air and Radiation, Office of Air Quality and Planning Standards.
<https://www3.epa.gov/ttn/chief/efdocs/equiplks.pdf>
- [U.S. EPA.](#) (2001). Risk assessment guidance for superfund: Volume III - Part A, Process for conducting probabilistic risk assessment [EPA Report]. (EPA 540-R-02-002). Washington, DC: U.S. Environmental Protection Agency, Office of Emergency and Remedial Response.

- [U.S. EPA](#). (2011). Exposure factors handbook: 2011 edition [EPA Report]. (EPA/600/R-090/052F). Washington, DC. <http://cfpub.epa.gov/ncea/cfm/recordisplay.cfm?deid=236252>
- [U.S. EPA](#). (2013). ChemSTEER User Guide: 2-Hand Dermal Exposure to Liquids Model. https://www.epa.gov/sites/production/files/2015-05/documents/user_guide.pdf
- [U.S. EPA](#). (2015a). AP-42: Compilation of Air Pollutant Emissions Factors. Fifth Edition, Volume I; Chapter 5: Petroleum Industry. Research Triangle Park, NC: Office of Air and Radiation, Office of Air Quality and Planning Standards. <https://www3.epa.gov/ttn/chief/ap42/ch05/index.html>
- [U.S. EPA](#). (2015b). ChemSTEER user guide - Chemical screening tool for exposures and environmental releases. Washington, D.C. https://www.epa.gov/sites/production/files/2015-05/documents/user_guide.pdf
- [U.S. EPA](#). (2016a). Instructions for reporting 2016 TSCA chemical data reporting. (EPA/600/R-09/052F). Washington, DC: U.S. Environmental Protection Agency, Office of Pollution Prevention and Toxics. <https://www.epa.gov/chemical-data-reporting/instructions-reporting-2016-tsca-chemical-data-reporting>
- [U.S. EPA](#). (2017a). Learn the Basics of Hazardous Waste. <https://www.epa.gov/hw/learn-basics-hazardous-waste>
- [U.S. EPA](#). (2017b). Preliminary information on manufacturing, processing, distribution, use, and disposal: Carbon tetrachloride [Comment]. Washington, DC. <https://www.regulations.gov/document?D=EPA-HQ-OPPT-2016-0733-0003>
- [U.S. EPA](#). (2018a). Application of systematic review in TSCA risk evaluations. (740-P1-8001). Washington, DC: U.S. Environmental Protection Agency, Office of Chemical Safety and Pollution Prevention. https://www.epa.gov/sites/production/files/2018-06/documents/final_application_of_sr_in_tsca_05-31-18.pdf
- [U.S. EPA](#). (2018b). Hazardous Waste Management Facilities and Units. <https://www.epa.gov/hwpermitting/hazardous-waste-management-facilities-and-units>
- [U.S. EPA](#). (2018c). Problem formulation of the risk evaluation for carbon tetrachloride (methane, tetrachloro-). (EPA-740-R1-7020). Washington, DC: Office of Chemical Safety and Pollution Prevention, United States Environmental Protection Agency. https://www.epa.gov/sites/production/files/2018-06/documents/ccl4_problem_formulation_05-31-18.pdf
- [U.S. EPA](#). (2018d). TRI Reporting Forms and Instructions (RFI) Guidance Document. https://ofmpub.epa.gov/apex/guideme_ext/f?p=guideme_ext:41:0::NO::
- [UNEP/Ozone Secretariat](#). (1998). The Montreal protocol on substances that deplete the ozone layer. Tenth meeting of the parties (Cairo, 23-24 November 1998). Decision X/14: Process agents. In Handbook for the Montreal Protocol on Substances that Deplete the Ozone Layer. (Decision X/14: Process Agents). Nairobi, Kenya. <http://ozone.unep.org/en/handbook-montreal-protocol-substances-deplete-ozone-layer/706>
- [Weil, ED; Sandler, SR; Gernon, M.](#) (2006). Sulfur compounds. In Kirk-Othmer Encyclopedia of Chemical Technology. New York, NY: John Wiley & Sons. <http://dx.doi.org/10.1002/0471238961.1921120623050912.a01.pub2>

APPENDICES

Appendix A Approach for Estimating Number of Workers and Occupational Non-Users

This appendix summarizes the methods that EPA used to estimate the number of workers who are potentially exposed to CCl₄ in each of its conditions of use. The method consists of the following steps:

1. Identify the North American Industry Classification System (NAICS) codes for the industry sectors associated with each condition of use.
2. Estimate total employment by industry/occupation combination using the Bureau of Labor Statistics' Occupational Employment Statistics (OES) data ([U.S. BLS, 2016](#)).
3. Refine the OES estimates where they are not sufficiently granular by using the U.S. Census Bureau ([2015](#)) Statistics of U.S. Businesses (SUSB) data on total employment by 6-digit NAICS .
4. Estimate the percentage of employees likely to be using CCl₄ instead of other chemicals (i.e., the market penetration of CCl₄ in the condition of use).
5. Estimate the number of sites and number of potentially exposed employees per site.
6. Estimate the number of potentially exposed employees within the condition of use.

Step 1: Identifying Affected NAICS Codes

As a first step, EPA identified NAICS industry codes associated with each condition of use. EPA generally identified NAICS industry codes for a condition of use by:

- Querying the [U.S. Census Bureau's NAICS Search tool](#) using keywords associated with each condition of use to identify NAICS codes with descriptions that match the condition of use.
- Referencing EPA/OPPT Generic Scenarios (GS's) and Organisation for Economic Co-operation and Development (OECD) Emission Scenario Documents (ESDs) for a condition of use to identify NAICS codes cited by the GS or ESD.
- Reviewing Chemical Data Reporting (CDR) data for the chemical, identifying the industrial sector codes reported for downstream industrial uses, and matching those industrial sector codes to NAICS codes using Table D-2 provided in the [CDR reporting instructions](#).

Each condition of use section in the main body of this report identifies the NAICS codes EPA identified for the respective condition of use.

Step 2: Estimating Total Employment by Industry and Occupation

U.S. BLS ([2016](#)) OES data provide employment data for workers in specific industries and occupations . The industries are classified by NAICS codes (identified previously), and occupations are classified by Standard Occupational Classification (SOC) codes.

Among the relevant NAICS codes (identified previously), EPA reviewed the occupation description and identified those occupations (SOC codes) where workers are potentially exposed to CCl₄. XX shows the SOC codes EPA classified as occupations potentially exposed to CCl₄. These occupations are classified

into workers (W) and occupational non-users (O). All other SOC codes are assumed to represent occupations where exposure is unlikely.

Table_Apx A-1. SOCs with Worker and ONU Designations for All Conditions of Use Except Dry Cleaning

SOC	Occupation	Designation
11-9020	Construction Managers	O
17-2000	Engineers	O
17-3000	Drafters, Engineering Technicians, and Mapping Technicians	O
19-2031	Chemists	O
19-4000	Life, Physical, and Social Science Technicians	O
47-1000	Supervisors of Construction and Extraction Workers	O
47-2000	Construction Trades Workers	W
49-1000	Supervisors of Installation, Maintenance, and Repair Workers	O
49-2000	Electrical and Electronic Equipment Mechanics, Installers, and Repairers	W
49-3000	Vehicle and Mobile Equipment Mechanics, Installers, and Repairers	W
49-9010	Control and Valve Installers and Repairers	W
49-9020	Heating, Air Conditioning, and Refrigeration Mechanics and Installers	W
49-9040	Industrial Machinery Installation, Repair, and Maintenance Workers	W
49-9060	Precision Instrument and Equipment Repairers	W
49-9070	Maintenance and Repair Workers, General	W
49-9090	Miscellaneous Installation, Maintenance, and Repair Workers	W
51-1000	Supervisors of Production Workers	O
51-2000	Assemblers and Fabricators	W
51-4020	Forming Machine Setters, Operators, and Tenders, Metal and Plastic	W
51-6010	Laundry and Dry-Cleaning Workers	W
51-6020	Pressers, Textile, Garment, and Related Materials	W
51-6030	Sewing Machine Operators	O
51-6040	Shoe and Leather Workers	O
51-6050	Tailors, Dressmakers, and Sewers	O
51-6090	Miscellaneous Textile, Apparel, and Furnishings Workers	O
51-8020	Stationary Engineers and Boiler Operators	W
51-8090	Miscellaneous Plant and System Operators	W
51-9000	Other Production Occupations	W

W = worker designation

O = ONU designation

For dry cleaning facilities, due to the unique nature of work expected at these facilities and that different workers may be expected to share among activities with higher exposure potential (e.g., unloading the dry cleaning machine, pressing/finishing a dry cleaned load), EPA made different SOC code worker and

ONU assignments for this condition of use. XX summarizes the SOC codes with worker and ONU designations used for dry cleaning facilities.

Table Apx A-2. SOCs with Worker and ONU Designations for Dry Cleaning Facilities

SOC	Occupation	Designation
41-2000	Retail Sales Workers	O
49-9040	Industrial Machinery Installation, Repair, and Maintenance Workers	W
49-9070	Maintenance and Repair Workers, General	W
49-9090	Miscellaneous Installation, Maintenance, and Repair Workers	W
51-6010	Laundry and Dry-Cleaning Workers	W
51-6020	Pressers, Textile, Garment, and Related Materials	W
51-6030	Sewing Machine Operators	O
51-6040	Shoe and Leather Workers	O
51-6050	Tailors, Dressmakers, and Sewers	O
51-6090	Miscellaneous Textile, Apparel, and Furnishings Workers	O

W = worker designation

O = ONU designation

After identifying relevant NAICS and SOC codes, EPA used BLS data to determine total employment by industry and by occupation based on the NAICS and SOC combinations. For example, there are 110,640 employees associated with 4-digit NAICS 8123 (*Drycleaning and Laundry Services*) and SOC 51-6010 (*Laundry and Dry-Cleaning Workers*).

Using a combination of NAICS and SOC codes to estimate total employment provides more accurate estimates for the number of workers than using NAICS codes alone. Using only NAICS codes to estimate number of workers typically result in an overestimate, because not all workers employed in that industry sector will be exposed. However, in some cases, BLS only provide employment data at the 4-digit or 5-digit NAICS level; therefore, further refinement of this approach may be needed (see next step).

Step 3: Refining Employment Estimates to Account for lack of NAICS Granularity

The third step in EPA’s methodology was to further refine the employment estimates by using total employment data in the U.S. Census Bureau (2015) SUSB. In some cases, BLS OES’s occupation-specific data are only available at the 4-digit or 5-digit NAICS level, whereas the SUSB data are available at the 6-digit level (but are not occupation-specific). Identifying specific 6-digit NAICS will ensure that only industries with potential CCl₄ exposure are included. As an example, OES data are available for the 4-digit NAICS 8123 *Drycleaning and Laundry Services*, which includes the following 6-digit NAICS:

- NAICS 812310 Coin-Operated Laundries and Drycleaners;
- NAICS 812320 Drycleaning and Laundry Services (except Coin-Operated);
- NAICS 812331 Linen Supply; and
- NAICS 812332 Industrial Launderers.

In this example, only NAICS 812320 is of interest. The Census data allow EPA/OPPT to calculate employment in the specific 6-digit NAICS of interest as a percentage of employment in the BLS 4-digit NAICS.

The 6-digit NAICS 812320 comprises 46 percent of total employment under the 4-digit NAICS 8123. This percentage can be multiplied by the occupation-specific employment estimates given in the BLS OES data to further refine our estimates of the number of employees with potential exposure.

Table_Apx A-3 illustrates this granularity adjustment for NAICS 812320.

Table Apx A-3. Estimated Number of Potentially Exposed Workers and ONUs under NAICS 812320

NAICS	SOC CODE	SOC Description	Occupation Designation	Employment by SOC at 4-digit NAICS level	% of Total Employment	Estimated Employment by SOC at 6-digit NAICS level
8123	41-2000	Retail Sales Workers	O	44,500	46.0%	20,459
8123	49-9040	Industrial Machinery Installation, Repair, and Maintenance Workers	W	1,790	46.0%	823
8123	49-9070	Maintenance and Repair Workers, General	W	3,260	46.0%	1,499
8123	49-9090	Miscellaneous Installation, Maintenance, and Repair Workers	W	1,080	46.0%	497
8123	51-6010	Laundry and Dry-Cleaning Workers	W	110,640	46.0%	50,867
8123	51-6020	Pressers, Textile, Garment, and Related Materials	W	40,250	46.0%	18,505
8123	51-6030	Sewing Machine Operators	O	1,660	46.0%	763
8123	51-6040	Shoe and Leather Workers	O	Not Reported for this NAICS Code		
8123	51-6050	Tailors, Dressmakers, and Sewers	O	2,890	46.0%	1,329
8123	51-6090	Miscellaneous Textile, Apparel, and Furnishings Workers	O	0	46.0%	0
Total Potentially Exposed Employees				206,070		94,740
Total Workers						72,190
Total Occupational Non-Users						22,551

Note: numbers may not sum exactly due to rounding.

W = worker

O = occupational non-user

Source: ([U.S. BLS, 2016](#); [U.S. Census Bureau, 2015](#))

Step 4: Estimating the Percentage of Workers Using CCl₄ Instead of Other Chemicals

In the final step, EPA accounted for the market share by applying a factor to the number of workers determined in Step 3. This accounts for the fact that CCl₄ may be only one of multiple chemicals used for the applications of interest. EPA did not identify market penetration data for any conditions of use. In the absence of market penetration data for a given condition of use, EPA assumed CCl₄ may be used

at up to all sites and by up to all workers calculated in this method as a bounding estimate. This assumes a market penetration of 100%. Market penetration is discussed for each condition of use in the main body of this report.

Step 5: Estimating the Number of Workers per Site

EPA calculated the number of workers and occupational non-users in each industry/occupation combination using the formula below (granularity adjustment is only applicable where SOC data are not available at the 6-digit NAICS level):

$$\text{Number of Workers or ONUs in NAICS/SOC (Step 2)} \times \text{Granularity Adjustment Percentage (Step 3)} = \text{Number of Workers or ONUs in the Industry/Occupation Combination}$$

EPA then estimated the total number of establishments by obtaining the number of establishments reported in the U.S. Census Bureau ([2015](#)) SUSB data at the 6-digit NAICS level .

EPA then summed the number of workers and occupational non-users over all occupations within a NAICS code and divided these sums by the number of establishments in the NAICS code to calculate the average number of workers and occupational non-users per site.

Step 6: Estimating the Number of Workers and Sites for a Condition of Use

EPA estimated the number of workers and occupational non-users potentially exposed to CCl₄ and the number of sites that use CCl₄ in a given condition of use through the following steps:

- 6.A. Obtaining the total number of establishments by:
 - i. Obtaining the number of establishments from SUSB data ([U.S. Census Bureau, 2015](#)) the 6-digit NAICS level (Step 5) for each NAICS code in the condition of use and summing these values; or
 - ii. Obtaining the number of establishments from the Toxics Release Inventory (TRI), Discharge Monitoring Report (DMR) data, National Emissions Inventory (NEI), or literature for the condition of use.
- 6.B. Estimating the number of establishments that use CCl₄ by taking the total number of establishments from Step 6.A and multiplying it by the market penetration factor from Step 4.
- 6.C. Estimating the number of workers and occupational non-users potentially exposed to CCl₄ by taking the number of establishments calculated in Step 6.B and multiplying it by the average number of workers and occupational non-users per site from Step 5.

Appendix B Equations for Calculating Chronic (Non-Cancer and Cancer) Inhalation Exposures

This report assesses CCl₄ exposures to workers in occupational settings, presented as 8-hr time weighted average (TWA) as well as 12-hr TWA. The 8-hr or 12-hr TWA exposures are then used to calculate average daily concentration (ADC) for chronic, non-cancer risks, and lifetime average daily concentration (LADC) for chronic, cancer risks.

ADC and LADC are used to estimate workplace chronic exposures for non-cancer and cancer risks, respectively. These exposures are estimated as follows:

Equation_Apx B-1

$$ADC \text{ or } LADC = \frac{C \times ED \times EF \times WY}{AT \text{ or } AT_c}$$

Where:

- ADC = average daily concentration (24-hr TWA) used for chronic non-cancer risk calculations
- LADC = lifetime average daily concentration (24-hr TWA) used for chronic cancer risk calculations
- C = contaminant concentration in air (8-hr TWA or 12-hr TWA)
- ED = exposure duration (denoted with “8” specifies 8 hr/day and “12” specifies 12 hr/day)
- EF = exposure frequency (250 days/yr)
- WY = exposed working years per lifetime (50th percentile = 31; 95th percentile = 40)
- AT = averaging time, non-cancer risks (WY × 365 days/yr × 24 hr/day)
- AT_c = averaging time, cancer risks (LT × 365 days/year × 24 hr/day; where LT = 78 years)

Table Apx B-1. Parameter Values for Calculating Inhalation Exposure Estimates

Parameter Name	Symbol	Value	Unit
Exposure Duration, 8-hr TWA	ED ₈	8	hr/day
Exposure Duration, 12-hr TWA	ED ₁₂	12	hr/day
Exposure Frequency	EF	250	days/year
Working Years	WY	31 (50 th percentile) 40 (95 th percentile)	years
Lifetime, cancer	LT	78	years
Averaging Time, non-cancer	AT	271,560 (CT) ^a 350,400 (HE) ^b	hr
Averaging Time, cancer	AT _c	683,280	hr

^a Calculated using the 50th percentile value for working years (WY)

^b Calculated using the 95th percentile value for working years (WY)

B.1 Exposure Duration (ED)

EPA uses an exposure duration of 8 hours (480 minutes) per day for 8-hr TWA and 12 hours (720 minutes) per day for 12-hr TWA.

B.2 Exposure Frequency (EF)

EPA uses an exposure frequency of 250 days per year. Exposure frequency (EF) is expressed as the number of days per year a worker is exposed to the chemical being assessed. In some cases, it may be reasonable to assume a worker is exposed to the chemical on each working day. In other cases, it may be more appropriate to estimate a worker's exposure to the chemical occurs during a subset of the worker's annual working days. The relationship between exposure frequency and annual working days can be described mathematically as follows:

Equation_Apx B-2

$$EF = f \times AWD$$

Where:

- EF = exposure frequency, the number of days per year a worker is exposed to the chemical (day/yr)
- f = fractional number of annual working days during which a worker is exposed to the chemical (unitless)

AWD = annual working days, the number of days per year a worker works (day/yr)

U.S. BLS (2015) provides data on the total number of hours worked and total number of employees by each industry NAICS code. These data are available from the 3- to 6-digit NAICS level (where 3-digit NAICS are less granular and 6-digit NAICS are the most granular). Dividing the total, annual hours worked by the number of employees yields the average number of hours worked per employee per year for each NAICS.

EPA has identified approximately 140 NAICS codes applicable to the multiple conditions of use for the ten chemicals undergoing risk evaluation. For each NAICS code of interest, EPA looked up the average hours worked per employee per year at the most granular NAICS level available (i.e., 4-digit, 5-digit, or 6-digit). EPA converted the working hours per employee to working days per year per employee assuming employees work an average of eight hours per day. The average number of days per year worked, or AWD, ranges from 169 to 282 days per year, with a 50th percentile value of 250 days per year. EPA repeated this analysis for all NAICS codes at the 4-digit level. The average AWD for all 4-digit NAICS codes ranges from 111 to 282 days per year, with a 50th percentile value of 228 days per year. 250 days per year is approximately the 75th percentile.

In the absence of industry- and CCl₄-specific data, EPA assumes the parameter f is equal to one for all conditions of use.

B.3 Working Years (WY)

EPA has developed a triangular distribution for working years. EPA has defined the parameters of the triangular distribution as follows:

- Minimum value: BLS CPS tenure data with current employer as a low-end estimate of the number of lifetime working years: 10.4 years;
- Mode value: The 50th percentile tenure data with all employers from Survey of Income and Program Participation (SIPP) as a mode value for the number of lifetime working years: 36 years; and
- Maximum value: The maximum average tenure data with all employers from SIPP as a high-end estimate on the number of lifetime working years: 44 years.

This triangular distribution has a 50th percentile value of 31 years and a 95th percentile value of 40 years. EPA uses these values for central tendency and high-end ADC and LADC calculations, respectively.

The U.S. BLS (2014) provides information on employee tenure with *current employer* obtained from the Current Population Survey (CPS). CPS is a monthly sample survey of about 60,000 households that provides information on the labor force status of the civilian non-institutional population age 16 and over; CPS data are released every two years. The data are available by demographics and by generic industry sectors but are not available by NAICS codes.

The U.S. Census (2019a) Survey of Income and Program Participation (SIPP) provides information on *lifetime tenure with all employers*. SIPP is a household survey that collects data on income, labor force participation, social program participation and eligibility, and general demographic characteristics

through a continuous series of national panel surveys of between 14,000 and 52,000 households ([U.S. Census Bureau, 2019b](#)). EPA analyzed the 2008 SIPP Panel Wave 1, a panel that began in 2008 and covers the interview months of September 2008 through December 2008 ([U.S. Census Bureau, 2019a, b](#)). For this panel, lifetime tenure data are available by Census Industry Codes, which can be cross-walked with NAICS codes.

SIPP data include fields for the industry in which each surveyed, employed individual works (TJBIND1), worker age (TAGE), and years of work experience *with all employers* over the surveyed individual’s lifetime.⁷ Census household surveys use different industry codes than the NAICS codes used in its firm surveys, so these were converted to NAICS using a published crosswalk ([U.S. Census Bureau, 2013](#)). EPA calculated the average tenure for the following age groups: 1) workers age 50 and older; 2) workers age 60 and older; and 3) workers of all ages employed at time of survey. EPA used tenure data for age group “50 and older” to determine the high-end lifetime working years, because the sample size in this age group is often substantially higher than the sample size for age group “60 and older”. For some industries, the number of workers surveyed, or the *sample size*, was too small to provide a reliable representation of the worker tenure in that industry. Therefore, EPA excluded data where the sample size is less than five from our analysis.

Table_Apx B-2 summarizes the average tenure for workers age 50 and older from SIPP data. Although the tenure may differ for any given industry sector, there is no significant variability between the 50th and 95th percentile values of average tenure across manufacturing and non-manufacturing sectors.

Table_Apx B-2. Overview of Average Worker Tenure from U.S. Census SIPP (Age Group 50+)

Industry Sectors	Working Years			
	Average	50 th Percentile	95 th Percentile	Maximum
All industry sectors relevant to the 10 chemicals undergoing risk evaluation	35.9	36	39	44
Manufacturing sectors (NAICS 31-33)	35.7	36	39	40
Non-manufacturing sectors (NAICS 42-81)	36.1	36	39	44

Source: ([U.S. Census Bureau, 2019b](#))

Note: Industries where sample size is less than five are excluded from this analysis.

BLS CPS data provides the median years of tenure that wage and salary workers had been with their current employer. Table_Apx B-3 presents CPS data for all demographics (men and women) by age group from 2008 to 2012. To estimate the low-end value on number of working years, EPA uses the most recent CPS data for workers age 55 to 64 years, which indicates a median tenure of 10.4 years with their current employer. The use of this low-end value represents a scenario where workers are only exposed to the chemical of interest for a portion of their lifetime working years, as they may change jobs or move from one industry to another throughout their career.

⁷ To calculate the number of years of work experience we took the difference between the year first worked (TMAKMNYR) and the current data year (i.e., 2008). We then subtracted any intervening months when not working (ETIMEOFF).

Table Apx B-3. Median Years of Tenure with Current Employer by Age Group

Age	January 2008	January 2010	January 2012	January 2014
16 years and over	4.1	4.4	4.6	4.6
16 to 17 years	0.7	0.7	0.7	0.7
18 to 19 years	0.8	1.0	0.8	0.8
20 to 24 years	1.3	1.5	1.3	1.3
25 years and over	5.1	5.2	5.4	5.5
25 to 34 years	2.7	3.1	3.2	3.0
35 to 44 years	4.9	5.1	5.3	5.2
45 to 54 years	7.6	7.8	7.8	7.9
55 to 64 years	9.9	10.0	10.3	10.4
65 years and over	10.2	9.9	10.3	10.3

Source: ([U.S. BLS, 2014](#))

B.4 Lifetime Years (LT)

EPA assumes a lifetime of 78 years for all worker demographics.

Appendix C Sample Calculations for Calculating Acute and Chronic (Non-Cancer and Cancer) Inhalation Exposures

Sample calculations for high-end (HE) and central tendency (CT) chronic exposure concentrations for one setting, manufacturing (using 8-hr TWA), are demonstrated below. The explanation of the equations and parameters used is provided in Appendix B.

C.1 Example High-End ADC and LADC

Calculate ADC_{HE} :

$$ADC_{HE} = \frac{C_{HE} \times ED \times EF \times WY}{AT}$$
$$ADC_{HE} = \frac{4.01 \frac{mg}{m^3} \times 8 \frac{hr}{day} \times 250 \frac{days}{year} \times 40 \text{ years}}{\left(40 \text{ years} \times 365 \frac{days}{year} \times 24 \frac{hours}{day}\right)} = 0.92 \frac{mg}{m^3}$$

Calculate $LADC_{HE}$:

$$LADC_{HE} = \frac{C_{HE} \times ED \times EF \times WY}{AT_{LADC}}$$
$$LADC_{HE} = \frac{4.01 \frac{mg}{m^3} \times 8 \frac{hr}{day} \times 250 \frac{days}{year} \times 40 \text{ years}}{\left(78 \text{ years} \times 365 \frac{days}{year} \times 24 \frac{hours}{day}\right)} = 0.47 \frac{mg}{m^3}$$

C.2 Example Central Tendency ADC and LADC

Calculate ADC_{CT} :

$$ADC_{CT} = \frac{C_{CT} \times ED \times EF \times WY}{AT_{ADC}}$$
$$ADC_{CT} = \frac{0.73 \frac{mg}{m^3} \times 8 \frac{hr}{day} \times 250 \frac{days}{year} \times 31 \text{ years}}{\left(31 \text{ years} \times 365 \frac{days}{year} \times 24 \frac{hours}{day}\right)} = 0.17 \frac{mg}{m^3}$$

Calculate $LADC_{CT}$:

$$LADC_{CT} = \frac{C_{CT} \times ED \times EF \times WY}{AT_{LADC}}$$

$$LADC_{CT} = \frac{0.73 \frac{mg}{m^3} \times 8 \frac{hr}{day} \times 250 \frac{days}{year} \times 31 \text{ years}}{\left(78 \text{ years} \times 365 \frac{days}{year} \times 24 \frac{hours}{day}\right)} = 0.07 \frac{mg}{m^3}$$

Appendix D Tank Truck and Railcar Loading and Unloading Release and Inhalation Exposure Model Methodology

This appendix presents the modeling approach and model equations used in the Tank Truck and Railcar Loading and Unloading Release and Inhalation Exposure Model. The model was developed through review of relevant literature and consideration of existing EPA exposure models. The model approach is a generic inhalation exposure assessment at industrial facilities that is applicable for any volatile chemical with the following conditions of use:

- Manufacture (loading of chemicals into containers);
- Processing as a reactant/intermediate (unloading of chemicals);
- Processing into formulation, mixture, or reaction products;
- Import (repackaging); and
- Other similar conditions of use at industrial facilities (e.g., industrial processing aid).

As an example, CCl₄ at a manufacturing facility is expected to be packaged and loaded into a container before distributing to another industrial processing or use site (e.g., formulation sites, sites using CCl₄ as an intermediate, and sites using CCl₄ as a processing aid). At the industrial processing or use site, CCl₄ is then unloaded from the container into a process vessel before being incorporated into a mixture, used as a chemical intermediate, or otherwise processed/used. For the model, EPA assumes CCl₄ is unloaded into tank trucks and railcars and transported and distributed in bulk. EPA also assumes the chemical is handled as a pure substance (100 percent concentration).

Because CCl₄ is volatile (vapor pressure above 0.01 torr at room temperature), fugitive emissions may occur when CCl₄ is loaded into or unloaded from a tank truck or railcar. Sources of these emissions include:

- Displacement of saturated air containing CCl₄ as the container/truck is filled with liquid;
- Emissions of saturated air containing CCl₄ that remains in the loading arm, transfer hose, and related equipment; and
- Emissions from equipment leaks from processing units such as pumps, seals and valves.

These emissions result in subsequent exposure to workers involved in the transfer activity. The following subsections address these emission sources.

D.1 Displacement of Saturated Air Inside Tank Trucks and Railcars

For screening-level assessments, EPA typically uses the EPA/OAQPS AP-42 Loading Model to conservatively assess exposure during container unloading activities ([U.S. EPA, 2015b](#)). The model estimates release to air from the displacement of air containing chemical vapor as a container/vessel is filled with liquid ([U.S. EPA, 2015b](#)). The model assumes the unloading activity displaces an air volume equal to the size of the container, and that displaced air is either 50 percent or 100 percent saturated with chemical vapor ([U.S. EPA, 2015b](#)).

Process units at facilities that manufacture CCl₄ as a primary product; use CCl₄ as a reactant or manufacture CCl₄ as a product or co-product; or are located at a plant that is a major source of hazardous air pollutants (HAPs) as defined in section 112(a) of the Clean Air Act are required to install

and operate a vapor capture system and control device (or vapor balancing system) for loading/unloading operations ([U.S. EPA, 1994b](#)). Therefore, EPA expects the majority of industrial facilities to use a vapor balance system to minimize fugitive emissions when loading and unloading tank trucks and railcars. As such, vapor losses from displacement of air is likely mitigated by the use of such systems. Actual fugitive emissions are likely limited to any saturated vapor that remain in the hose, loading arm, or related equipment after being disconnected from the truck or railcar. This emission source is addressed in the next subsection.

D.2 Emissions of Saturated Air that Remain in Transfer Hoses/Loading Arm

After loading is complete, transfer hoses and/or loading arms are disconnected from tank trucks and railcars. Saturated air containing the chemical of interest that remains in transfer equipment may be released to air, presenting a source of fugitive emissions. The quantity of CCl₄ released will depend on concentration in the vapor and the volume of vapor in the loading arm/hose/piping.

Table_Apx D-1 presents the dimensions for several types of loading systems according to an OPW Engineered Systems catalog ([O.P.W. Engineered Systems, 2014](#)). OPW Engineered Systems ([2014](#)) specializes in the engineering, designing, and manufacturing of systems for loading and unloading a wide range of materials including petroleum products, liquefied gases, asphalt, solvents, and hazardous and corrosive chemicals . These systems include loading systems, swivel joints, instrumentation, quick and dry-disconnect systems, and safety breakaways. Based on the design dimensions, the table presents the calculated total volume of loading arm/system and assumes the volume of vapor containing CCl₄ equals the volume of the loading arm/system.

Based on comments from HSIA ([2013](#)), halogenated solvents, such as CCl₄, are expected to be delivered in either tank trailers or tank cars. Therefore, EPA modeled the central tendency scenario as tank truck loading/unloading. EPA modeled the high-end scenario as railcar loading/unloading since railcars are larger and more likely to use longer transfer arms (and thus represent a higher exposure potential than tank trucks). To estimate the high-end transfer arm volume, EPA calculated the 95th percentile of the OPW Engineered Systems loading arms volumetric data resulting in a high-end value of 17.7 gallons. For the central tendency tank truck scenario, EPA assumed a 2-inch diameter, 12-ft long transfer hose. This hose has a volume of 2.0 gallons.

Once the volume is known, the emission rate, E_T (g/s), can be calculated as follows:

Equation_Apx D-1

$$E_T = \frac{f \times MW \times 3,786.4 \times V_h \times X \times VP}{t_{disconnect} \times T \times R \times 3,600 \times 760}$$

Default values for Equation_Apx D-1 can be found in Table_Apx D-2.

Table Apx D-1. Example Dimension and Volume of Loading Arm/Transfer System

OPW Engineered Systems Transfer Arm	Length of Loading Arm/Connection (in) ^a				Volume, V _h (gal) ^b			
	2-inch	3-inch	4-inch	6-inch	2-inch	3-inch	4-inch	6-inch
Unsupported Boom-Type Bottom Loader	149.875	158.5	165.25	191.75	2.0	4.9	9.0	23.5
“A” Frame Loader M-32-F	153.75	159.75	164.5	NA	2.1	4.9	8.9	NA
“A” Frame Hose Loader AFH-32-F	180.75	192.75	197.5	NA	2.5	5.9	10.7	NA
CWH Series Counterweighted Hose Loader	NA	NA	309	NA	NA	NA	16.8	NA
Spring Balanced Hose Loader SRH-32-F	204.75	216.75	221.5	NA	2.8	6.6	12.0	NA
Spring Balanced Hose Loader LRH-32-F	NA	270	277.625	NA	NA	8.3	15.1	NA
Top Loading Single Arm Fixed Reach	201.75	207.75	212.5	NA	2.7	6.4	11.6	NA
Top Loading Scissor Type Arm	197.875	206.5	213.25	NA	2.7	6.3	11.6	NA
Supported Boom Arm B-32-F	327.375	335	341.5	NA	4.5	10.3	18.6	NA
Unsupported Boom Arm GT-32-F	215.875	224.5	231.25	NA	2.9	6.9	12.6	NA
Slide Sleeve Arm A-32F	279	292.5	305.125	NA	3.8	9.0	16.6	NA
Hose without Transfer Arm								
Hose (EPA judgment)	120	--	--	--	1.6	--	--	--

Source: (O.P.W. Engineered Systems, 2014)

a – Total length includes length of piping, connections, and fittings.

b – Calculated based on dimension of the transfer hose/connection, $V_h = \pi r^2 L$ (converted from cubic inch to gallons).

Table_Apx D-2. Default Values for Calculating Emission Rate of Carbon Tetrachloride from Transfer/Loading Arm

Parameter	Parameter Description	Default Value	Unit
E _T	Emission rate of chemical from transfer/loading system	Calculated from model equation	g/s
f	Saturation factor ^a	1	dimensionless
MW	Molecular weight of the chemical	153.82	g/mol
V _h	Volume of transfer hose	See Table_Apx D-1	gallons
r	Fill rate ^a	2 (tank truck) 1 (railcar)	containers/hr
t _{disconnect}	Time to disconnect hose/couplers (escape of saturated vapor from disconnected hose or transfer arm into air)	0.25	hr
X	Vapor pressure correction factor	1	dimensionless
VP	Vapor pressure of the pure chemical	115	torr
T	Temperature	298	K
R	Universal gas constant	82.05	atm-cm ³ /gmol-K

a – Saturation factor and fill rate values are based on established EPA/OPPT release and inhalation exposure assessment methodologies (U.S. EPA, 2015, 3809033).

D.3 Emission from Leaks

During loading/unloading activities, emissions may also occur from equipment leaks from valves, pumps, and seals. Per EPA's *Chapter 5: Petroleum Industry* of AP-42 ([U.S. EPA, 2015a](#)) and EPA's *Protocol for Equipment Leak Emission Estimates* ([U.S. EPA, 1995](#)), the following equation can be used to estimate emission rate E_L, calculated as the sum of average emissions from each process unit:

Equation_Apx D-2

$$E_L = \sum (F_A \times W_{F_{TOC}} \times N) \times \frac{1,000}{3,600}$$

Parameters for calculating equipment leaks using Equation_Apx B-1 can be found in Table_Apx D-3.

Table_Apx D-3. Parameters for Calculating Emission Rate of Carbon Tetrachloride from Equipment Leaks

Parameter	Parameter Description	Default Value	Unit
E_L	Emission rate of chemical from equipment leaks	Calculated from model equation	g/s
F_A	Applicable average emission factor for the equipment type	See Table_Apx D-4	kg/hr-source
WF_{TOC}	Average weight fraction of chemical in the stream	1	dimensionless
N	Number of pieces of equipment of the applicable equipment type in the stream	See Table_Apx D-4	Source

To estimate emission leaks using this modeling approach, EPA modeled a central tendency loading rack scenario using tank truck loading/unloading and a high-end loading rack scenario using railcar loading/unloading as discussed in Appendix D.2. EPA used engineering judgment to estimate the type and number of equipment associated with the loading rack in the immediate vicinity of the loading operation. EPA assumes at least one worker will be near the loading rack during the entire duration of the loading operation.

Table_Apx D-4 presents the average emission factor for each equipment type, based on the synthetic organic chemical manufacturing industry (SOCMI) emission factors as provided by EPA's 1995 Protocol ([U.S. EPA, 1995](#)), and the likely number of pieces of each equipment used for each chemical loading/unloading activity, based on EPA's judgment. Note these emission factors are for emission rates of total organic compound emission and are assumed to be applicable to CCl₄. In addition, these factors are most valid for estimating emissions from a population of equipment and are not intended to be used to estimate emissions for an individual piece of equipment over a short period of time.

Table Apx D-4. Default Values for F_A and N

Equipment Type	Service	SOCMI Emission Factor, F _A (kg/hr-source) ^a	Number of Equipment, N (central tendency)	Number of Equipment, N (high-end)
Valves	Gas	0.00597	3 (gas)	3 (gas)
	Light liquid	0.00403	5 (light liquid)	10 (light liquid)
	Heavy liquid	0.00023	--	--
Pump seals ^b	Light liquid	0.0199	--	--
	Heavy liquid	0.00862	--	--
Compressor seals	Gas	0.228	--	--
Pressure relief valves	Gas	0.104	1	1
Connectors	All	0.00183	2	3
Open-ended lines	All	0.0017	--	--
Sampling connections	All	0.015	2	3

Source: (U.S. EPA, 1995)

^a – SOCMI average emission factors for total organic compounds from EPA’s 1995 Protocol (U.S. EPA, 1995). “Light liquid” is defined as “material in a liquid state in which the sum of the concentration of individual constituents with a vapor pressure over 0.3 kilopascals (kPa) at 20 °C is greater than or equal to 20 weight percent”. “Heavy liquid” is defined as “not in gas/vapor service or light liquid service.” Since CCl₄ has a vapor pressure of 115 mmHg (15.33 kPa) at 25 °C, EPA modeled CCl₄ liquid as a light liquid.

^b – The light liquid pump seal factor can be used to estimate the leak rate from agitator seals.

EPA assumed the following equipment are used in loading racks for the loading/unloading of tank trucks and railcars. Figure_Apx D-1 illustrates an example tank truck and unloading rack equipment.

- Tank Truck Loading/Unloading:
 - Liquid Service:
 - Four valves (modeled as valves in light liquid service)
 - One safety relief valve (modeled as valve in light liquid service)
 - One bleed valve or sampling connection
 - One hose connector
 - Vapor Service:
 - Three valves (modeled as valves in gas service)
 - One pressure relief valve
 - One bleed valve (modeled as a sampling connection)
 - One hose connector
- Railcar Loading/Unloading
 - Liquid Service: EPA assumed, for the high-end scenario, two parallel liquid service lines, each using the same equipment as assumed for tank trucks. Therefore, a total of:
 - Eight valves (modeled as valves in light liquid service)
 - Two safety relief valves (modeled as valve in light liquid service)
 - Two bleed valves or sampling connections
 - Two transfer arm connectors

- Vapor Service: EPA assumed a single line in vapor service with the same equipment as assumed for tank trucks.
 - Three valves (modeled as valves in gas service)
 - One pressure relief valve
 - One bleed valve (modeled as a sampling connection)
 - One transfer arm connector

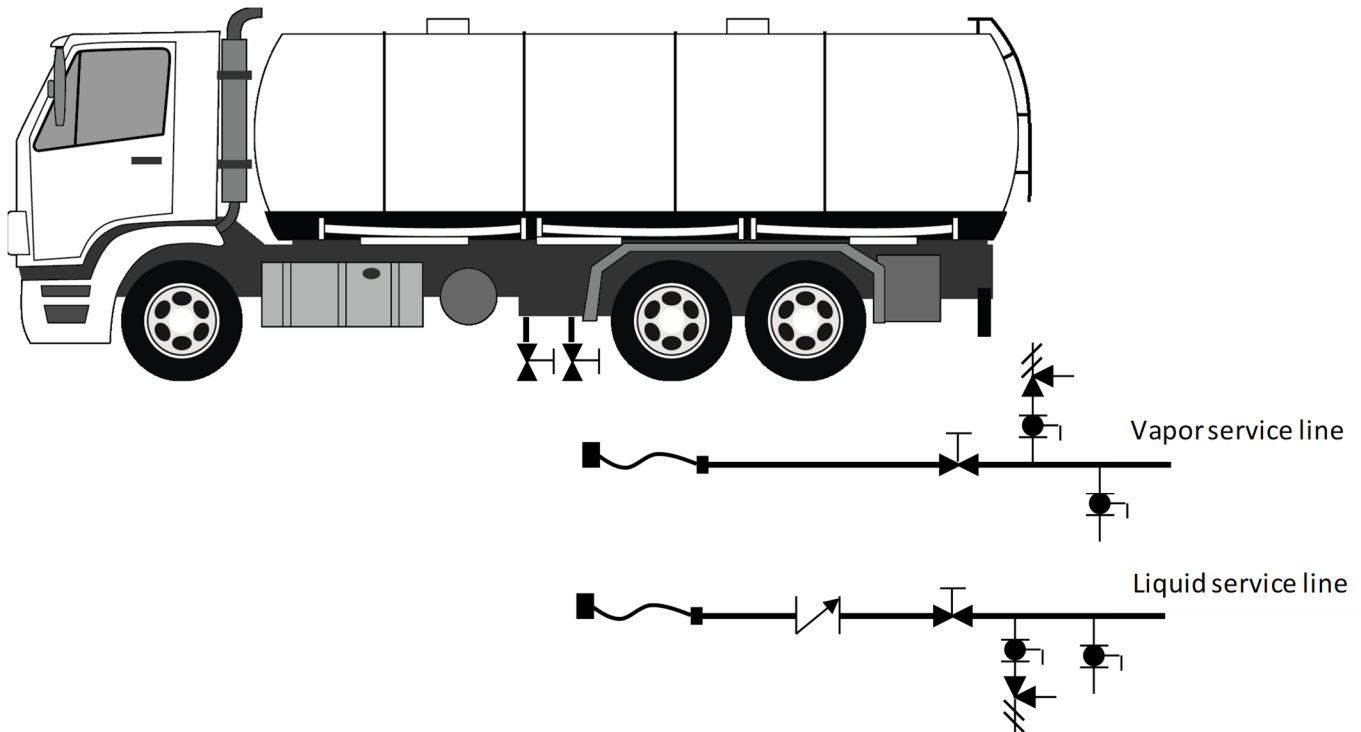

Figure_Apx D-1. Illustration of Transfer Lines Used During Tank Truck Unloading and Associated Equipment Assumed by EPA

D.4 Exposure Estimates

The vapor generation rate, G , or the total emission rate over time, can be calculated by aggregating emissions from all sources:

- During the transfer period, emissions are only due to leaks, with emission rate $G = E_L$.
- After transfer, during the disconnection of the hose(s), emissions are due to both leaks and escape of saturated vapor from the hose/transfer arm with emission rate $G = E_T + E_L$.

The vapor generation rate can then be used with the EPA Mass Balance Inhalation Model to estimate worker exposure during loading/unloading activities ([U.S. EPA, 2015b](#)). The EPA/OPPT Mass Balance Inhalation Model estimates the exposure concentration using Equation_Apx D-3 and the default parameters found in Table_Apx D-5 ([U.S. EPA, 2015b](#)). Table_Apx D-6 presents exposure estimates for CCl_4 using this approach. These estimates assume one unloading/loading event per day and CCl_4 is loaded/unloaded at 100% concentration. The loading operation occurs in an outdoor area with minimal

structure, with wind speeds of 9 mph (central tendency) or 5 mph (high-end).

Equation_Apx D-3

$$C_m = \frac{C_v}{V_m}$$

Table_Apx D-5. Parameters for Calculating Exposure Concentration Using the EPA/OPPT Mass Balance Model

Parameter	Parameter Description	Default Value	Unit
C _m	Mass concentration of chemical in air	Calculated from model equation	mg/m ³
C _v	Volumetric concentration of chemical in air	Calculated as the lesser of: $\frac{170,000 \times T \times G}{MW \times Q \times k}$ or $\frac{1,000,000 \times X \times VP}{760}$	ppm
T	Temperature of air	298	K
G	Vapor generation rate	E _L during transfer period E _T +E _L after transfer/during disconnection of hose/transfer arm	g/s
MW	Molecular weight of the chemical	153.82	g/mol
Q	Outdoor ventilation rate	237,600 (central tendency) 26,400 × (60 × $\frac{vz}{5280}$) (high-end)	ft ³ /min
vz	Air speed	440	ft/min
k	Mixing factor	0.5	dimensionless
X	Vapor pressure correction factor	1	dimensionless
VP	Vapor pressure of the pure chemical	115	torr
V _m	Molar volume	24.45 @ 25°C, 1 atm	L/mol

EPA calculated 8-hr TWA exposures as shown in Equation_Apx D-4. The 8-hr TWA exposure is the weighted average exposure during an entire 8-hr shift, assuming zero exposures during the remainder of the shift. EPA assumed one container is loaded/unloaded per shift: one tank truck per shift for the central tendency scenario and one railcar per shift for the high-end scenario.

Equation_Apx D-4

$$8 - hr TWA = \frac{(C_{m(leak\ only)} \times (h_{event} - t_{disconnect})) + (C_{m(leak\ and\ hose)} \times t_{disconnect})}{8} \times N_{cont}$$

Where:

- C_{m(leak only)} = Airborne concentration (mass-based) due to leaks during unloading while hose connected (mg/m³)
- C_{m(leak and hose)} = Airborne concentration (mass-based) due to leaks and displaced air during hose disconnection (mg/m³)

- h_{event} = Exposure duration of each loading/unloading event (hr/event); calculated as the inverse of the fill rate, r : 0.5 hr/event for tank trucks and 1 hr/event for railcars
- h_{shift} = Exposure duration during the shift (hr/shift); calculated as $h_{event} \times N_{cont}$: 0.5 hr/shift for tank trucks and 1 hr/shift for railcars
- $t_{disconnect}$ = Time duration to disconnect hoses/couplers (during which saturated vapor escapes from hose into air) (hr/event)
- N_{cont} = Number of containers loaded/unloaded per shift (event/shift); assumed one tank truck per shift for central tendency scenario and one railcar per shift for high-end scenario

Table_Apx D-6. Calculated Emission Rates and Resulting Exposures from the Tank Truck and Railcar Loading and Unloading Release and Inhalation Exposure Model for Carbon Tetrachloride

Scenario	E_L (g/s)	E_T (g/s)	$E_L + E_T$ (g/s)	C_m (leaks only) (mg/m ³)	C_m (leaks and hose vapor) (mg/m ³)	8-hr TWA (mg/m ³)
Central Tendency	0.049	0.008	0.057	0.85	0.99	0.057
High-End	0.059	0.071	0.130	1.85	4.08	0.30

Appendix E Dermal Exposure Assessment Approach and Parameters

This method was developed through review of relevant literature and consideration of existing exposure models, such as EPA/OPPT models, IH SkinPerm, and the European Centre for Ecotoxicology and Toxicology of Chemicals Targeted Risk Assessment (ECETOC TRA).

E.1 Incorporating the Effects of Evaporation

E.1.1 Modification of EPA/OPPT Models

Current EPA/OPPT dermal models do not incorporate the evaporation of material from the dermis. The dermal potential dose rate, D_{exp} (mg/day), is calculated as ([U.S. EPA, 2015b](#)):

Equation_Apx E-1

$$D_{exp} = S \times Q_u \times Y_{derm} \times FT$$

Where:

S is the surface area of contact (cm²; defaults: 535 cm² (central tendency); 1,070 cm² (high end) = full area of one hand (central tendency) or two hands (high end), a mean value for men > 21 yr ([U.S. EPA, 2011](#)), the highest exposed population)

Q_u is the quantity remaining on the skin (mg/cm²-event; defaults: 1.4 mg/cm²-event (central tendency); 2.1 mg/cm²-event (high end))

Y_{derm} is the weight fraction of the chemical of interest in the liquid ($0 \leq Y_{derm} \leq 1$)

FT is the frequency of events (integer number per day).

Here Q_u does not represent the quantity remaining after evaporation, but represents the quantity remaining after the bulk liquid has fallen from the hand that cannot be removed by wiping the skin (e.g., the film that remains on the skin).

One way to account for evaporation of a volatile solvent would be to add a multiplicative factor to the EPA/OPPT model to represent the proportion of chemical that remains on the skin after evaporation, f_{abs} ($0 \leq f_{abs} \leq 1$):

Equation_Apx E-2

$$D_{exp} = S \times (Q_u \times f_{abs}) \times Y_{derm} \times FT$$

This approach simply removes the evaporated mass from the calculation of dermal uptake. Evaporation is not instantaneous, but the EPA/OPPT model already has a simplified representation of the kinetics of dermal uptake.

E.2 Calculation of f_{abs}

Kasting and Miller ([2006](#)) developed a diffusion model to describe the absorption of volatile compounds applied to the skin. As part of the model, Kasting and Miller ([2006](#)) define a ratio of the liquid evaporation to absorption, χ . They derive the following definition of χ (which is dimensionless) at steady-state:

Equation_Apx E-3

$$\chi = 3.4 \times 10^{-3} u^{0.78} \frac{P_{vp} MW^{3.4}}{K_{oct}^{0.76} S_W}$$

Where:

u is the air velocity (m/s)

K_{oct} is the octanol:water partition coefficient

MW is the molecular weight

S_W is the water solubility ($\mu\text{g}/\text{cm}^3$)

P_{vp} is the vapor pressure (torr)

Chemicals for which $\chi \gg 1$ will largely evaporate from the skin surface, while chemicals for which $\chi \ll 1$ will be largely absorbed; $\chi = 1$ represents a balance between evaporation and absorption.

Equation_Apx E-3 is applicable to chemicals having a log octanol/water partition coefficient less than or equal to three ($\log K_{ow} \leq 3$)⁸. The equations that describe the fraction of the initial mass that is absorbed (or evaporated) are rather complex (Equations 20 and 21 of Kasting and Miller (2006)) but can be solved.

E.2.1 Small Doses (Case 1: $M_0 \leq M_{sat}$)

In the small dose scenario, the initial dose (M_0) is less than that required to saturate the upper layers of the stratum corneum ($M_0 \leq M_{sat}$), and the chemical is assumed to evaporate from the skin surface at a rate proportional to its local concentration.

For this scenario, Frasch (2012) calculated the fraction of applied mass that is absorbed, based on the infinite limit of time (i.e. infinite amount of time available for absorption after exposure):

Equation_Apx E-4

$$f_{abs} = \frac{m_{abs}(\infty)}{M_0} = \frac{2 + f\chi}{2 + 2\chi}$$

Where:

m_{abs} is the mass absorbed

M_0 is the initial mass applied

f is the relative depth of penetration in the stratum corneum ($f = 0.1$ can be assumed)

χ is as previously defined

Note the simple algebraic solution in Equation_Apx E-4 provides a theoretical framework for the total mass that is systemically absorbed after exposure to a small finite dose (mass/area) of chemical, which depends on the relative rates of evaporation, permeation, and the initial load. At “infinite time”, the applied dose is either absorbed or evaporated (Frasch, 2012). The finite dose is a good model for *splash-type exposure in the workplace* (Frasch and Bunge, 2015).

⁸ For simplification, Kasting and Miller (2006) does not consider the resistance of viable tissue layers underlying the stratum corneum, and the analysis is applicable to hydrophilic-to-moderately lipophilic chemicals. For small molecules, this limitation is equivalent to restricting the analysis to compounds where $\log K_{ow} \leq 3$.

The fraction of the applied mass that evaporates is simply the complement of that absorbed:

Equation_Apx E-5

$$\frac{m_{evap}(\infty)}{M_0} = 1 - f_{abs} = \frac{2\chi - f\chi}{2 + 2\chi}$$

Where:

m_{evap} is the mass evaporated

The fraction absorbed can also be represented as a function of dimensionless time τ (Dt/h^2), as shown in Equation_Apx E-6.

Equation_Apx E-6

$$f_{abs} = \frac{m_{abs}}{M_0} = 2 \sum_{n=1}^{\infty} \frac{1}{\lambda_n} (1 - e^{-\lambda_n^2 \tau}) \left(\frac{\chi^2 + \lambda_n^2}{\chi^2 + \lambda_n^2 + \chi} \right) \cdot \left(\frac{\cos(1-f)\lambda_n - \cos\lambda_n}{f \cdot \lambda_n} \right)$$

where the eigenvalues λ_n are the positive roots of the equation:

Equation_Apx E-7

$$\lambda_n \cdot \cot(\lambda_n) + \chi = 0$$

Equation_Apx E-6 and Equation_Apx E-7 must be solved analytically. It should be noted that the dimensionless time τ is not a representation of exposure duration for a work activity; rather, it represents the amount of time available for absorption after the initial exposure dose is applied. Since most dermal risk assessments are typically more concerned with the quantity absorbed, rather than the time course of absorption, the simple algebraic solution is recommended over the analytical solution.

E.2.2 Large Doses (Case 2: $M_0 > M_{sat}$)

For large doses ($M_0 > M_{sat}$), the chemical saturates the upper layers of the stratum corneum, and any remaining amount forms a residual layer (or pool) on top of the skin. The pool acts as a reservoir to replenish the top layers of the membrane as the chemical permeates into the lower layer. In this case, absorption and evaporation approach steady-state values as the dose is increased, similar to an infinite dose scenario.

The steady-state fraction absorbed can be approximated by Equation_Apx E-8.

Equation_Apx E-8

$$f_{abs}(\infty) = \frac{1}{\chi + 1}$$

Table_Apx E-1 presents the estimated absorbed fraction calculated using the steady-state approximation for large doses (Equation_Apx E-8 for carbon tetrachloride).

Table Apx E-1. Estimated Fraction Evaporated and Absorbed (f_{abs}) using Equation_Apx E-8

Chemical Name	Carbon Tetrachloride
CASRN	56-23-5
Molecular Formula	CCl ₄
Molecular Weight (g/mol)	153.82
P _{VP} (torr)	115
Universal gas constant, R (L*atm/K*mol)	0.0821
Temperature, T (K)	303
Log K _{ow}	2.83
K _{oct}	676.1
S _w (g/L)	0.793
S _w (µg/cm ³)	793
<i>Industrial Setting</i>	
u (m/s) ^a	0.1674
Evaporative Flux, χ	23.58
<i>Fraction Evaporated</i>	0.96
<i>Fraction Absorbed</i>	0.04
<i>Commercial Setting</i>	
u (m/s) ^a	0.0878
Evaporative Flux, χ	14.25
<i>Fraction Evaporated</i>	0.93
<i>Fraction Absorbed</i>	0.07

^a EPA used air speeds from Baldwin (1998): the 50th percentile of industrial occupational environments of 16.74 cm/s is used for industrial settings and the 50th percentile of commercial occupational environments of 8.78 cm/s is used for commercial settings.

E.3 Comparison of f_{abs} to FR_{abs} in the Consumer Exposure Model (CEM)

The *Dermal Dose from Product Applied to Skin, Fraction Absorbed Model* (P_DER2a) within CEM Version 2.1.6 also uses a fraction absorbed parameter to estimate dermal dose. In this model, a fraction absorbed parameter (FR_{abs}) is applied to a potential dose (i.e., amount of chemical retained on the skin) to estimate the amount of chemical that penetrates the skin. P_DER2a references Frasch and Bunge (2015) to estimate the fraction absorbed using a simple algebraic approximation at *infinite time following a transient exposure*:

Equation_Apx E-9

$$FR_{abs} = \frac{3 + \chi \left[1 - \exp\left(-a_1 \frac{t_{exp}}{t_{lag}}\right) \right]}{3(1 + \chi)}$$

Where:

χ is the ratio of the evaporation rate from the stratum corneum surface to the dermal absorption rate through the stratum corneum (unitless, see Equation 90 of CEM)

α is constant (2.906)

t_{exp} is the exposure time (h)

t_{lag} is the lag time for chemical transport through the stratum corneum (h, see Equation 89 of CEM)

The Frasch and Bunge (2015) method is one of *transient dermal exposure* where the skin is exposed to a chemical for a finite duration, after which the chemical is removed and no residue remains on the skin. At the end of the exposure period, the chemical within the skin can still enter the systemic circulation. This transient exposure model can represent exposure from bathing or showering with contaminated water, where “dermal absorption proceeds for the duration of exposure, but once the bath or shower has ended, contaminant residing within the skin may still be absorbed by the body while some may evaporate into the surrounding air” (Frasch and Bunge, 2015).

Due to lack of available information on carbon tetrachloride, data and modeling for highly volatile chemicals such as 1-bromopropane and methylene chloride were followed. For these highly volatile chemicals, the value of FR_{abs} varies from zero (for small value of t_{exp}) to a maximum of one-third. Figure_Apx E-1 below provides a graphical representation of fraction absorbed (FR_{abs}) over time for 1-bromopropane. It should be noted that the steady-state fraction absorbed in this transient exposure scenario is substantially higher than the theoretical fraction absorbed for a large dose scenario presented in Table_Apx E-1.

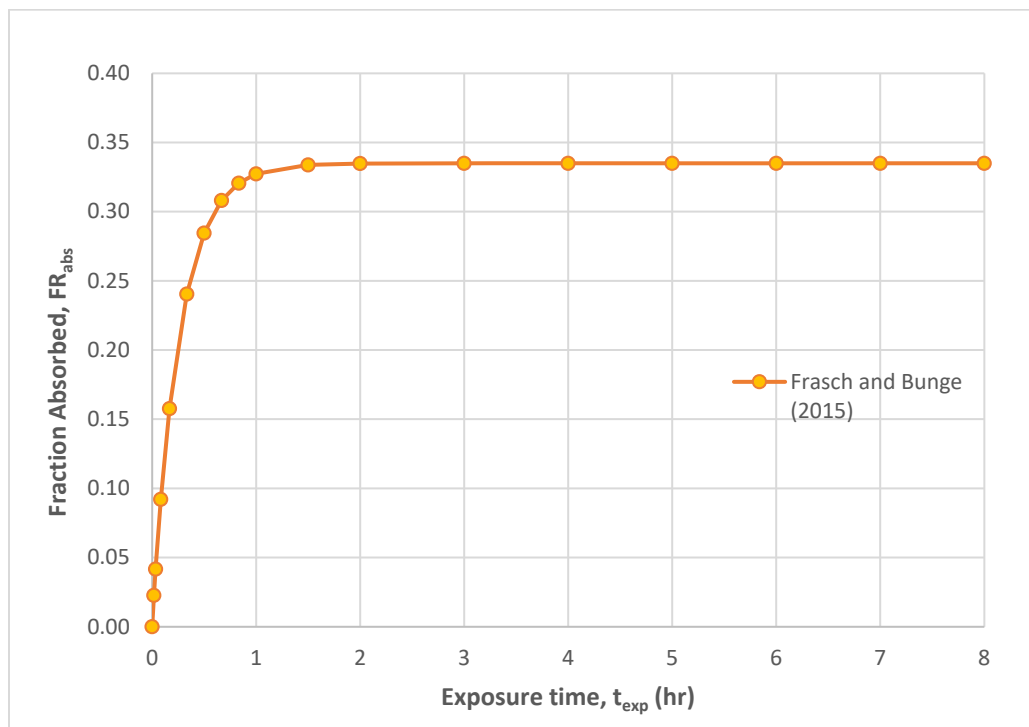

Figure_Apx E-1. Estimated Fraction Absorbed for Highly Volatile Chemicals (CEM Equation)

It is important to note that FR_{abs} refers to the post-exposure absorbed fraction of the amount of chemical present in the skin membrane at the end of the exposure time; it does not account for the amount of

chemical that has been absorbed into the body from the entire transient exposure. Frasch (2015) presents equations to estimate the total mass absorbed as a function of exposure time, as an infinite series summation, when experimental values for the permeability coefficient (K_p) and lag time (t_{lag}) are available.

E.4 Comparison of f_{abs} to Experimental Values for Highly Volatile Chemicals

Sections E.2 and E.3 present theoretical frameworks for estimating the fraction of volatile chemical absorbed in finite dose, infinite dose, and transient exposure scenarios. It is unclear whether these frameworks have been validated against measured data for the specific chemicals of current OPPT interest. Where available, experimental studies and actual measurements of absorbed dose are preferred over theoretical calculations.

In a 2011 study, Frasch (2011) tested dermal absorption characteristics of 1-bromopropane. For the finite dose scenario, Frasch (2011) determined that unoccluded exposure resulted in less than 0.2 percent of applied 1-bromopropane dose penetrated the skin – a value substantially lower than the theoretical ~6 percent absorbed estimated using Equation_Apx E-8. While this discrepancy is unexplained, the Frasch (2011) study recognized the large standard deviation of certain experimental results, and the difficulty of spreading a small, rapidly evaporating dose of 1-bromopropane evenly over the skin surface. Frasch (2011) also raised the possibility that 1-bromopropane may dehydrate the stratum corneum, thereby decreasing the skin permeability after initial exposure.

E.5 Potential for Occlusion

Gloves can prevent the evaporation of volatile chemicals from the skin, resulting in occlusion. Chemicals trapped in the glove may be broadly distributed over the skin (increasing S in Equation_Apx E-1), or if not distributed within the glove, the chemical mass concentration on the skin at the site of contamination may be maintained for prolonged periods of time (increasing Q_u in Equation_Apx E-1). Conceptually, occlusion is similar to the “infinite dose” study design used in *in vitro* and *ex vivo* dermal penetration studies, in which the dermis is exposed to a large, continuous reservoir of chemical.

The impact of occlusion on dermal uptake is complex: continuous contact with the chemical may degrade skin tissues, increasing the rate of uptake, but continuous contact may also saturate the skin, slowing uptake (Dancik et al., 2015). These phenomena are dependent upon the chemical, the vehicle and environmental conditions. It is probably not feasible to incorporate these sources of variability in a screening-level population model of dermal exposure without chemical-specific studies.

Existing EPA/OPPT dermal models (Equation_Apx E-1) could theoretically be modified to account for the increased surface area and/or increased chemical mass in the glove. This could be achieved through a multiplicative variable (such as used in Equation_Apx E-2 to account for evaporative loss) or a change in the default values of S and/or Q_u . It may be reasonable to assume that the surface area of hand in contact with the chemical, S , is the area of the whole hand owing to the distribution of chemical within the glove. Since Q_u reflects the film that remains on the skin (and cannot be wiped off), a larger value should be used to reflect that the liquid volume is trapped in the glove, rather than falling from the hand. Alternatively, the product $S \times Q_u$ ($\text{cm}^2 \times \text{mg}/\text{cm}^2\text{-event}$) could be replaced by a single variable representing the mass of chemical that deposits inside the glove per event, M (mg/event):

Equation_Apx E-10

$$D_{exp} = M \times Y_{derm} \times FT$$

Garrod (2001) surveyed contamination by involatile components of non-agricultural pesticide products inside gloves across different job tasks and found that protective gloves were nearly always contaminated inside. While the study does not describe the exact mechanism in which the contamination occurs (e.g. via the cuff, permeation, or penetration through imperfections in glove materials), it quantified inner glove exposure as “amount of product per unit time”, with a median value of 1.36 mg product per minute, a 75th percentile value of 4.21 mg/min, and a 95th percentile value of 71.9 mg/min. It is possible to use these values to calculate the value of M, i.e. mass of chemical that deposits inside the glove, if the work activity duration is known.

Assuming an activity duration of one hour, the 50th and 95th percentile values translate to 81.6 mg and 4,314 mg of inner glove exposure. While these values may be used as default for M in Equation_Apx E-10, EPA notes the significant difference between the 50th and 95th percentile deposition, with the 95th percentile value being two times more conservative than the defaults for the EPA/OPPT 2-Hand Dermal Exposure Model (where the product $S \times Q_u$ is 2,247 mg/event) (U.S. EPA, 2015b). Given the significant variability in inner glove exposure and lack of information on the specific mechanism in which the inner glove contamination occurs, EPA addresses the occlusion scenario in combination with other glove contamination and permeation factors through the use of a protection factor, as described in the next section.

EPA does not expect occlusion scenarios to be a reasonable occurrence for all conditions of use. Specifically, occlusion is not expected at sites using chemicals in closed systems where the only potential of dermal exposure is during the connecting/disconnecting of hoses used for unloading/loading of bulk containers (e.g., tank trucks or rail cars) or while collecting quality control samples including manufacturing sites, repackaging sites, sites processing the chemical as a reactant, formulation sites, and other similar industrial sites. Occlusion is also not expected to occur at highly controlled sites, such as electronics and inorganic and organic chemicals manufacturing sites, where, due to purity requirements, the use of engineering controls is expected to limit potential dermal exposures. EPA also does not expect occlusion at sites where contact with bulk liquid chemical is not expected such as aerosol degreasing sites where workers are only expected to handle the aerosol cans containing the chemical and not the actual bulk liquid chemical.

EPA expects occlusion to be a reasonable occurrence at sites where workers may come in contact with bulk liquid chemical and handle the chemical in open systems. This includes conditions of use such as vapor degreasing, cold cleaning, and dry cleaning where workers are expected to handle bulk chemical during cleanout of spent solvent and addition of fresh solvent to equipment. Similarly, occlusion may occur at coating or adhesive application sites when workers replenish application equipment with liquid coatings or adhesives.

E.6 Incorporating Glove Protection

Data about the frequency of effective glove use – that is, the proper use of effective gloves – is very limited in industrial settings. Initial literature review suggests that there is unlikely to be sufficient data to justify a specific probability distribution for effective glove use for a chemical or industry. Instead, the impact of effective glove use should be explored by considering different percentages of

effectiveness (e.g., 25% vs. 50% effectiveness).

Gloves only offer barrier protection until the chemical breaks through the glove material. Using a conceptual model, Cherrie (2004) proposed a glove workplace protection factor – the ratio of estimated uptake through the hands without gloves to the estimated uptake through the hands while wearing gloves: this protection factor is driven by flux, and thus varies with time. The ECETOC TRA model represents the protection factor of gloves as a fixed, assigned protection factor equal to 5, 10, or 20 (Marquart et al., 2017). Where, similar to the APR for respiratory protection, the inverse of the protection factor is the fraction of the chemical that penetrates the glove.

The protection afforded by gloves can be incorporated into the EPA/OPPT model (Equation_Apx E-1) by modification of Q_u with a protection factor, PF (unitless, $PF \geq 1$):

Equation_Apx E-11

$$D_{exp} = S \times \frac{Q_u}{PF} \times Y_{derm} \times FT$$

Given the limited state of knowledge about the protection afforded by gloves in the workplace, it is reasonable to utilize the PF values of the ECETOC TRA model (Marquart et al., 2017), rather than attempt to derive new values. Table_Apx E-2 presents the PF values from ECETOC TRA model (version 3). In the exposure data used to evaluate the ECETOC TRA model, Marquart et al. (2017) reported that the observed glove protection factor was 34, compared to PF values of 5 or 10 used in the model.

Table_Apx E-2. Exposure Control Efficiencies and Protection Factors for Different Dermal Protection Strategies from ECETOC TRA v3

Dermal Protection Characteristics	Affected User Group	Indicated Efficiency (%)	Protection Factor, PF
a. Any glove / gauntlet without permeation data and without employee training	Both industrial and professional users	0	1
b. Gloves with available permeation data indicating that the material of construction offers good protection for the substance		80	5
c. Chemically resistant gloves (i.e., as b above) with “basic” employee training		90	10
d. Chemically resistant gloves in combination with specific activity training (e.g., procedure for glove removal and disposal) for tasks where dermal exposure can be expected to occur	Industrial users only	95	20

E.7 Proposed Dermal Dose Equation

Accounting for all parameters above, the proposed, overall equation for estimating dermal exposure is:

Equation_Apx E-12

$$D_{exp} = S \times \frac{(Q_u \times f_{abs})}{PF} \times Y_{derm} \times FT$$

EPA presents exposure estimates for the following deterministic dermal exposure scenarios:

- Dermal exposure without the use of protective gloves (Equation_Apx E-12, PF = 1)
- Dermal exposure with the use of protective gloves (Equation_Apx E-12, PF = 5)
- Dermal exposure with the use of protective gloves and employee training (Equation_Apx E-12, PF = 20 for industrial users and PF = 10 for professional users)
- Dermal exposure with occlusion (Equation_Apx E-10)

EPA assumes the following parameter values for Equation_Apx E-12 in addition to the parameter values presented in Table_Apx E-3:

- S, the surface area of contact: 535 cm² (central tendency) and 1,070 cm² (high end), representing the total surface area of one and two hands, respectively (note that EPA has no data on actual surface area of contact for any OES).
- Q_u, the quantity remaining on the skin: 1.4 mg/cm²-event (central tendency) and 2.1 mg/cm²-event (high-end). These are the midpoint value and high end of range default value, respectively, used in the EPA/OPPT dermal contact with liquids models ([U.S. EPA, 2015b](#)).
- Y_{derm}, the weight fraction of the chemical of interest in the liquid: EPA will assess a unique value of this parameter for each occupational scenario or group of similar occupational scenarios.
- FT, the frequency of events: 1 event per day. Equation_Apx E-12 shows a linear relationship between FT and D_{exp}; however, this fails to account for time between contact events. Since the chemical simultaneously evaporates from and absorbs into the skin, the dermal exposure is a function of both the number of contact events per day and the time between contact events. EPA did not identify information on how many contact events may occur and the time between contact events. Therefore, EPA assumes a single contact event per day for estimating dermal exposures.

For Equation_Apx E-10, EPA assumes the quantity of liquid occluded underneath the glove (*M*) is equal to the product of the entire surface area of contact (*S* = 1,070 cm²) and the assumed quantity of liquid remaining on the skin (*Q_u* = 2.1 mg/cm²-event), which is equal to 2,247 mg/event. See discussion in Section E.5.

E.8 Equations for Calculating Acute and Chronic (Non-Cancer and Cancer) Dermal Doses

Equation E-12 estimates dermal potential dose rates (mg/day) to workers in occupational settings. The potential dose rates are then used to calculate acute retained doses (ARD), and chronic retained doses (CRD) for non-cancer and cancer risks.

Acute retained doses are calculated using Equation E-13.

Equation_Apx E-13

$$ARD = \frac{D_{exp}}{BW}$$

Where:

- ARD = acute retained dose (mg/kg-day)
- D_{exp} = dermal potential dose rate (mg/kg)
- BW = body weight (kg)

CRD is used to estimate exposures for non-cancer and cancer risks. CRD is calculated as follows:

Equation_Apx E-14

$$CRD = \frac{D_{exp} \times EF \times WY}{BW \times (AT \text{ or } AT_c)}$$

Equation_Apx E-15

$$AT = WY \times 250 \frac{\text{day}}{\text{yr}}$$

Equation_Apx E-16

$$AT_c = LT \times 250 \frac{\text{day}}{\text{yr}}$$

Where:

- CRD = Chronic retained dose used for chronic non-cancer or cancer risk calculations
- EF = Exposure frequency (day/yr)
- WY = Working years per lifetime (yr)
- AT = Averaging time (day) for chronic, non-cancer risk
- AT_c = Averaging time (day) for cancer risk
- LT = Lifetime years (yr) for cancer risk

summarizes the default parameter values used to calculate each of the above acute or chronic exposure estimates. Where multiple values are provided for EF, it indicates that EPA may have used different values for different conditions of use. The rationales for these differences are described below in this section.

Table_Apx E-3. Carbon Tetrachloride Parameter Values Used to Calculate Acute or Chronic Exposure Estimates

Parameter Name	Symbol	Value	Unit
Exposure Frequency	EF	250 125 to 150 (DoD analysis only)	days/yr
Working years	WY	31 (50 th percentile) 40 (95 th percentile)	years
Lifetime Years, cancer	LT	78	years
Body Weight	BW	80 (average adult worker) 72.4 (female of reproductive age)	kg
Averaging Time, non-cancer	AT	7,750 (central tendency) ^a 10,000 (high-end) ^b	day
Averaging Time, cancer	AT _c	19,500	day

^a Calculated using the 50th percentile value for working years (WY)

^b Calculated using the 95th percentile value for working years (WY)

Exposure Frequency (EF)

EPA generally uses an exposure frequency of 250 days per year with two notable exceptions: dry cleaning and DoD uses. EPA assumed dry cleaners may operate between five and six days per week and 50 to 52 weeks per year resulting in a range of 250 to 312 annual working days per year (AWD). Taking into account fractional days exposed (f) resulted in an exposure frequency (EF) of 258 at the 50th percentile and 293 at the 95th percentile. For the two DoD uses, information was provided indicating process frequencies of two to three times per week (oil analysis) and two to three times per month (water pipe repair). EPA used the maximum frequency for high-end estimates and the midpoint frequency for central tendency estimates. For the oil analysis use this resulted in 125 days/yr at the central tendency and 150 days/yr at the high-end. For the water pipe repair, this resulted in 30 days/yr at the central tendency and 36 days/yr at the high-end.

EF is expressed as the number of days per year a worker is exposed to the chemical being assessed. In some cases, it may be reasonable to assume a worker is exposed to the chemical on each working day. In other cases, it may be more appropriate to estimate a worker's exposure to the chemical occurs during a subset of the worker's annual working days. The relationship between exposure frequency and annual working days can be described mathematically as follows:

Equation_Apx E-17

$$EF = f \times AWD$$

Where:

EF = exposure frequency, the number of days per year a worker is exposed to the chemical (day/yr)

f = fractional number of annual working days during which a worker is exposed to the

chemical (unitless)

AWD = annual working days, the number of days per year a worker works (day/yr)

U.S. BLS (2016) provides data on the total number of hours worked and total number of employees by each industry NAICS code. These data are available from the 3- to 6-digit NAICS level (where 3-digit NAICS are less granular and 6-digit NAICS are the most granular). Dividing the total, annual hours worked by the number of employees yields the average number of hours worked per employee per year for each NAICS.

EPA has identified approximately 140 NAICS codes applicable to the multiple conditions of use for the ten chemicals undergoing risk evaluation. For each NAICS code of interest, EPA looked up the average hours worked per employee per year at the most granular NAICS level available (i.e., 4-digit, 5-digit, or 6-digit). EPA converted the working hours per employee to working days per year per employee assuming employees work an average of eight hours per day. The average number of days per year worked, or AWD, ranges from 169 to 282 days per year, with a 50th percentile value of 250 days per year. EPA repeated this analysis for all NAICS codes at the 4-digit level. The average AWD for all 4-digit NAICS codes ranges from 111 to 282 days per year, with a 50th percentile value of 228 days per year. 250 days per year is approximately the 75th percentile. In the absence of industry- and PCE-specific data, EPA assumes the parameter f is equal to one for all conditions of use except dry cleaning. Dry cleaning used a uniform distribution from 0.8 to 1 for f . The 0.8 value was derived from the observation that the weighted average of 200 day/yr worked (from BLS/Census) is 80% of the standard assumption that a full-time worker works 250 day/yr. The maximum of 1 is appropriate as dry cleaners may be family owned and operated and some workers may work as much as every operating day.

Working Years (WY)

EPA has developed a triangular distribution for working years. EPA has defined the parameters of the triangular distribution as follows:

- Minimum value: BLS CPS tenure data with current employer as a low-end estimate of the number of lifetime working years: 10.4 years;
- Mode value: The 50th percentile tenure data with all employers from SIPP as a mode value for the number of lifetime working years: 36 years; and
- Maximum value: The maximum average tenure data with all employers from SIPP as a high-end estimate on the number of lifetime working years: 44 years.

This triangular distribution has a 50th percentile value of 31 years and a 95th percentile value of 40 years. EPA uses these values for central tendency and high-end ADC and LADC calculations, respectively.

The U.S. BLS (2014) provides information on employee tenure with *current employer* obtained from the Current Population Survey (CPS). CPS is a monthly sample survey of about 60,000 households that provides information on the labor force status of the civilian non-institutional population age 16 and over; CPS data are released every two years. The data are available by demographics and by generic industry sectors but are not available by NAICS codes.

The U.S. Census ([2019a](#)) Survey of Income and Program Participation (SIPP) provides information on *lifetime tenure with all employers*. SIPP is a household survey that collects data on income, labor force participation, social program participation and eligibility, and general demographic characteristics through a continuous series of national panel surveys of between 14,000 and 52,000 households ([U.S. Census Bureau, 2019b](#)). EPA analyzed the 2008 SIPP Panel Wave 1, a panel that began in 2008 and covers the interview months of September 2008 through December 2008 ([U.S. Census Bureau, 2019a, b](#)). For this panel, lifetime tenure data are available by Census Industry Codes, which can be cross-walked with NAICS codes.

SIPP data include fields for the industry in which each surveyed, employed individual works (TJBIND1), worker age (TAGE), and years of work experience *with all employers* over the surveyed individual’s lifetime.⁹ Census household surveys use different industry codes than the NAICS codes used in its firm surveys, so these were converted to NAICS using a published crosswalk ([U.S. Census Bureau, 2013](#)). EPA calculated the average tenure for the following age groups: 1) workers age 50 and older; 2) workers age 60 and older; and 3) workers of all ages employed at time of survey. EPA used tenure data for age group “50 and older” to determine the high-end lifetime working years, because the sample size in this age group is often substantially higher than the sample size for age group “60 and older”. For some industries, the number of workers surveyed, or the *sample size*, was too small to provide a reliable representation of the worker tenure in that industry. Therefore, EPA excluded data where the sample size is less than five from our analysis.

Table_Apx E-4 summarizes the average tenure for workers age 50 and older from SIPP data. Although the tenure may differ for any given industry sector, there is no significant variability between the 50th and 95th percentile values of average tenure across manufacturing and non-manufacturing sectors.

Table_Apx E-4. Overview of Average Worker Tenure from U.S. Census SIPP (Age Group 50+)

Industry Sectors	Working Years			
	Average	50 th Percentile	95 th Percentile	Maximum
All industry sectors relevant to the 10 chemicals undergoing risk evaluation	35.9	36	39	44
Manufacturing sectors (NAICS 31-33)	35.7	36	39	40
Non-manufacturing sectors (NAICS 42-81)	36.1	36	39	44

Source: ([U.S. Census Bureau, 2019a](#))

Note: Industries where sample size is less than five are excluded from this analysis.

BLS CPS data provides the median years of tenure that wage and salary workers had been with their current employer. Table_Apx E-5 presents CPS data for all demographics (men and women) by age group from 2008 to 2012. To estimate the low-end value on number of working years, EPA uses the most recent (2014) CPS data for workers age 55 to 64 years, which indicates a median tenure of 10.4 years with their current employer. The use of this low-end value represents a scenario where workers are only exposed to the chemical of interest for a portion of their lifetime working years, as they may change jobs or move from one industry to another throughout their career.

⁹ To calculate the number of years of work experience EPA took the difference between the year first worked (TMAKMNYR) and the current data year (i.e., 2008). EPA then subtracted any intervening months when not working (ETIMEOFF).

Table Apx E-5. Median Years of Tenure with Current Employer by Age Group

Age	January 2008	January 2010	January 2012	January 2014
16 years and over	4.1	4.4	4.6	4.6
16 to 17 years	0.7	0.7	0.7	0.7
18 to 19 years	0.8	1.0	0.8	0.8
20 to 24 years	1.3	1.5	1.3	1.3
25 years and over	5.1	5.2	5.4	5.5
25 to 34 years	2.7	3.1	3.2	3.0
35 to 44 years	4.9	5.1	5.3	5.2
45 to 54 years	7.6	7.8	7.8	7.9
55 to 64 years	9.9	10.0	10.3	10.4
65 years and over	10.2	9.9	10.3	10.3

Source: ([U.S. BLS, 2014](#))

Lifetime Years (LT)

EPA assumes a lifetime of 78 years for all worker demographics.

Body Weight (BW)

EPA assumes a body weight of 80 kg for average adult workers and 72.4 kg for females of reproductive age.